



origami *furniture*

Decorate the Perfect Doll's House
with 25 Stylish Projects

DUY NGUYEN



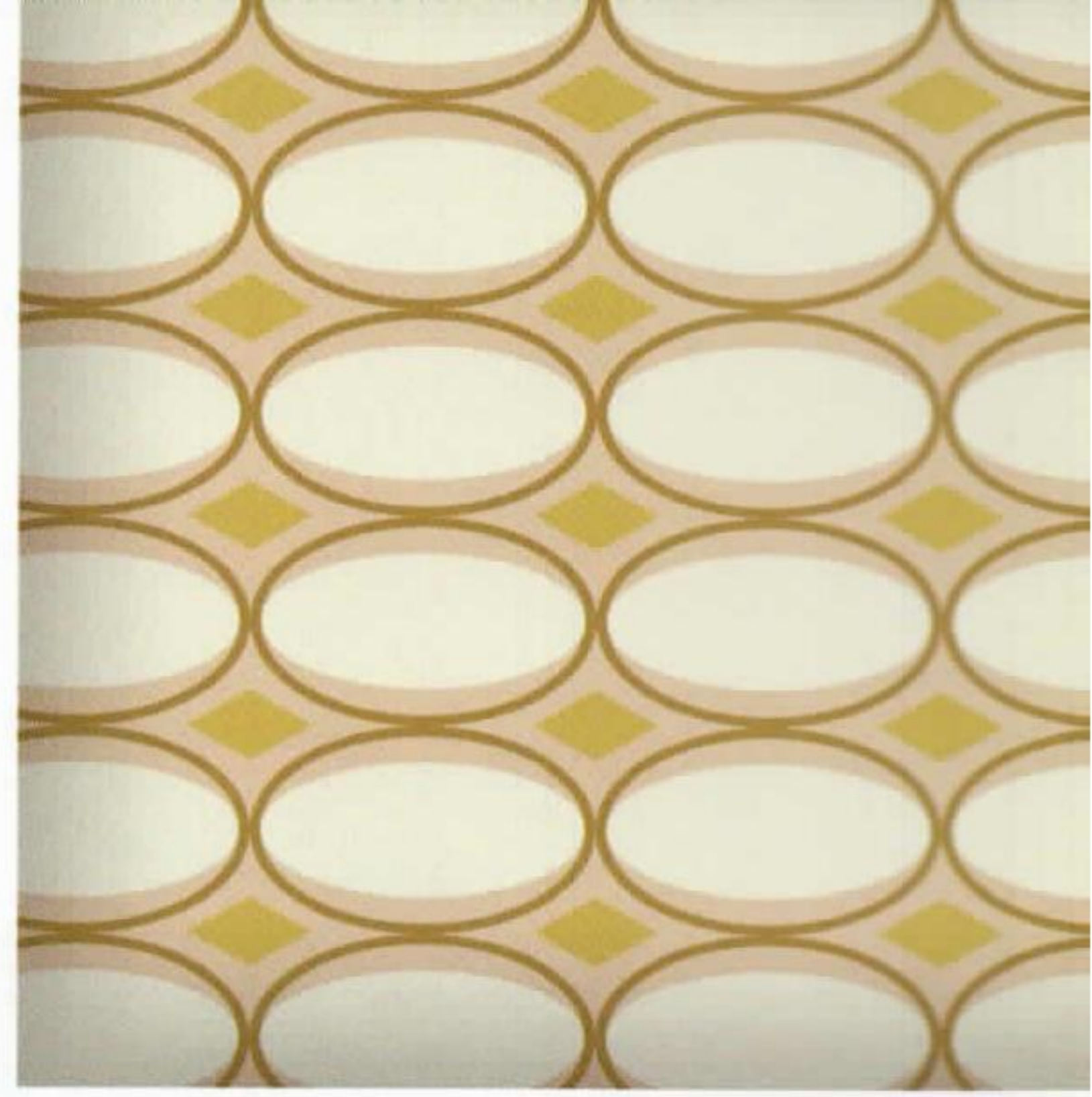

origami *furniture*

Decorate the Perfect Doll's House
with 25 Stylish Projects

DUY NGUYEN





about the author

Master origami artist Duy Nguyen has written over 18 books, including *Uber Origami*, *Zombigami*, and *Origami with Dollar Bills*. He lives in Everett, Washington.

acknowledgments

I'd like to thank my daughter, Natalie Nguyen, for all her help with this book. Natalie has been by my side for the last few years, helping me teach at origami workshops. Her love of origami shows in all the wonderful projects she's worked with me to create. Here's to the Paper Arts Dream Team!





An Imprint of Sterling Publishing
1166 Avenue of the Americas
New York, NY 10036

STERLING and the distinctive Sterling logo are
registered trademarks of Sterling Publishing Co., Inc.

© 2015 by Sterling Publishing Co., Inc.

All rights reserved. No part of this publication may be reproduced,
stored in a retrieval system, or transmitted, in any form or by
any means (including electronic, mechanical, photocopying, recording,
or otherwise) without prior written permission from the publisher.

Cover design by David Ter-Avanesyan
Interior design by Sharon Jacobs

ISBN 978-1-4547-0906-0

Distributed in Canada by Sterling Publishing
c/o Canadian Manda Group, 664 Annette Street
Toronto, Ontario, Canada M6S 2C8

Distributed in the United Kingdom by GMC Distribution Services
Castle Place, 166 High Street, Lewes, East Sussex, England BN7 1XU

Distributed in Australia by Capricorn Link (Australia) Pty. Ltd.
P.O. Box 704, Windsor, NSW 2756, Australia

For information about custom editions, special sales, and premium
and corporate purchases, please contact Sterling Special Sales
at 1-800-805-5489 or specialsales@sterlingpublishing.com.

Manufactured in China

2 4 6 8 10 9 7 5 3 1

contents

Introduction 9

Symbols & Basic Folds

Legend 10
Valley Fold | Mountain Fold | Kite Fold 10
Inside Reverse Fold 11
Outside Reverse Fold 12
Pleat Fold | Pleat Fold Reverse 13
Squash Fold 1 | Squash Fold 2 14
Inside Crimp Fold | Outside Crimp Fold 15
Sink Fold 16
Bird Base 17

7 Rooms | 25 Pieces

1 Living Room 19	4 Office 55	6 Bathroom 101
Chair 20	Office Chair 56	Bathtub 102
Coffee Table 22	Bookcase 59	Sink (Basin) 104
Couch 24	Computer 63	Toilet 106
End Table 30	Floor Lamp 65	
2 Dining Room 35	Lounge Chair 70	7 Vanity Set 113
Dinette Chair 36	Computer Desk 73	Vanity Table 114
Dinette Table 40		Vanity Chair 119
3 Kitchen 45	5 Bedroom 77	8 Accessories 123
Bar Stool 46	Divan Bed 78	Television 124
Refrigerator 49	Dresser 83	Table Lamp 128
	Wardrobe 91	Telephone 133



Introduction

This collection combines the best elements of both origami and doll houses. In terms of the latter, the real fun with miniature homes is in the furniture. This is where you can let your imagination run wild, as you consider the infinite configurations possible with an assortment of tables, chairs, lamps and other household furnishings. I have created these elements through the art of origami, and they can be enjoyed by anyone who wishes to re-create these works. It was important for me to utilize similar folding techniques for all of these models so they would have a consistent look. Still, there is lots of opportunity to infuse them with your own personality, by your choice of paper sizes, colors, and even textures. When you are comfortable with the folding sequences, you can even modify the locations of the folds. Many of the steps purposely do not have specific reference points, leaving a chance for you to give your furniture its own personality. Throughout the course of these projects, there are plenty of folds to keep your fingers busy for hours. Enjoy!

paper tips

The best origami paper is very thin, will keep a crease well, and folds flat. You can use plain white paper, colored paper, or wrapping paper. Regular printer paper may be too heavy to make the many tight folds needed. Origami paper is available at craft and hobby shops. Unless otherwise indicated, the paper that is used to make this furniture is 6 x 6 inches. If you are having trouble, it may be easier to start with larger paper.

glue tips









Use an easy-flowing paper glue. Use it sparingly; do not soak the paper. A toothpick makes a good applicator. After finishing a project, use glue as needed to prevent unfolding. Give the glue time to dry. Avoid using glue sticks.

technique tips

Fold with care. Position the paper, especially at corners, precisely. Make sure that edges line up before creasing a fold. Then use a fingernail to make a clean, flat crease. As you make folds, look at the next diagram for guidance. As you become more familiar with the folds, it becomes easier and easier to create origami projects.

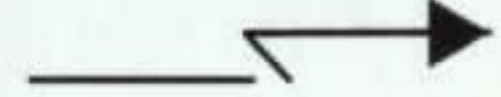
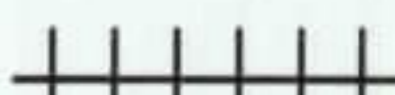
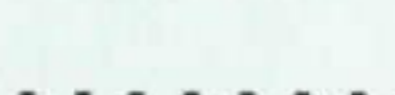
► symbols & basic folds

legend

 VALLEY FOLD	 INSIDE REVERSE FOLD	 CREASED LINE (white line)
 MOUNTAIN FOLD	 SCALE	 PLEAT FOLD
 CUT	 SINK FOLD	 FOLD DIRECTION
 TURN OVER OR ROTATE	 FOLD AND UNFOLD	 PULL DIRECTION

basic folds

VALLEY FOLD

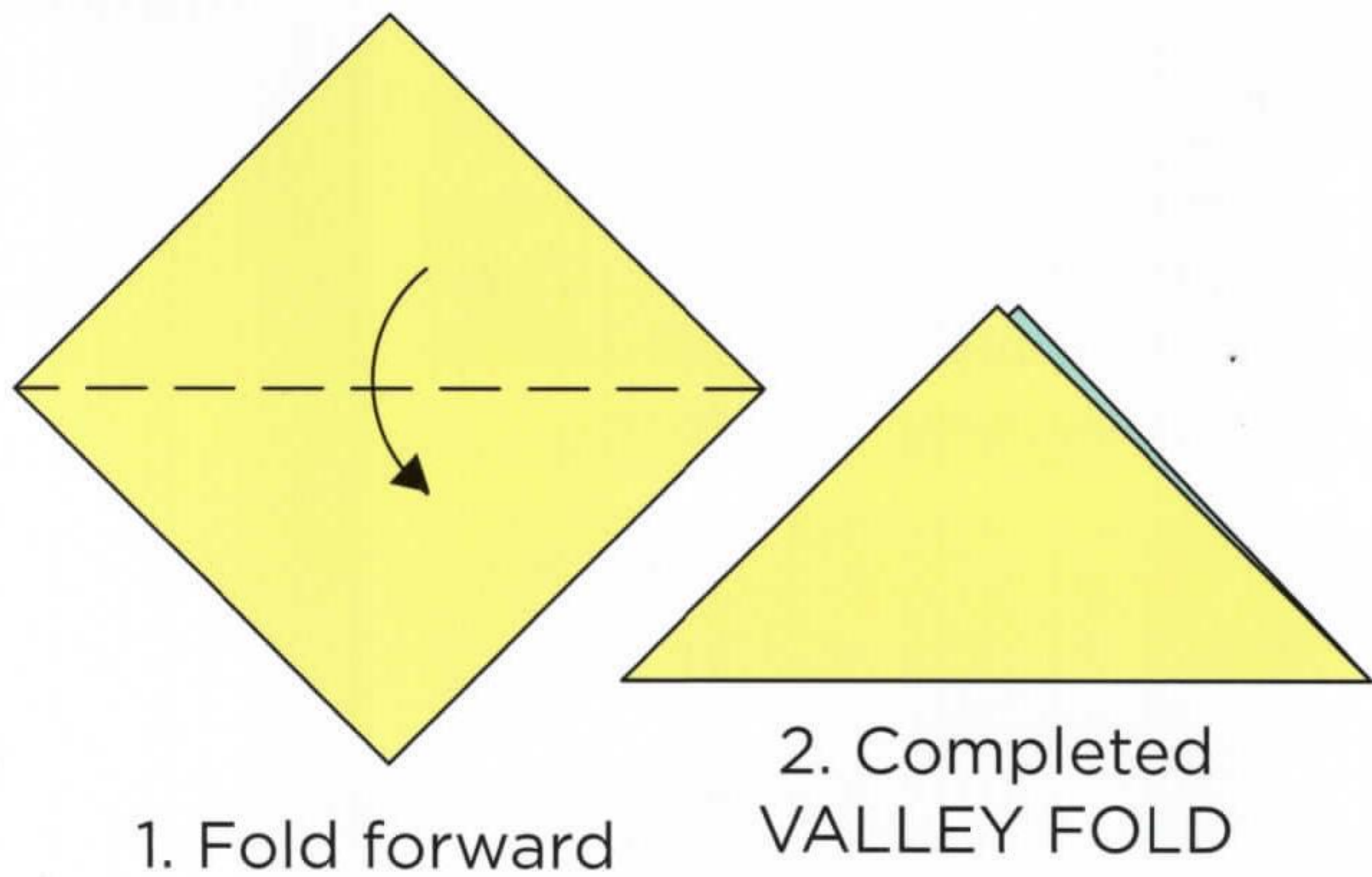

MOUNTAIN FOLD

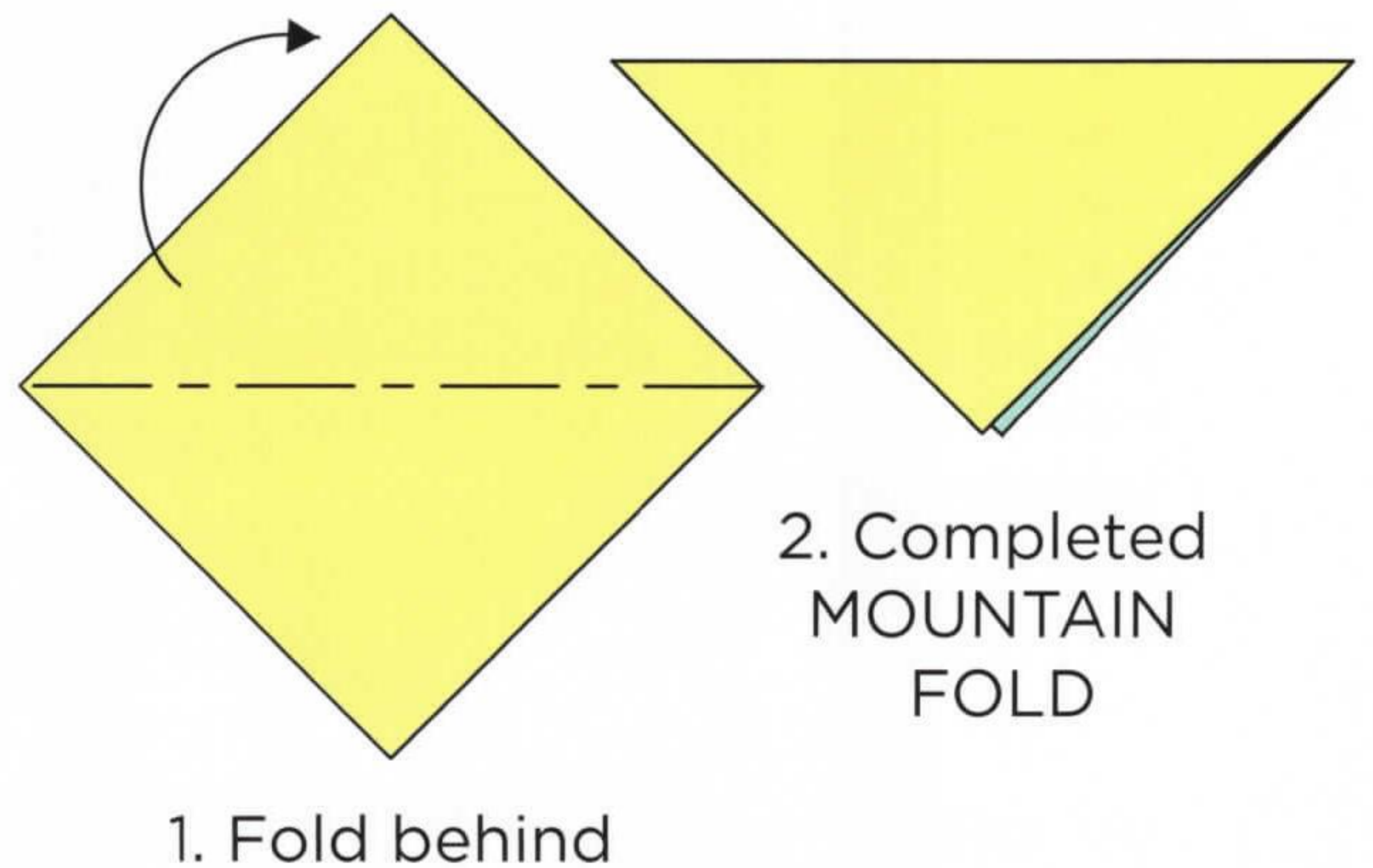

KITE FOLD

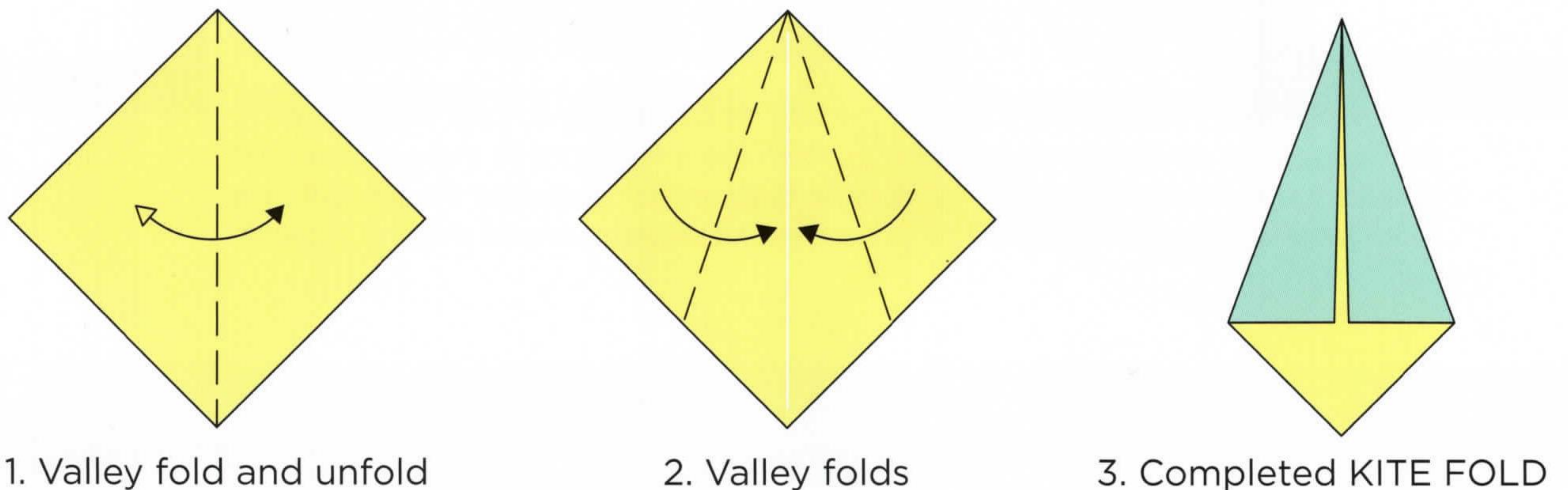

INSIDE REVERSE FOLD

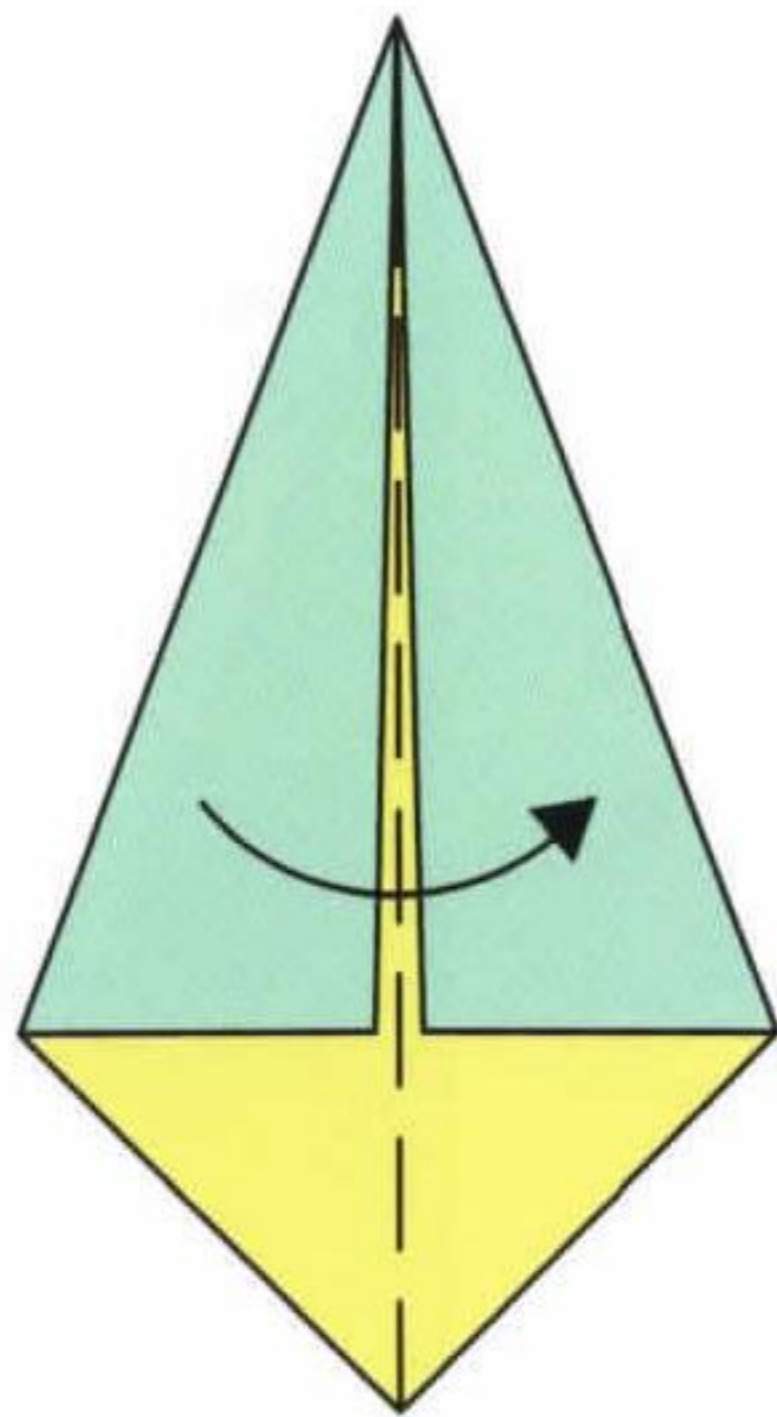

1. Kite fold, then Valley fold in half

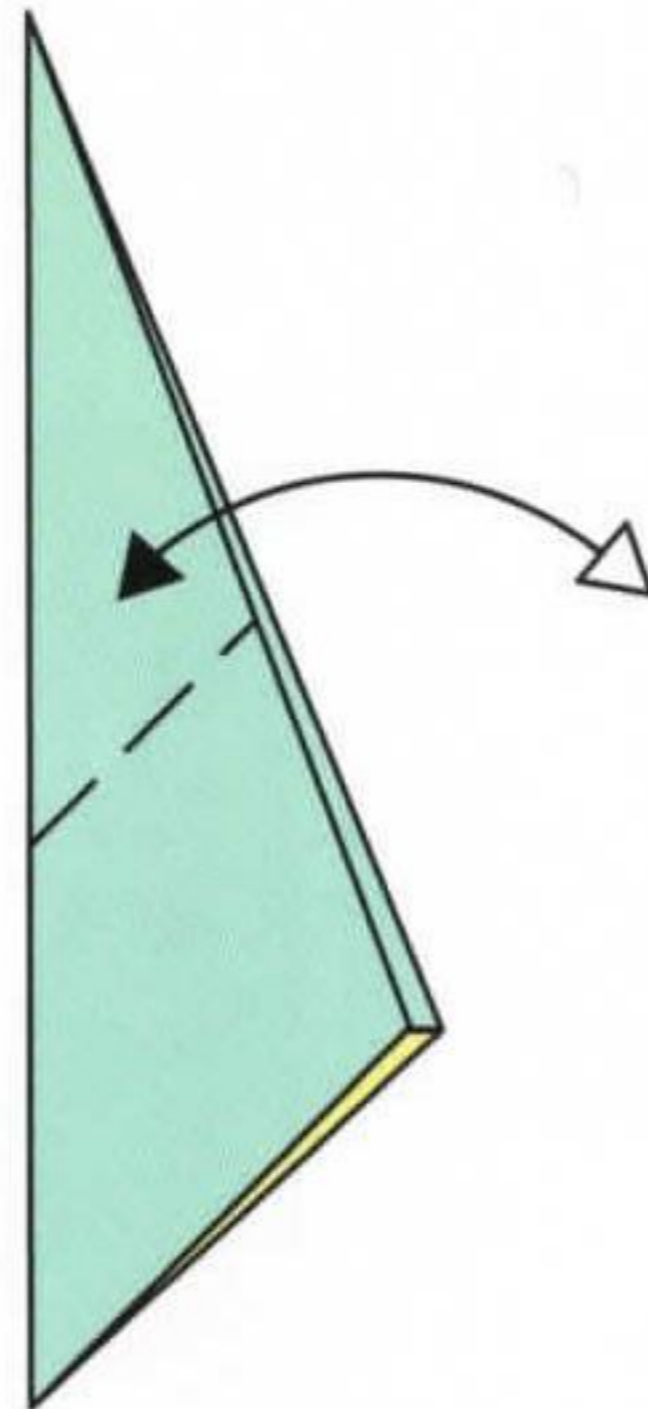

2. Valley fold and unfold

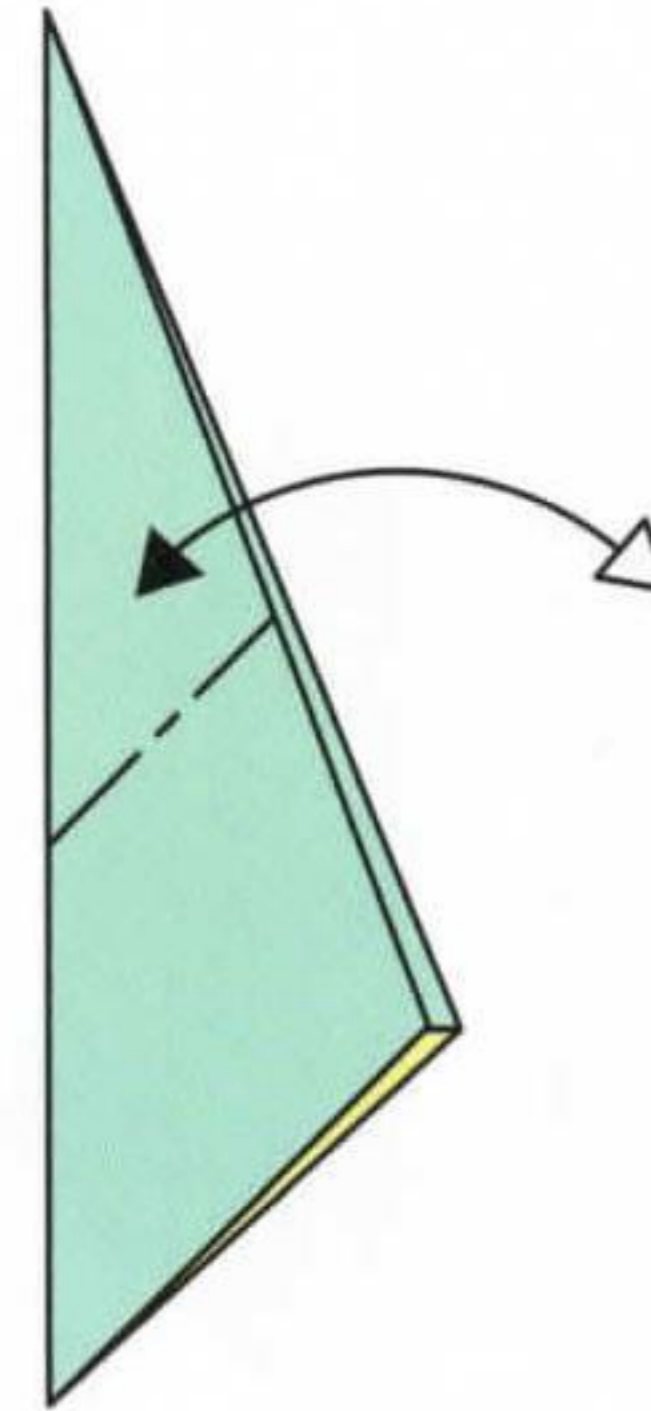

3. Mountain fold and unfold

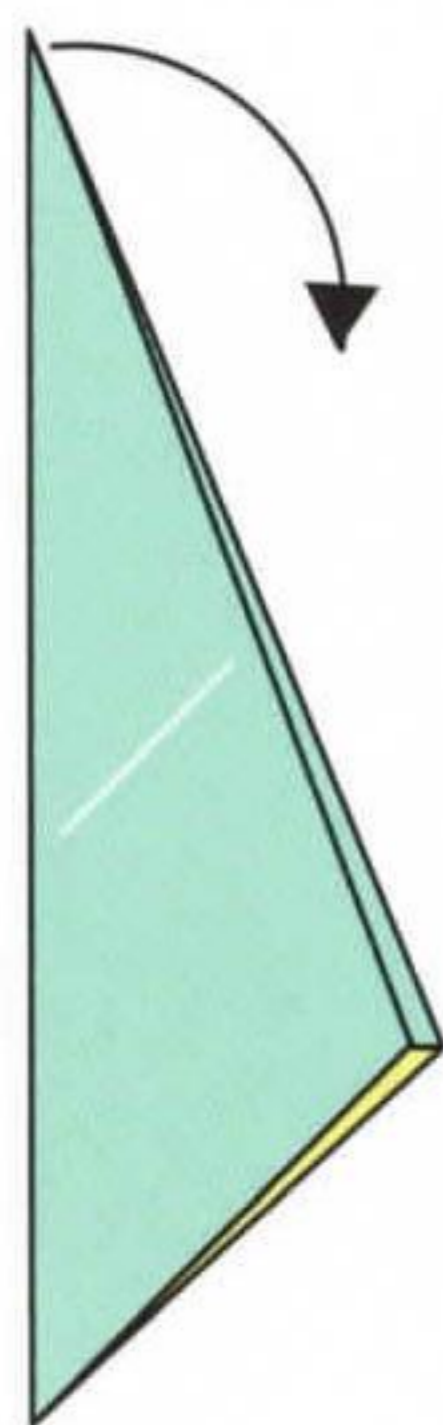

4. Pull and fold

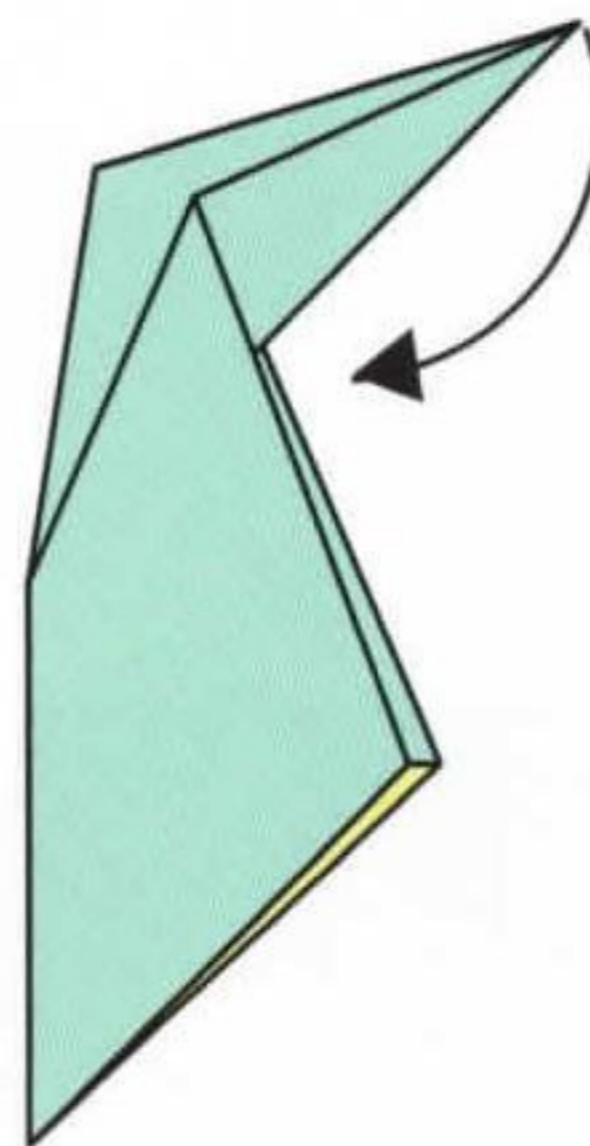

5. Almost complete

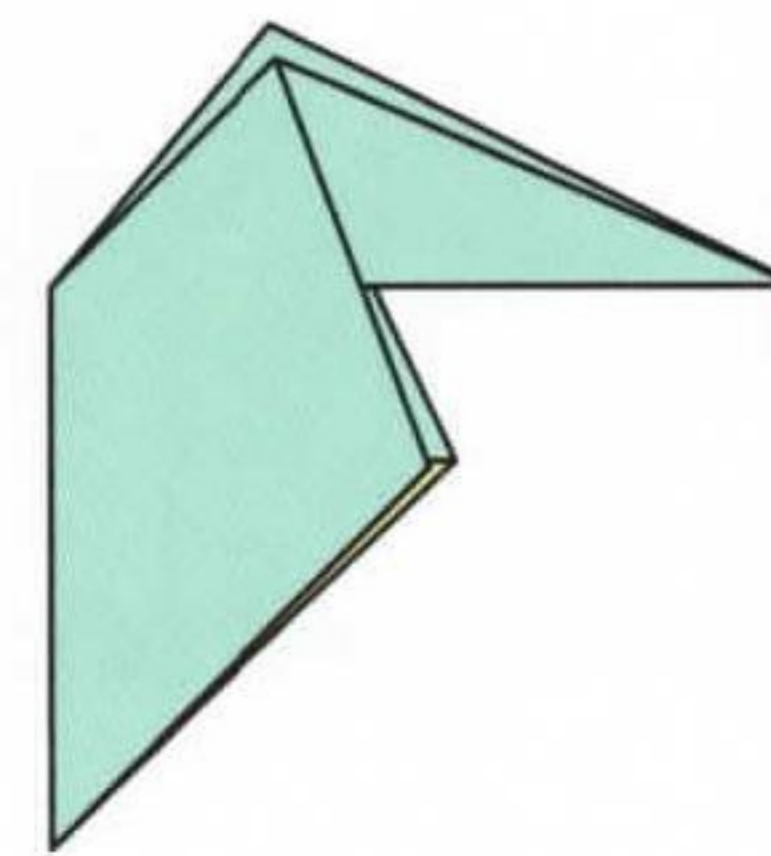

6. Completed
INSIDE REVERSE FOLD

basic folds

OUTSIDE REVERSE FOLD

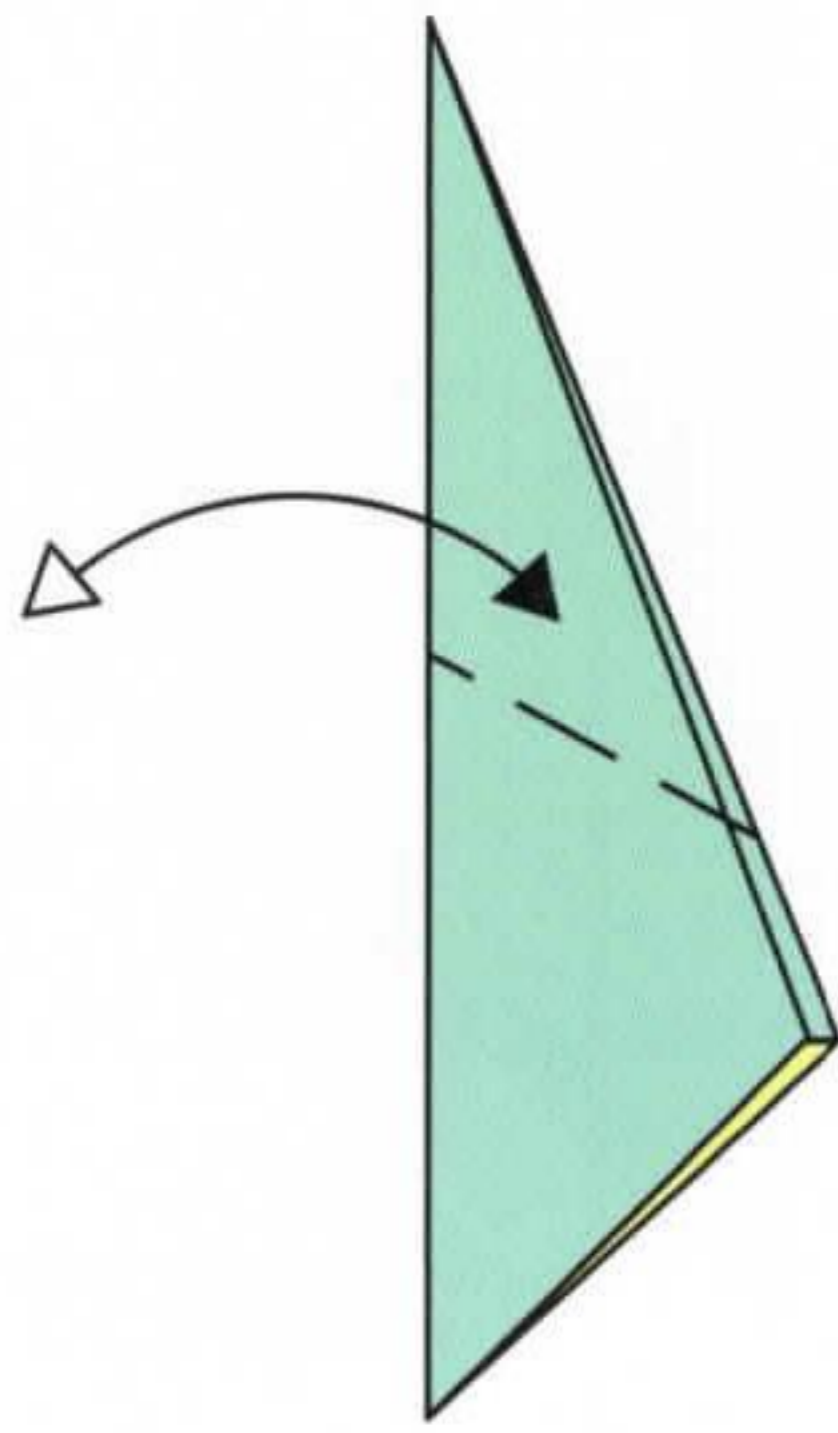

1. Valley fold and unfold

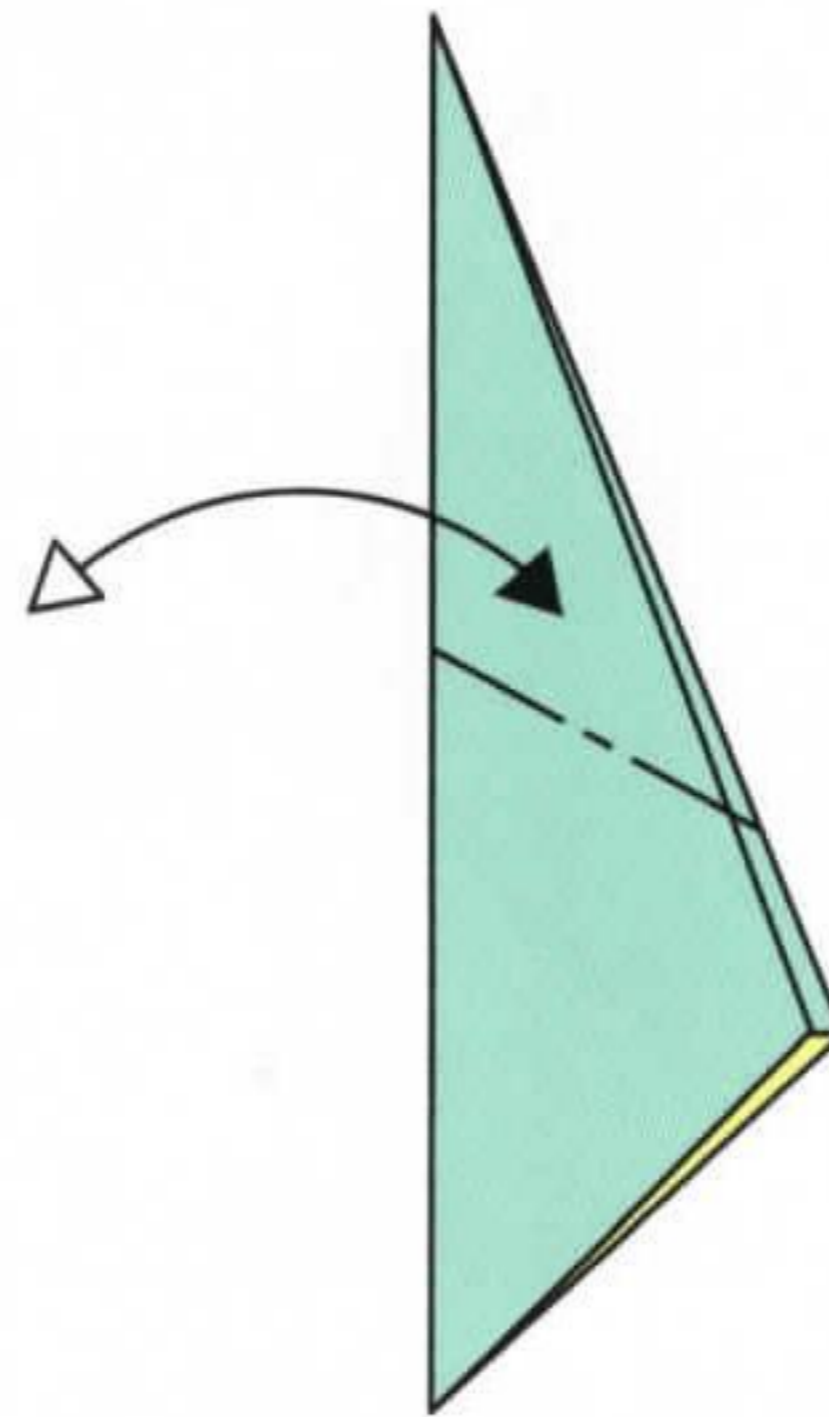

2. Mountain fold and unfold

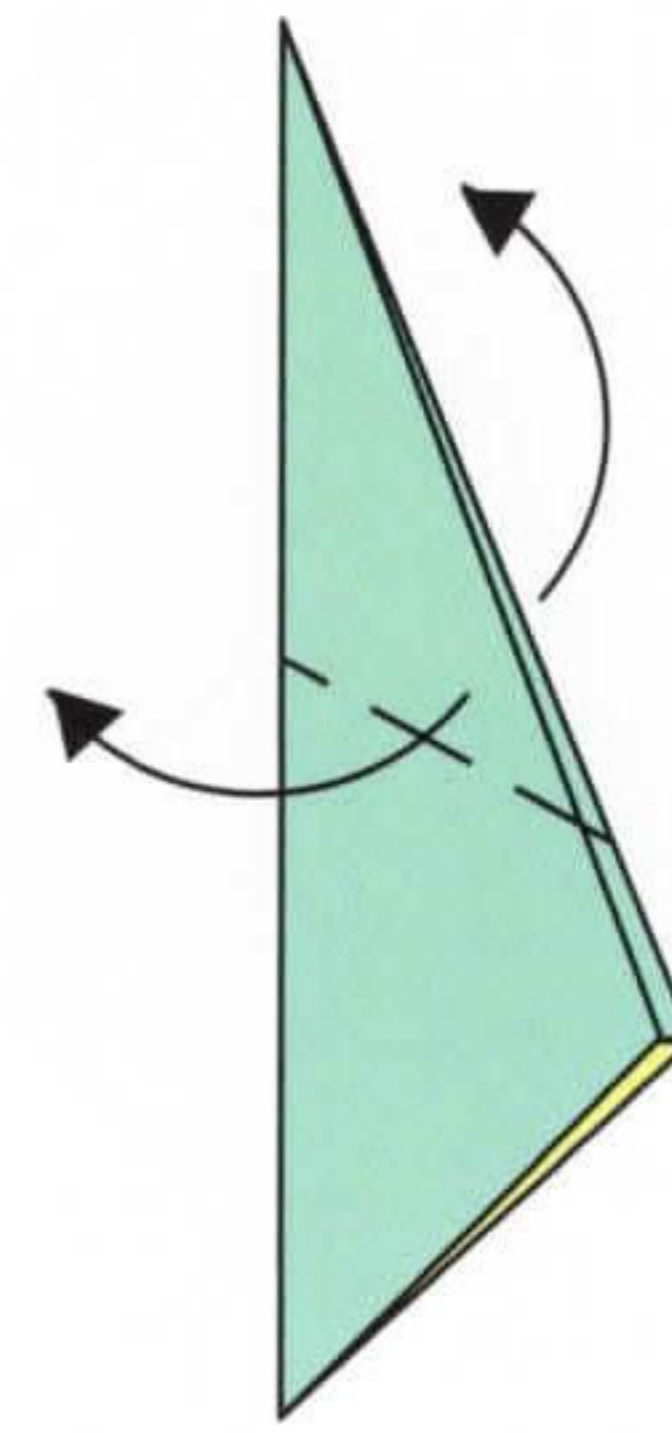

3. Pull and fold

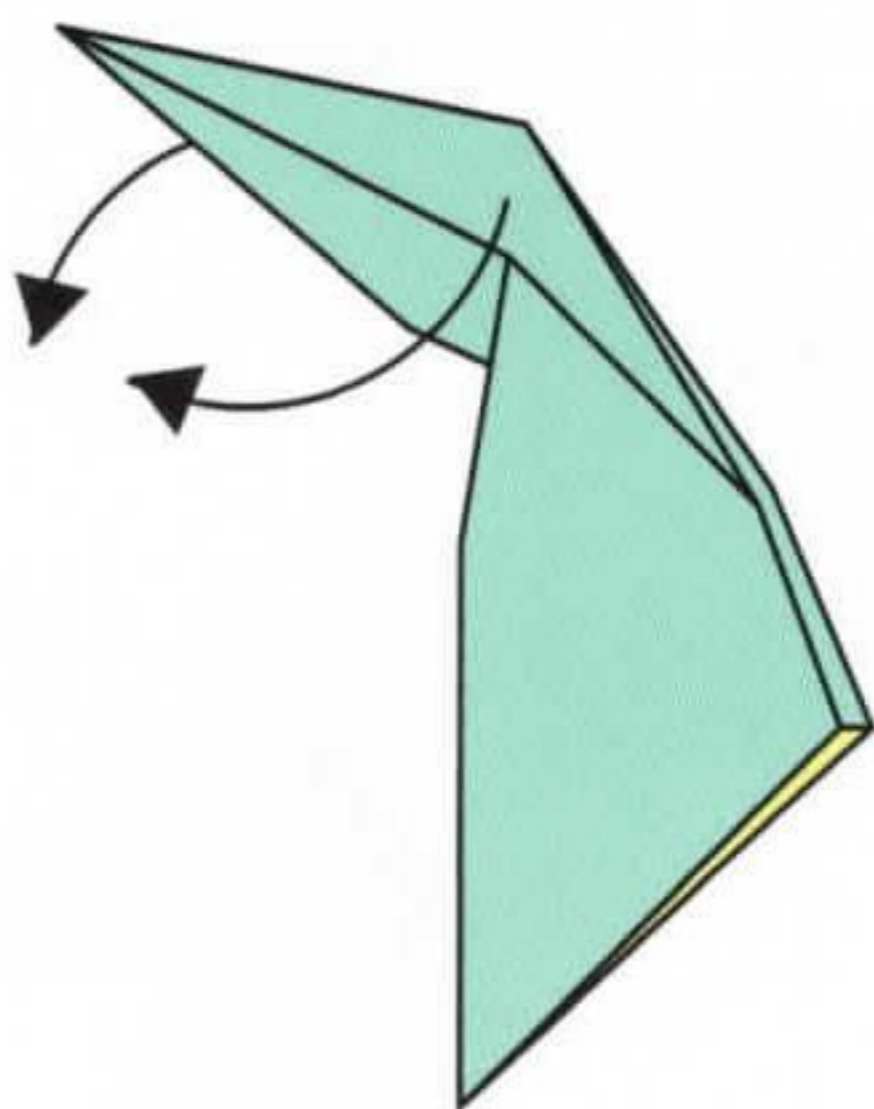

4. Almost complete

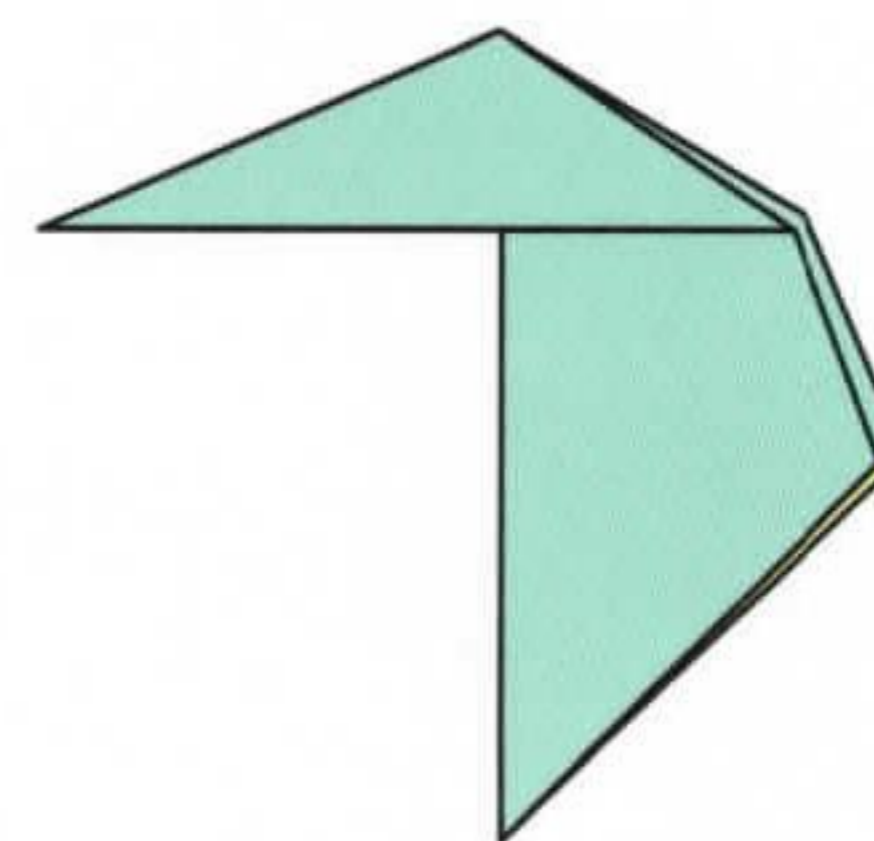

5. Completed
OUTSIDE REVERSE FOLD

PLEAT FOLD

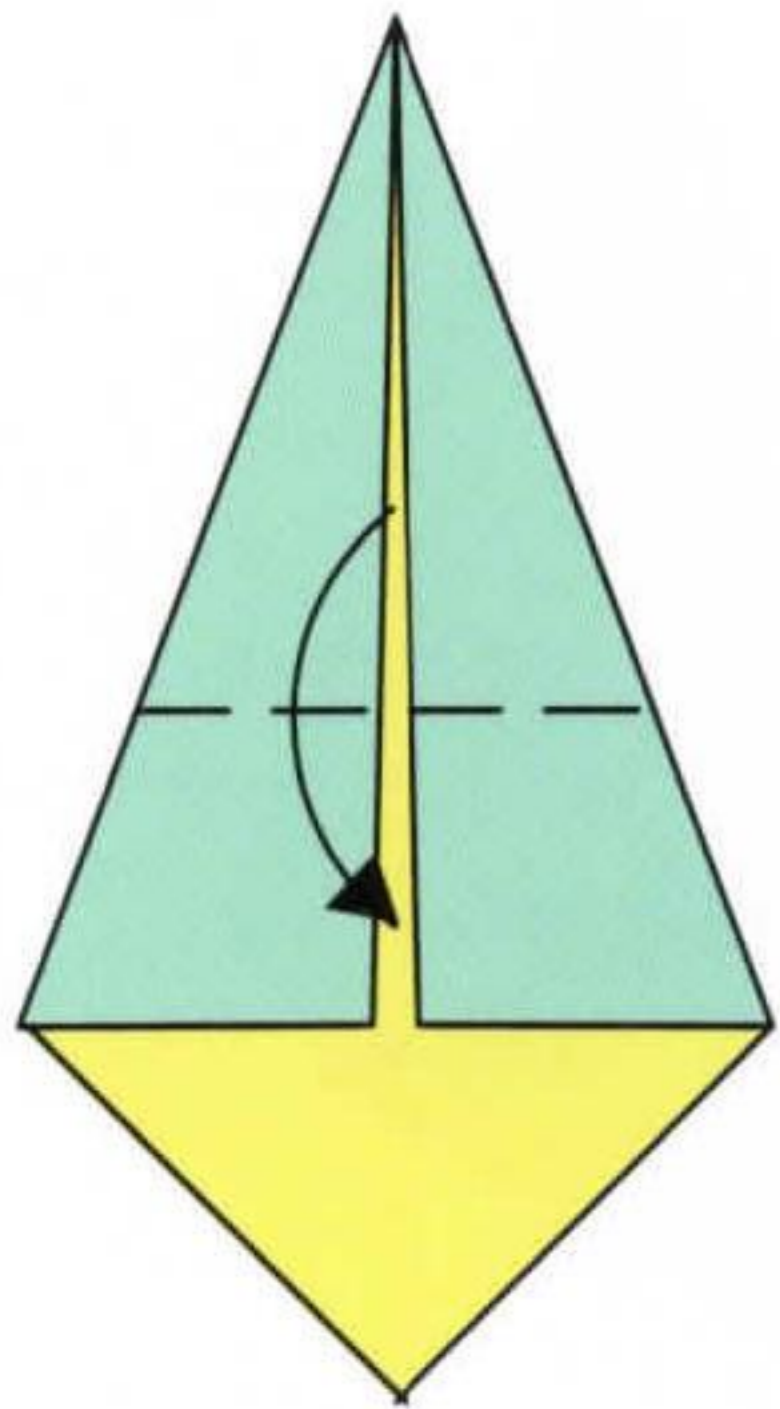

1. Kite fold, then Valley fold

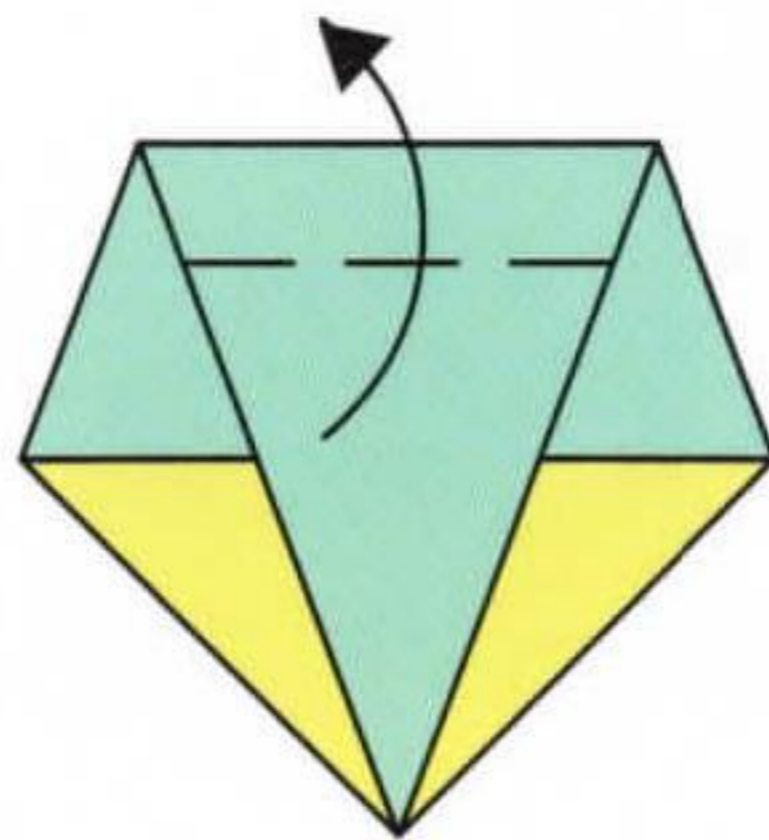

2. Valley fold

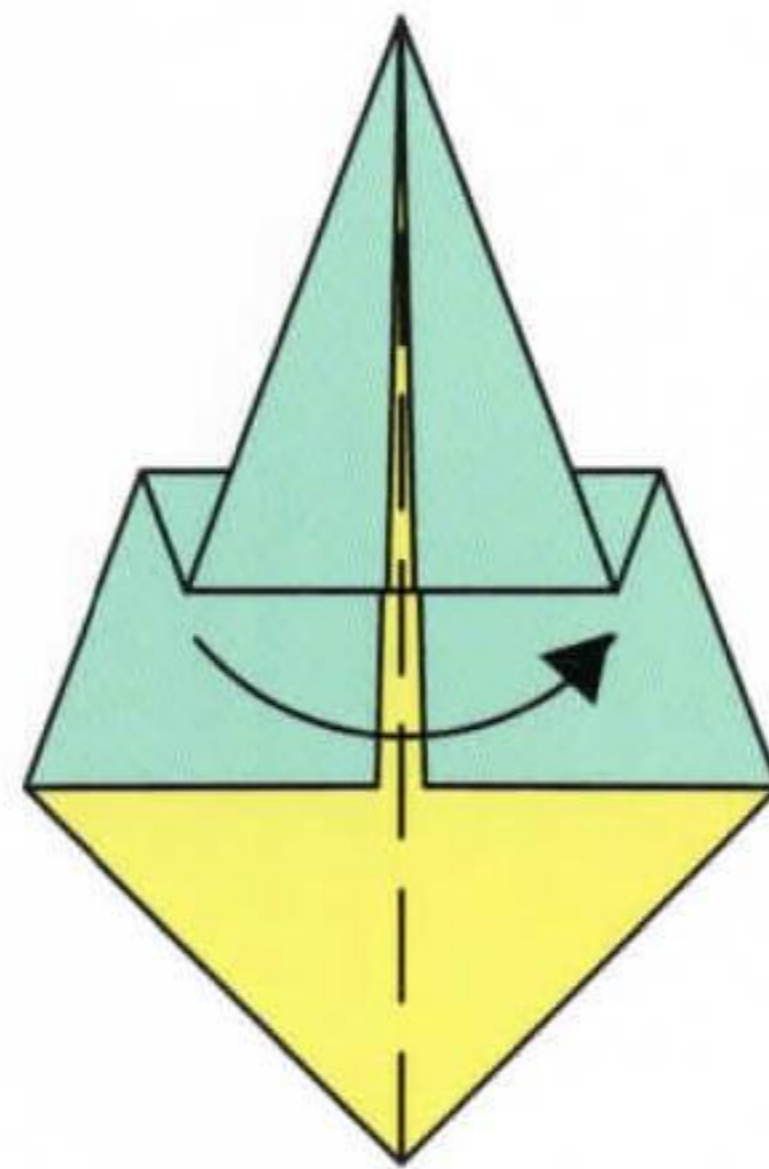

3. Fold in half

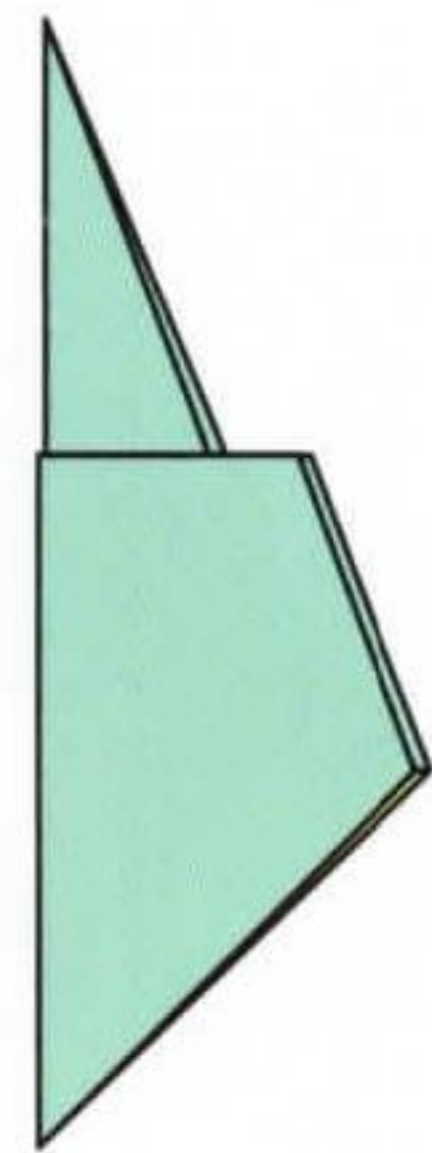

4. Completed PLEAT FOLD

PLEAT FOLD REVERSE

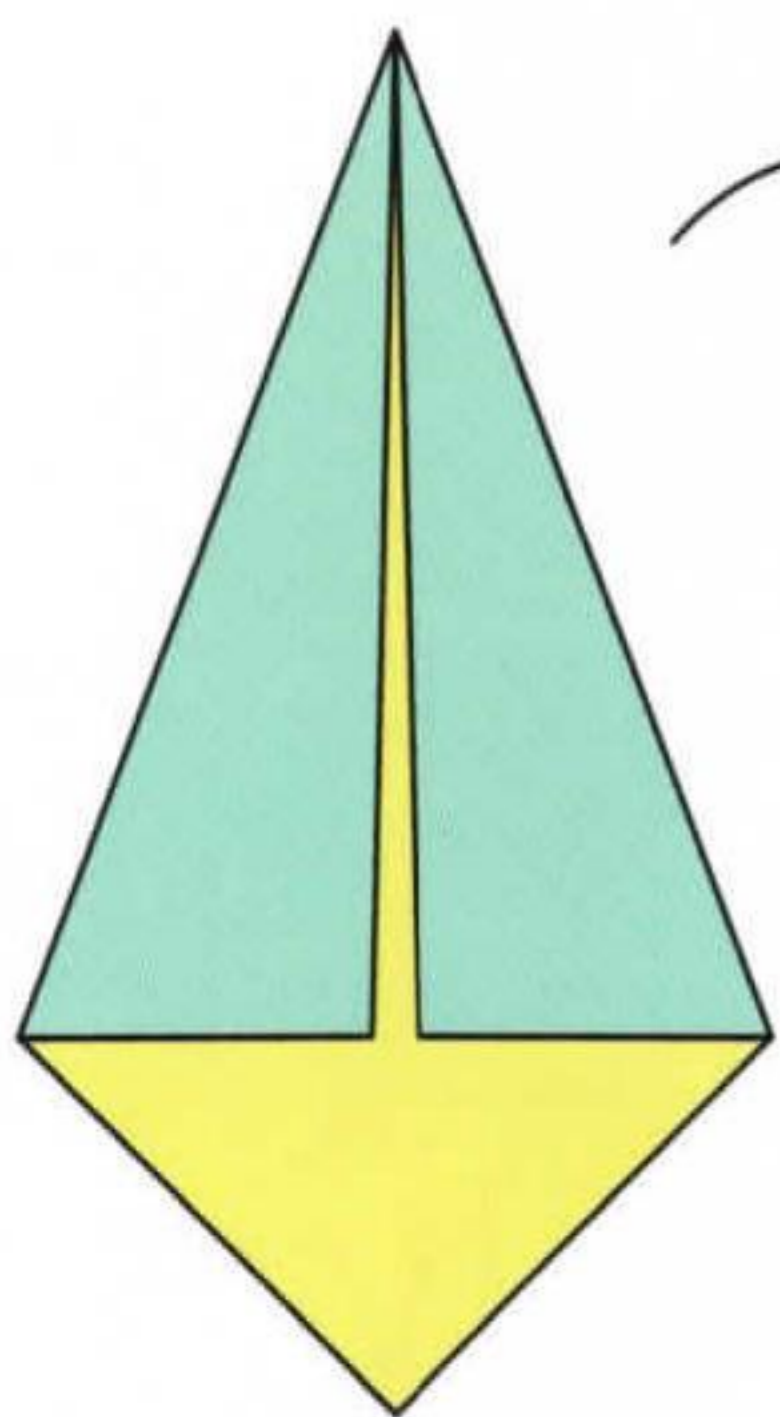

Kite fold, then turn over

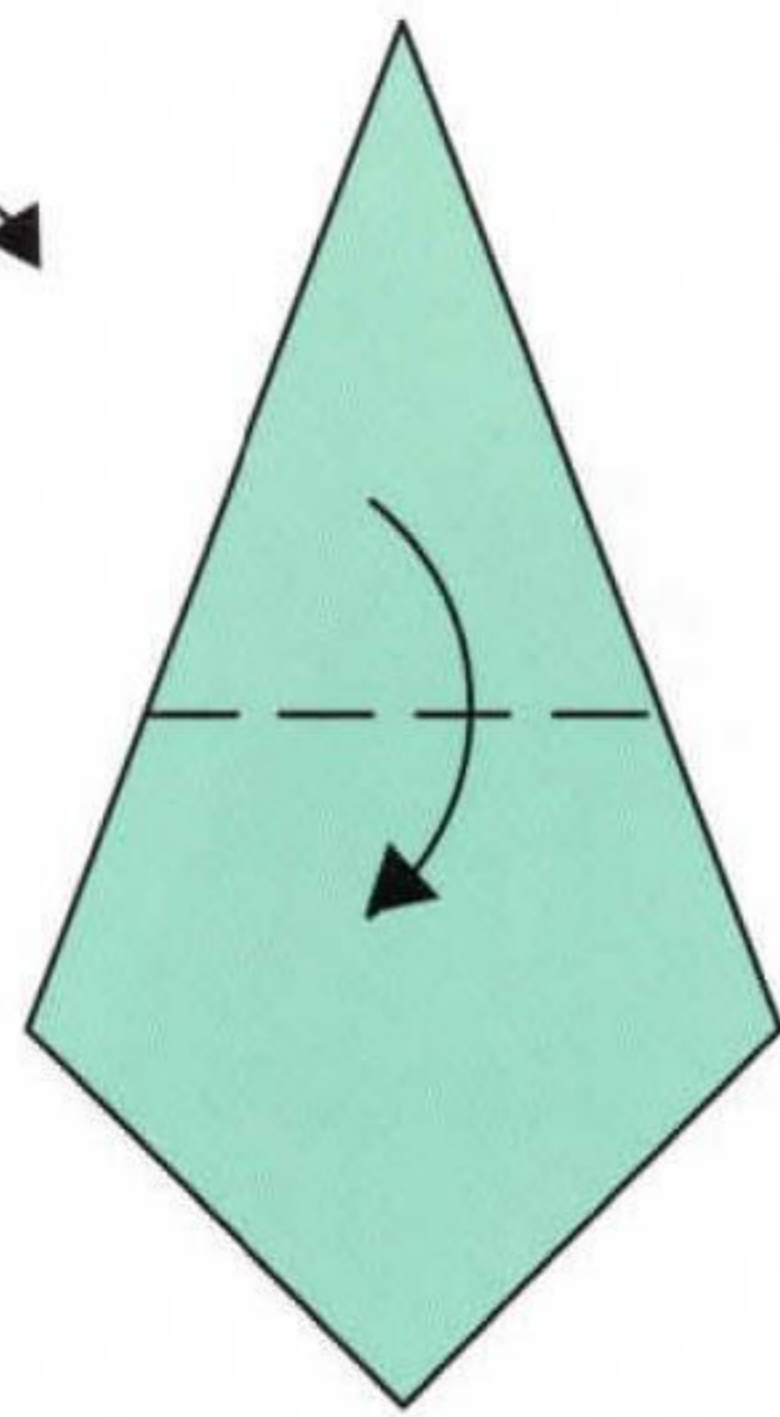

2. Valley fold

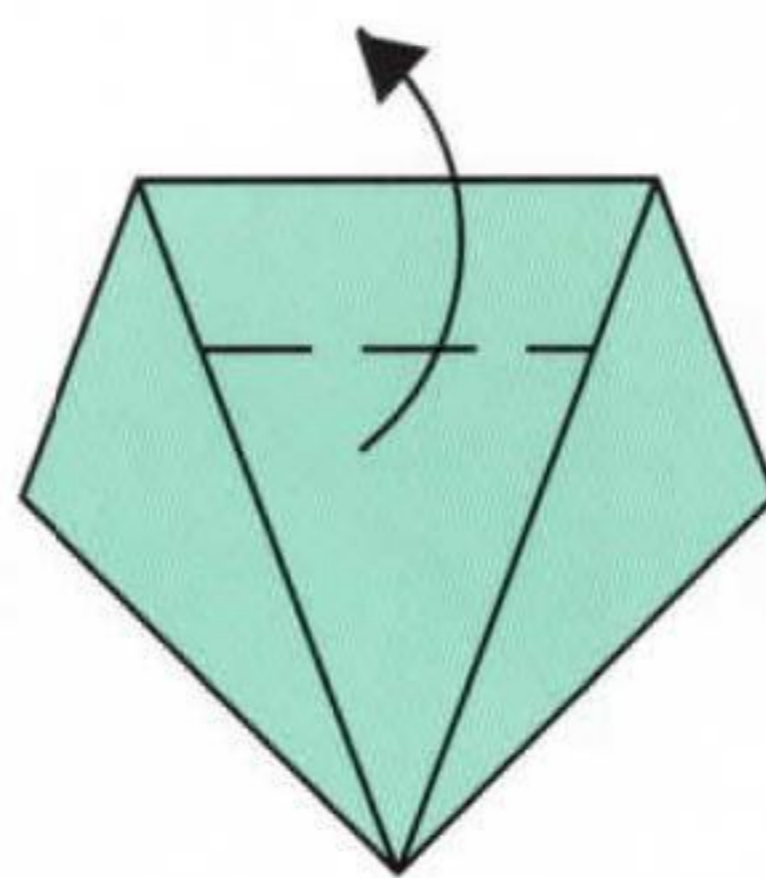

3. Valley fold

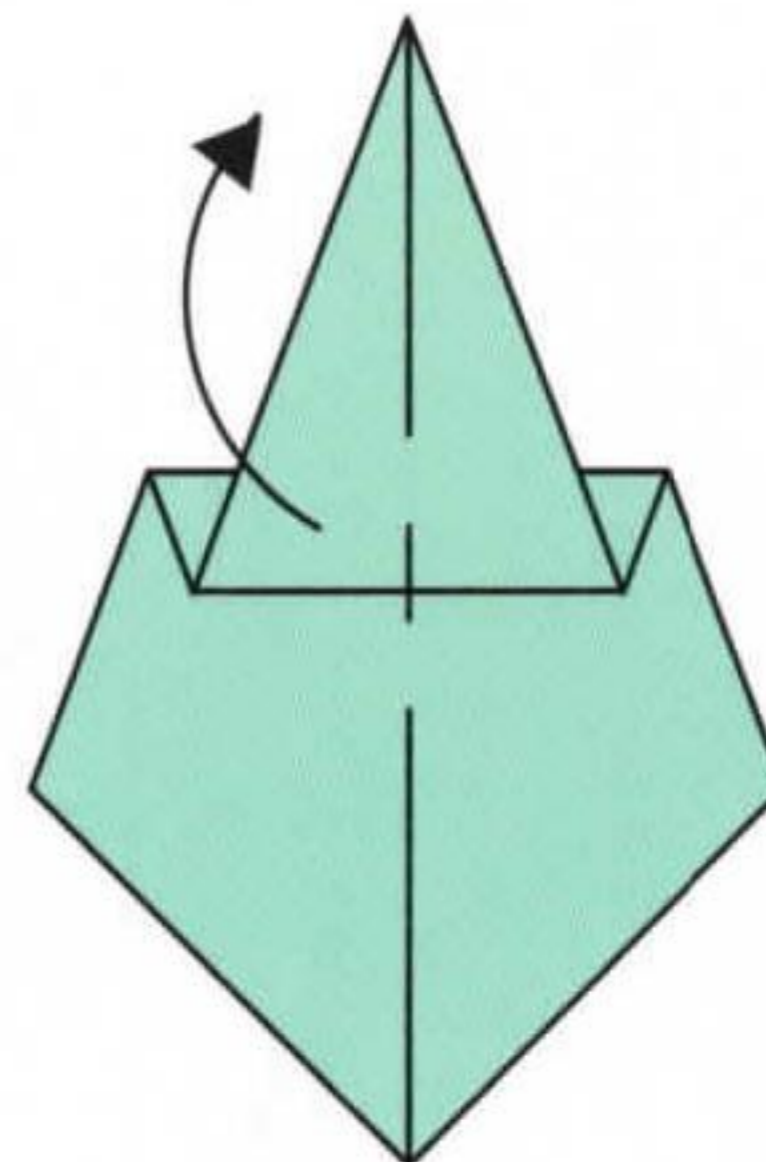

4. Mountain fold

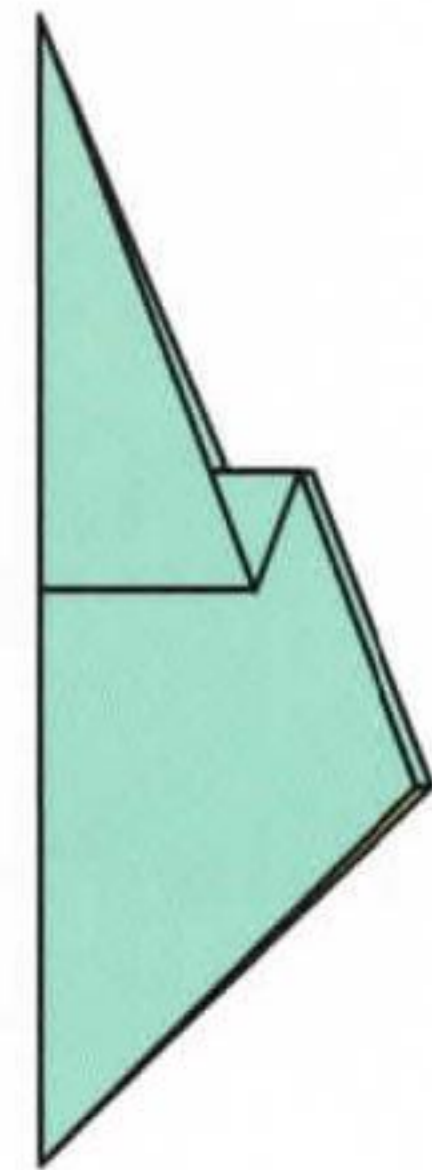

5. Completed PLEAT FOLD REVERSE

basic folds

SQUASH FOLD 1

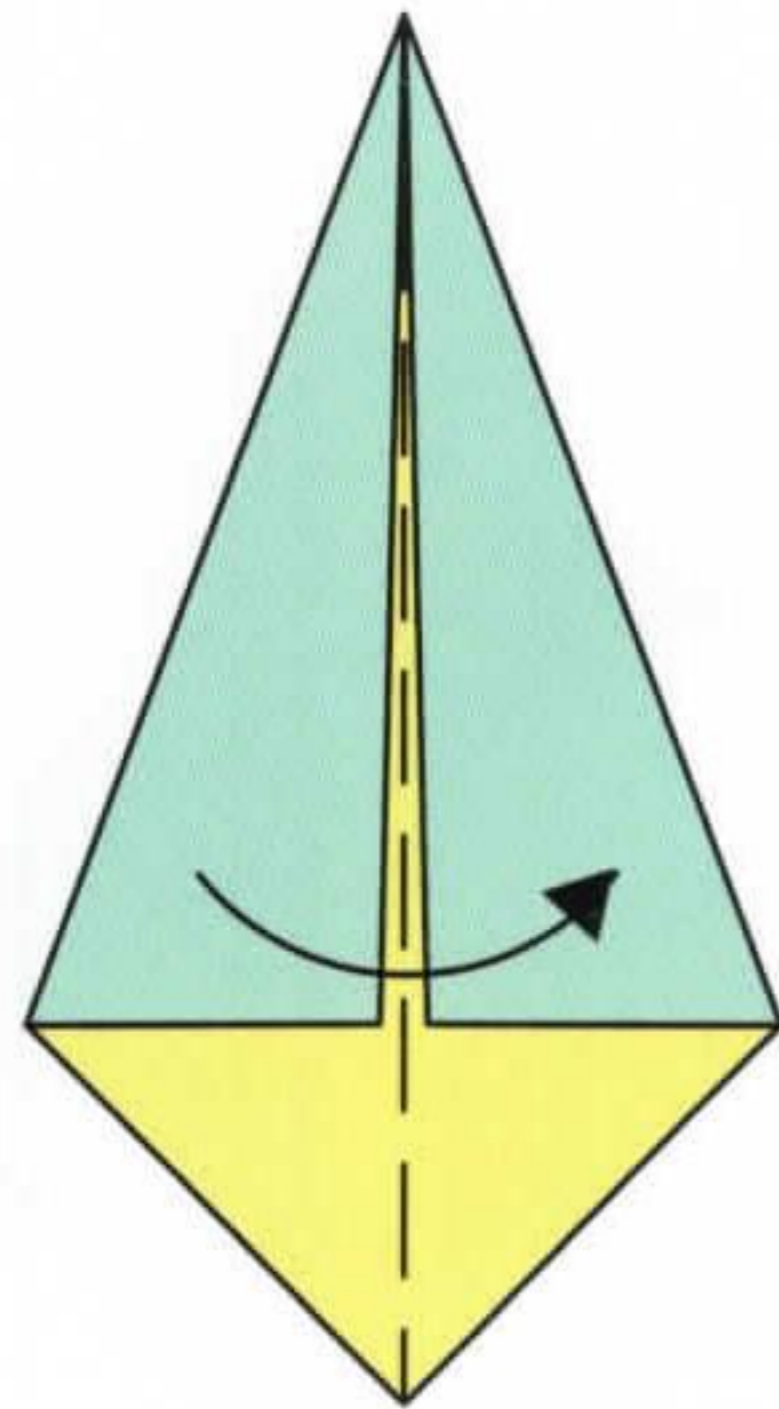

1. Kite fold, then turn over

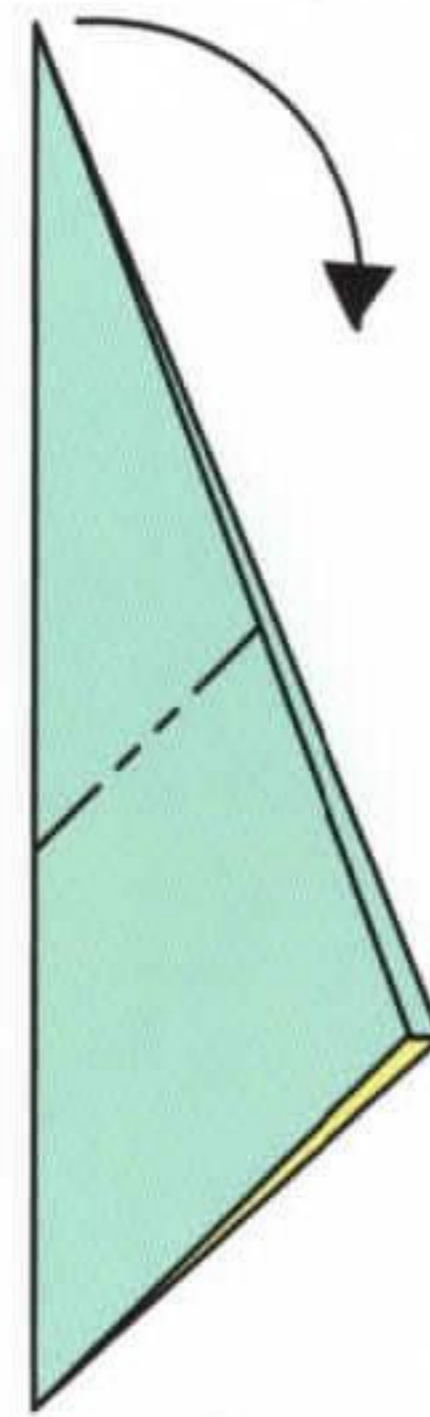

2. Inside Reverse fold

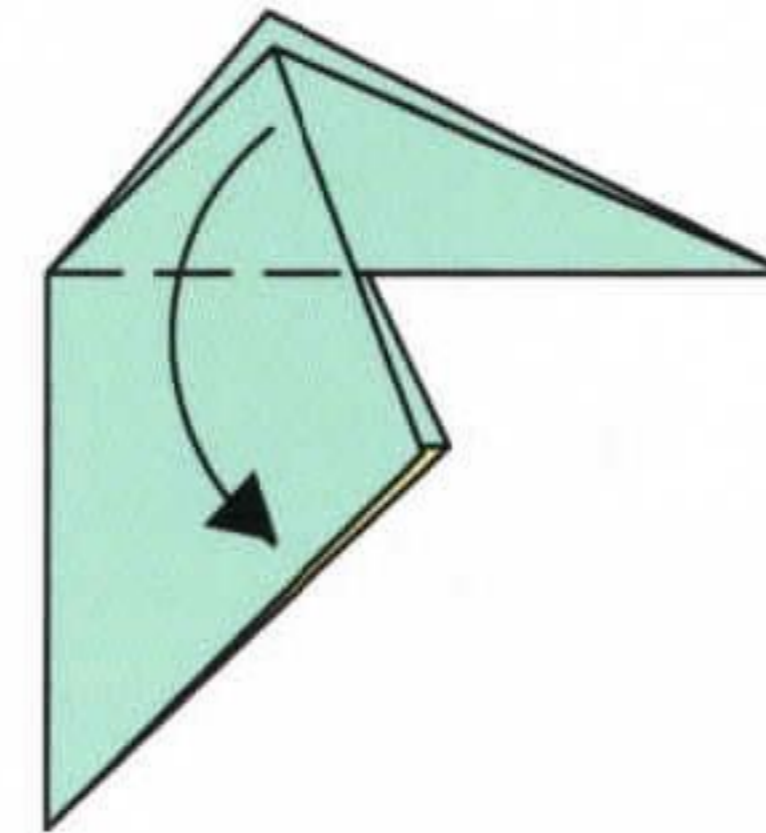

3. Valley fold

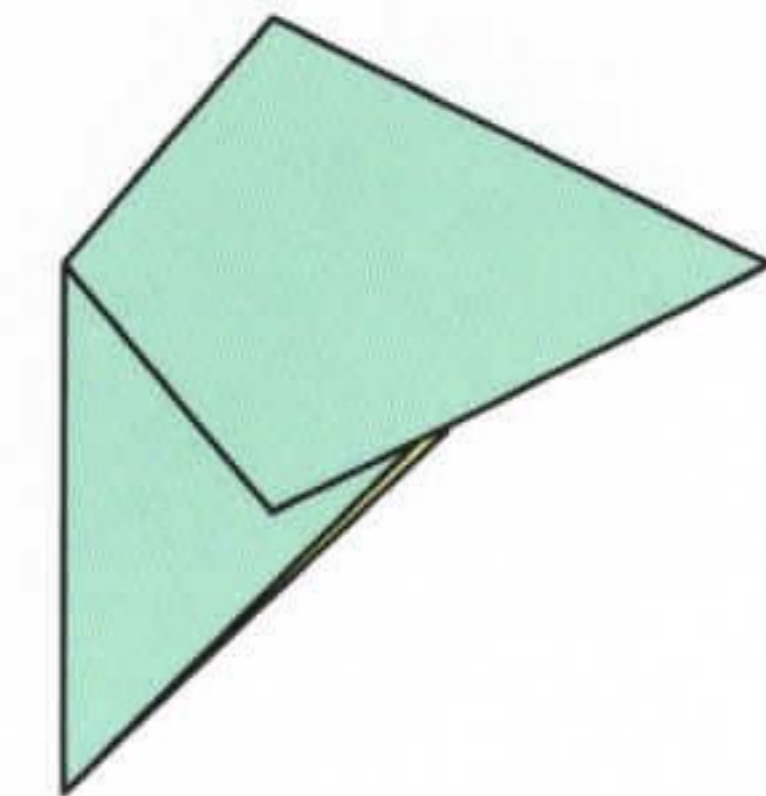

4. Completed SQUASH FOLD 1

SQUASH FOLD 2

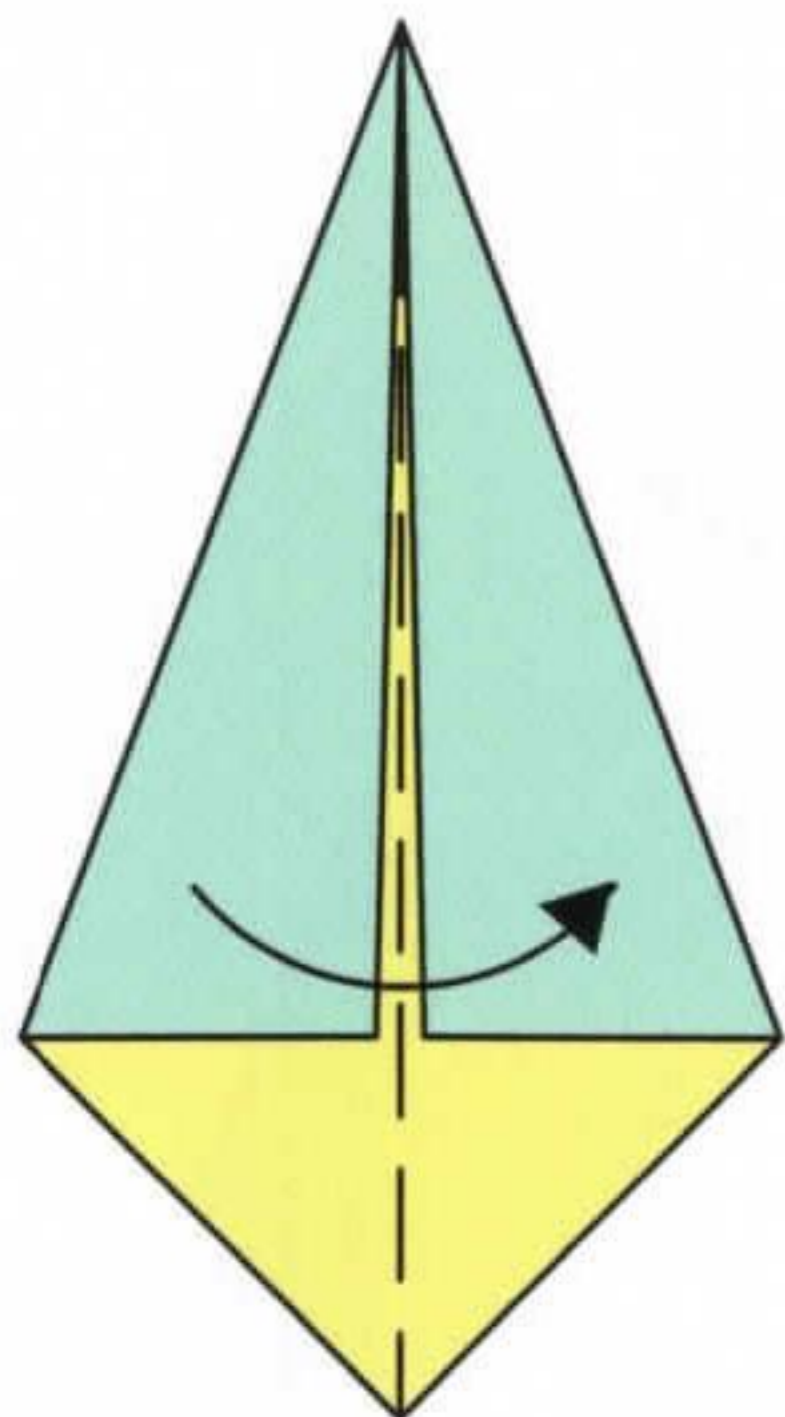

1. Kite fold, then Valley fold

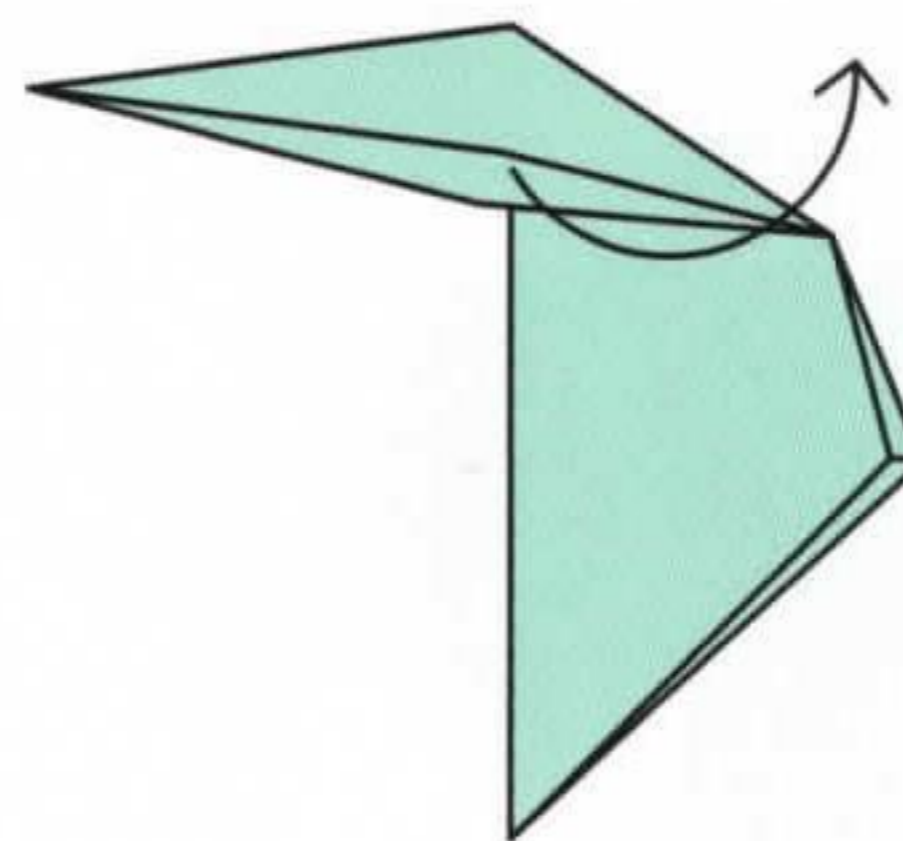

3. Pull and fold

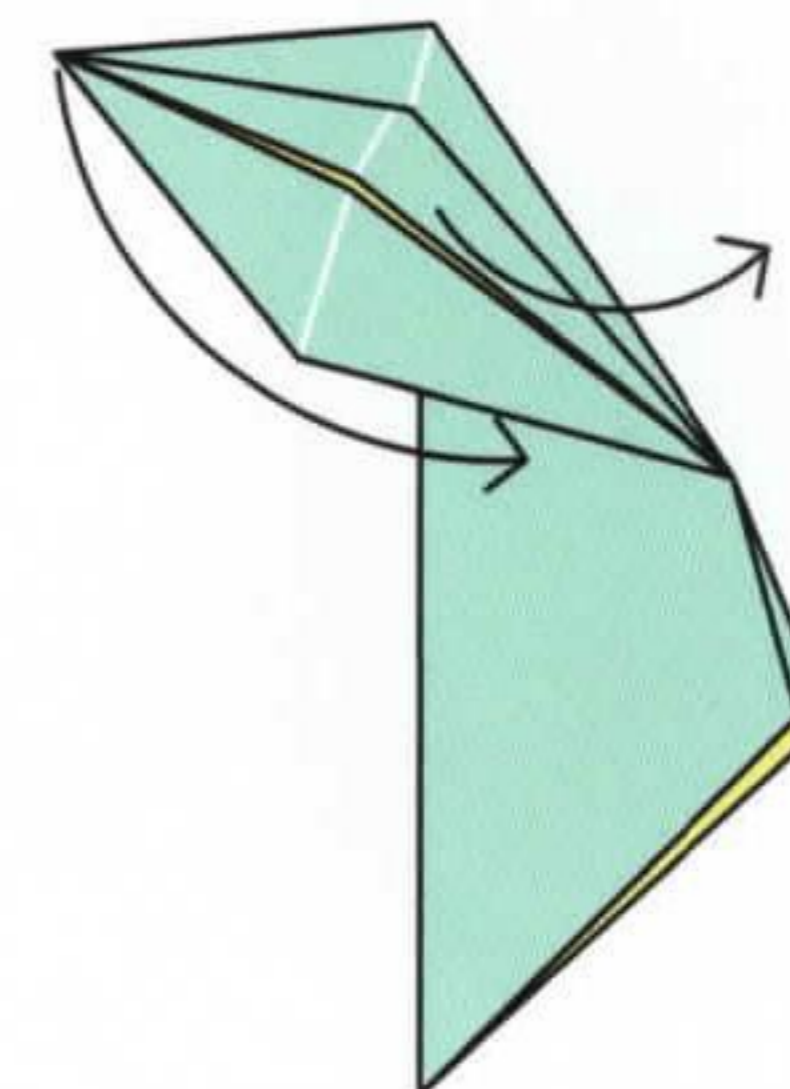

4. Almost complete

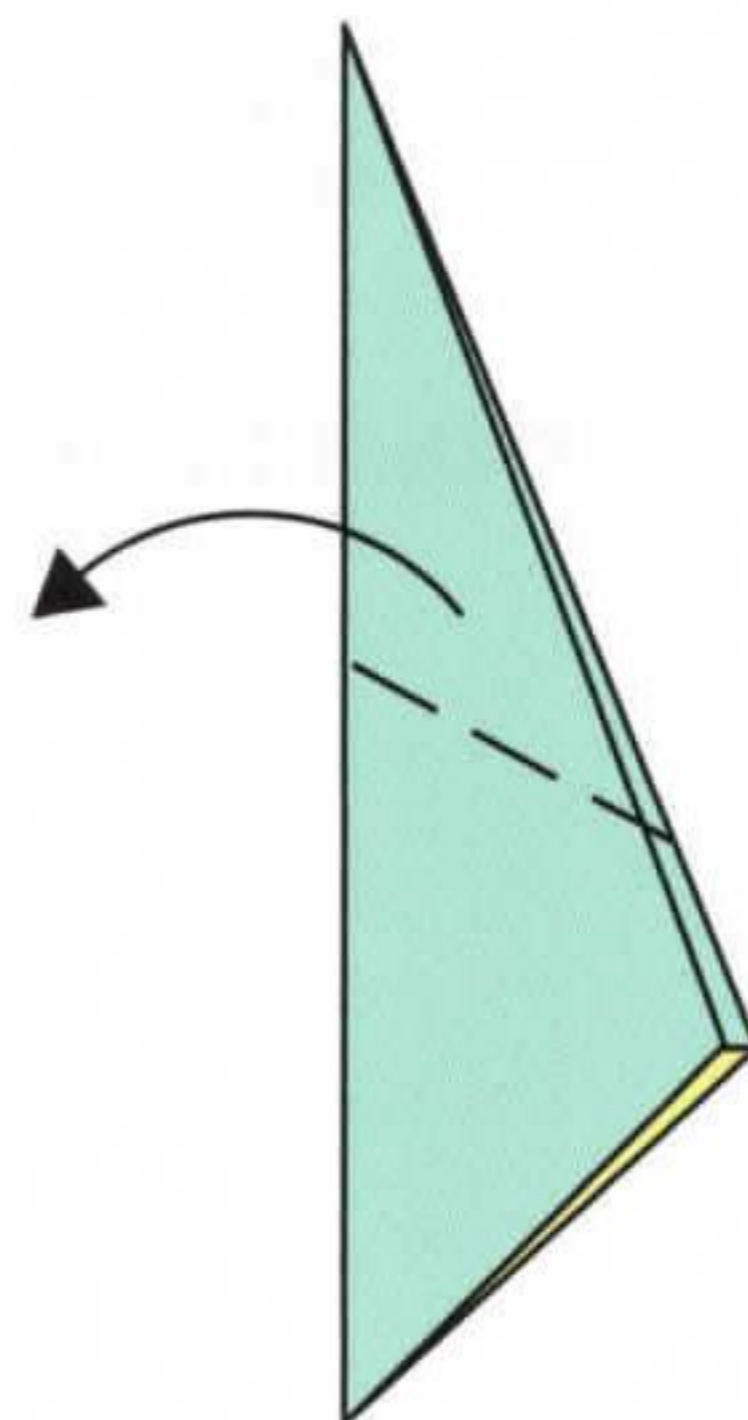

2. Valley fold

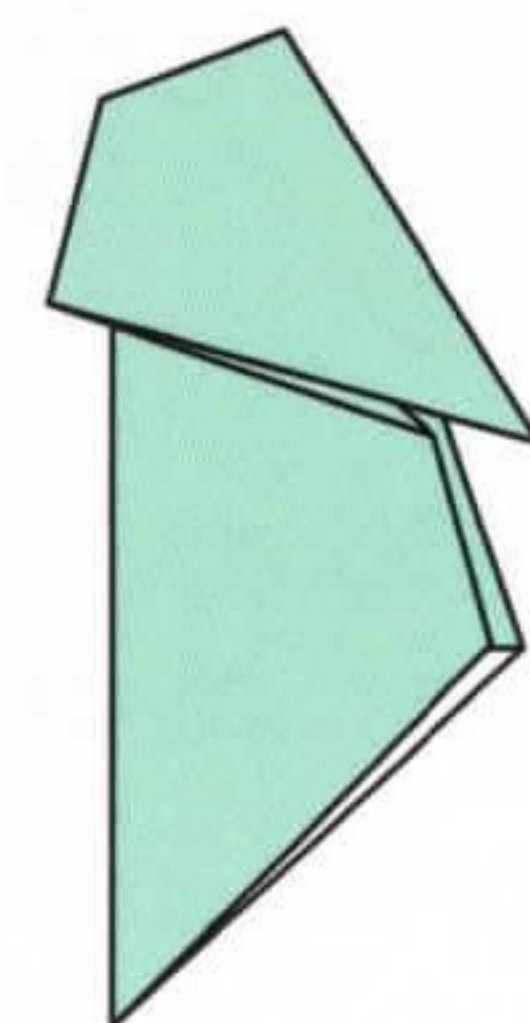

5. Completed SQUASH FOLD 2

basic folds

SINK FOLD

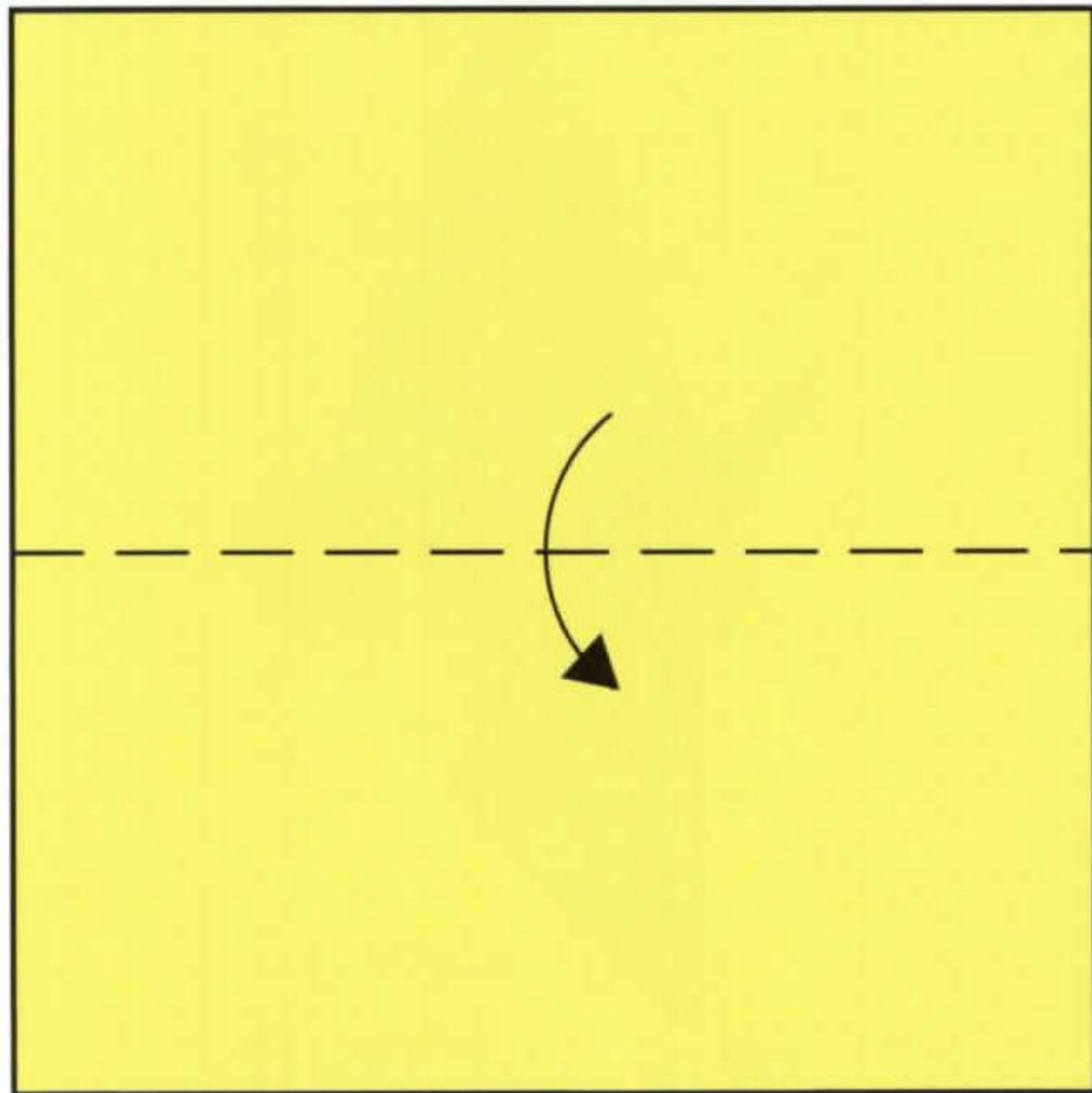

1. Valley fold

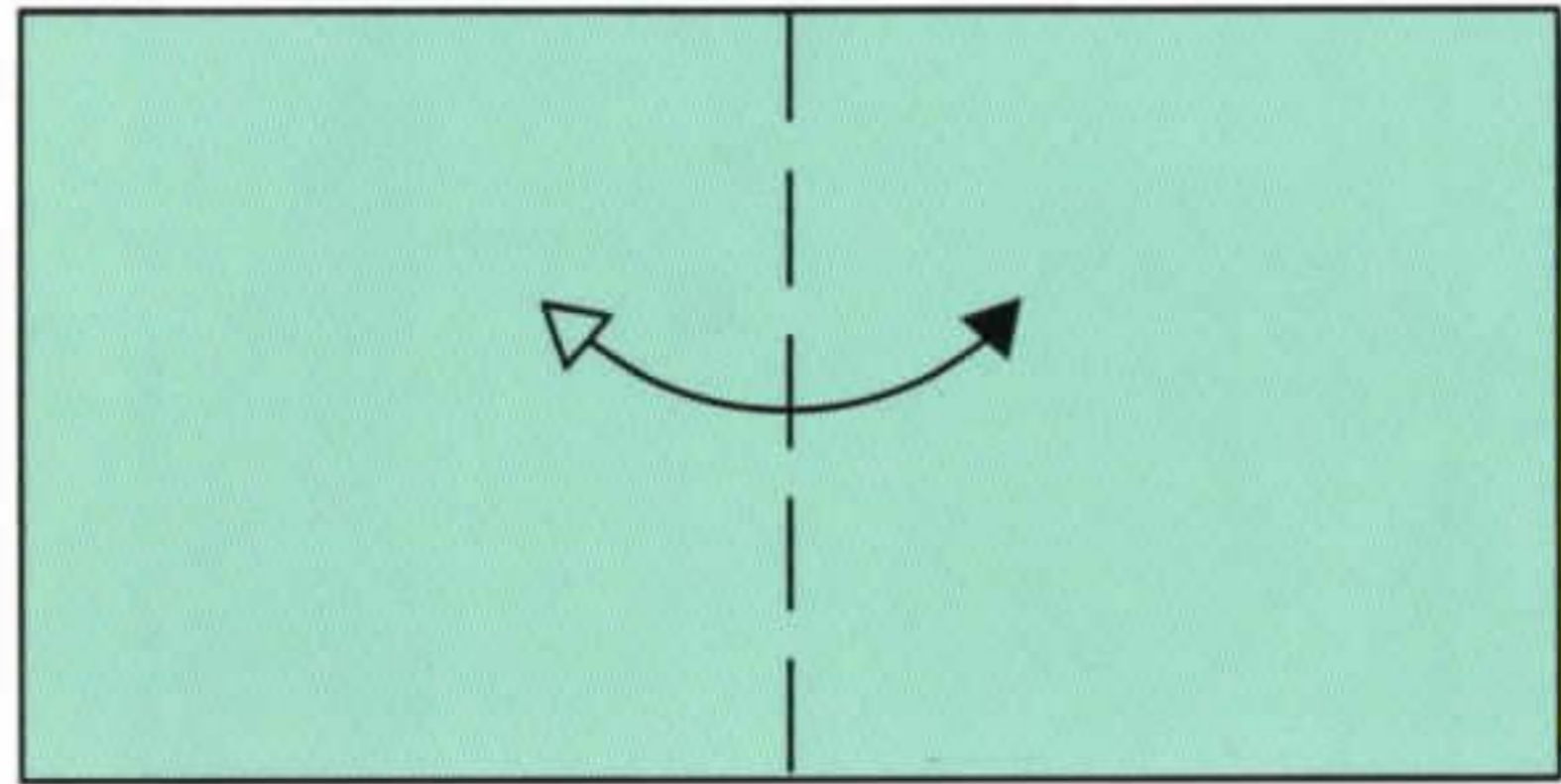

2. Valley fold and unfold

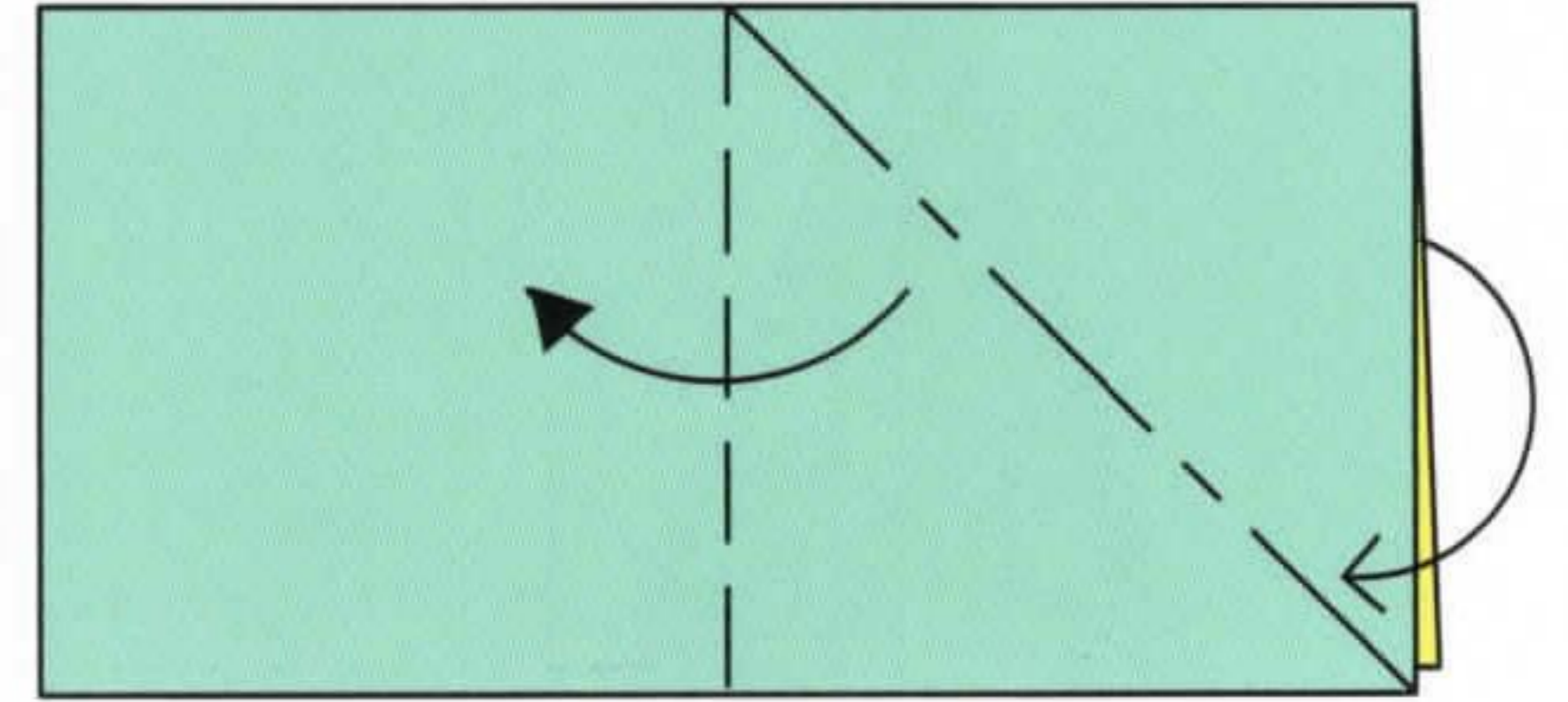

3. Squash fold

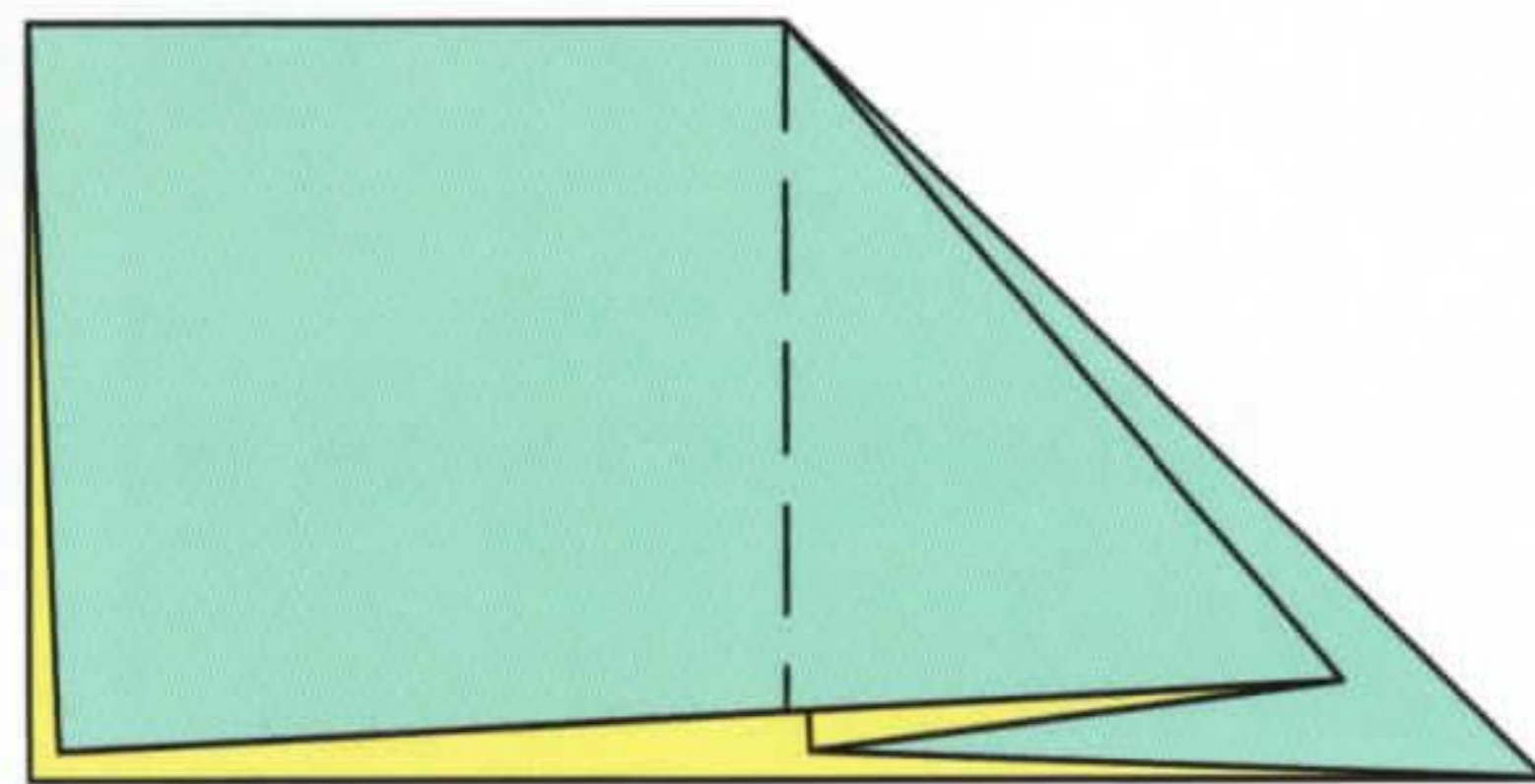

4. Before complete

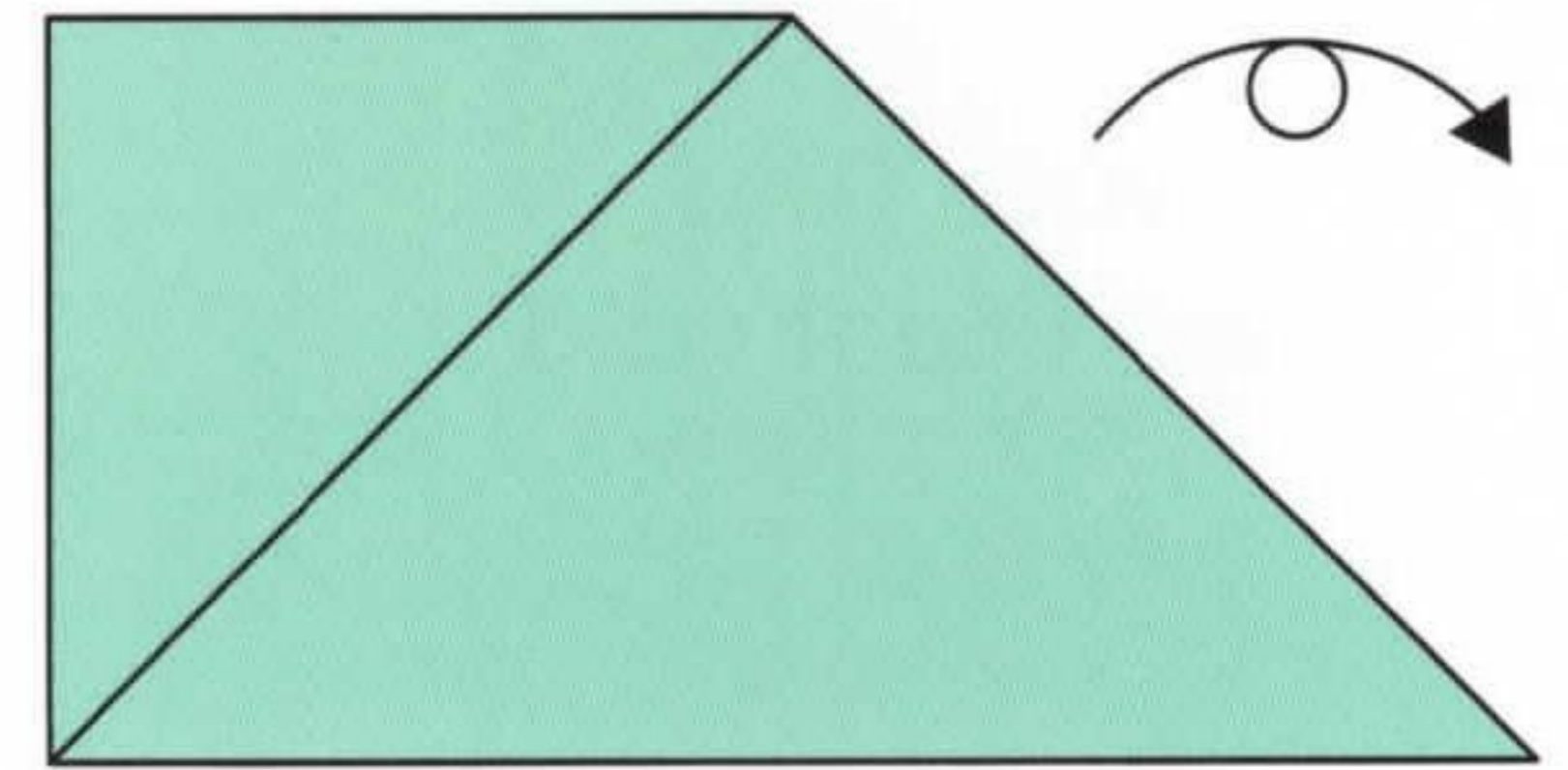

5. Turn over

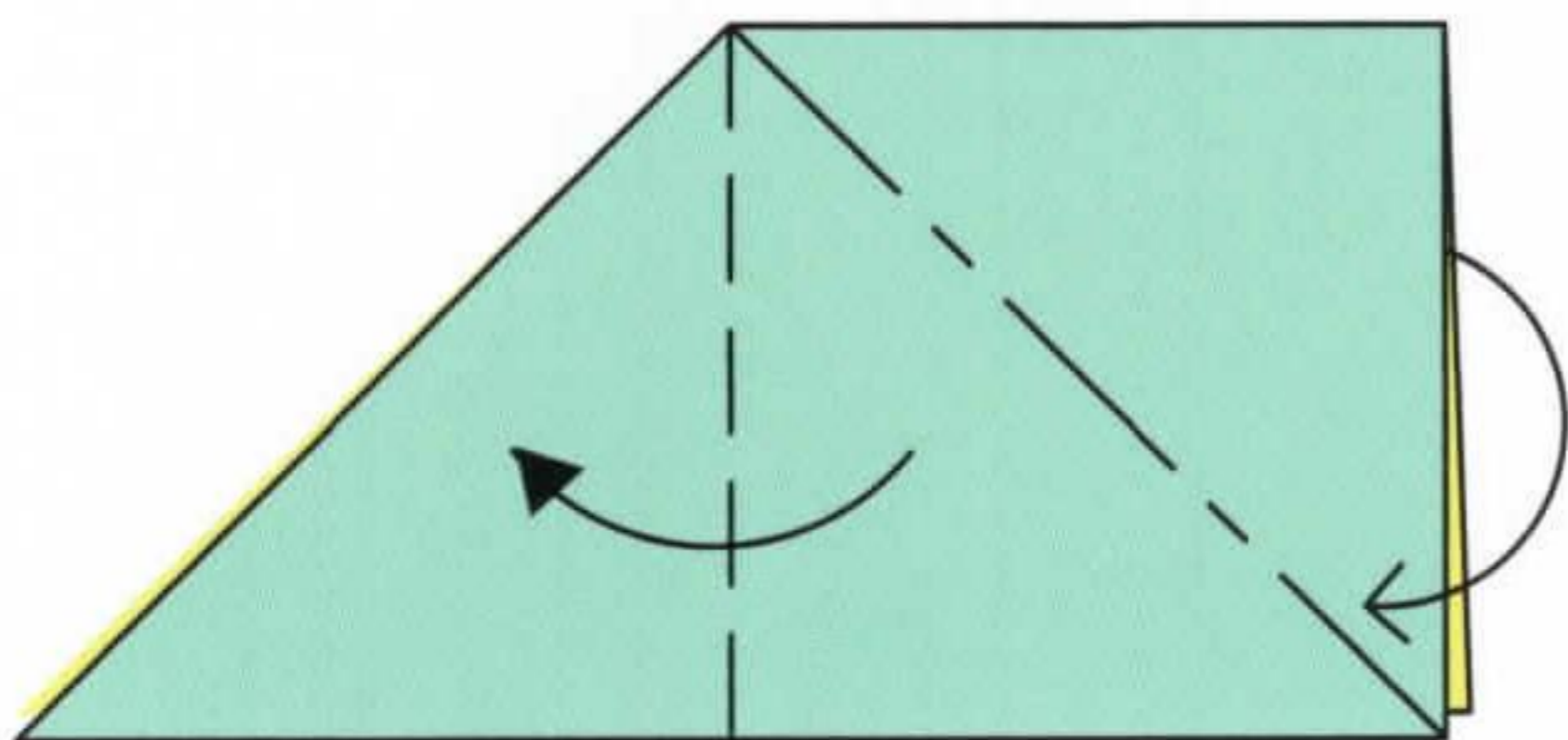

6. Squash fold

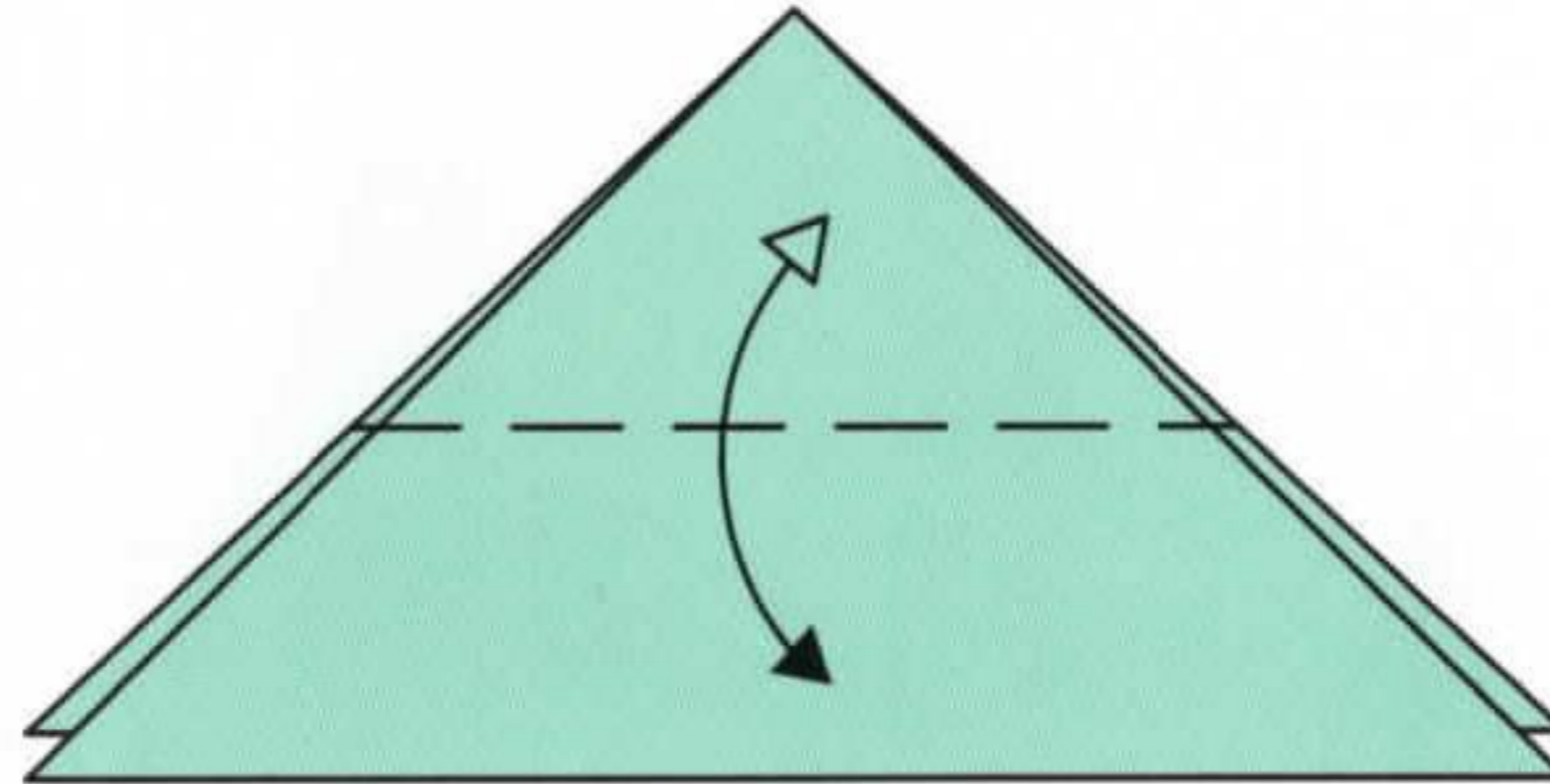

7. Front fold and unfold

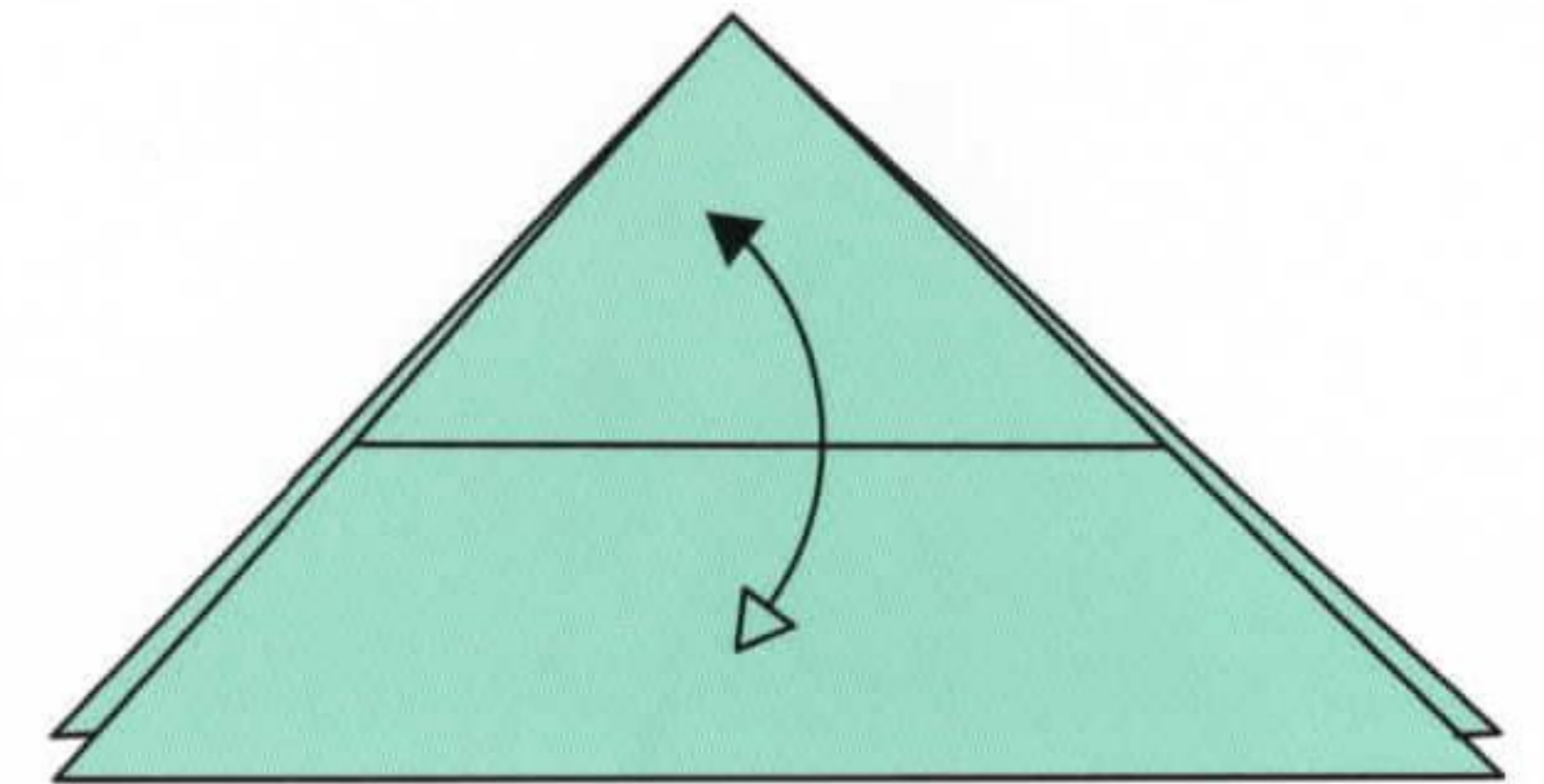

8. Mountain fold and unfold

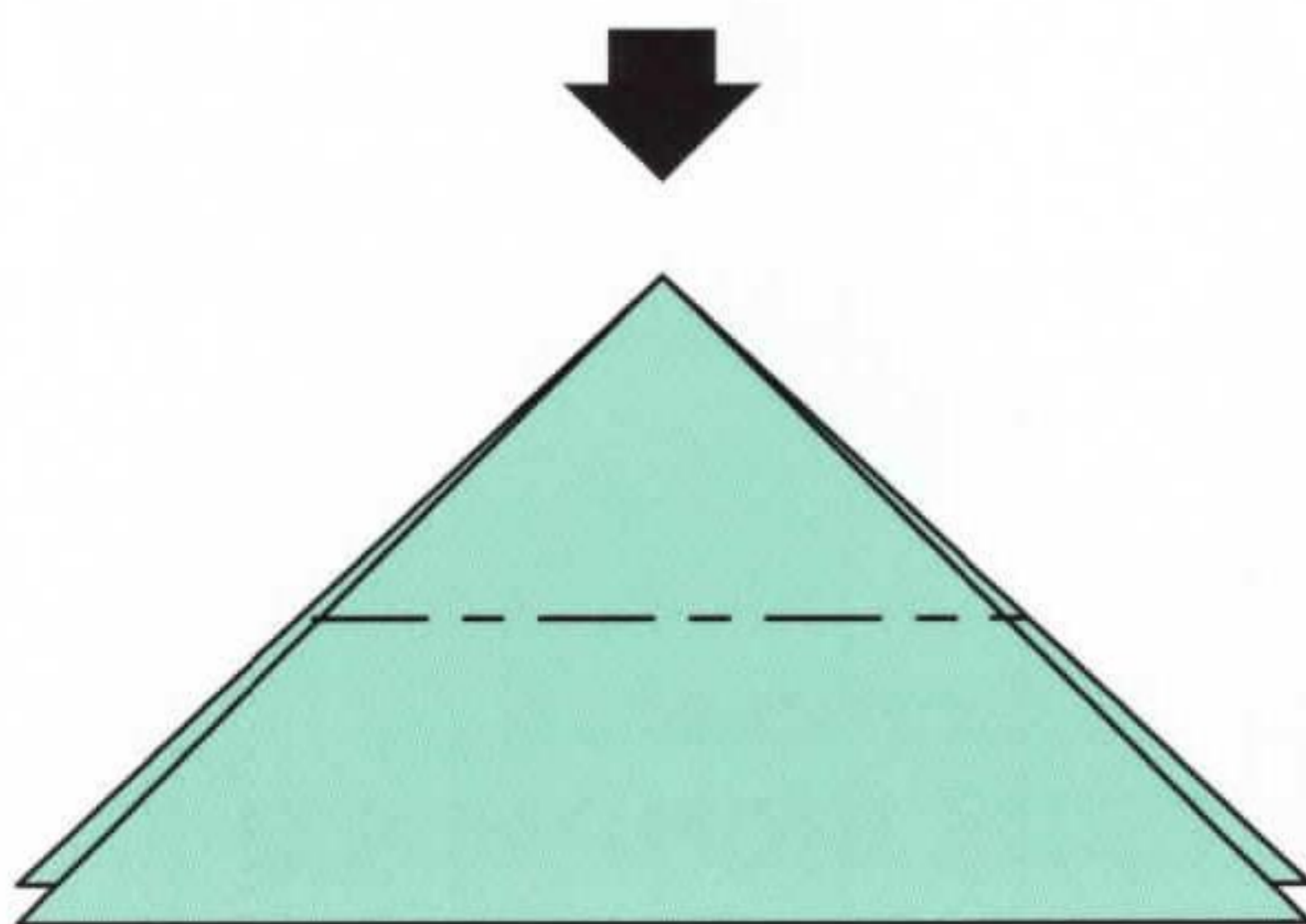

9. Push inward

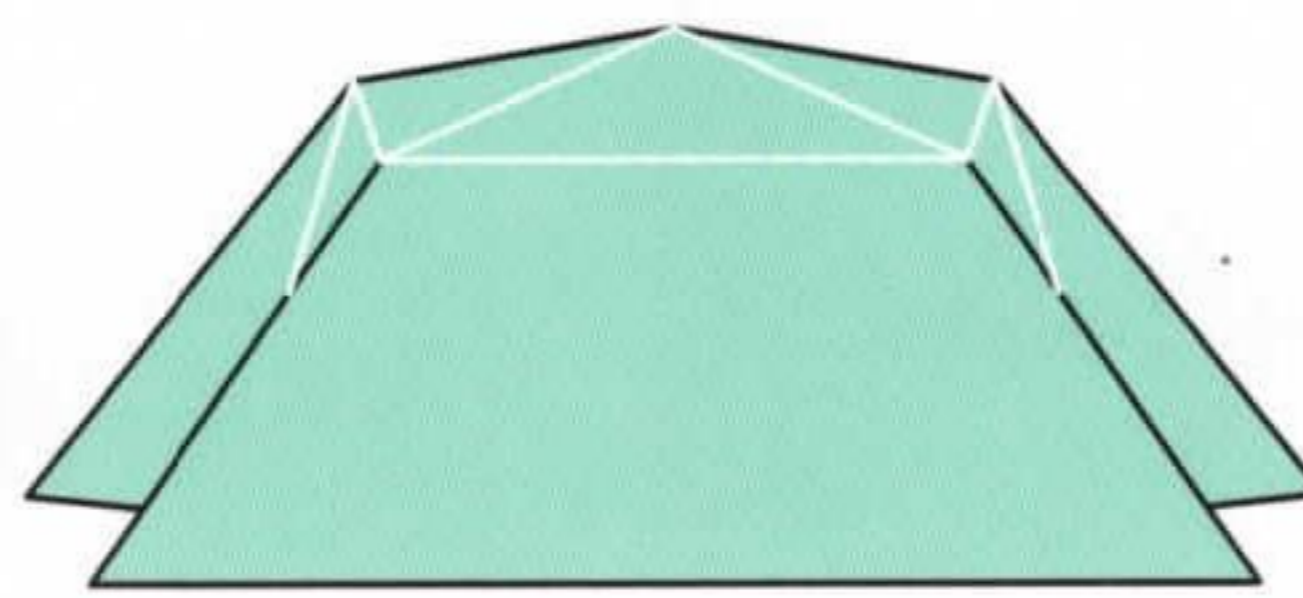

10. Before complete

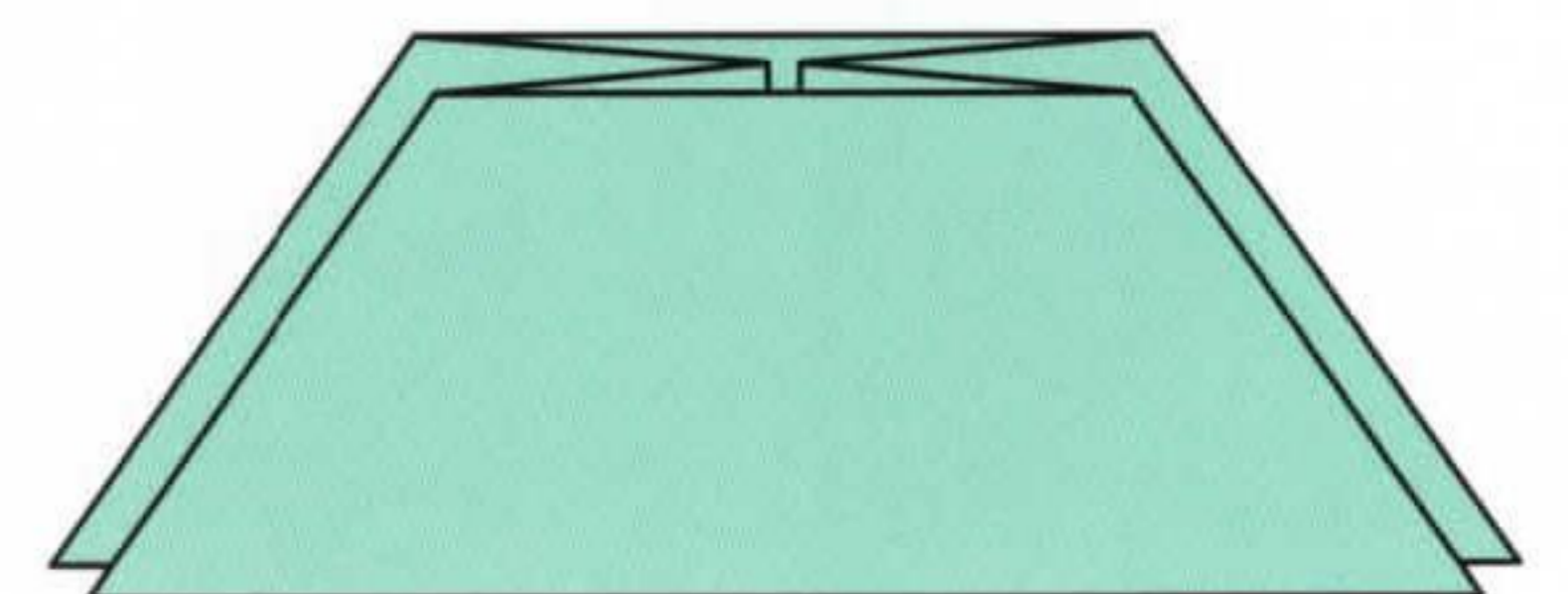

11. Completed SINK FOLD

BIRD BASE

1. Valley fold

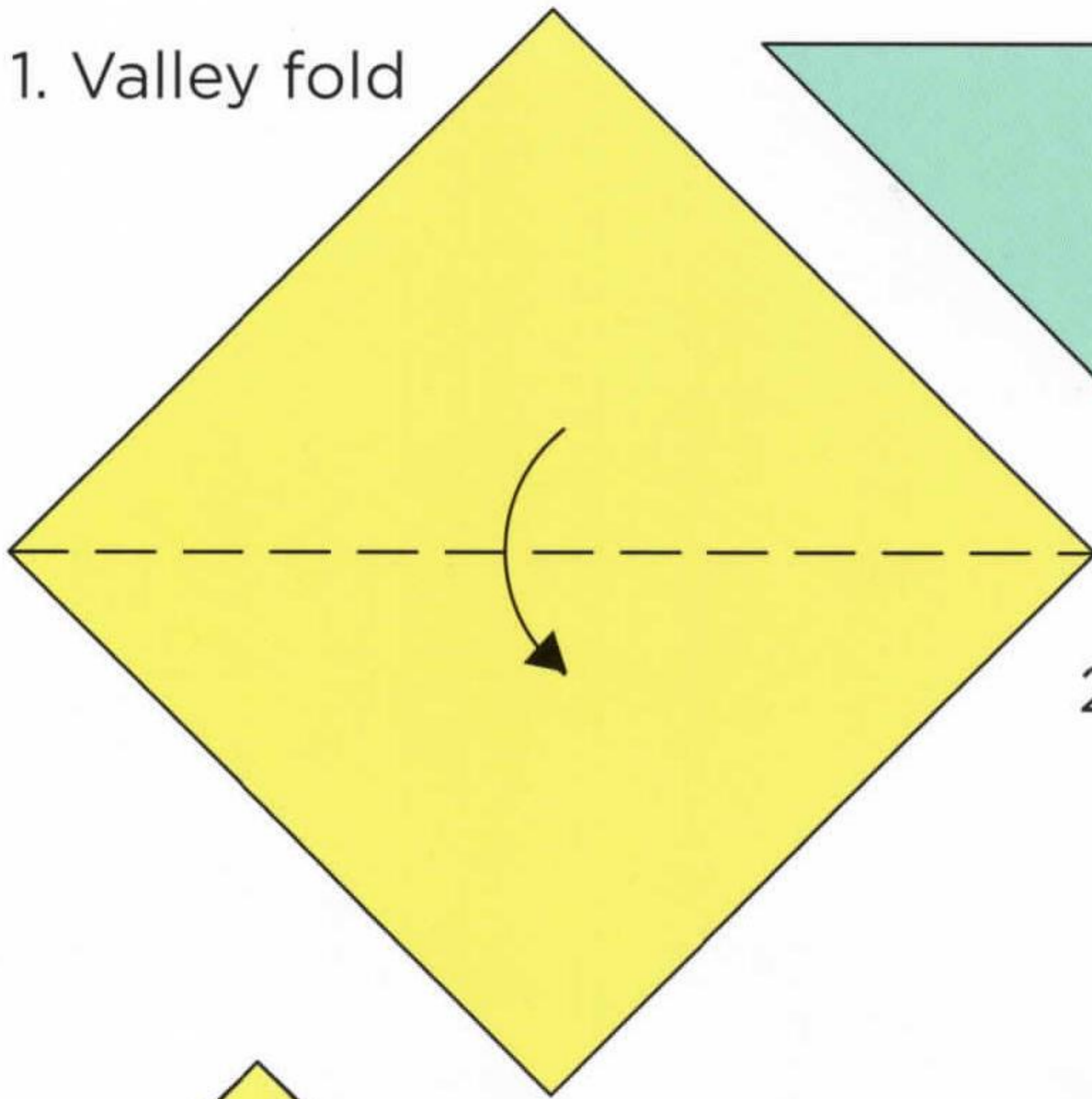

2. Valley fold and unfold

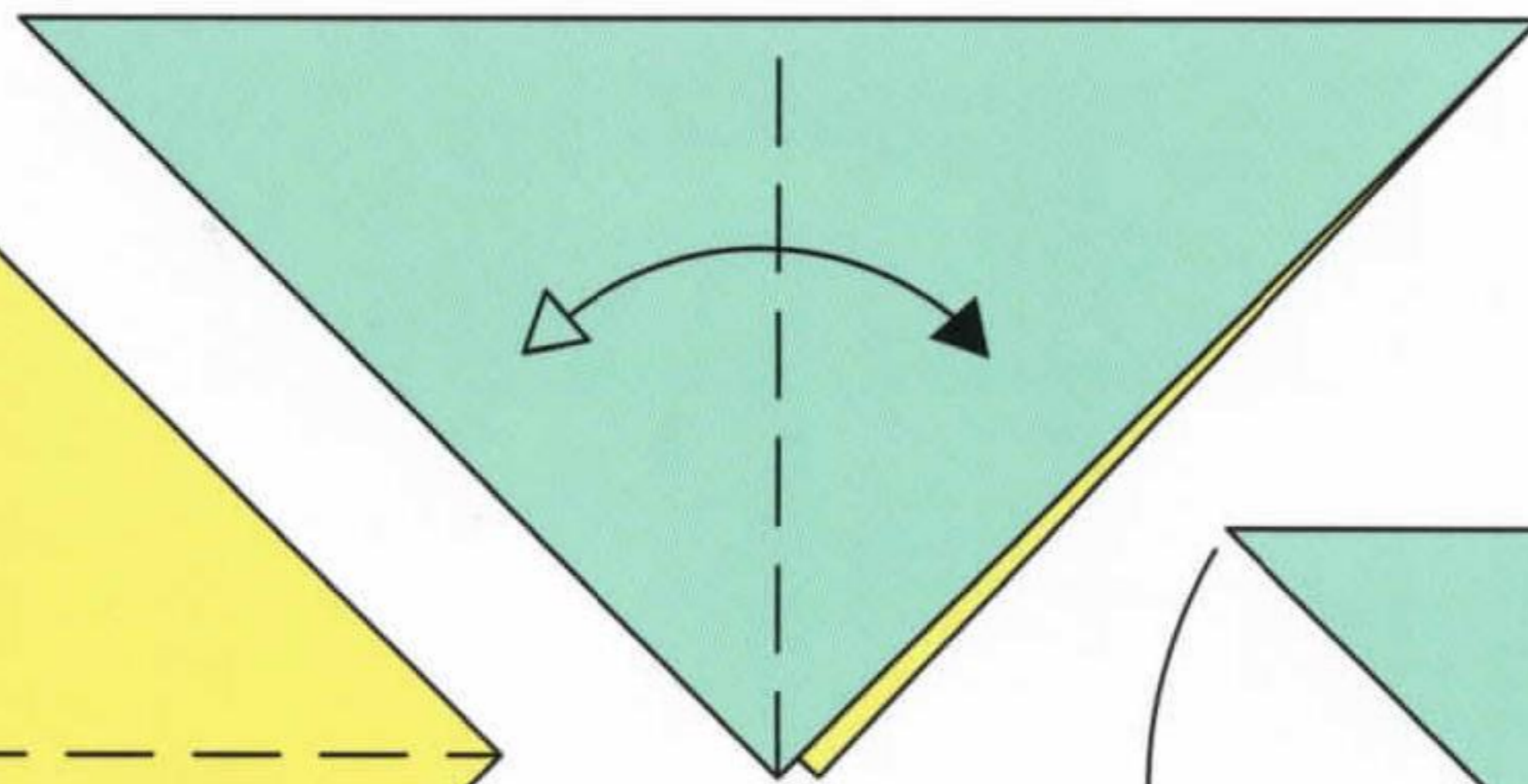

3. Inside reverse folds

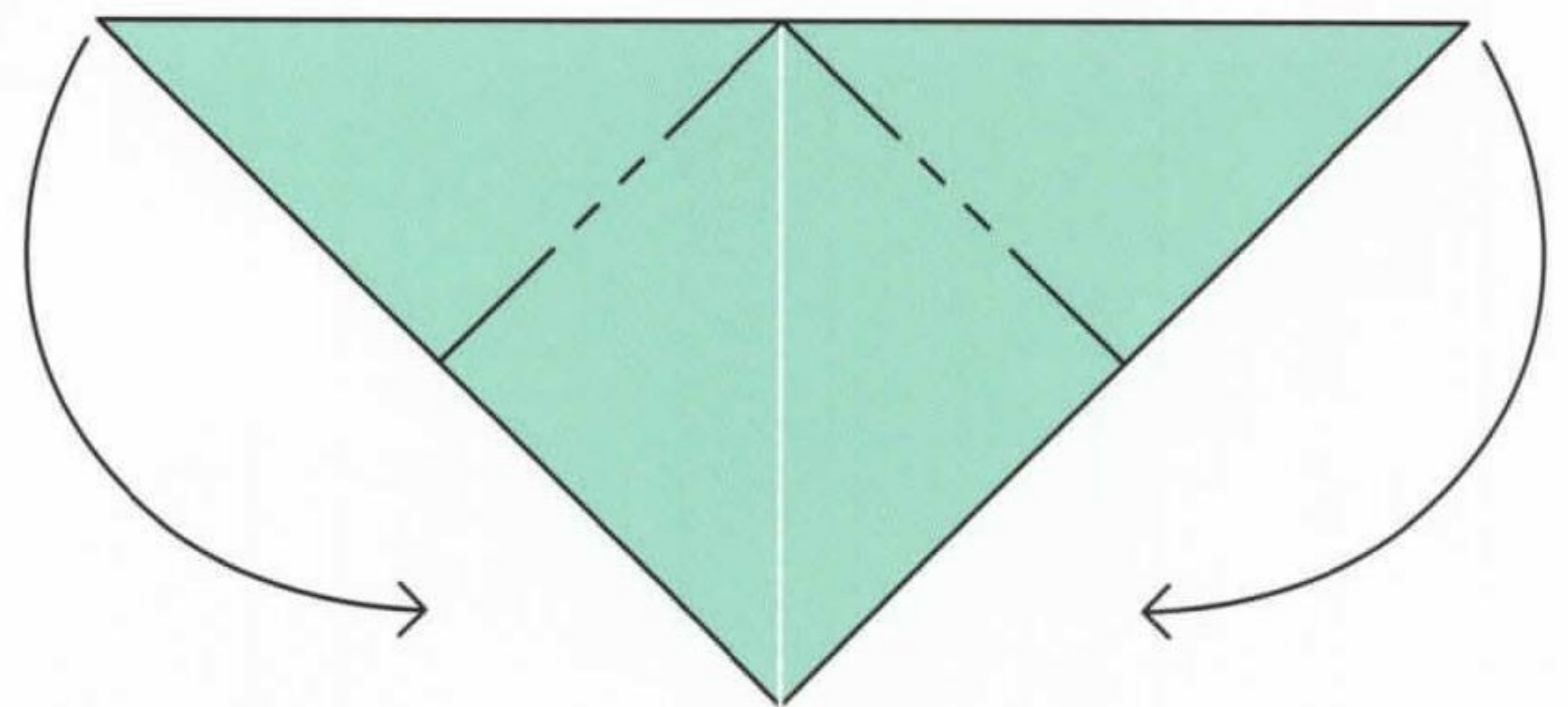

4. Valley fold and unfold

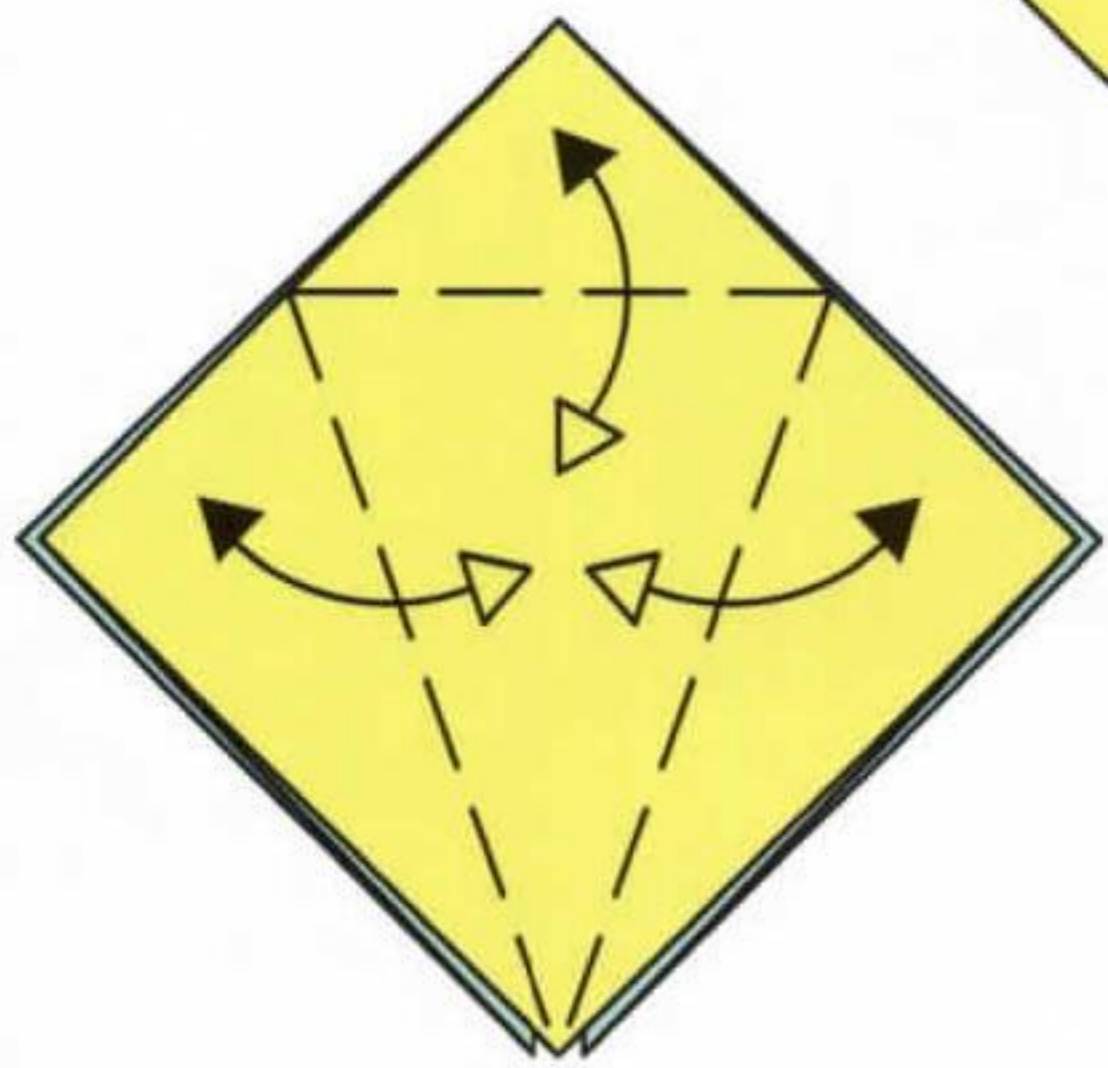

5. Pull and fold

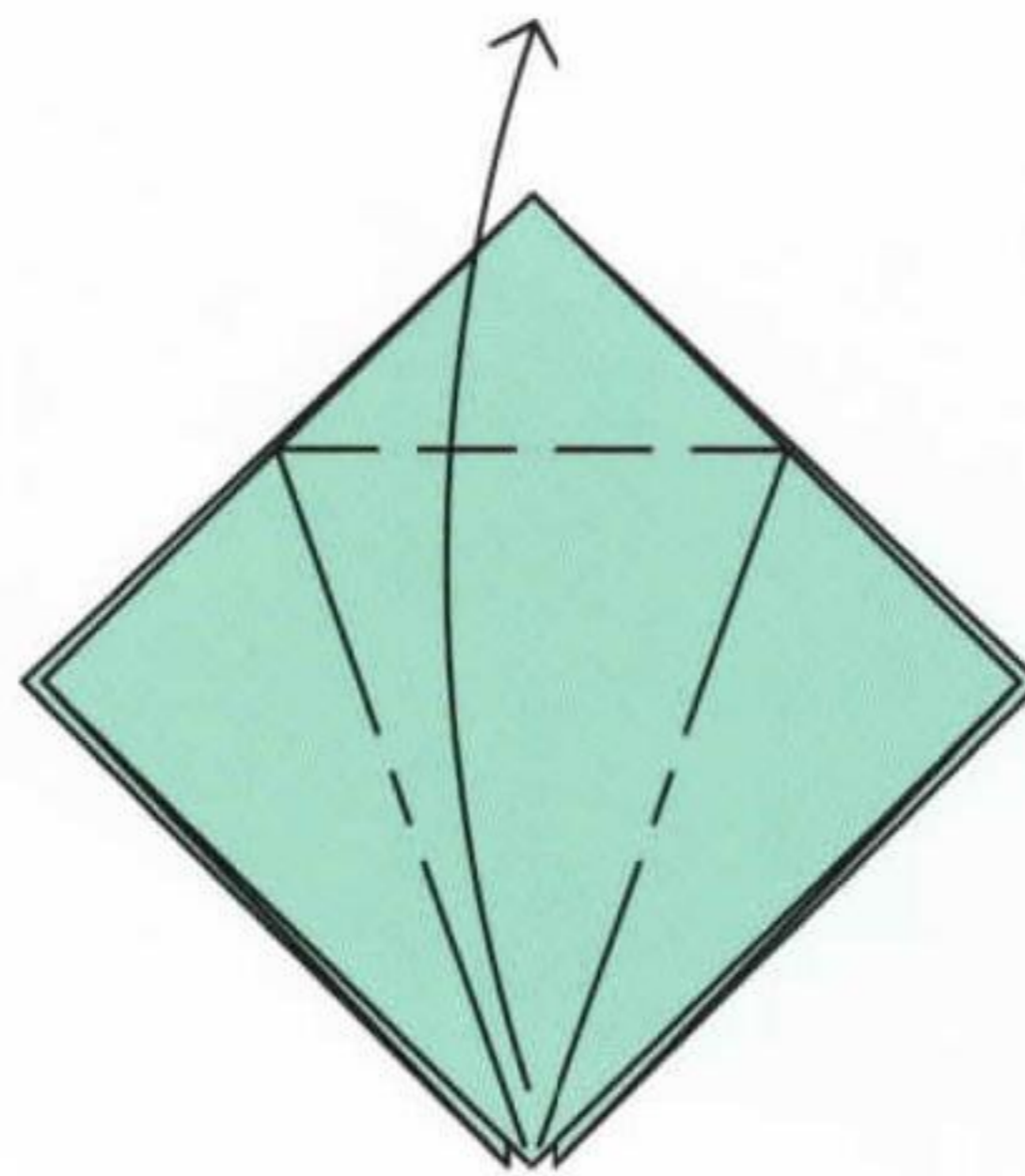

6. Before complete

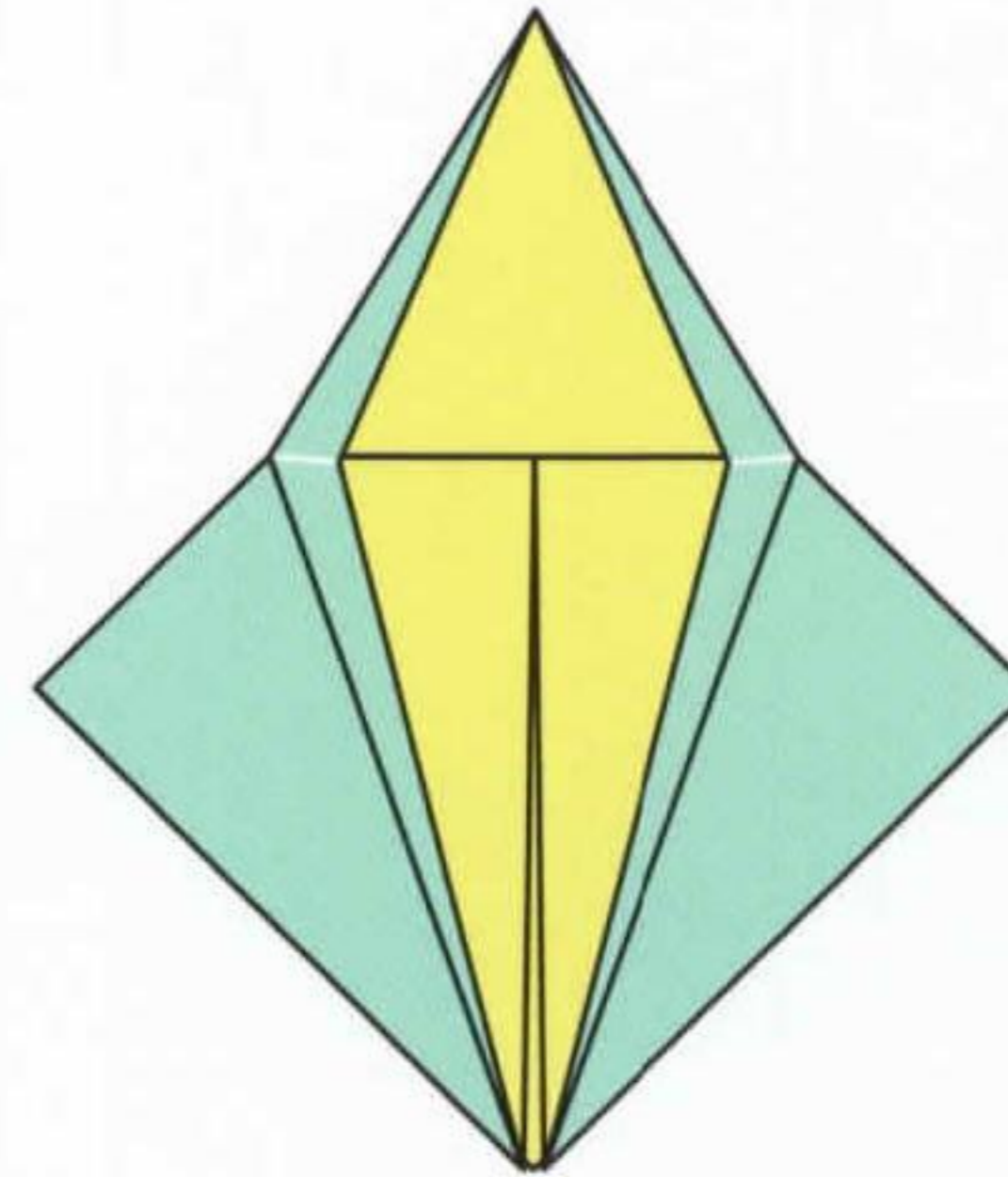

7. Turn over

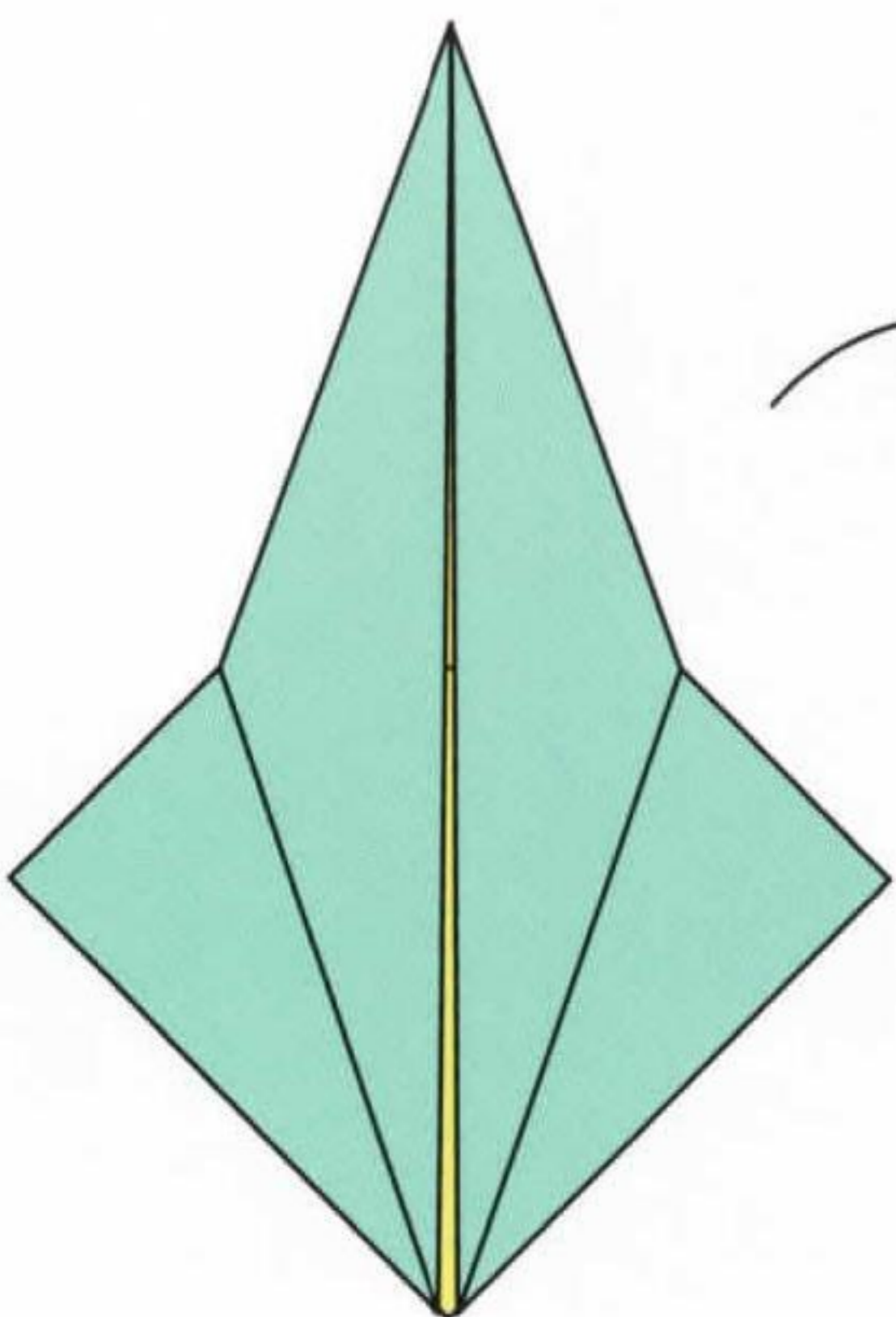

8. Valley fold and unfold

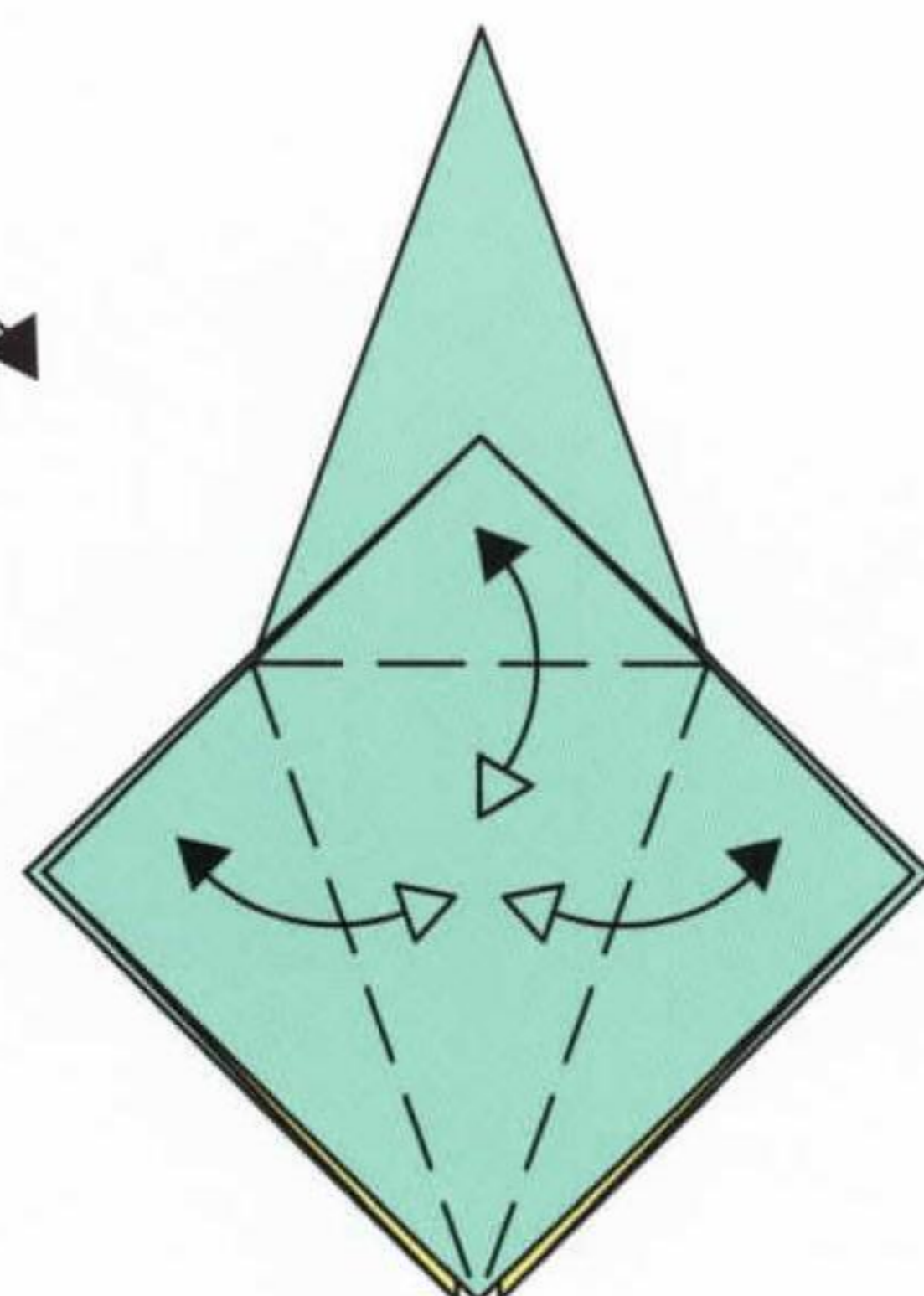

9. Pull and fold

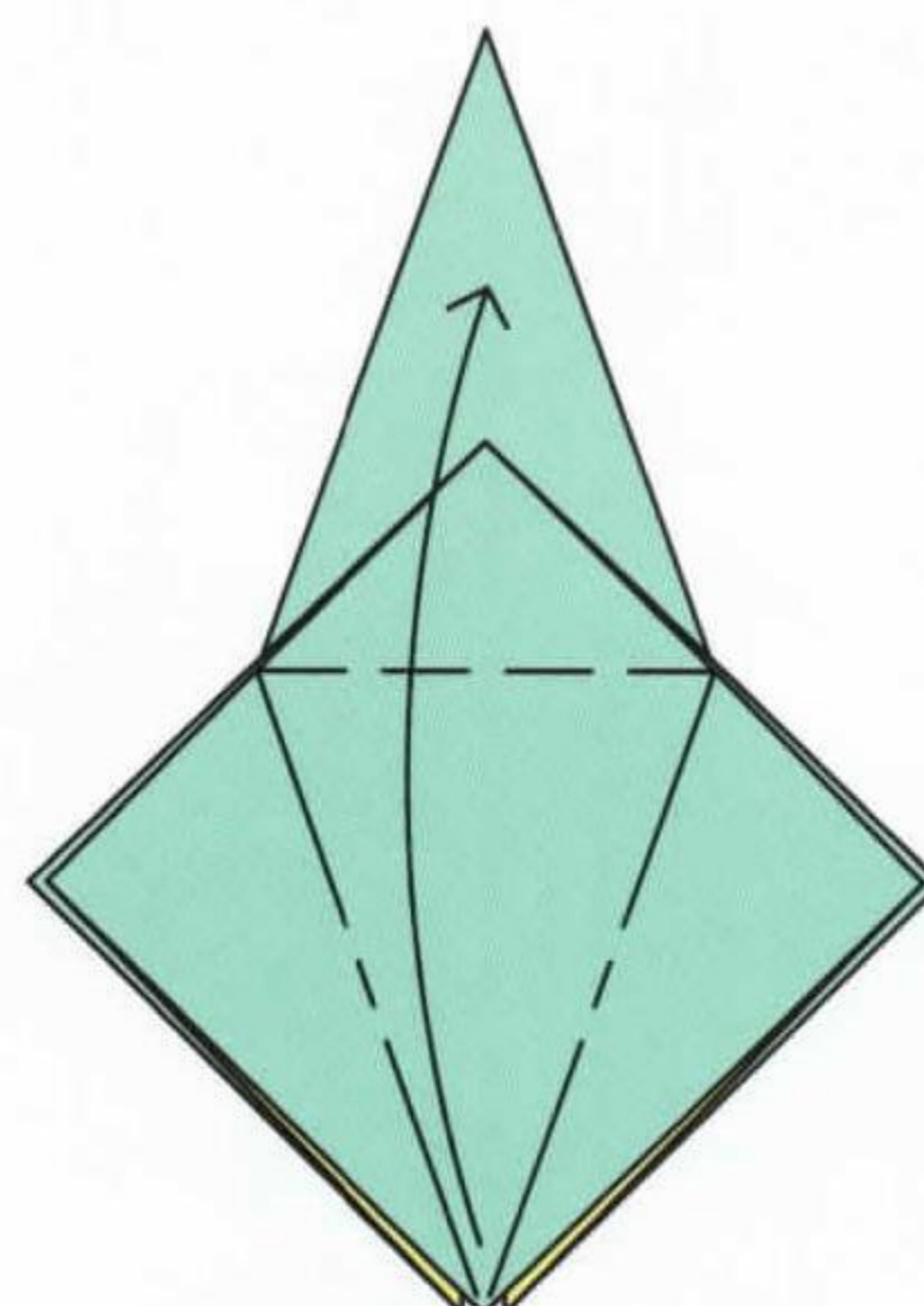

10. Completed BIRD BASE

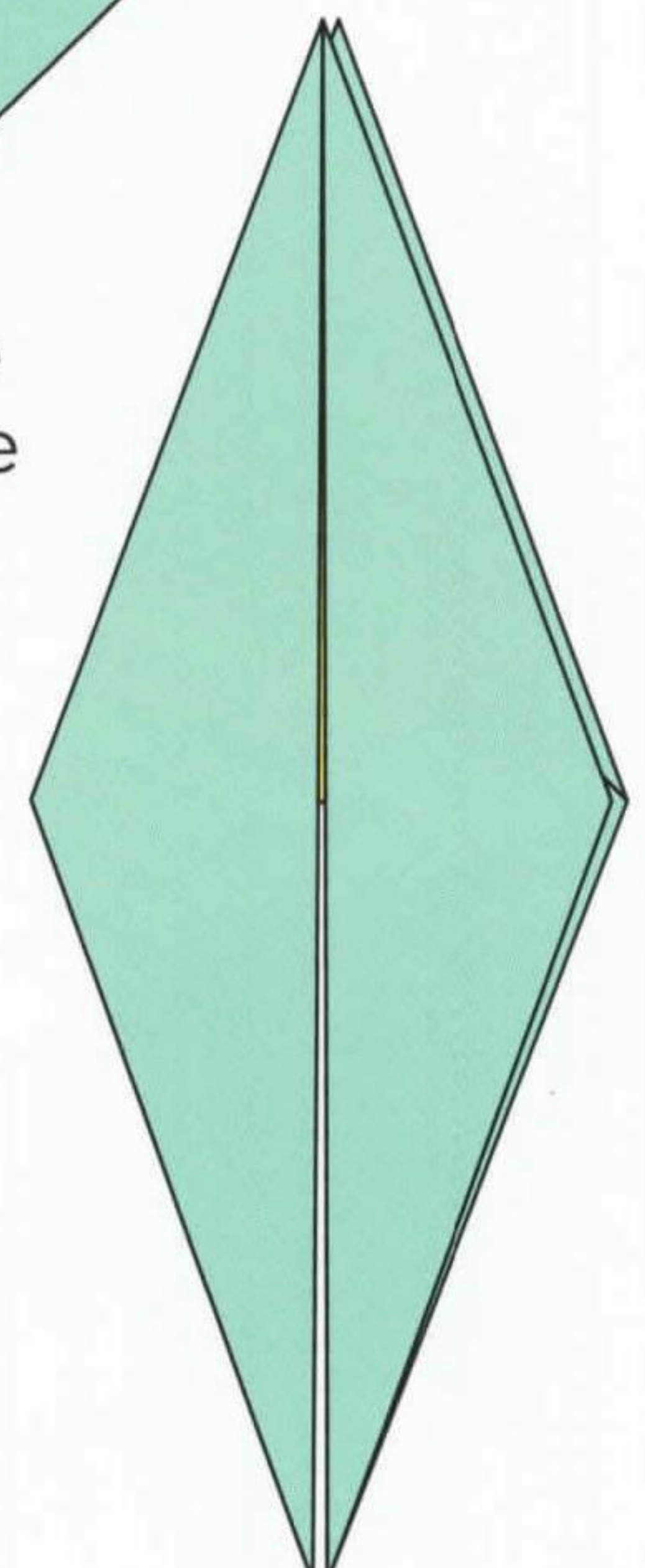



1

living room

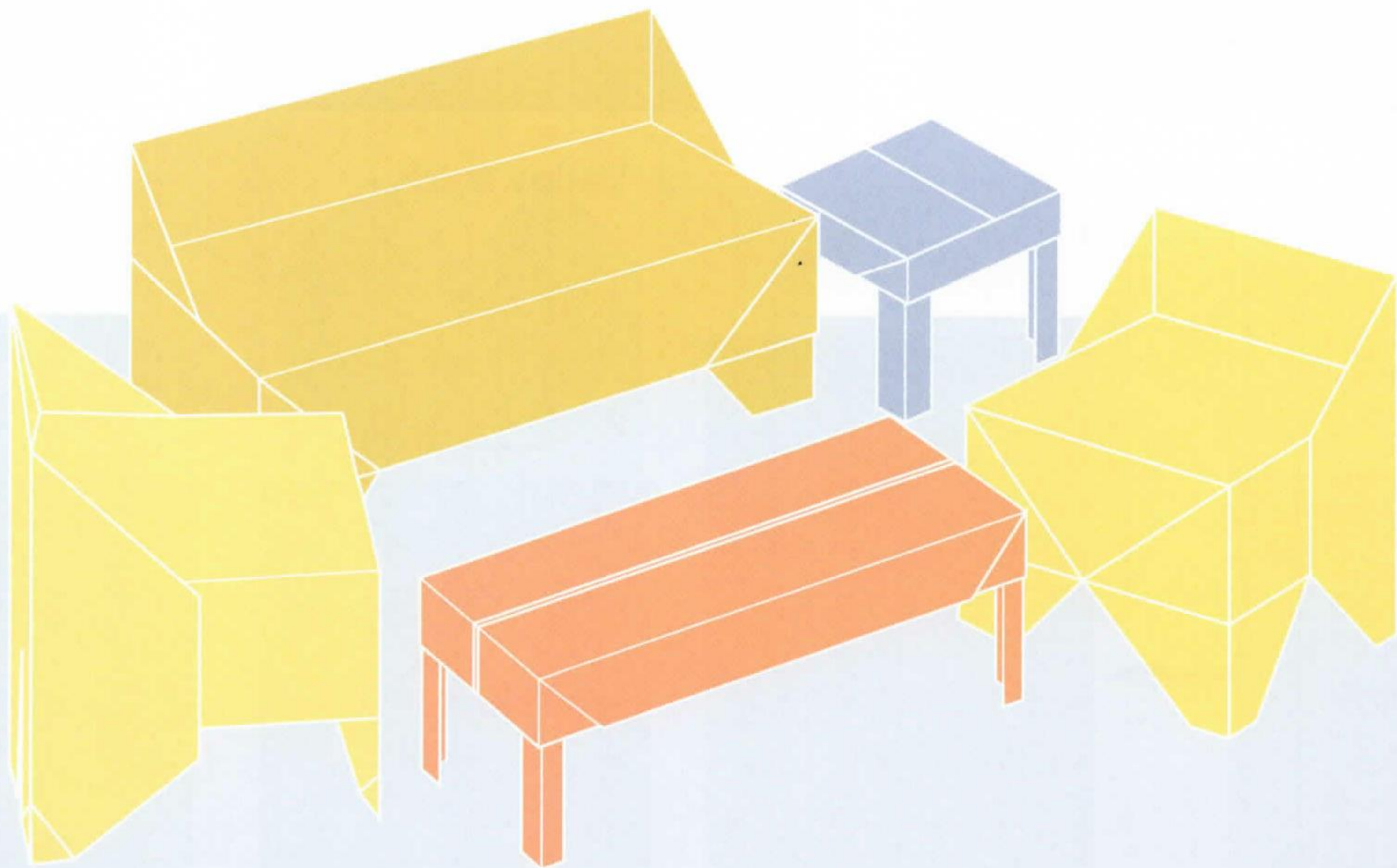

chair | coffee table | couch | end table

➤ chair

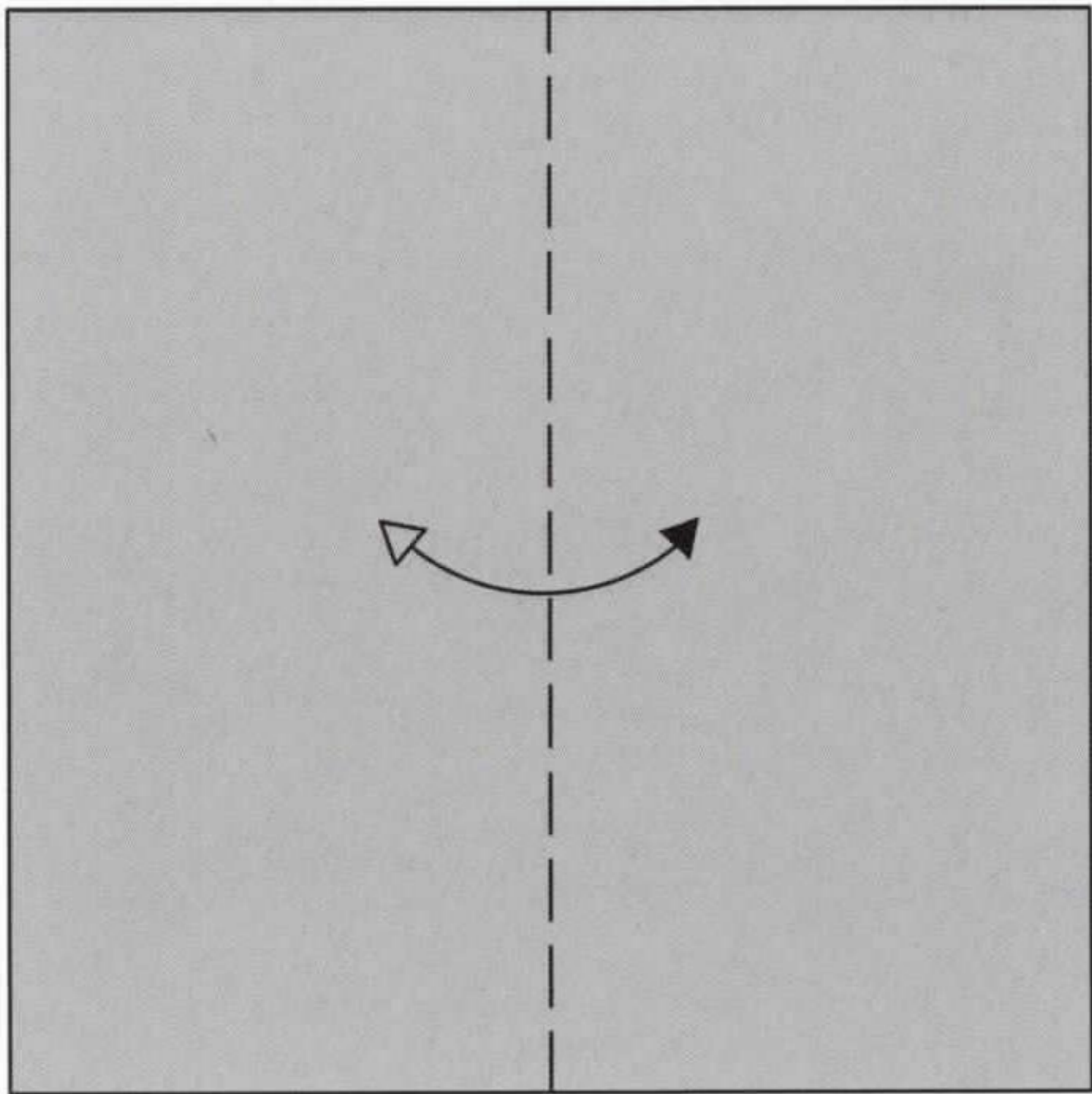

1. Valley fold and unfold

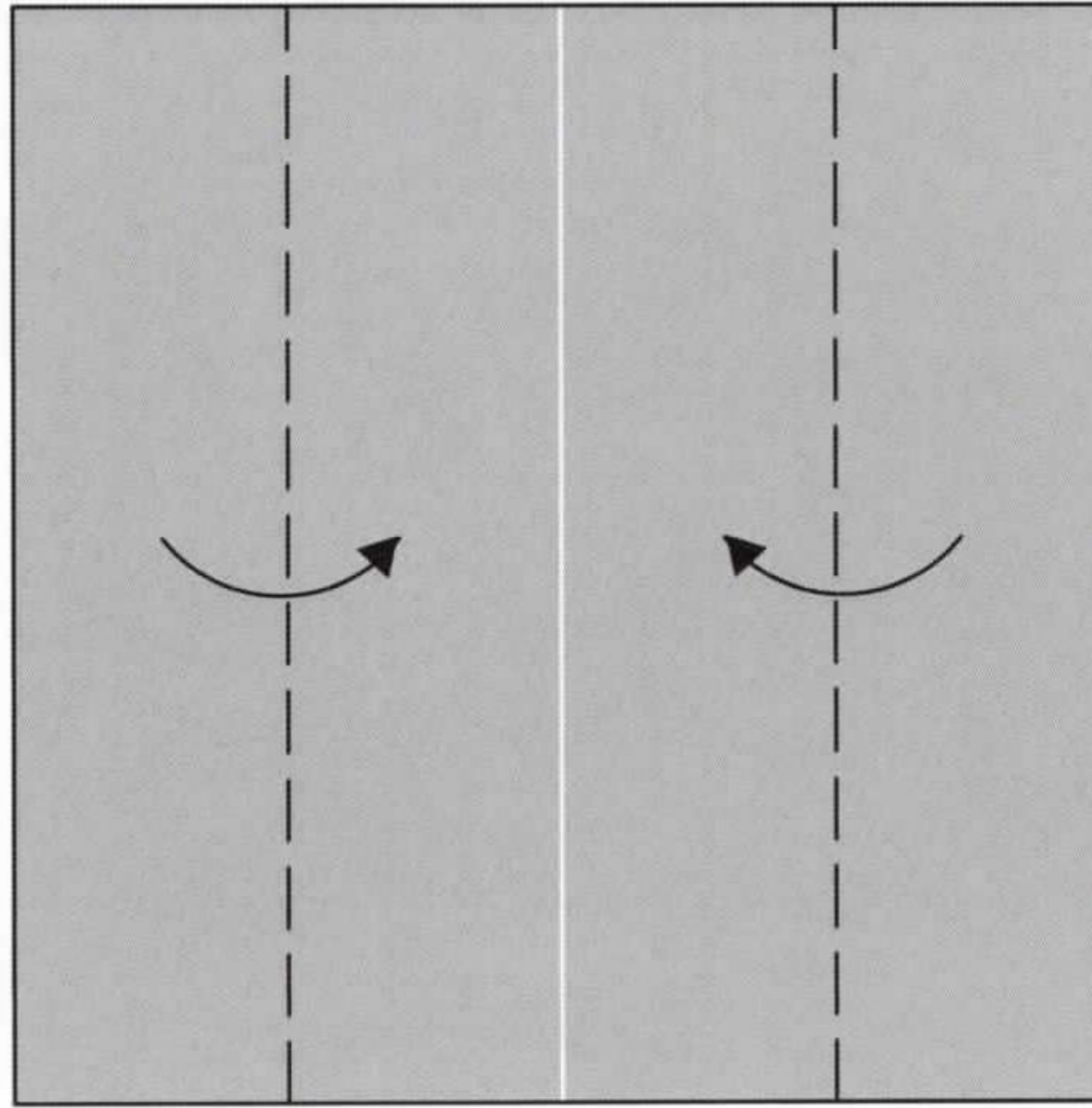

2. Valley folds

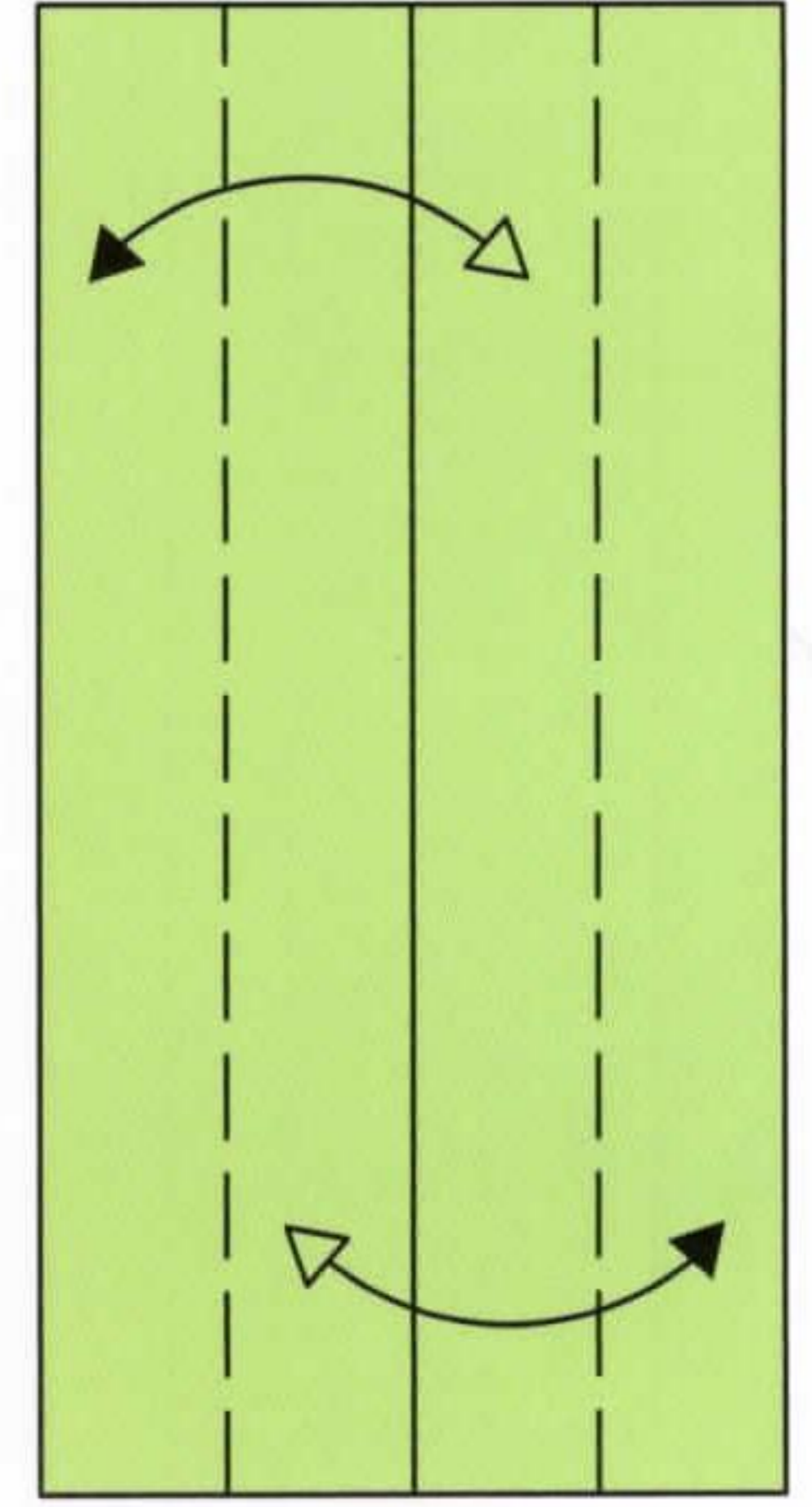

3. Valley fold and unfold

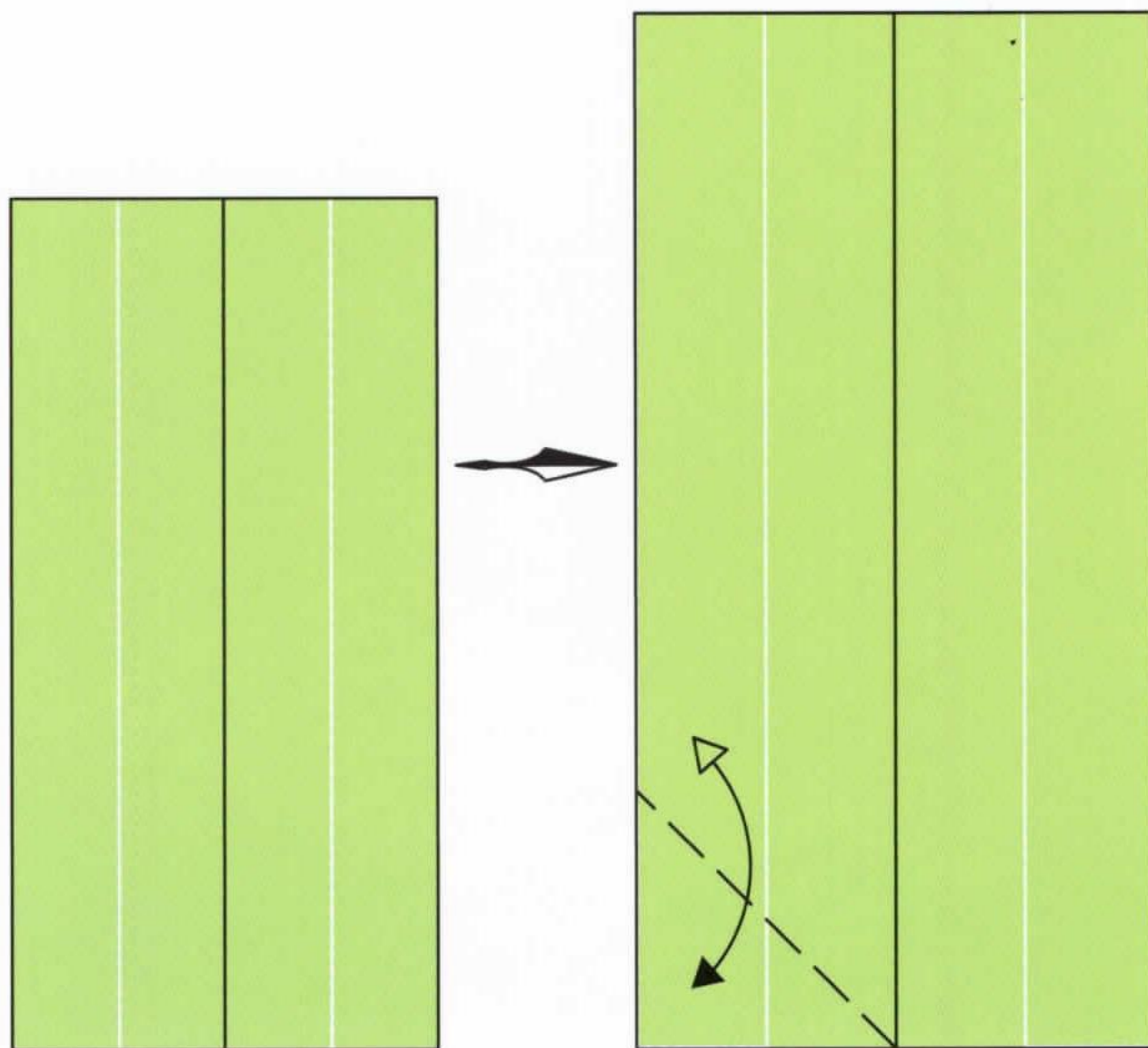

4. Scale-up

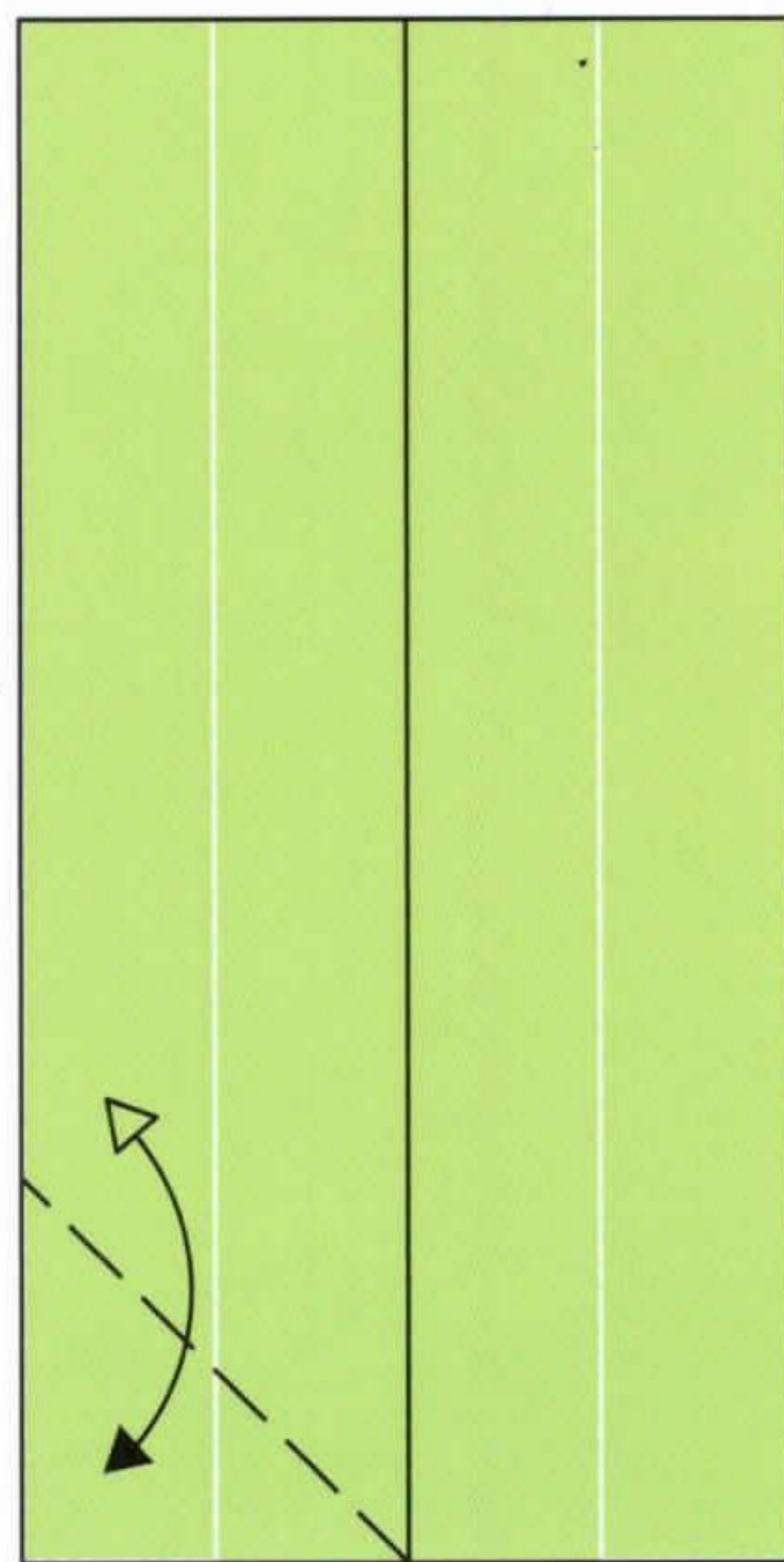

5. Valley fold and unfold

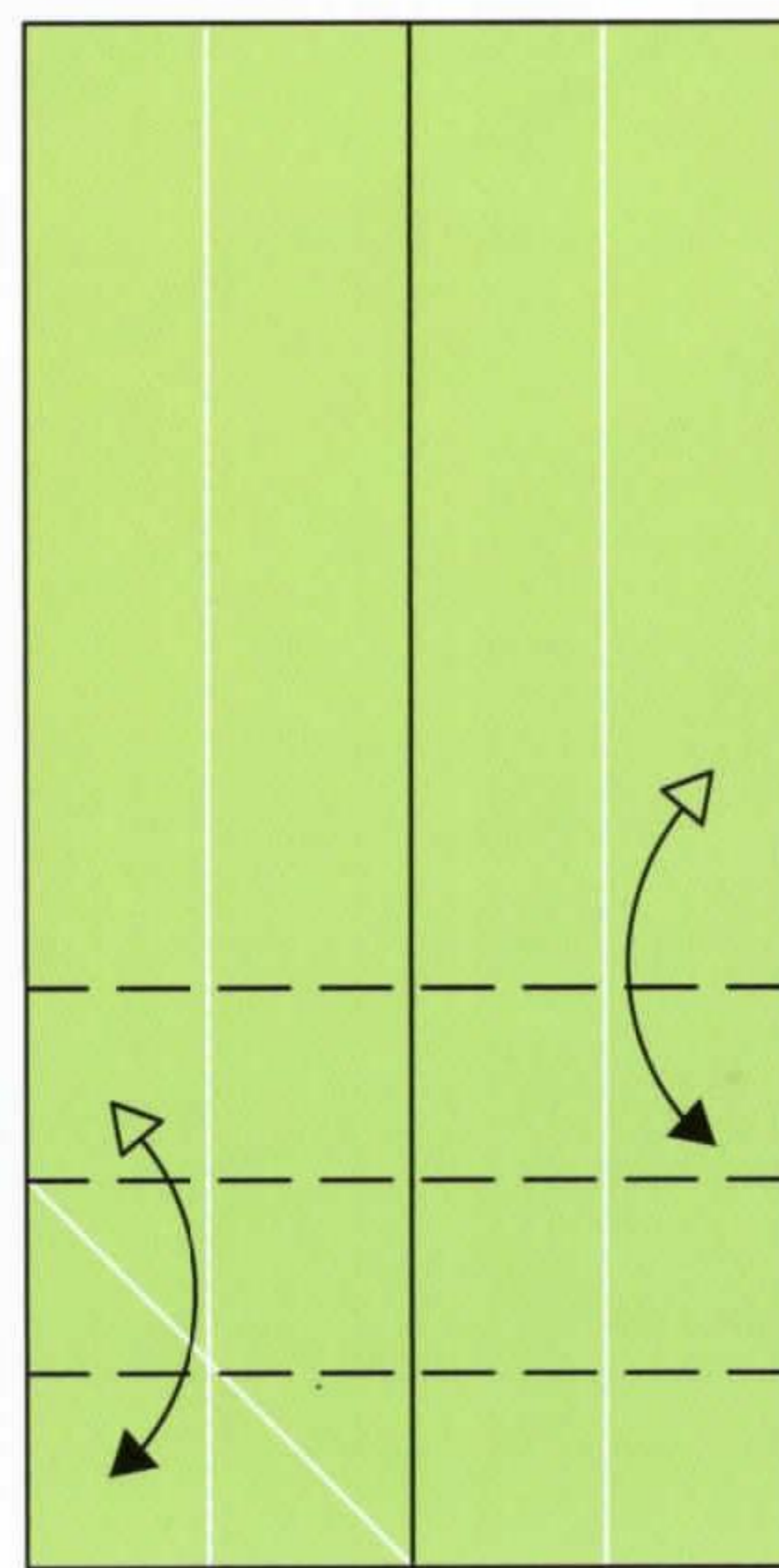

6. Repeat

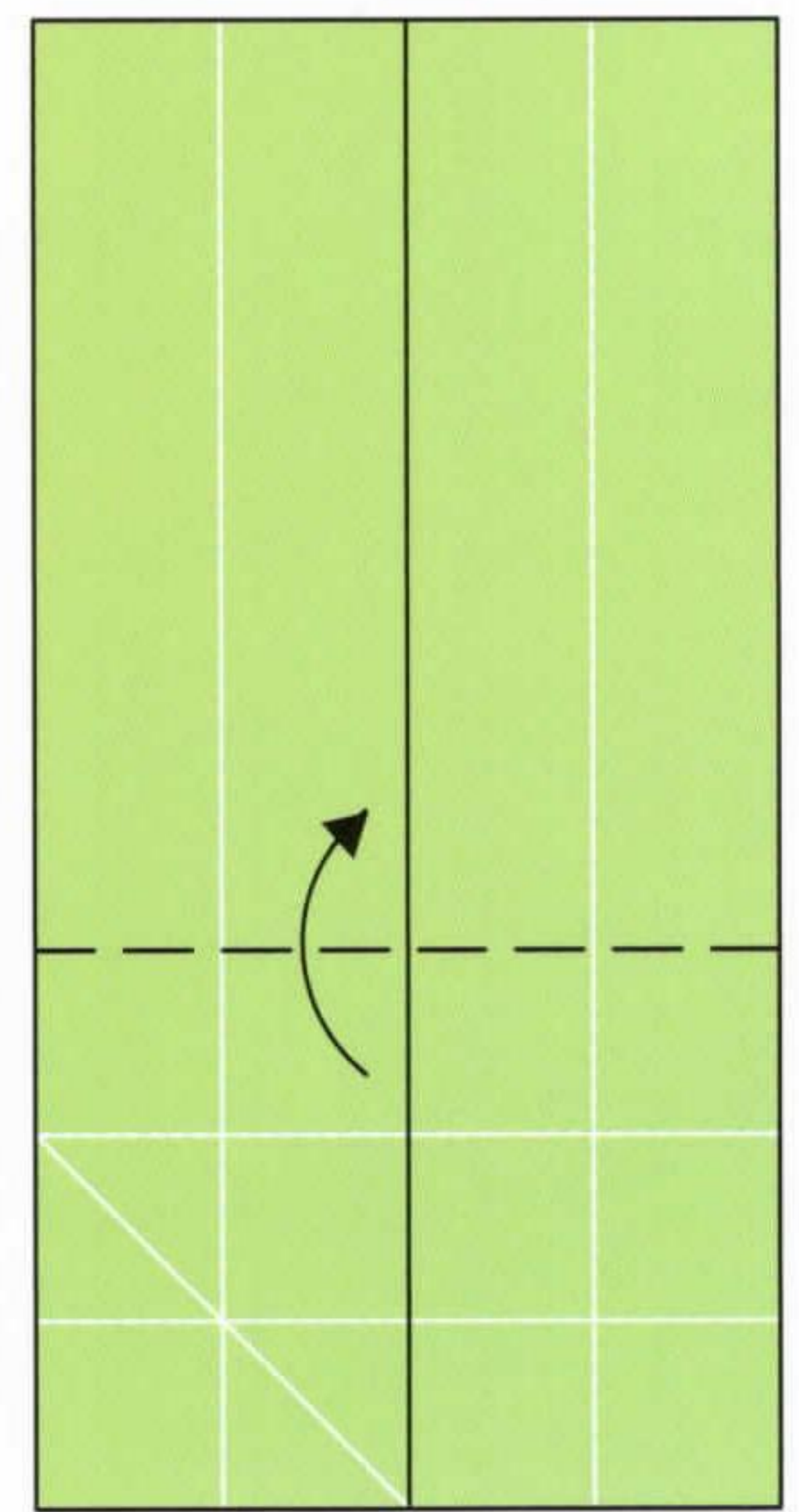

7. Valley fold

chair

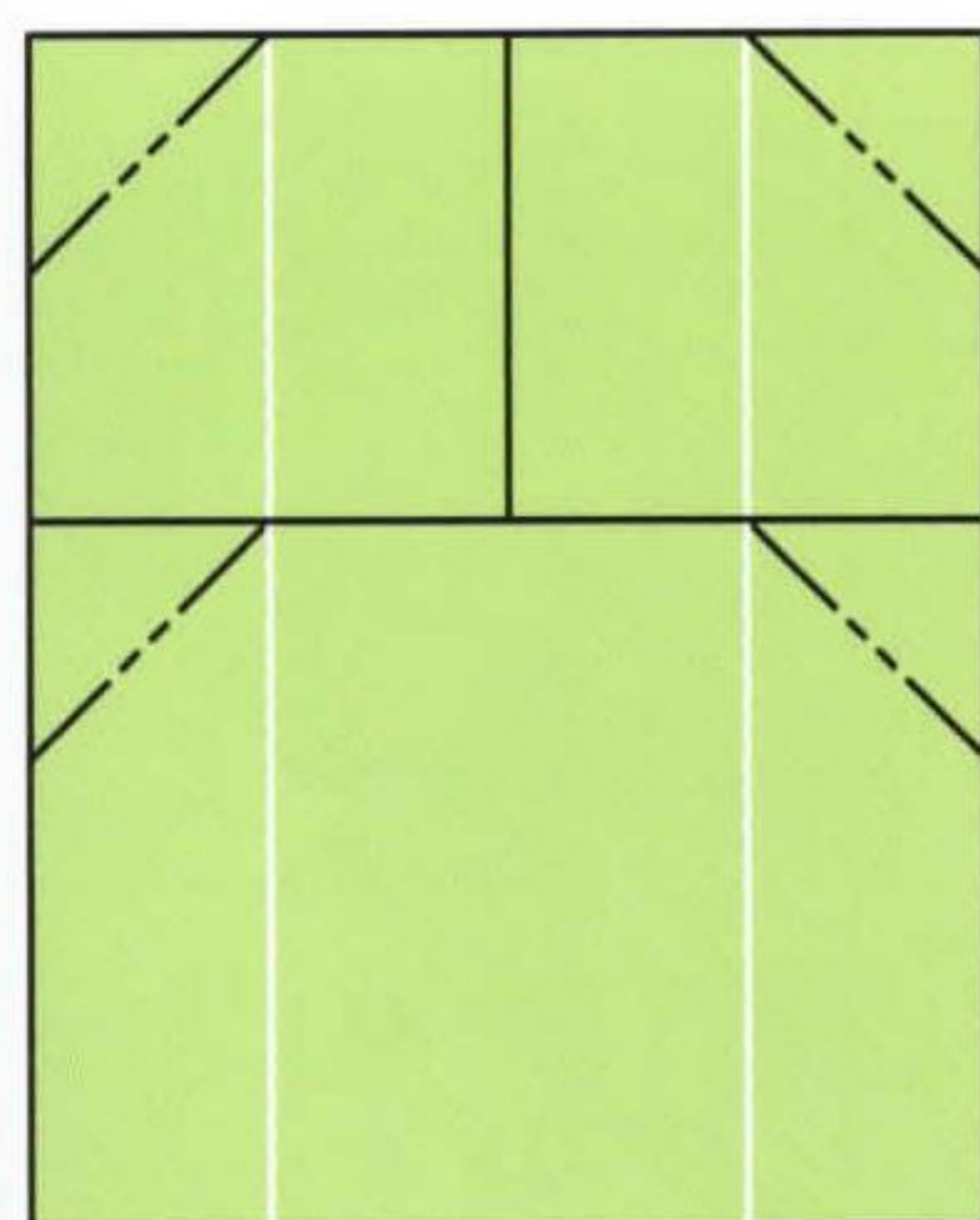

8. Inside reverse folds

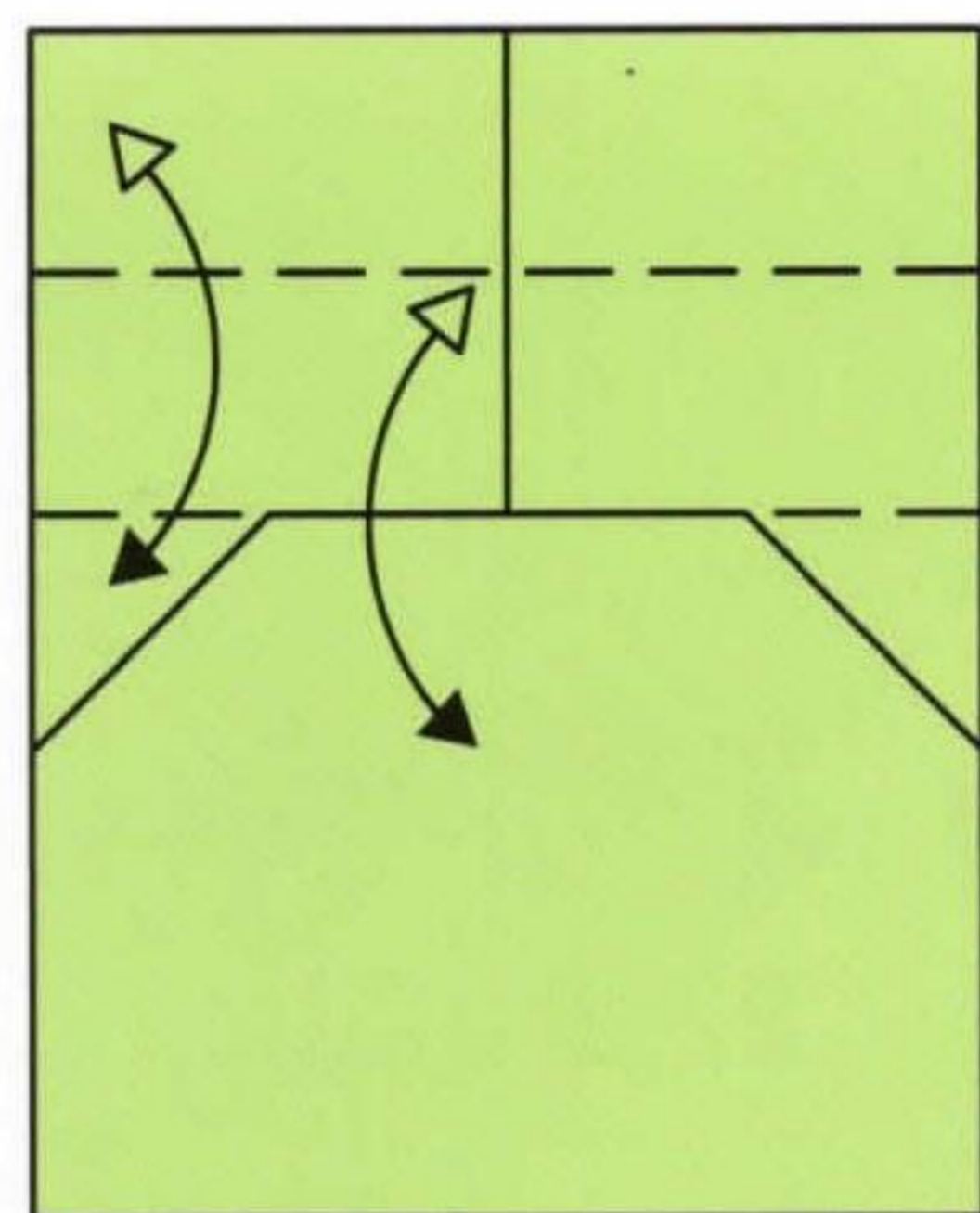

9. Valley fold and unfold

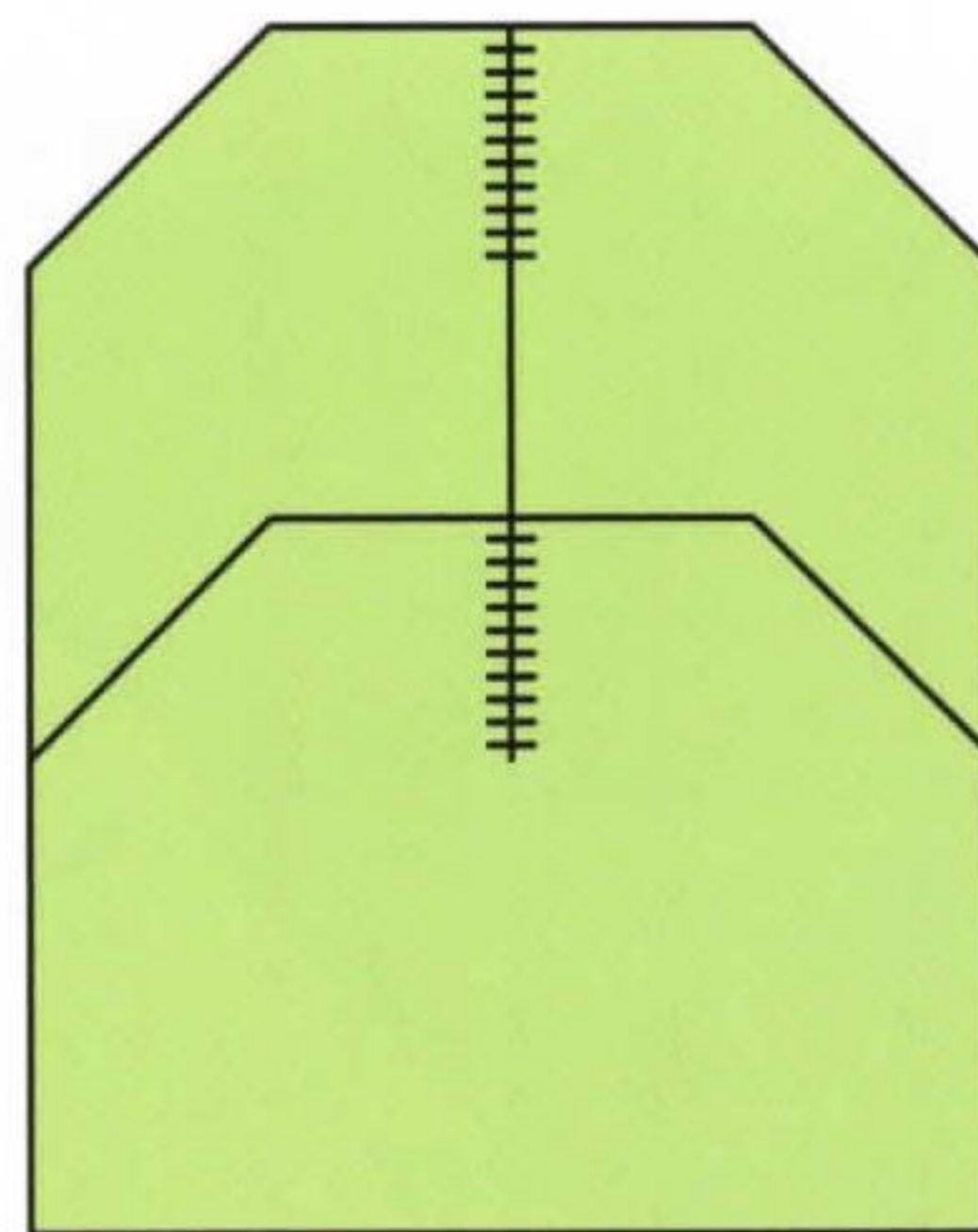

10. Cut as shown

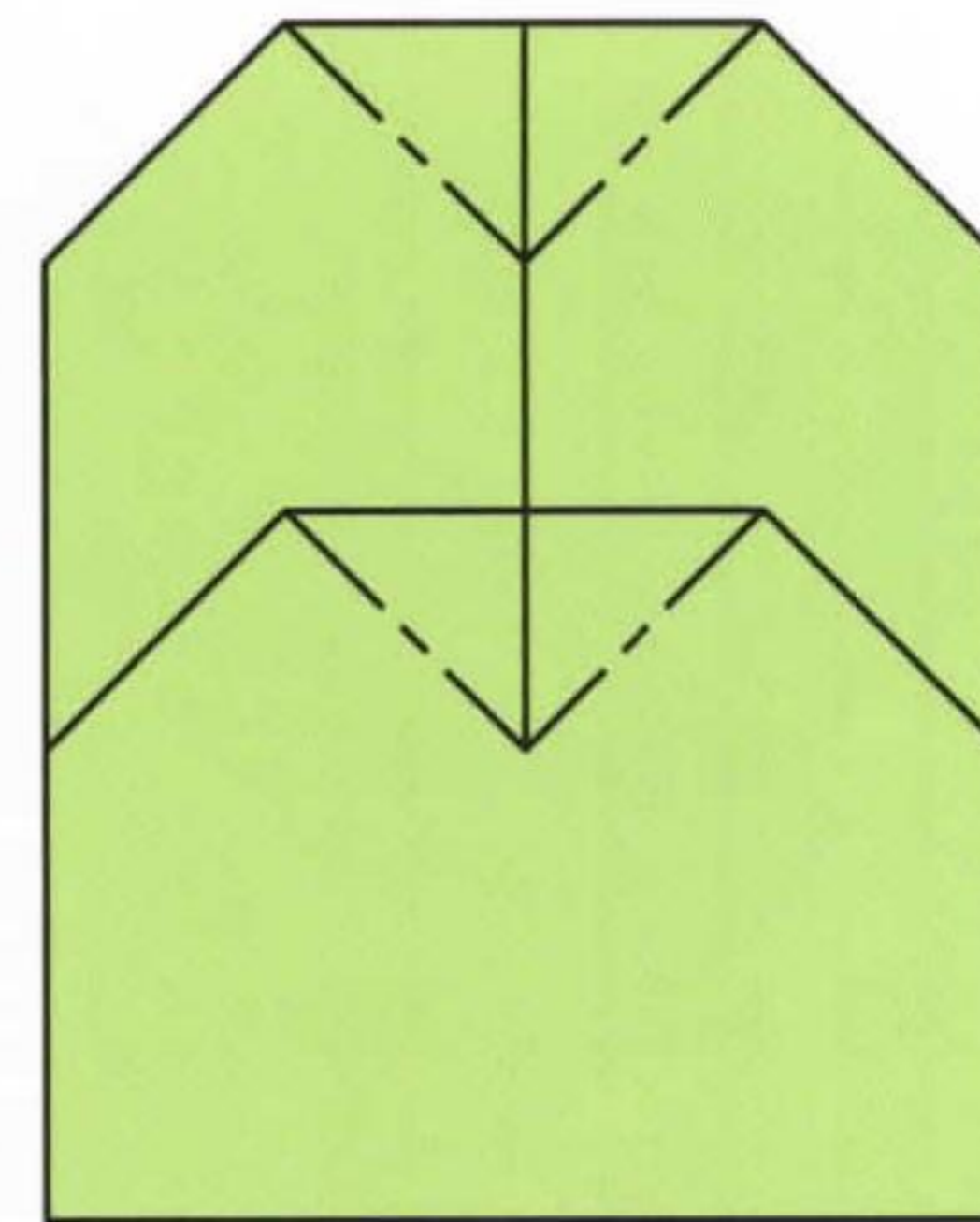

11. Mountain folds

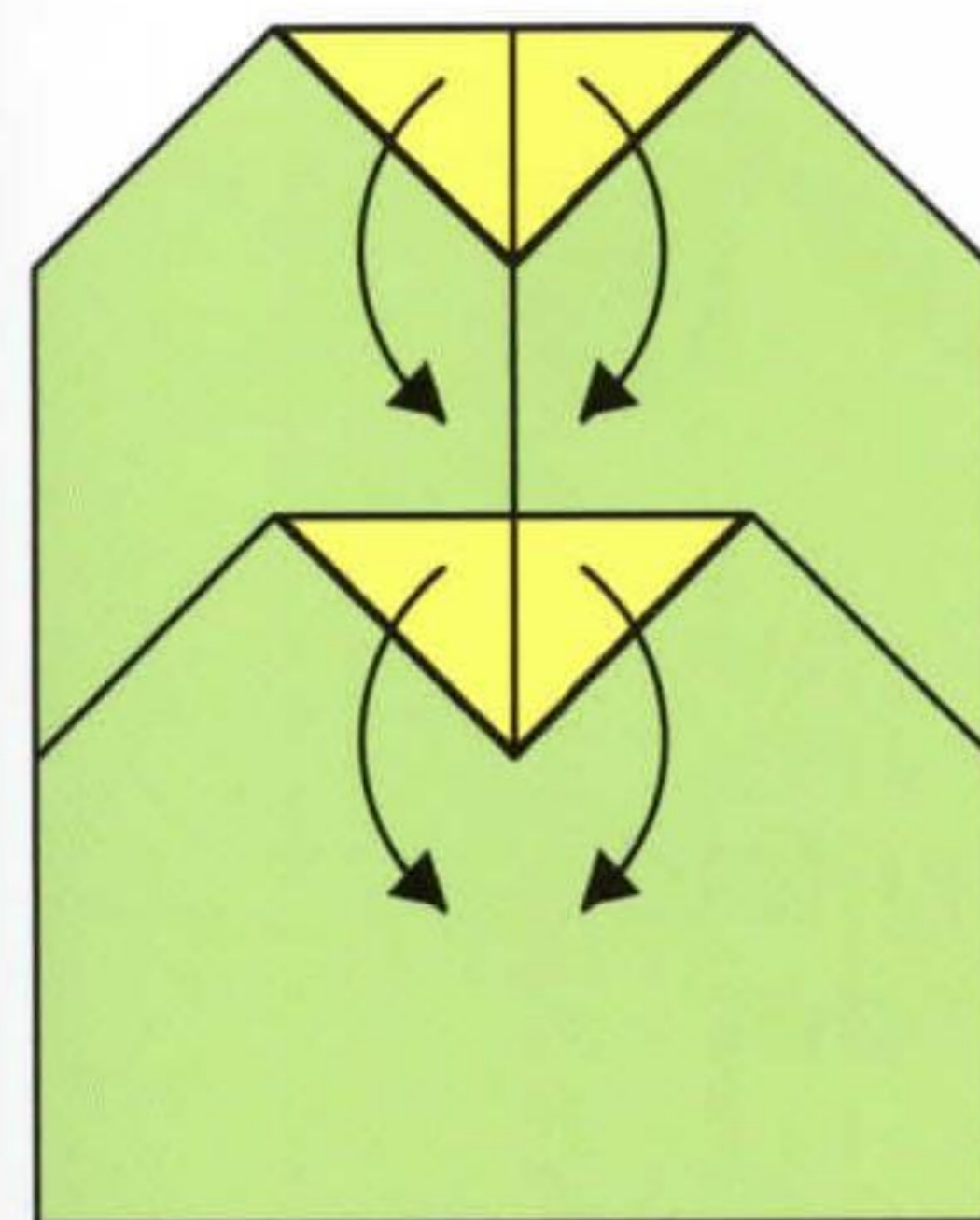

12. Valley folds

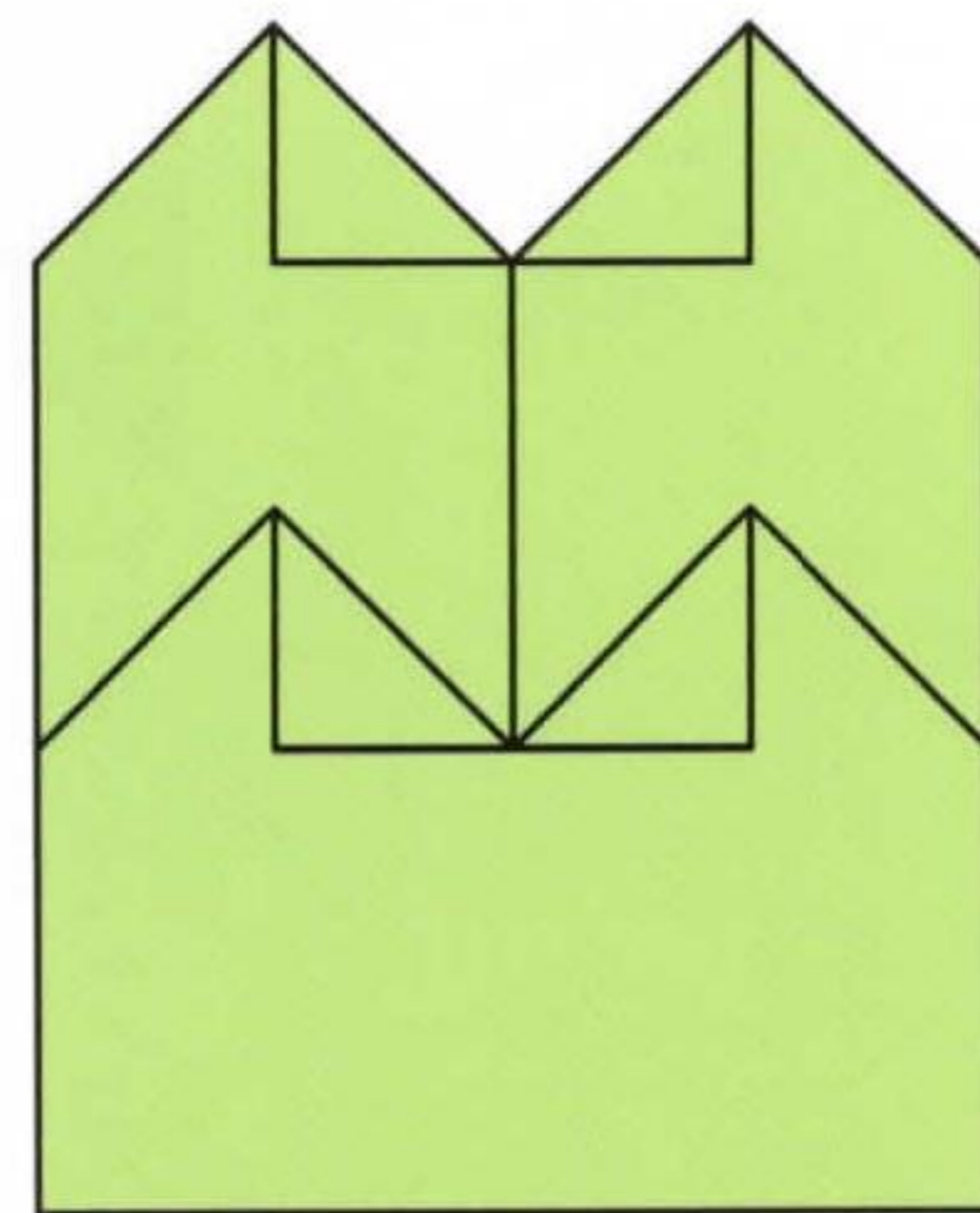

13. Hide behind layers

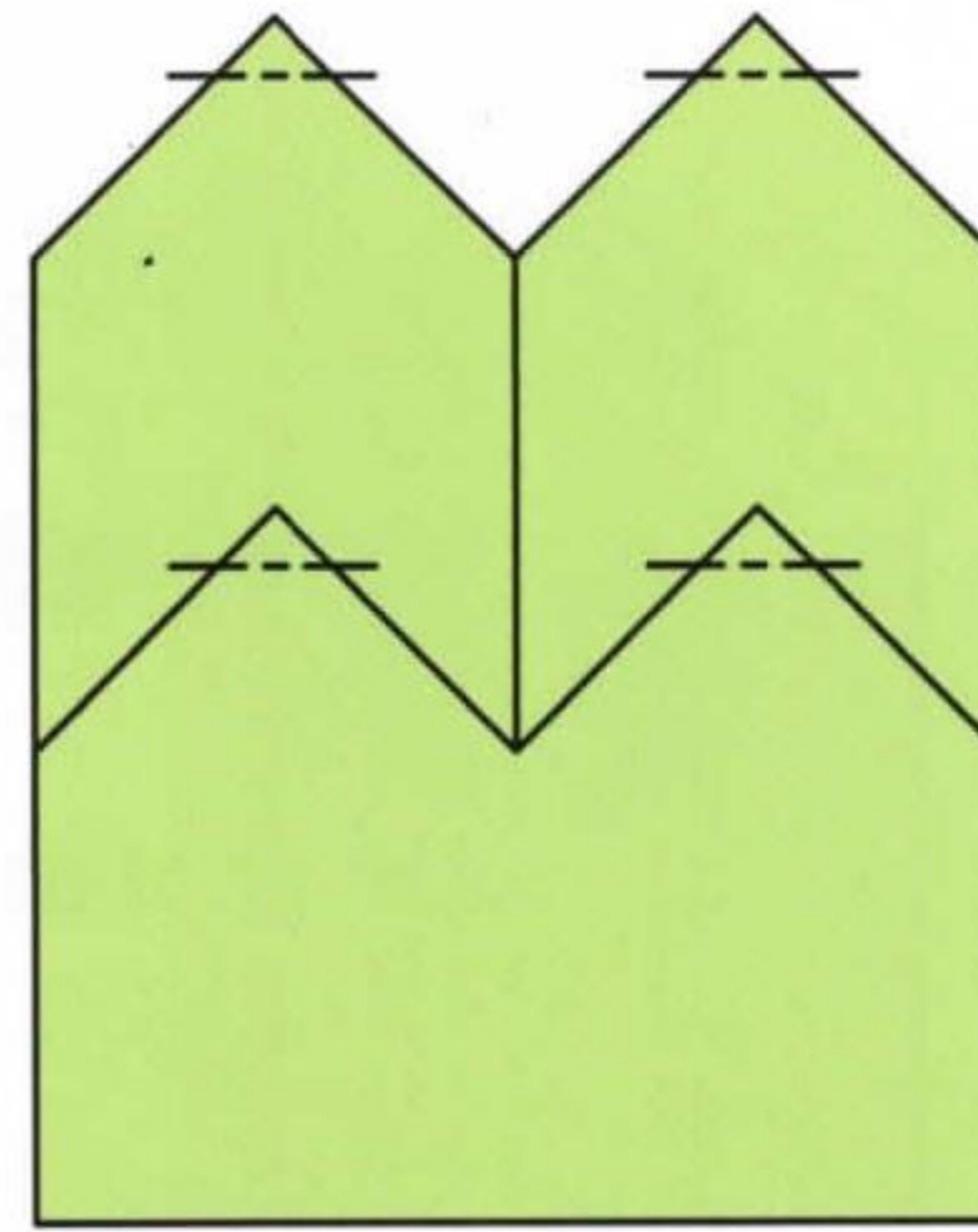

14. Mountain fold front

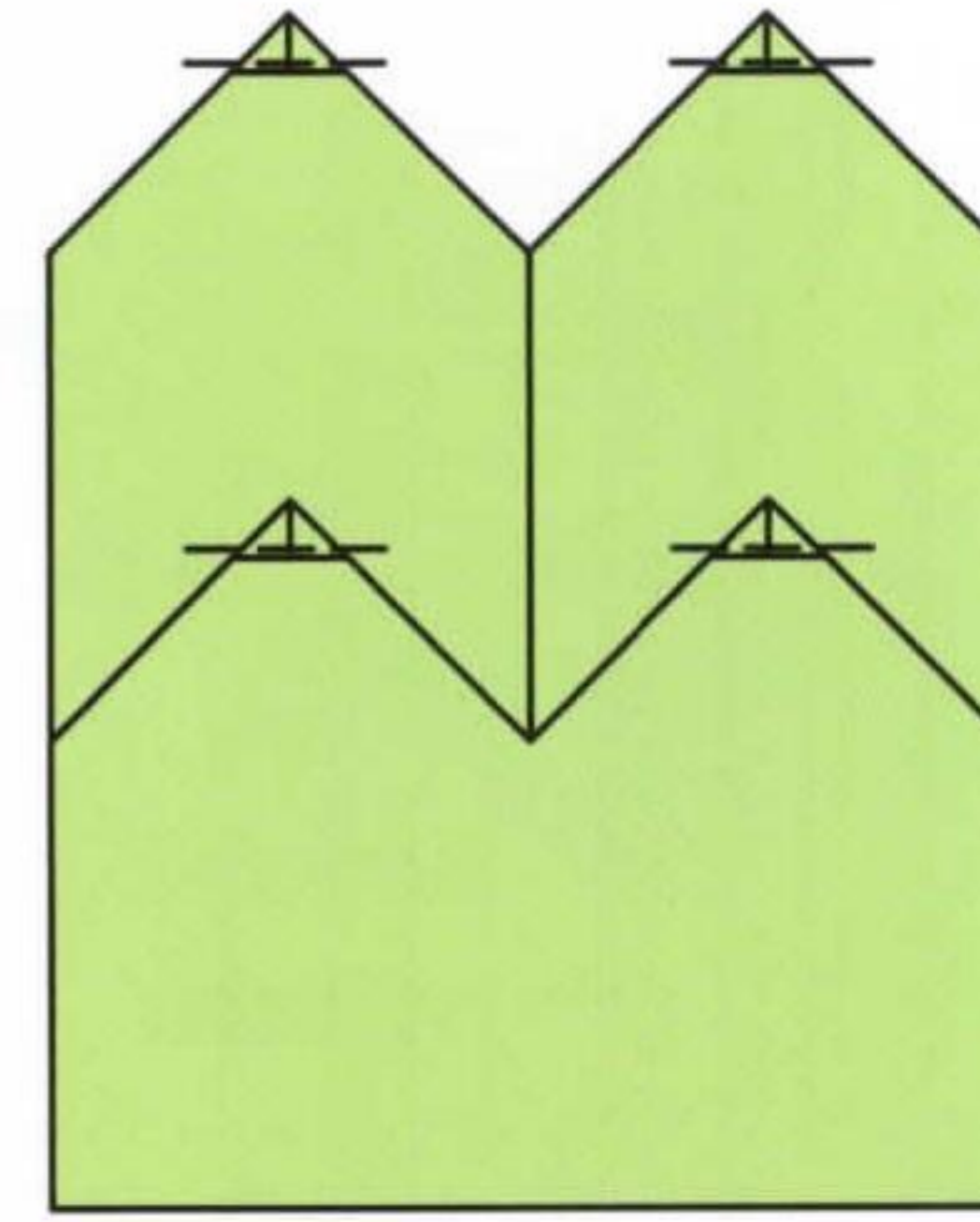

15. Valley folds back

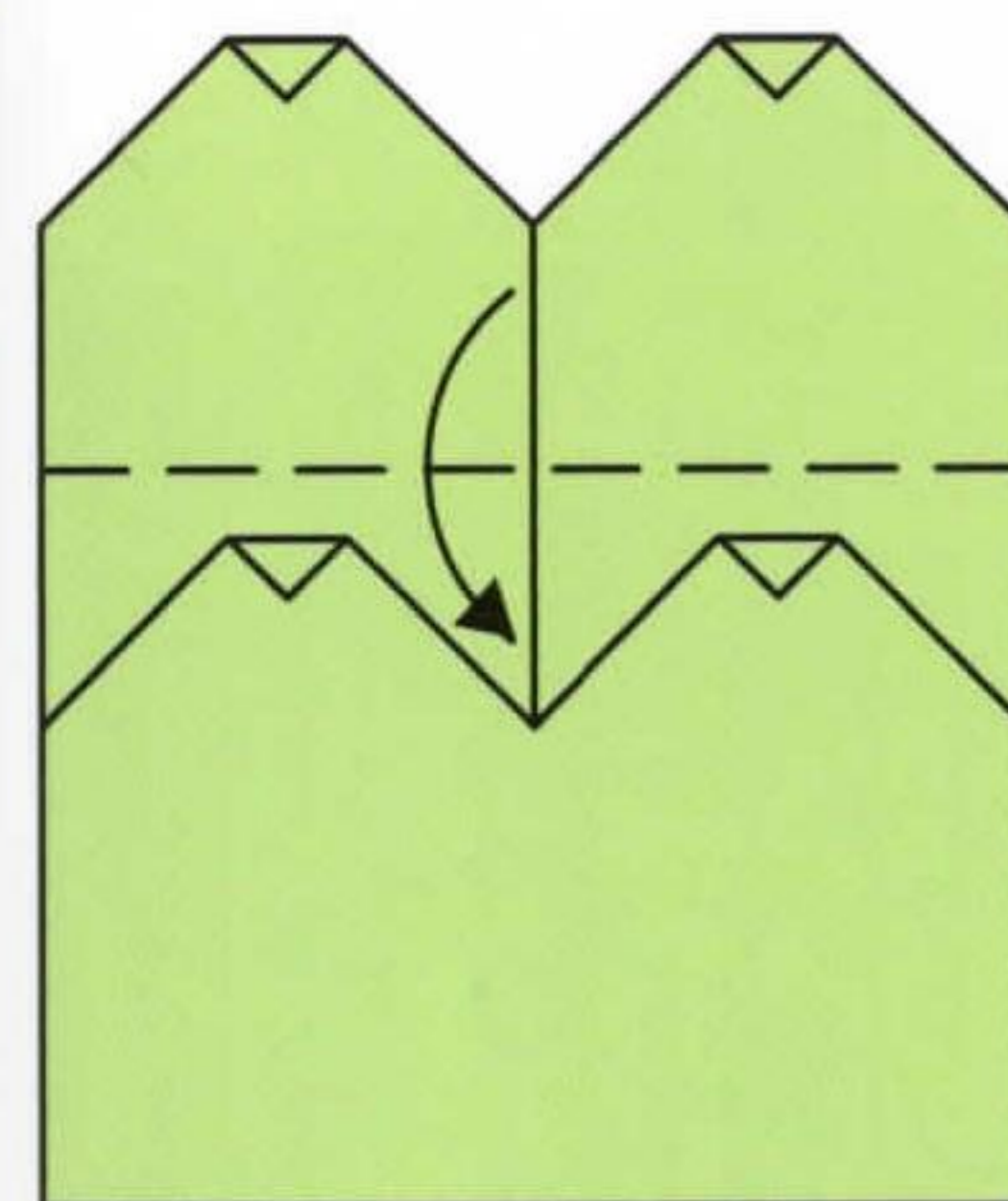

16. Valley fold

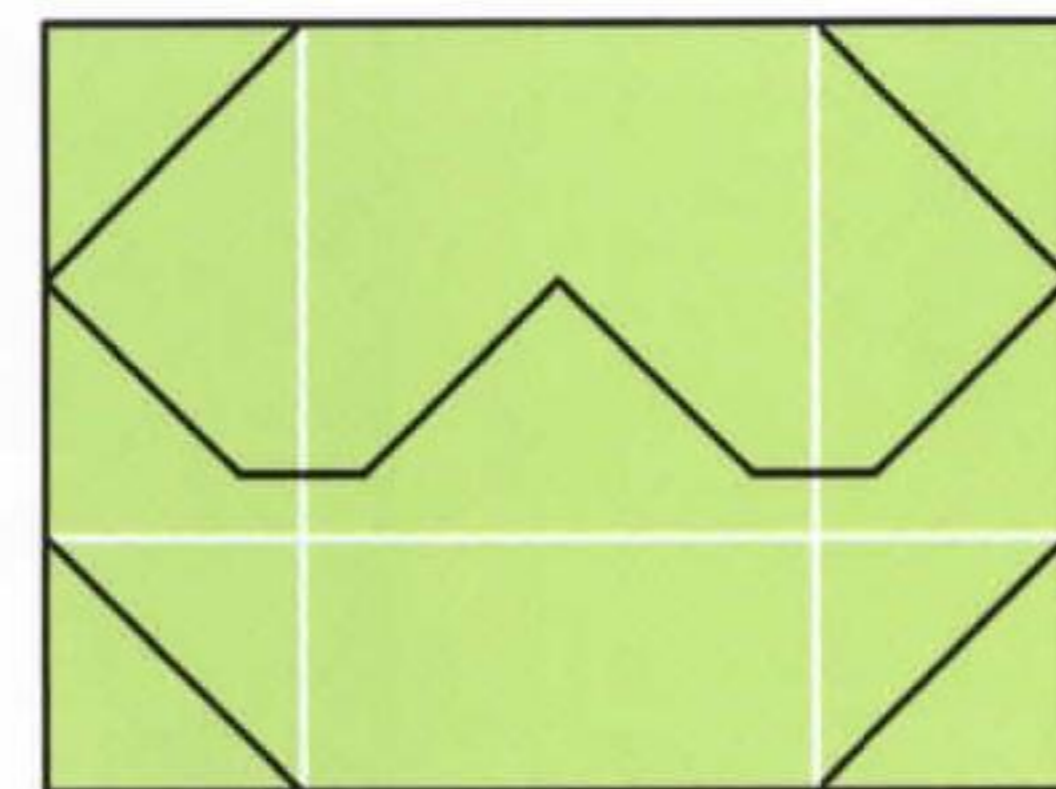

17. Inside reverse folds

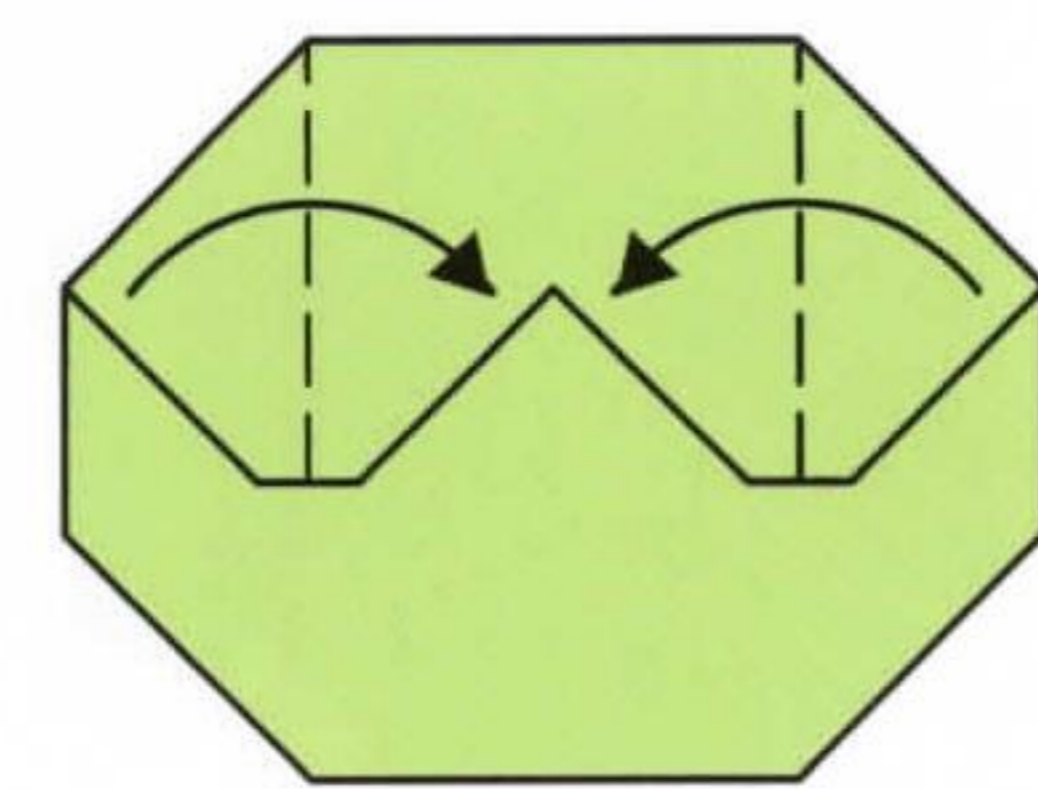

18. Valley folds

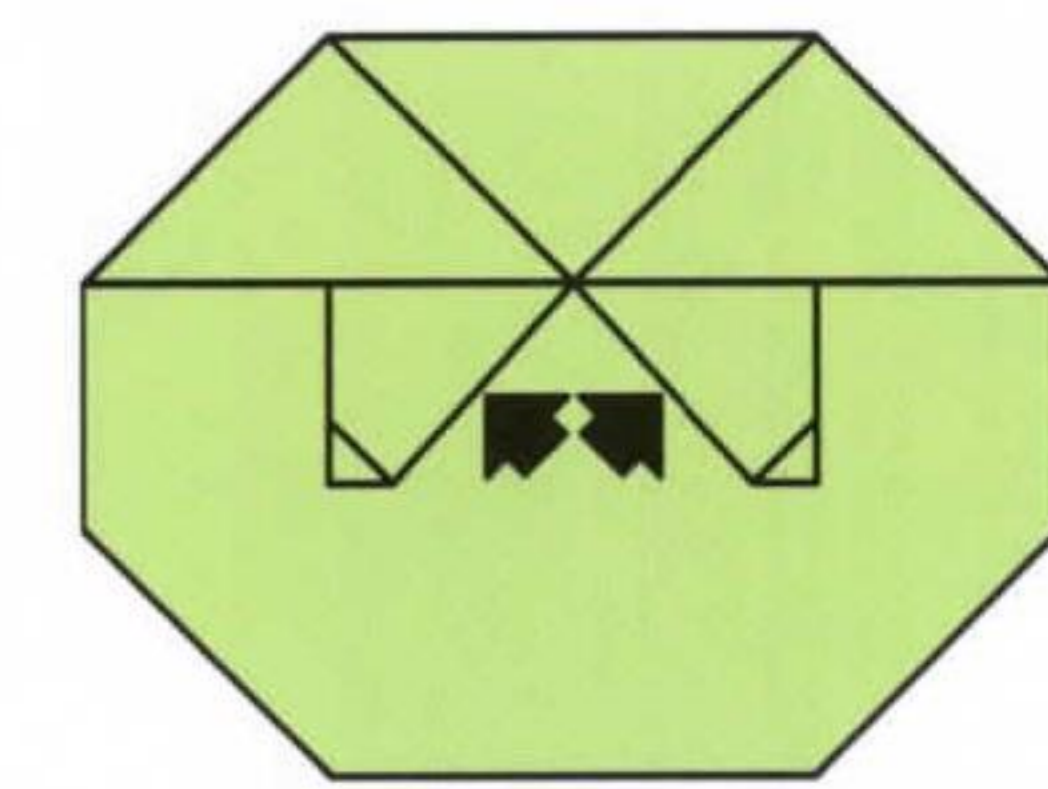

19. Apply glue

chair

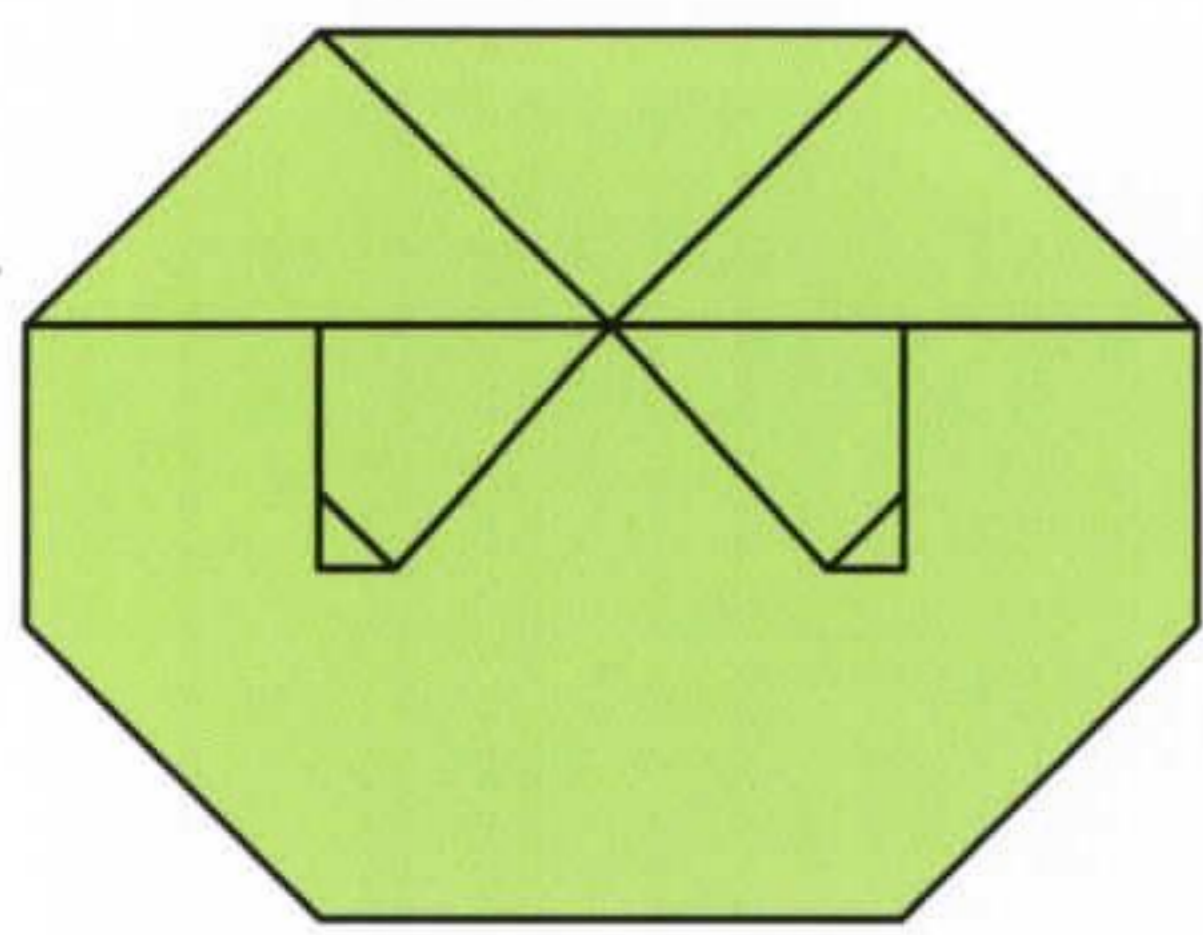

20. Hide behind layers

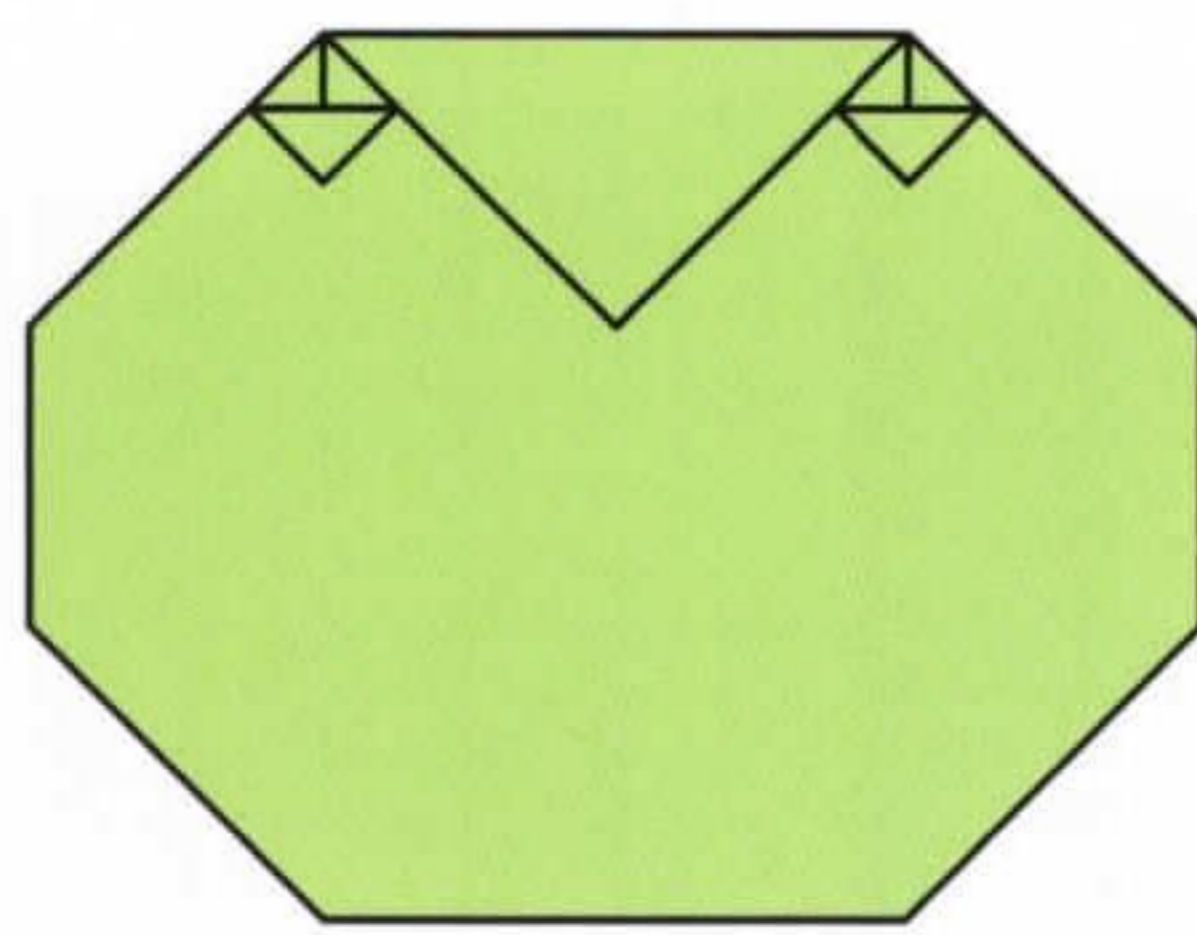

21. Turn over

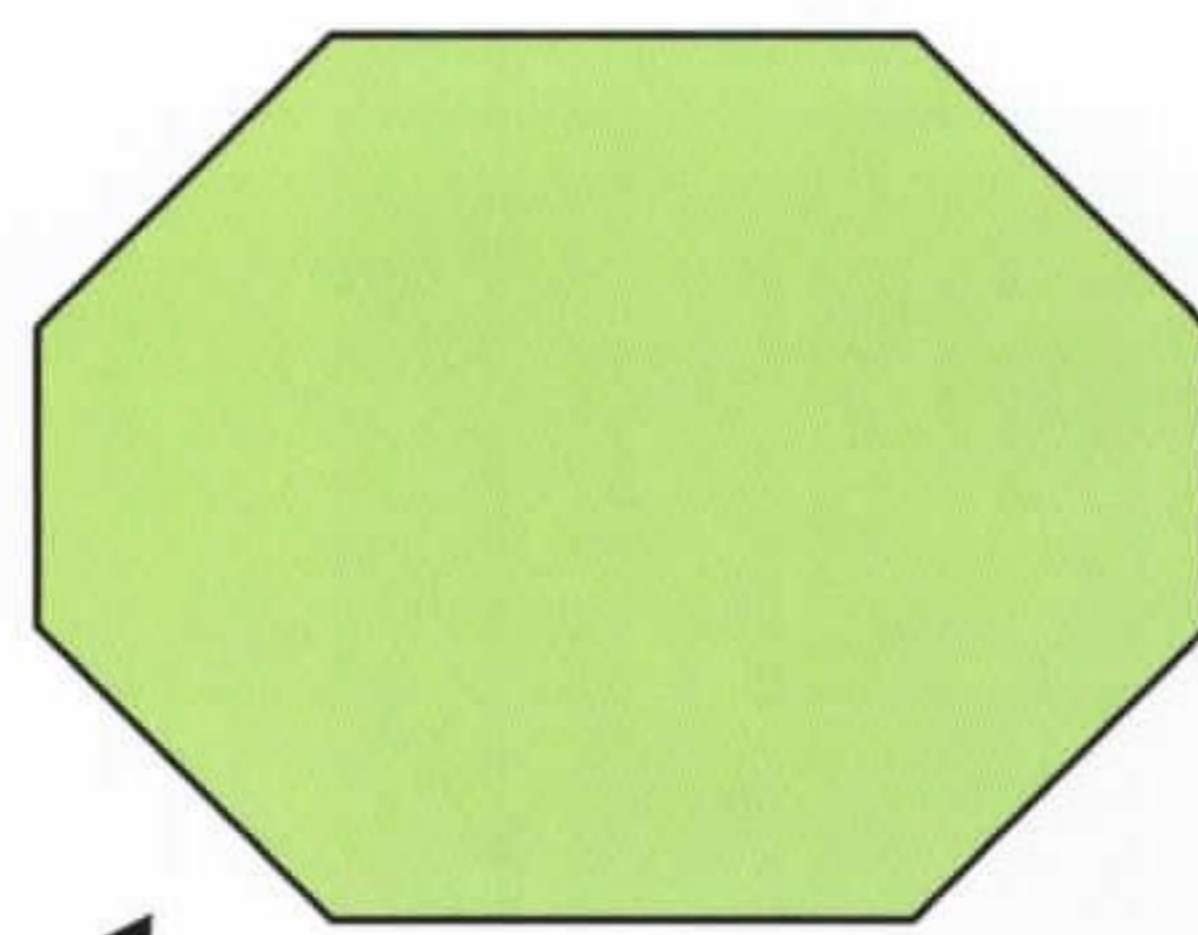

22. Rotate

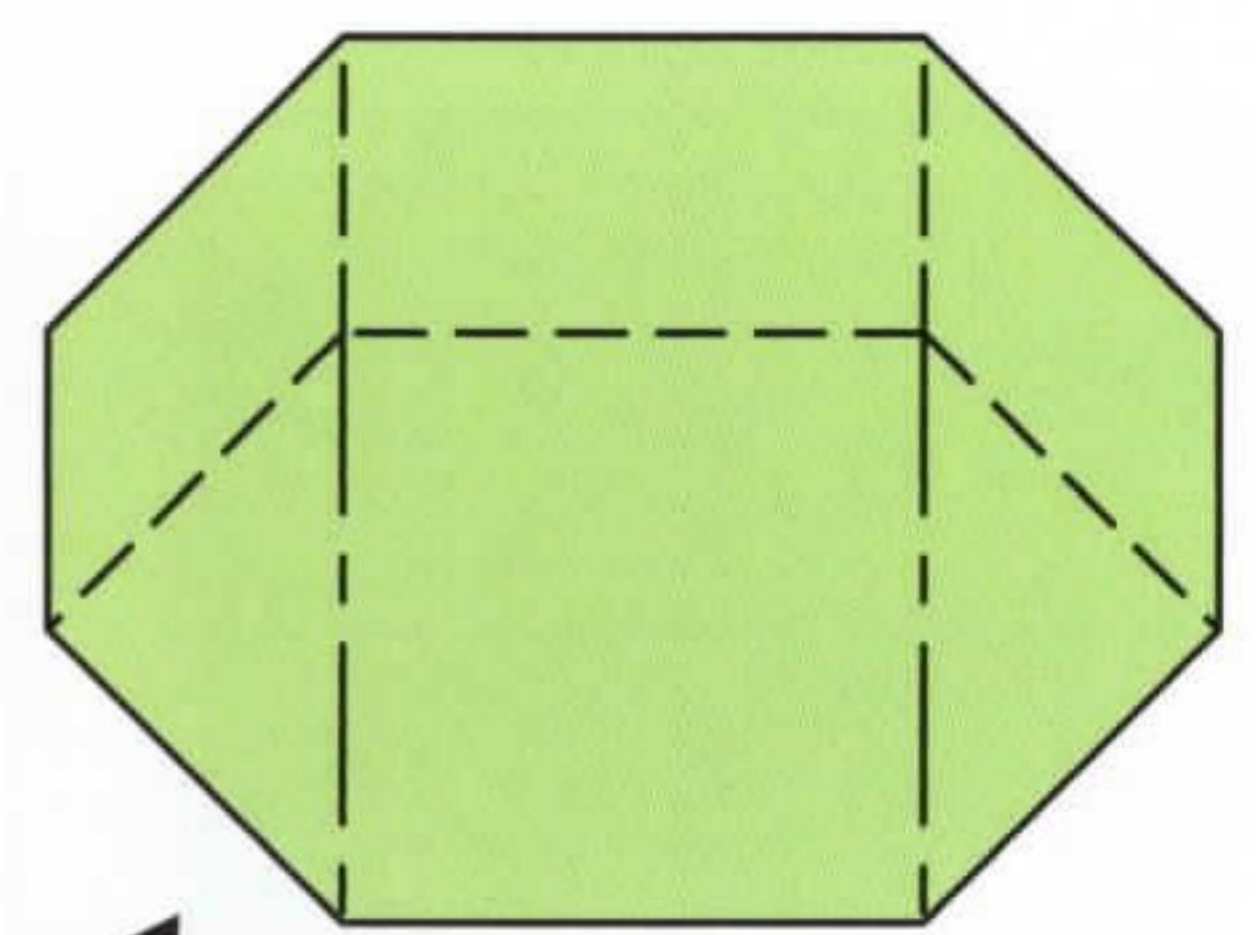

23. Crimp folds

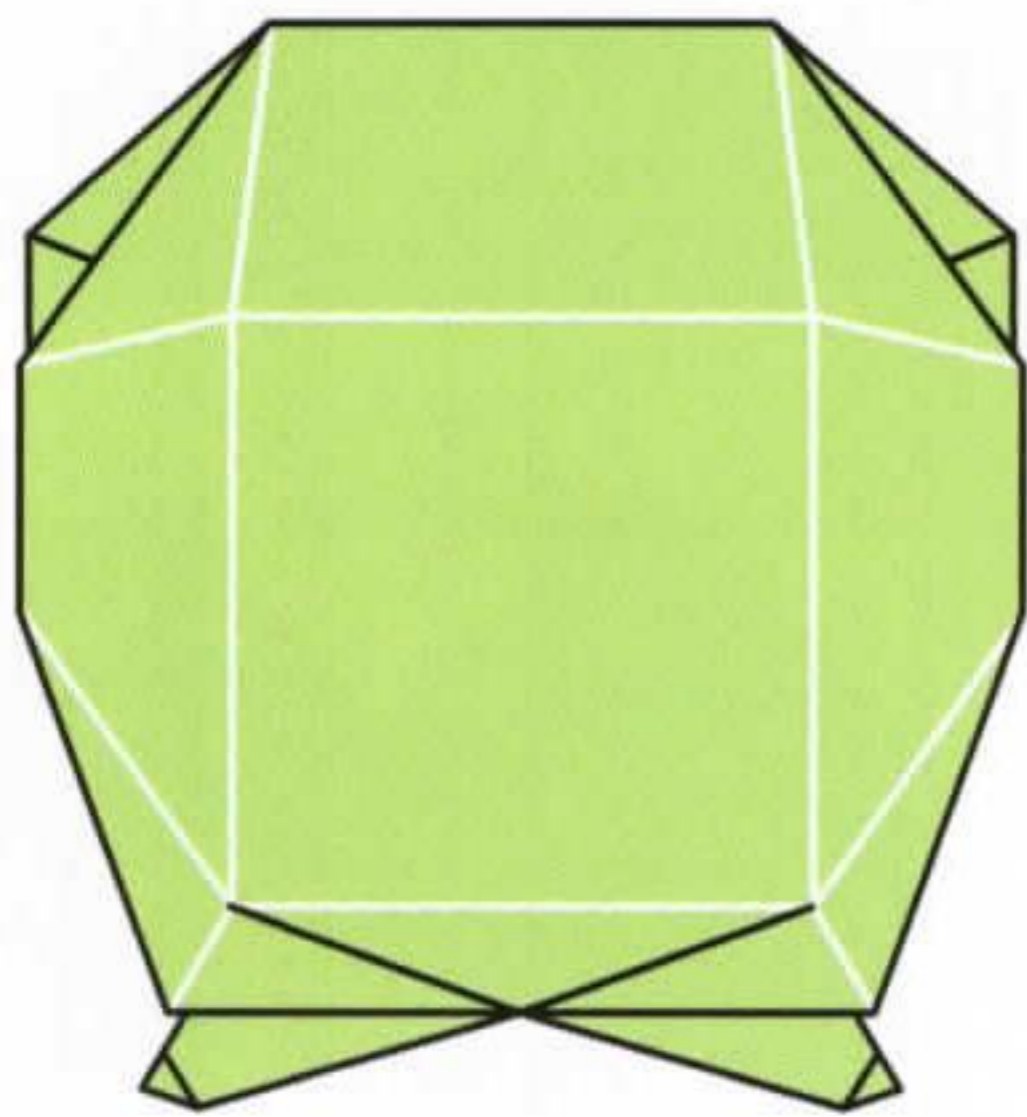

24. Before complete

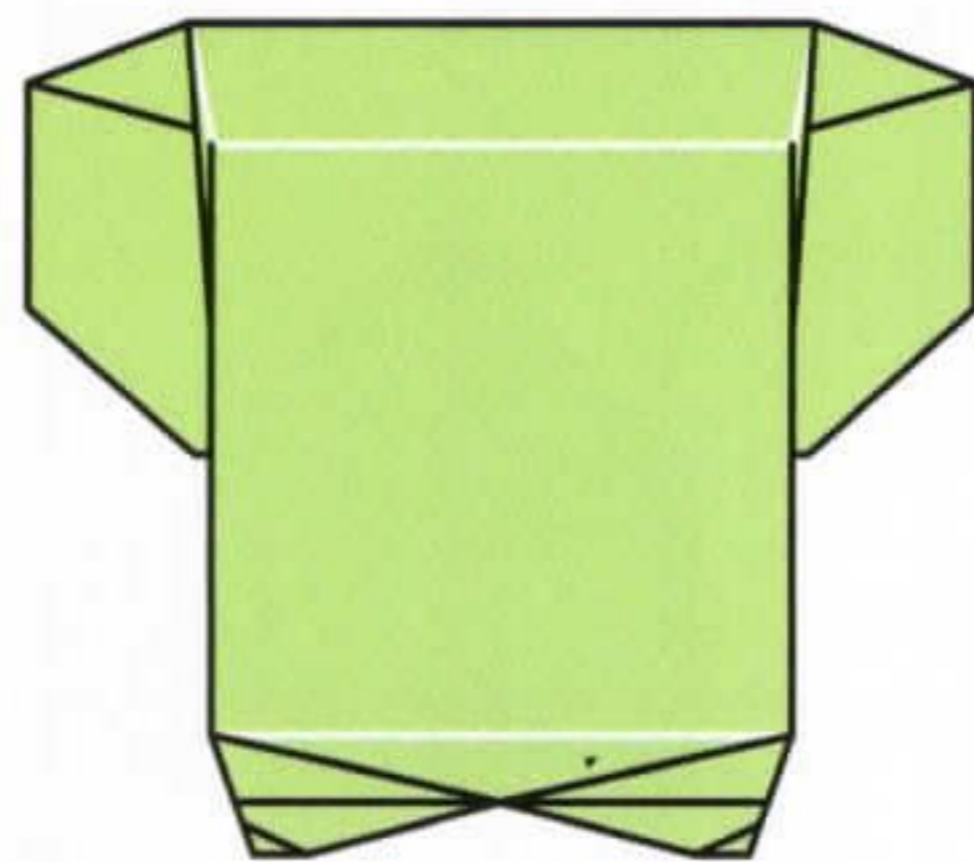

25. Rotate

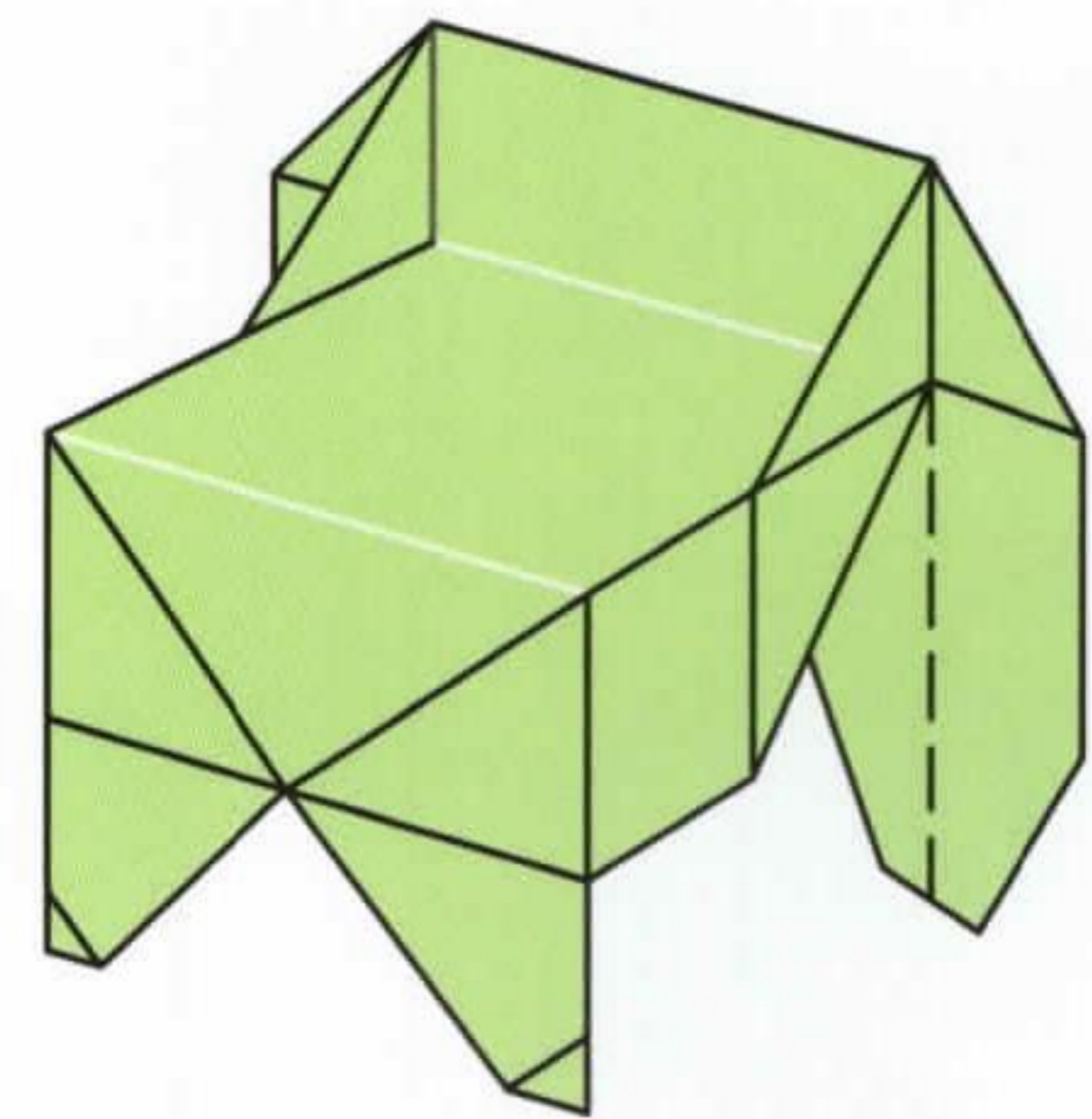

26. Valley fold both sides

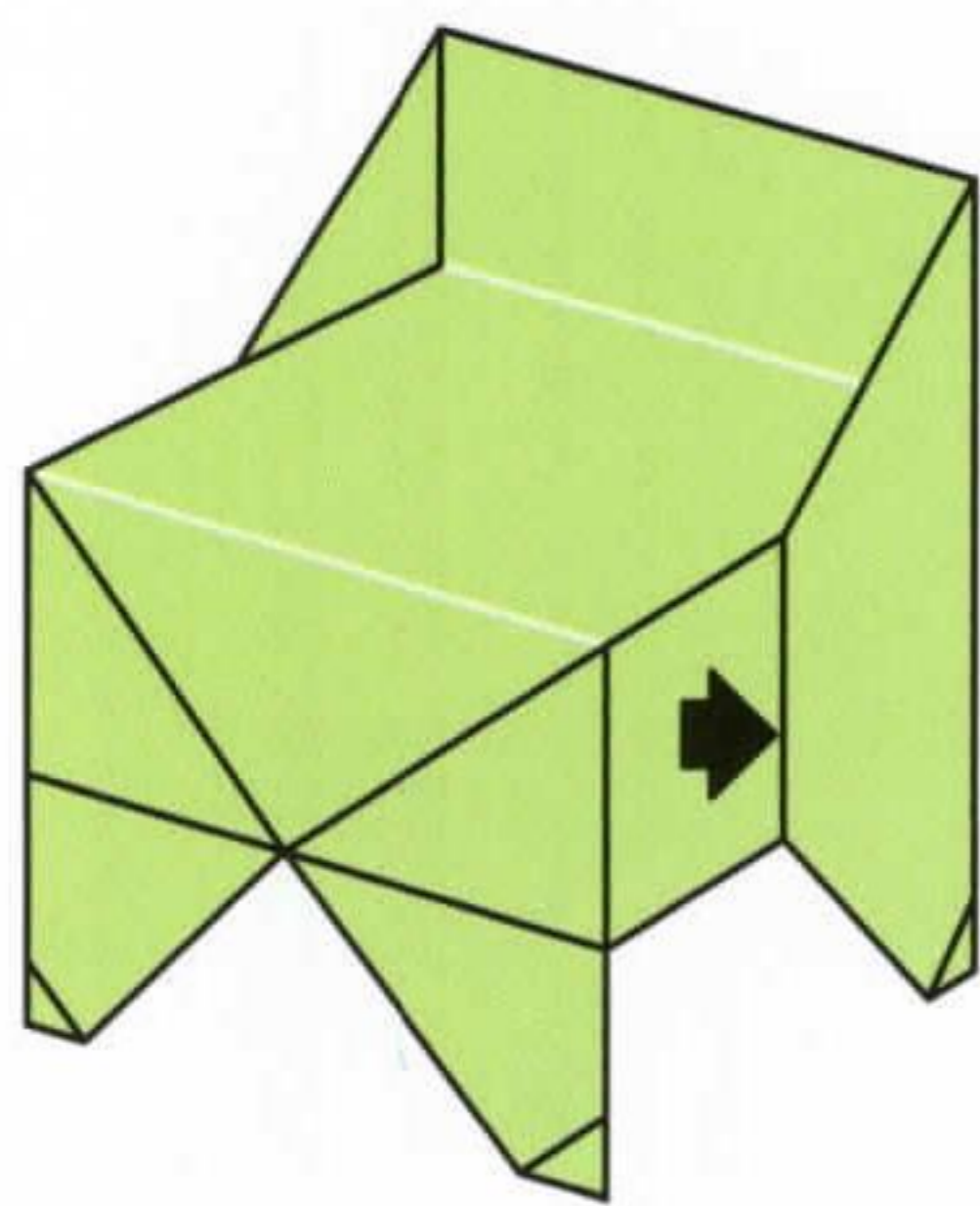

27. Apply glue to all sides

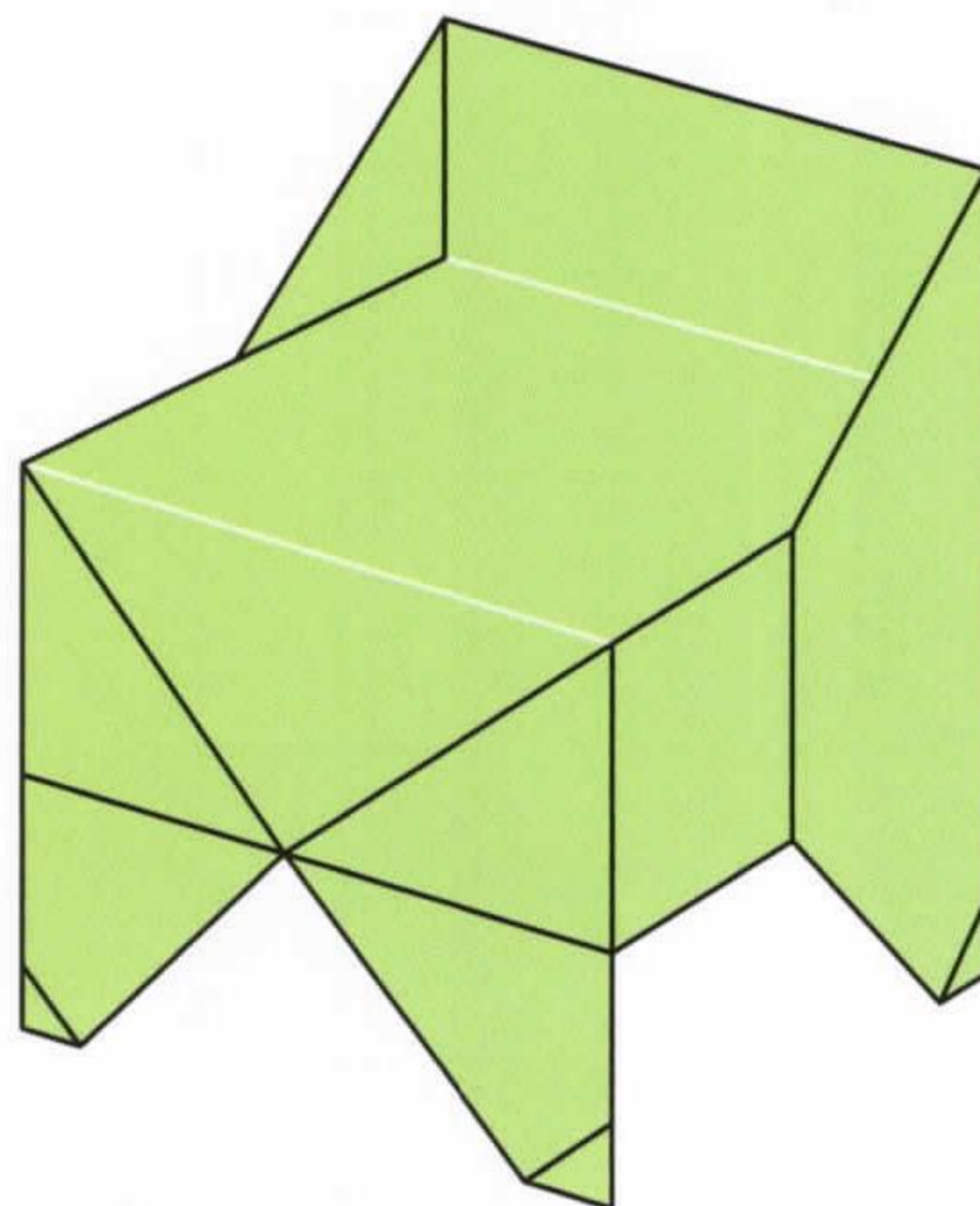

28. Completed CHAIR



► coffee table

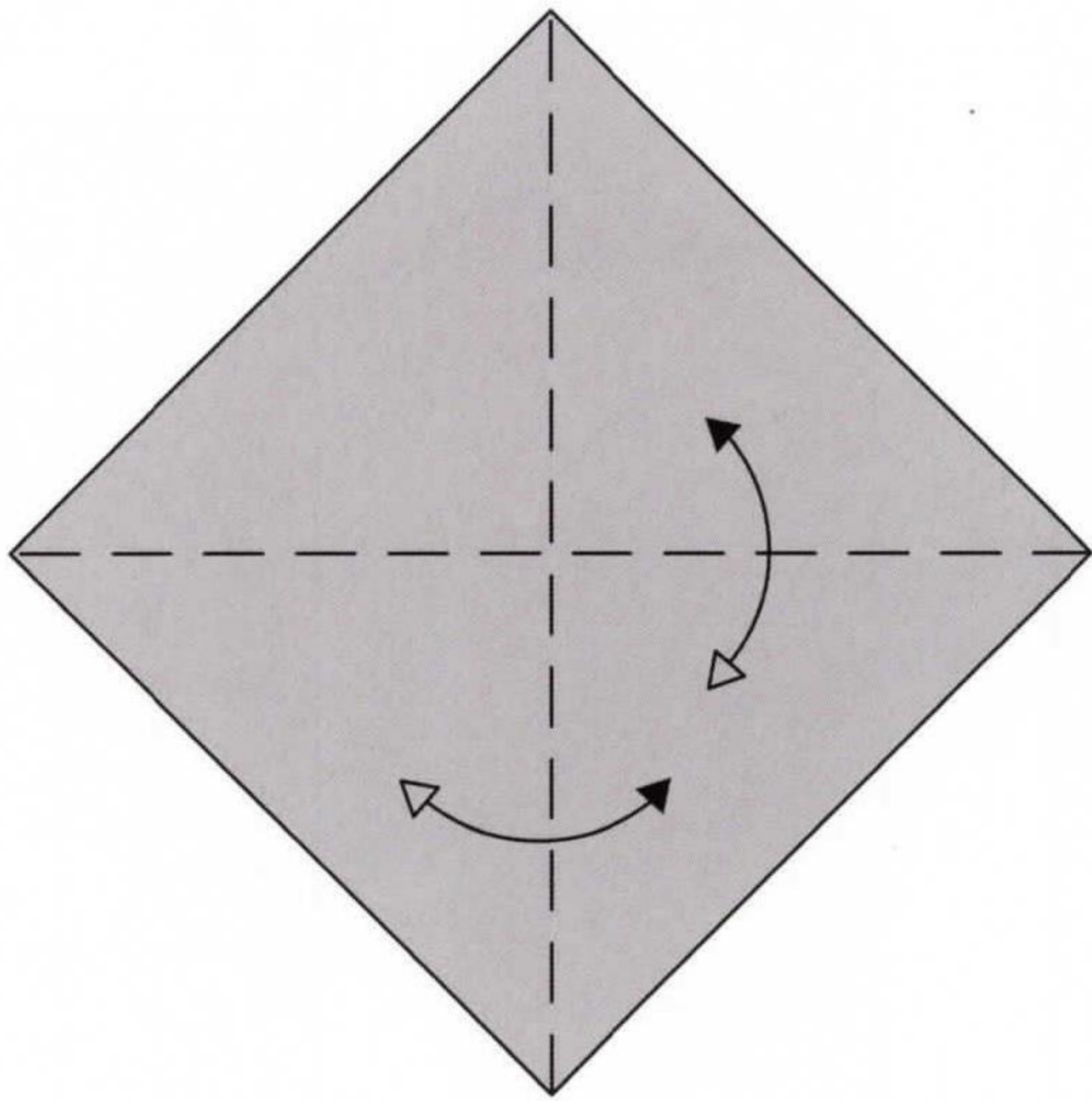

1. Valley folds and unfold

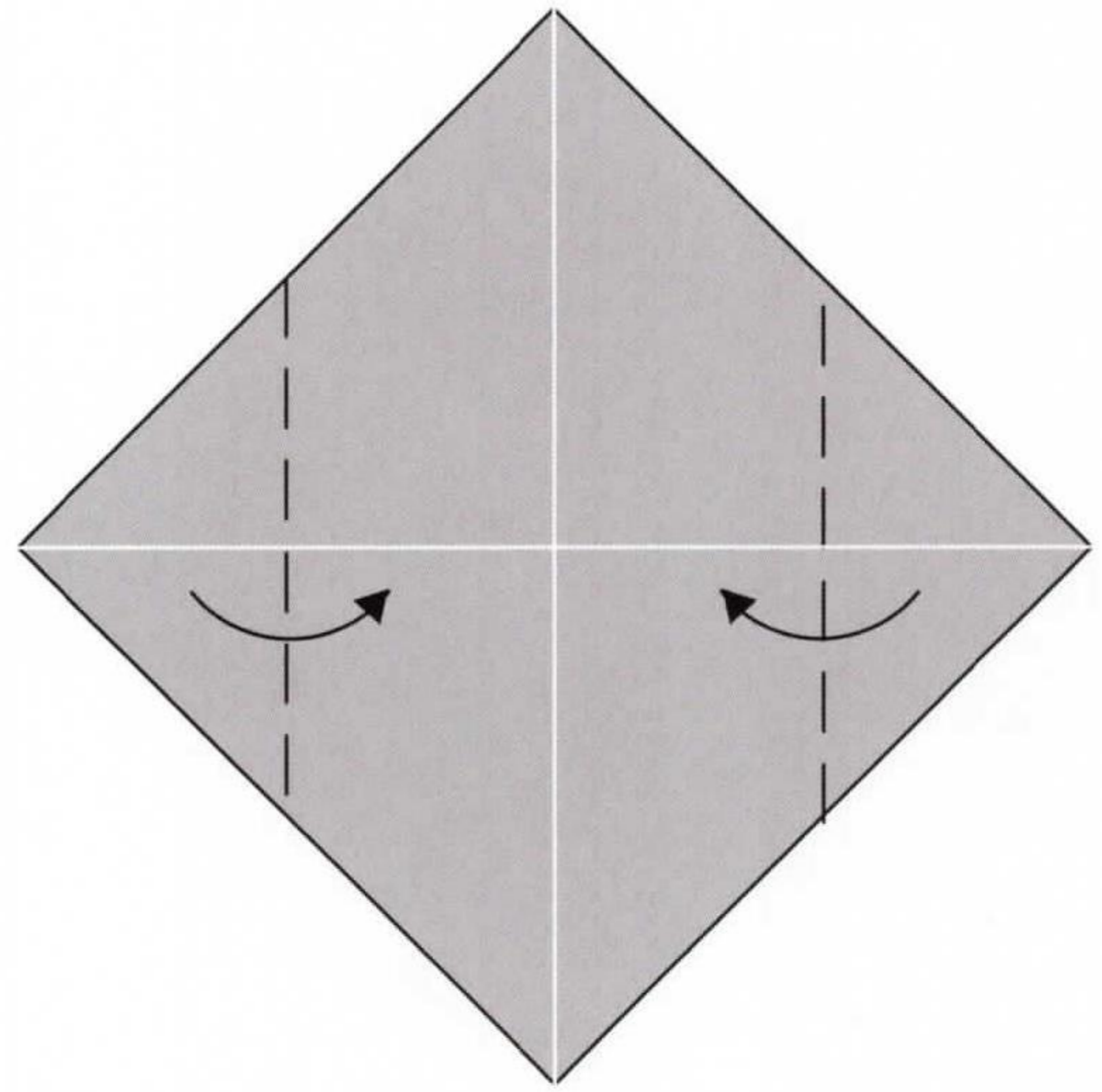

2. Valley folds

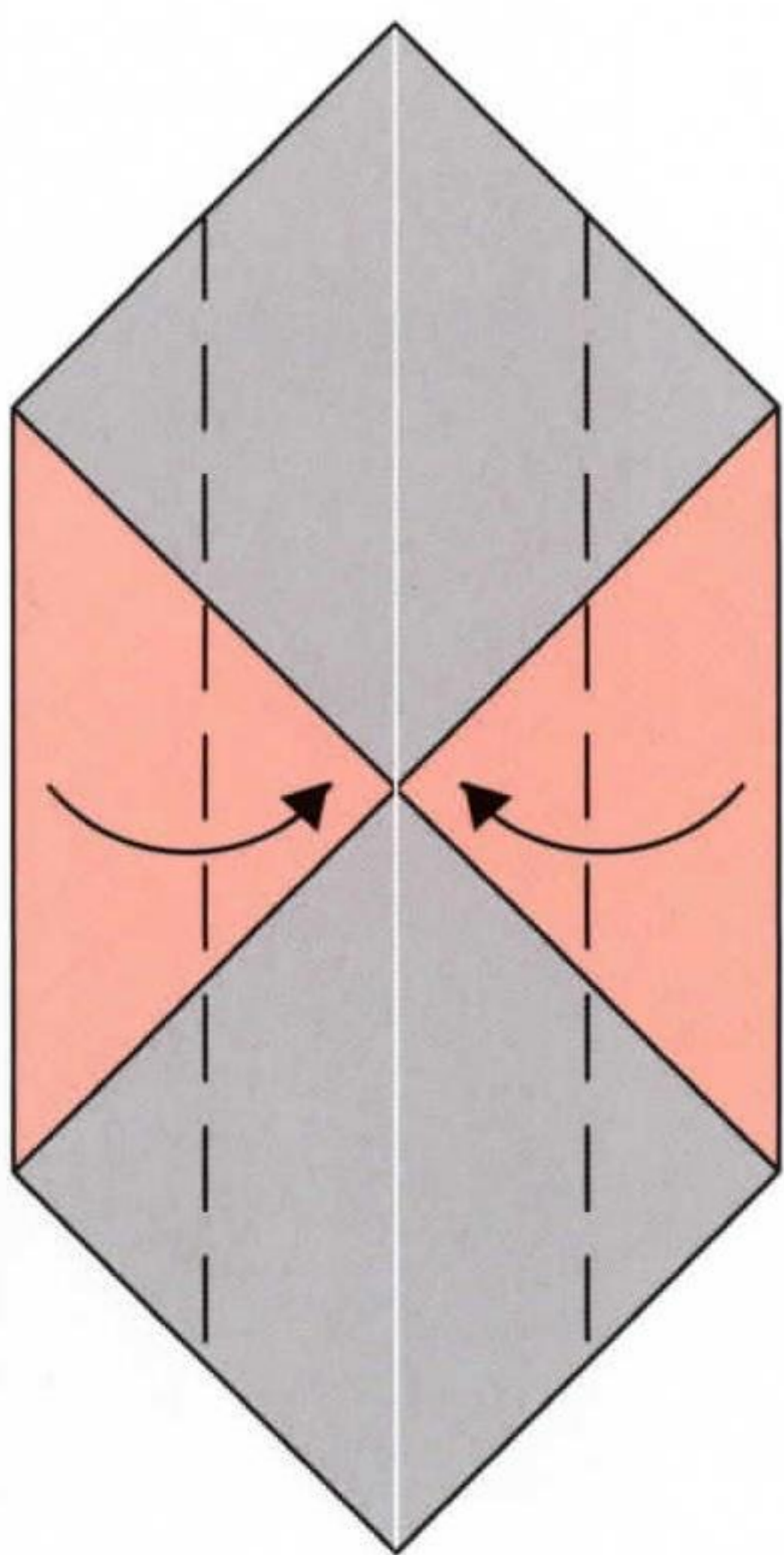

3. Valley folds

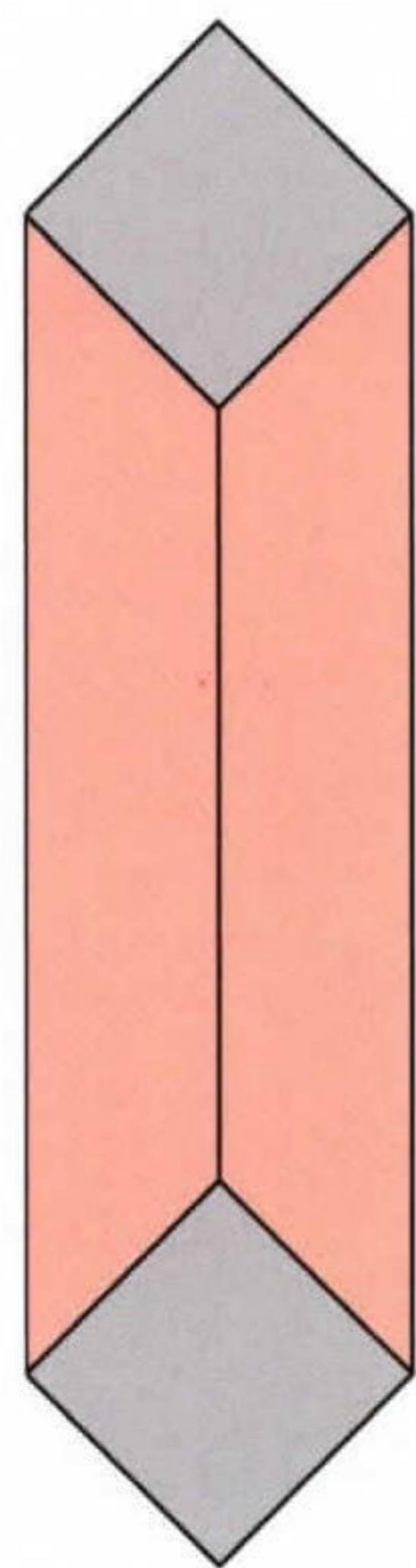

4. Scale-up

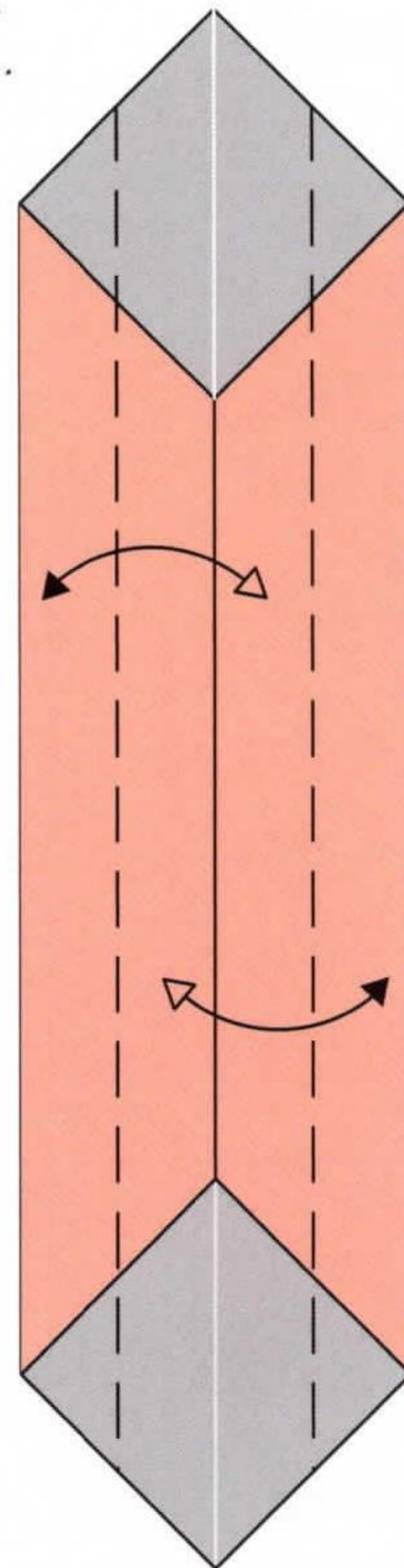

5. Fold and unfold

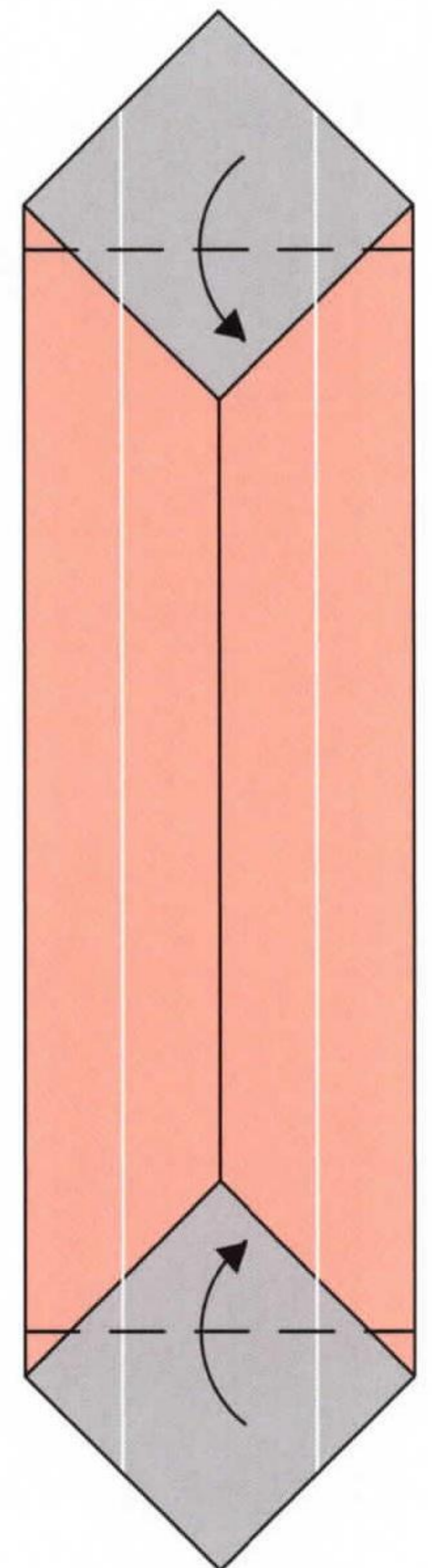

6. Valley folds

coffee table

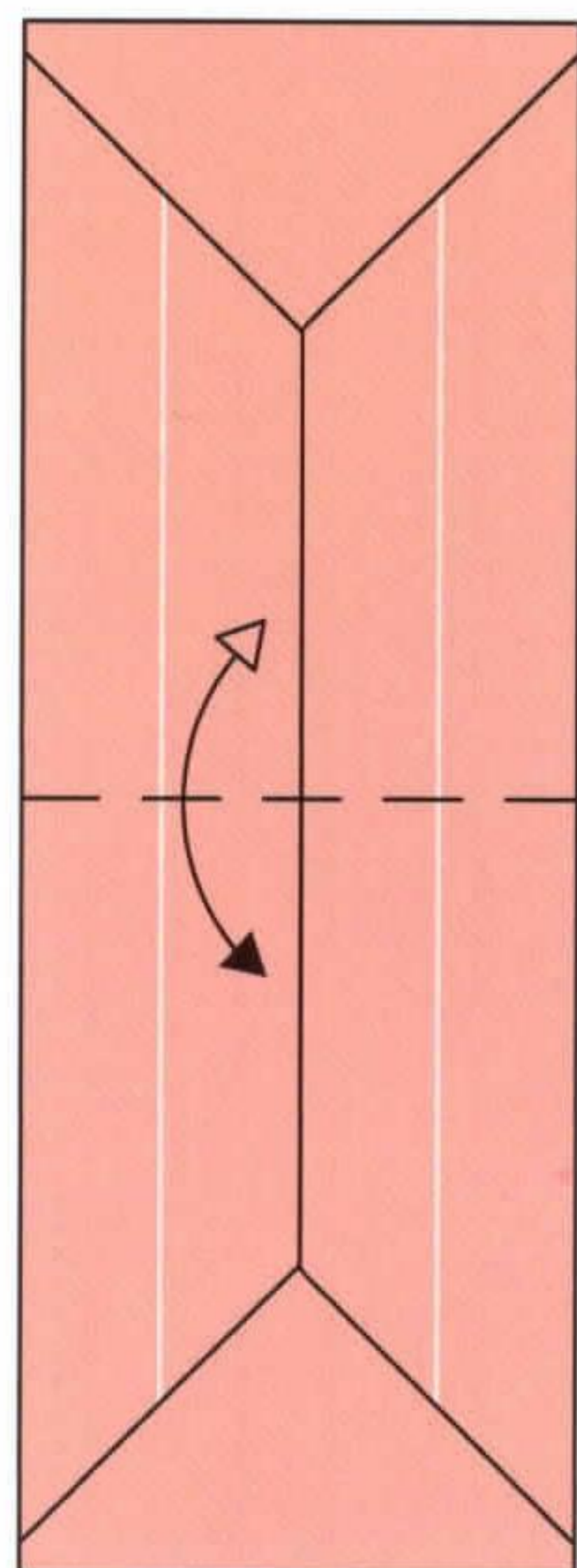

7. Valley fold and unfold

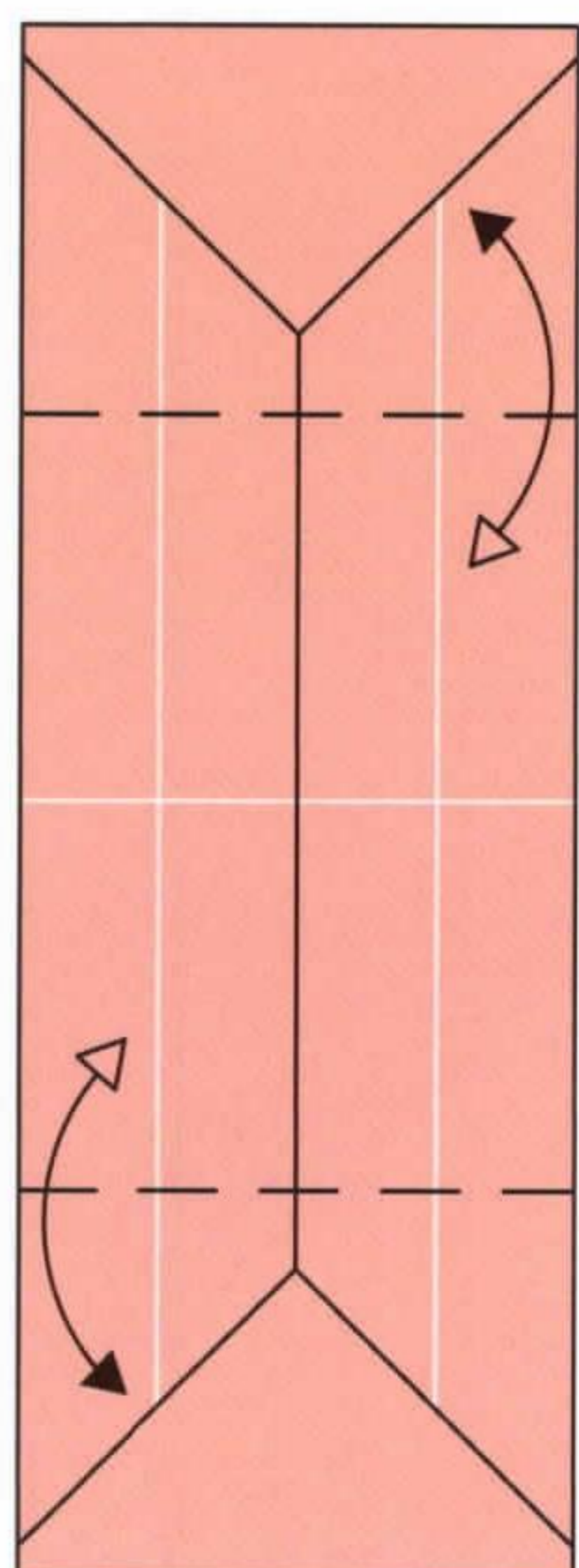

8. Repeat

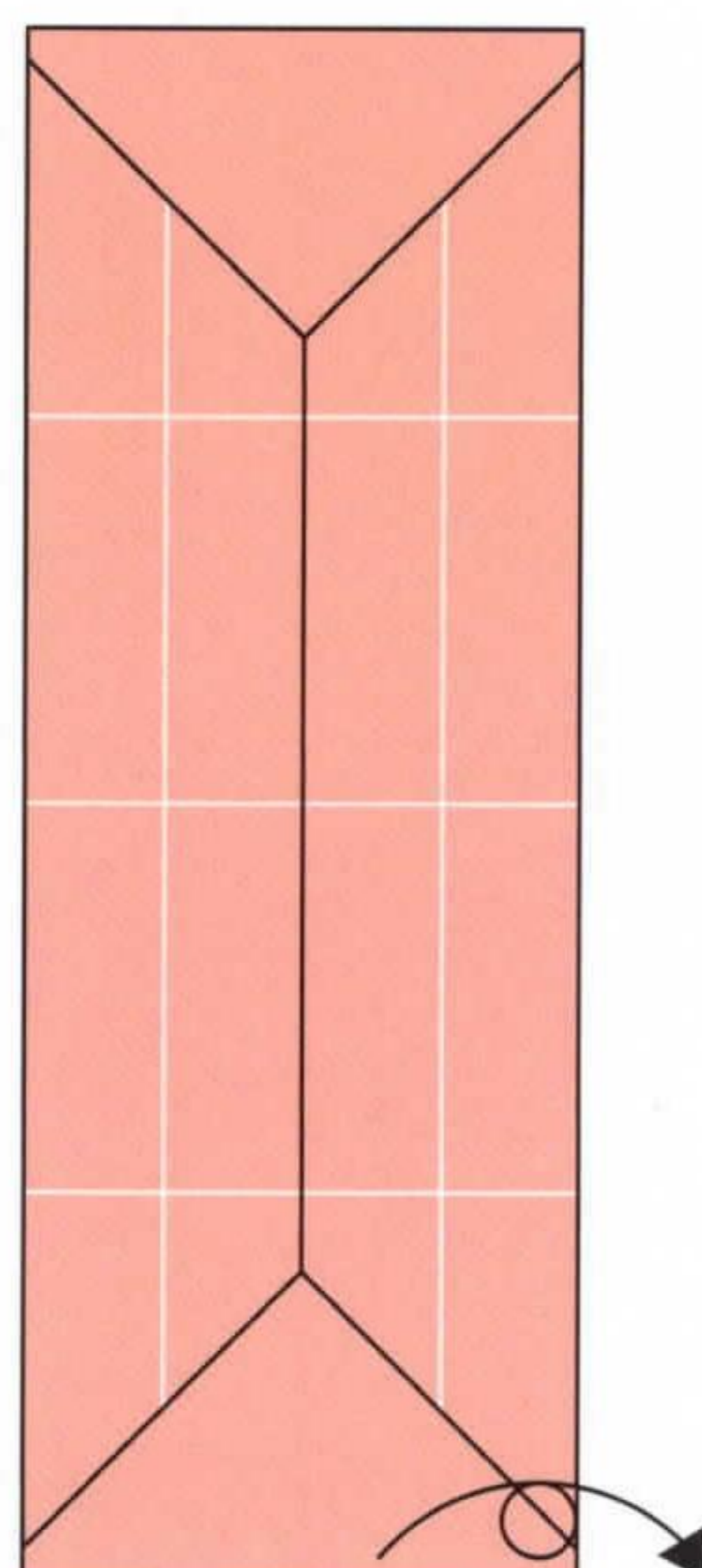

9. Turn over

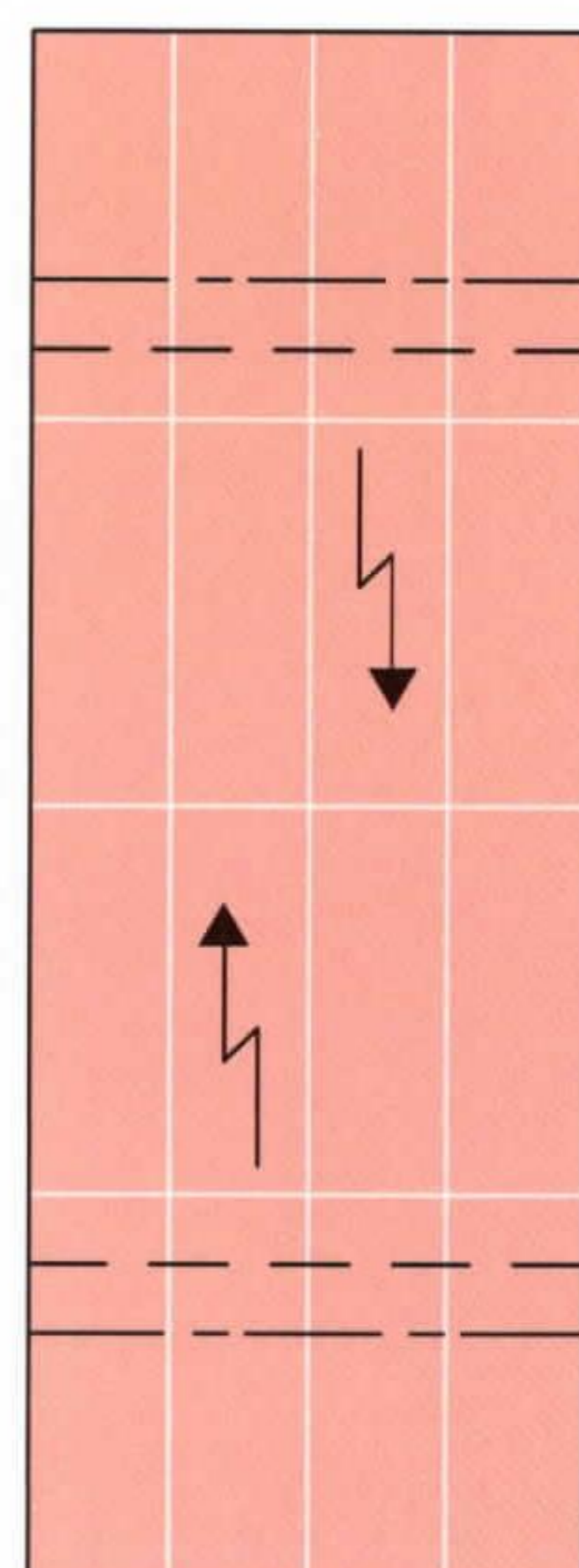

10. Pleat folds

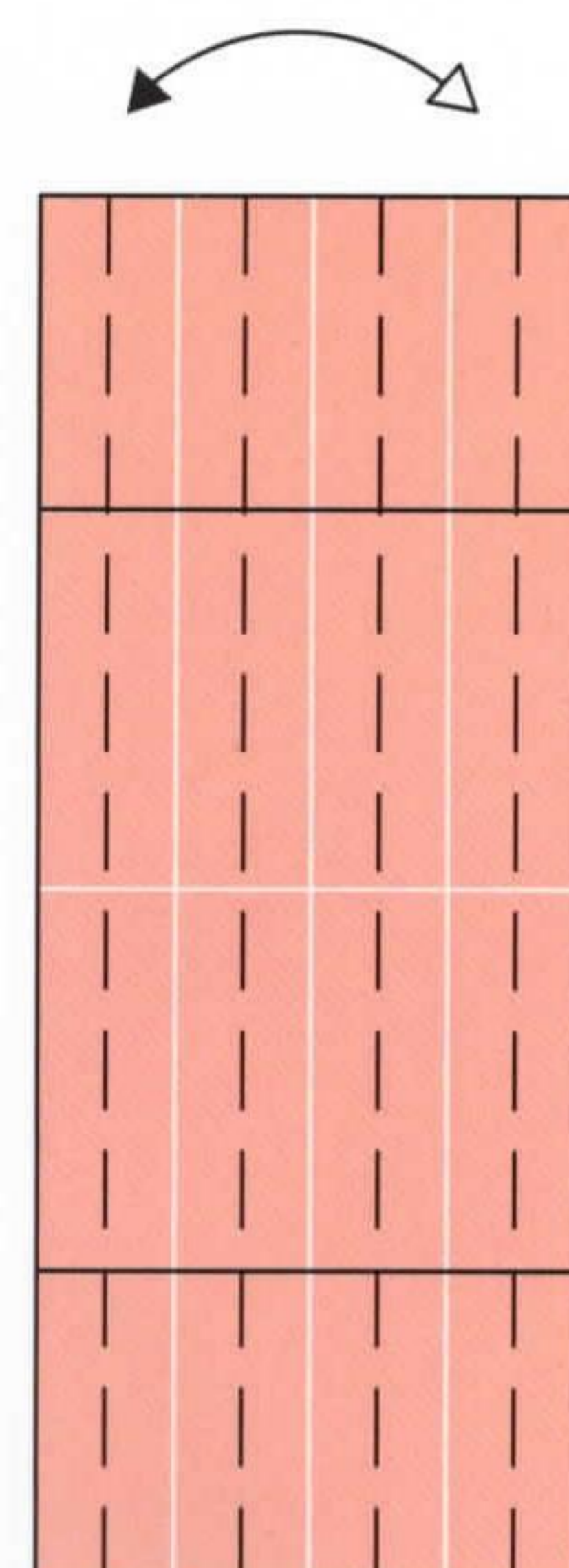

11. Valley folds and unfold

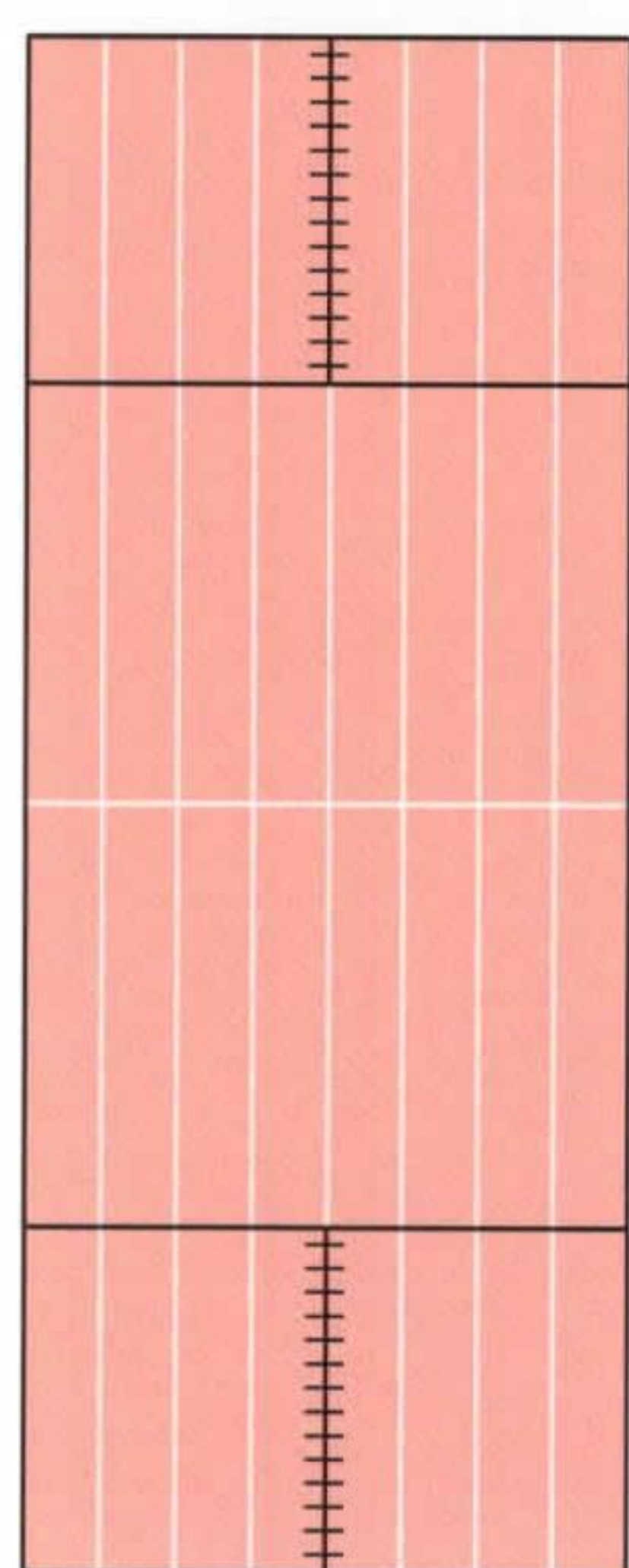

12. Cuts as shown

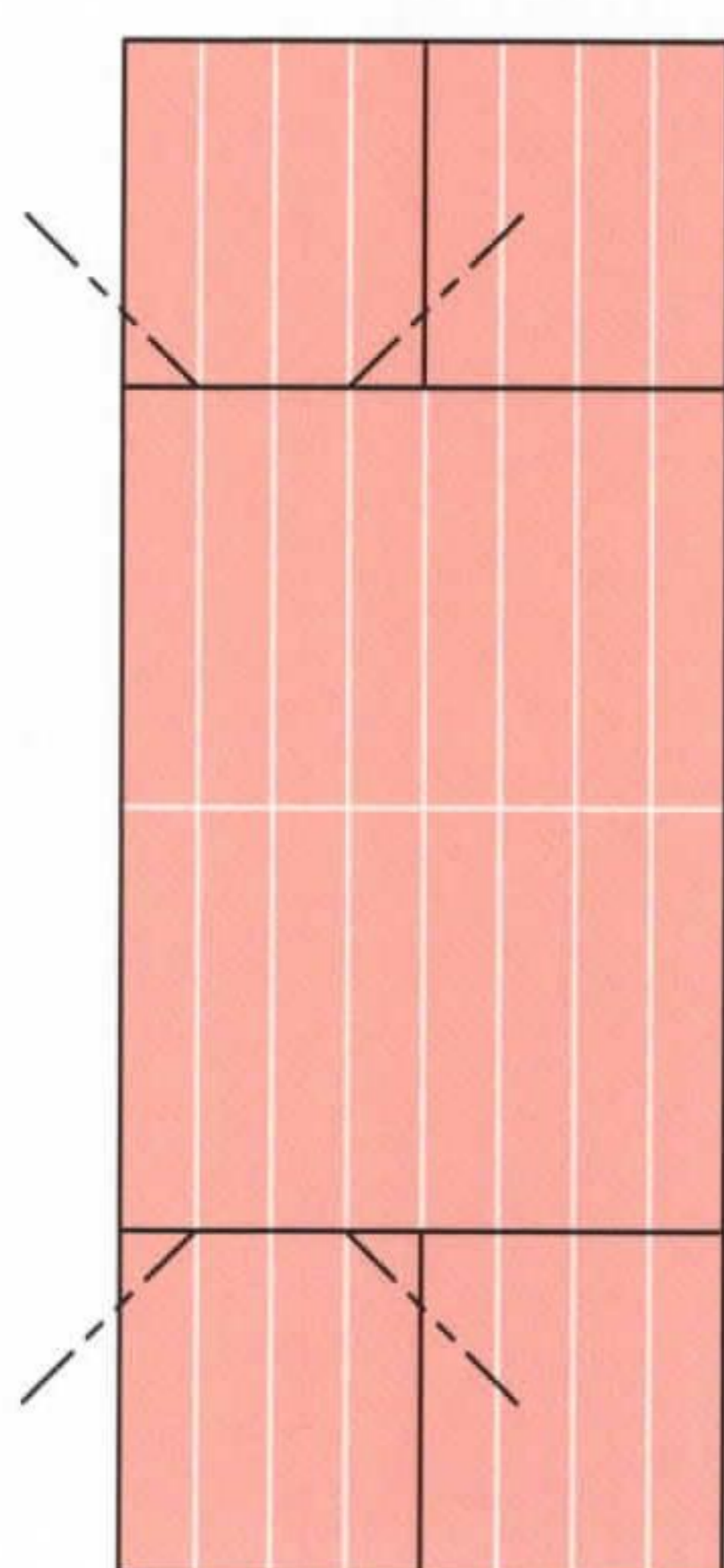

13. Inside reverse folds

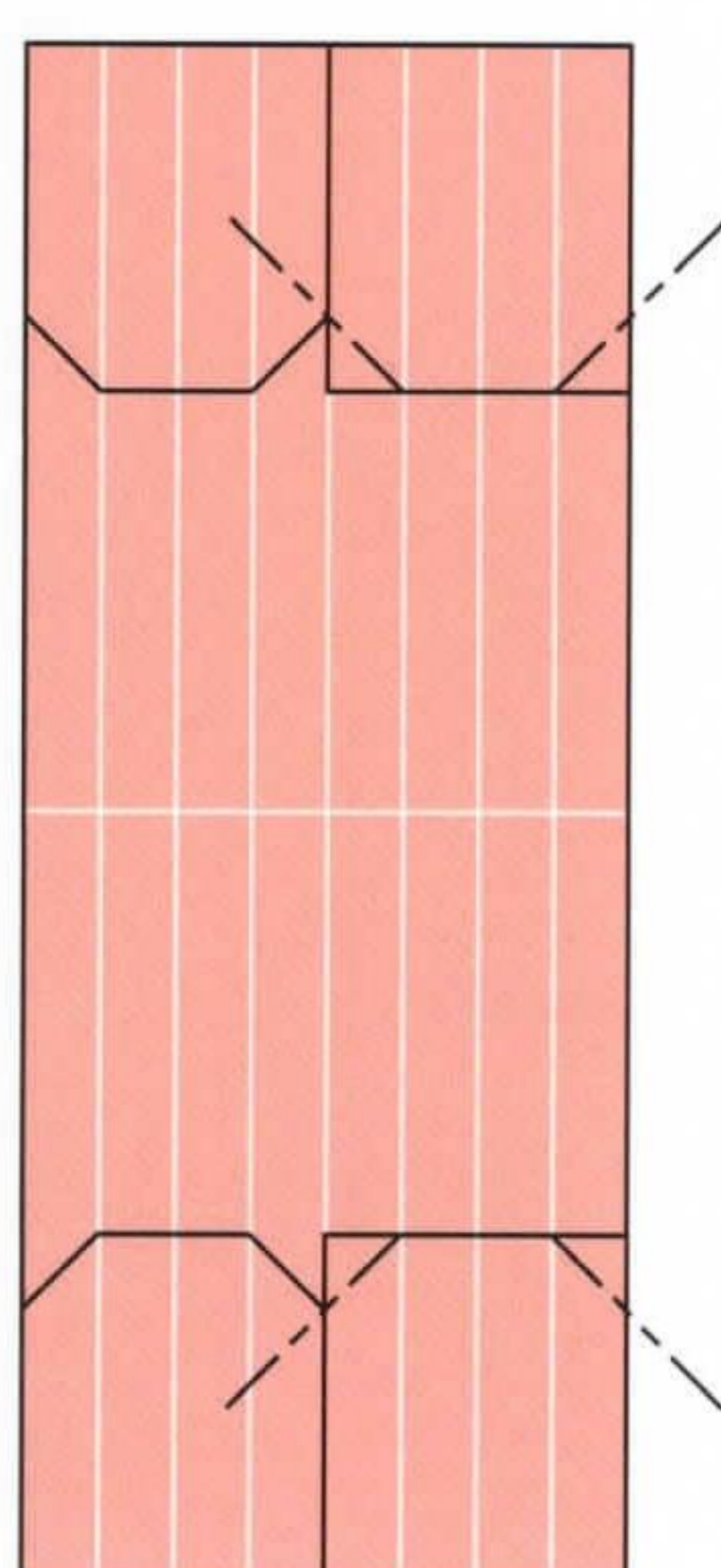

14. Repeat

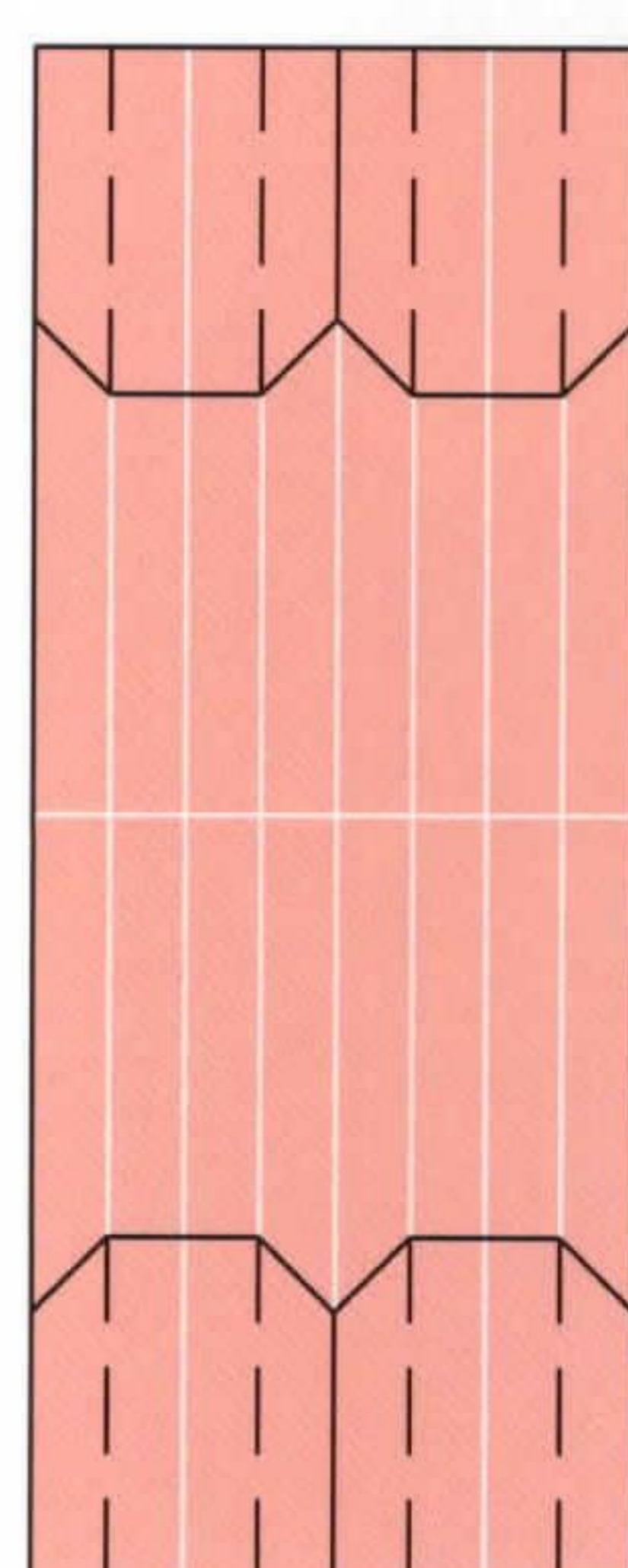

15. Valley folds

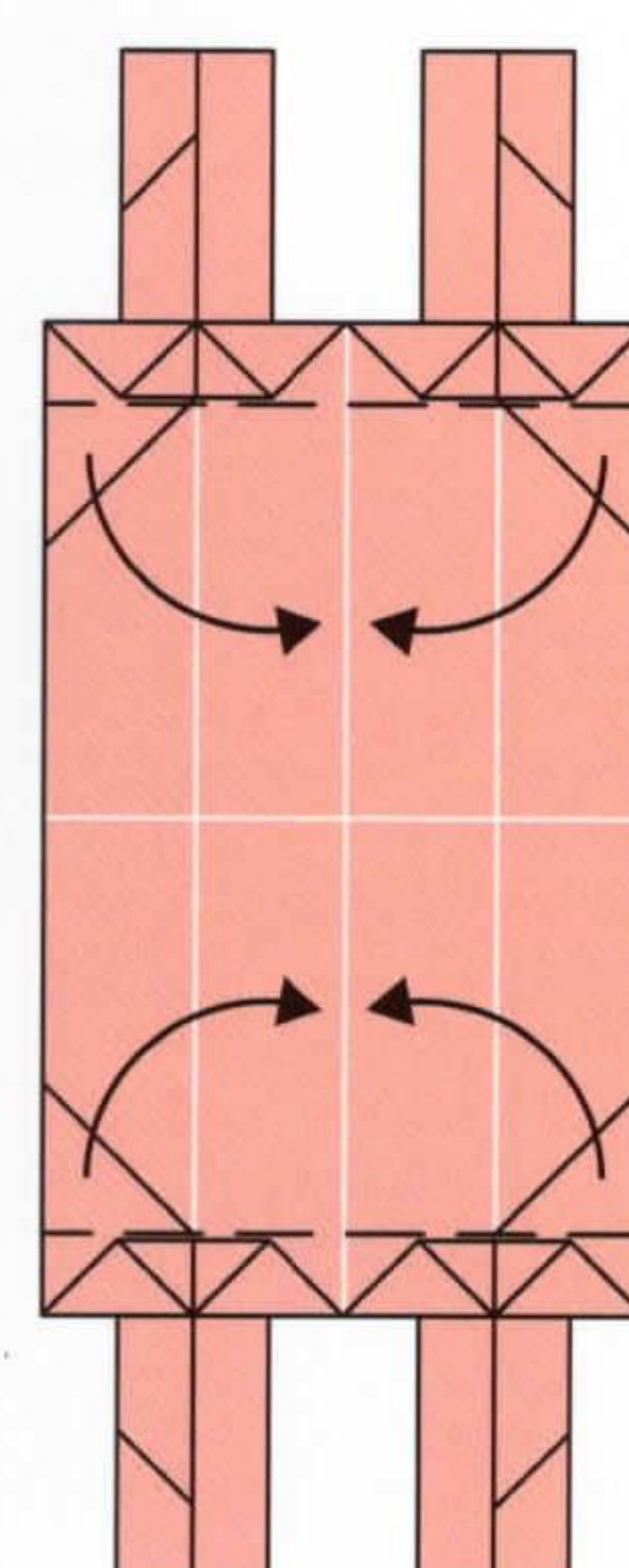

16. Valley folds and unfolds

coffee table

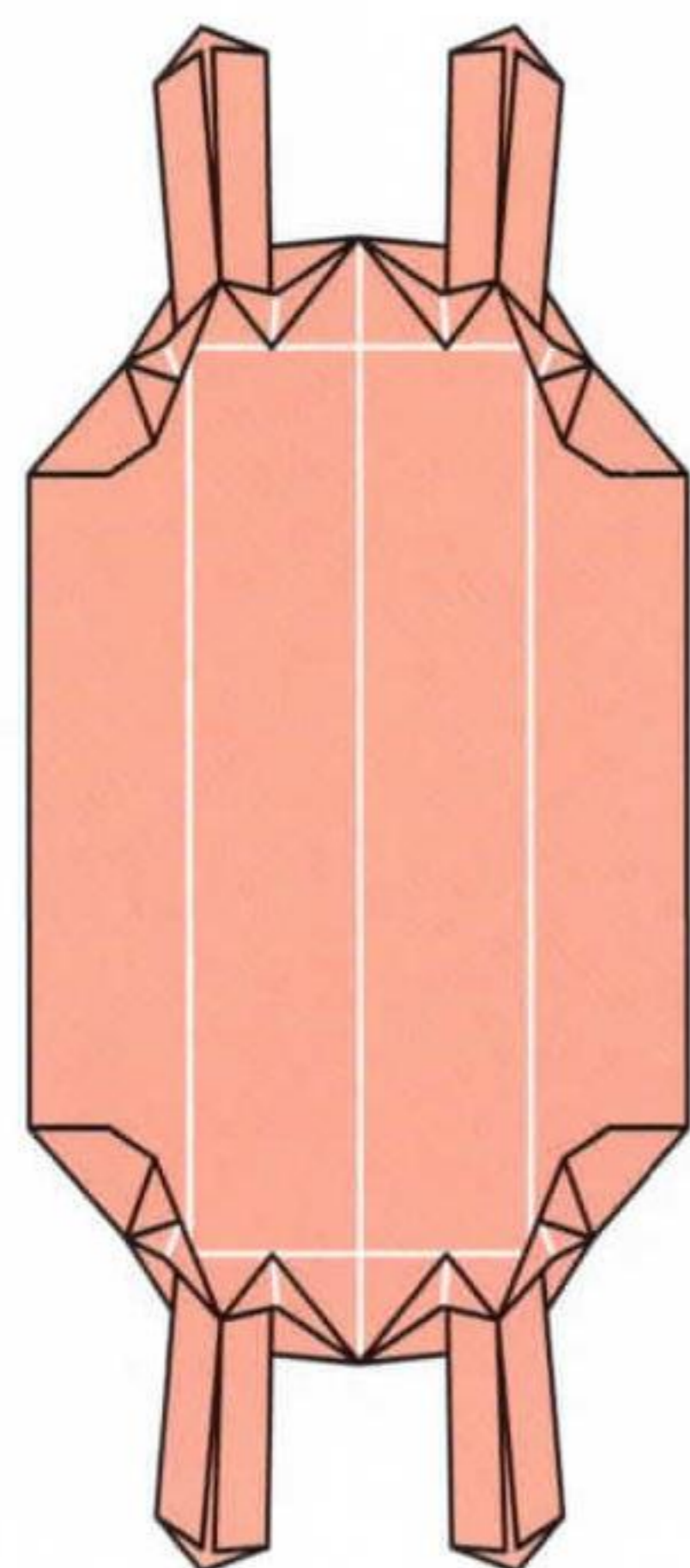

17. Before complete

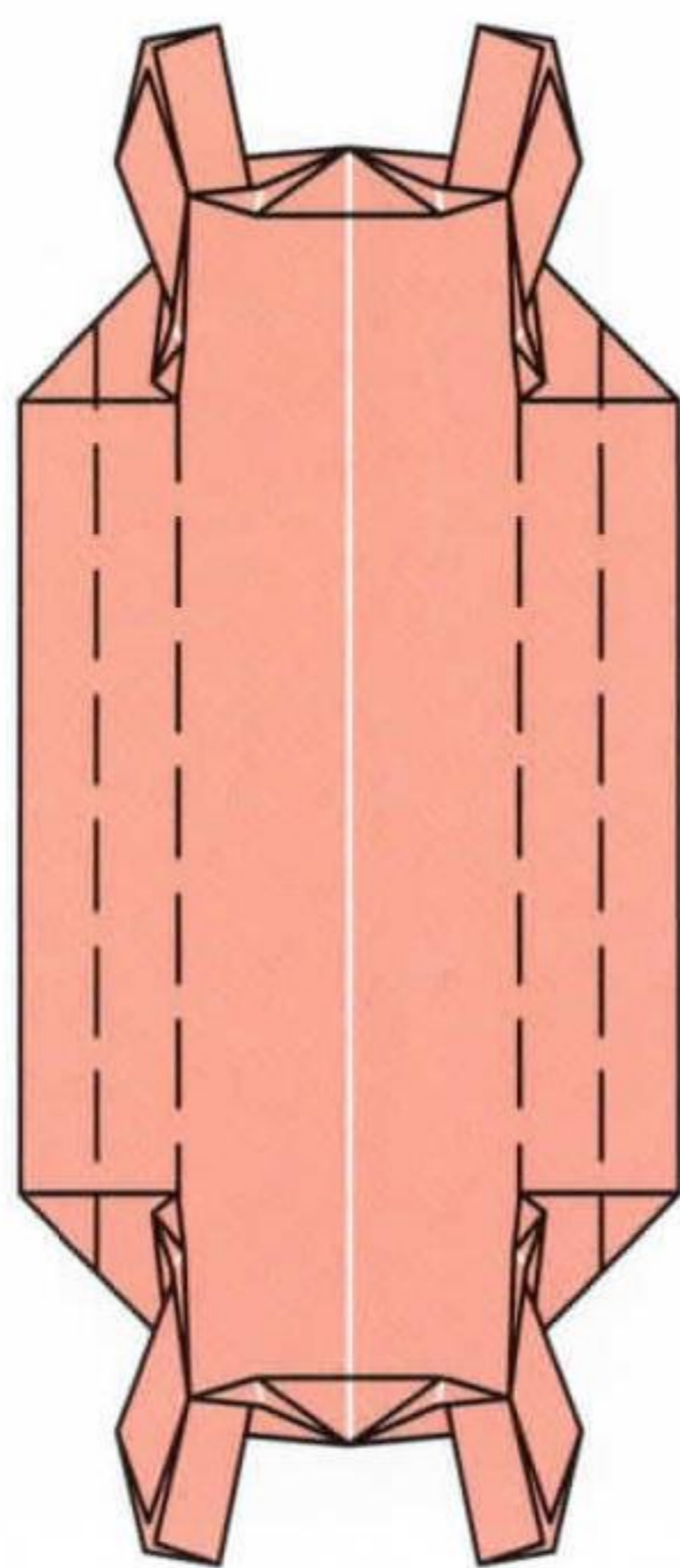

18. Valley fold twice to wrap around layers

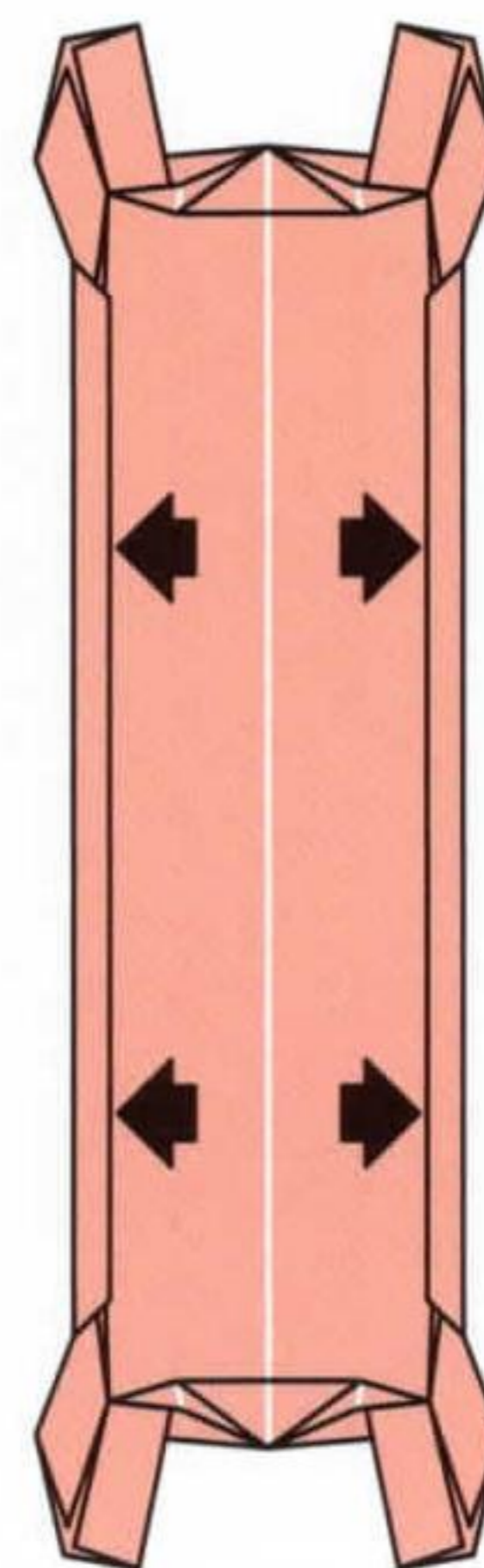

19. Add glue

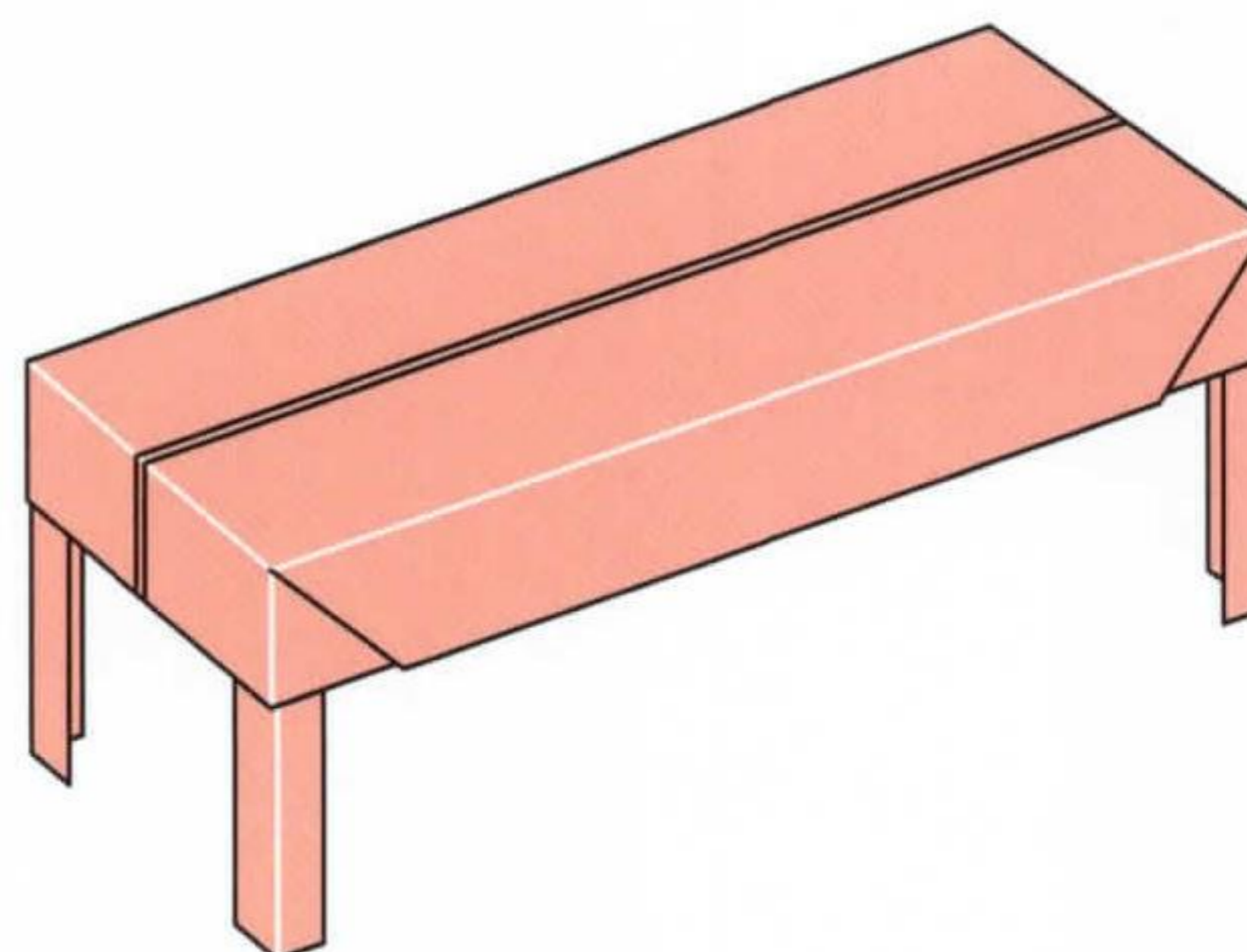

20. Completed COFFEE TABLE



► couch: part 1

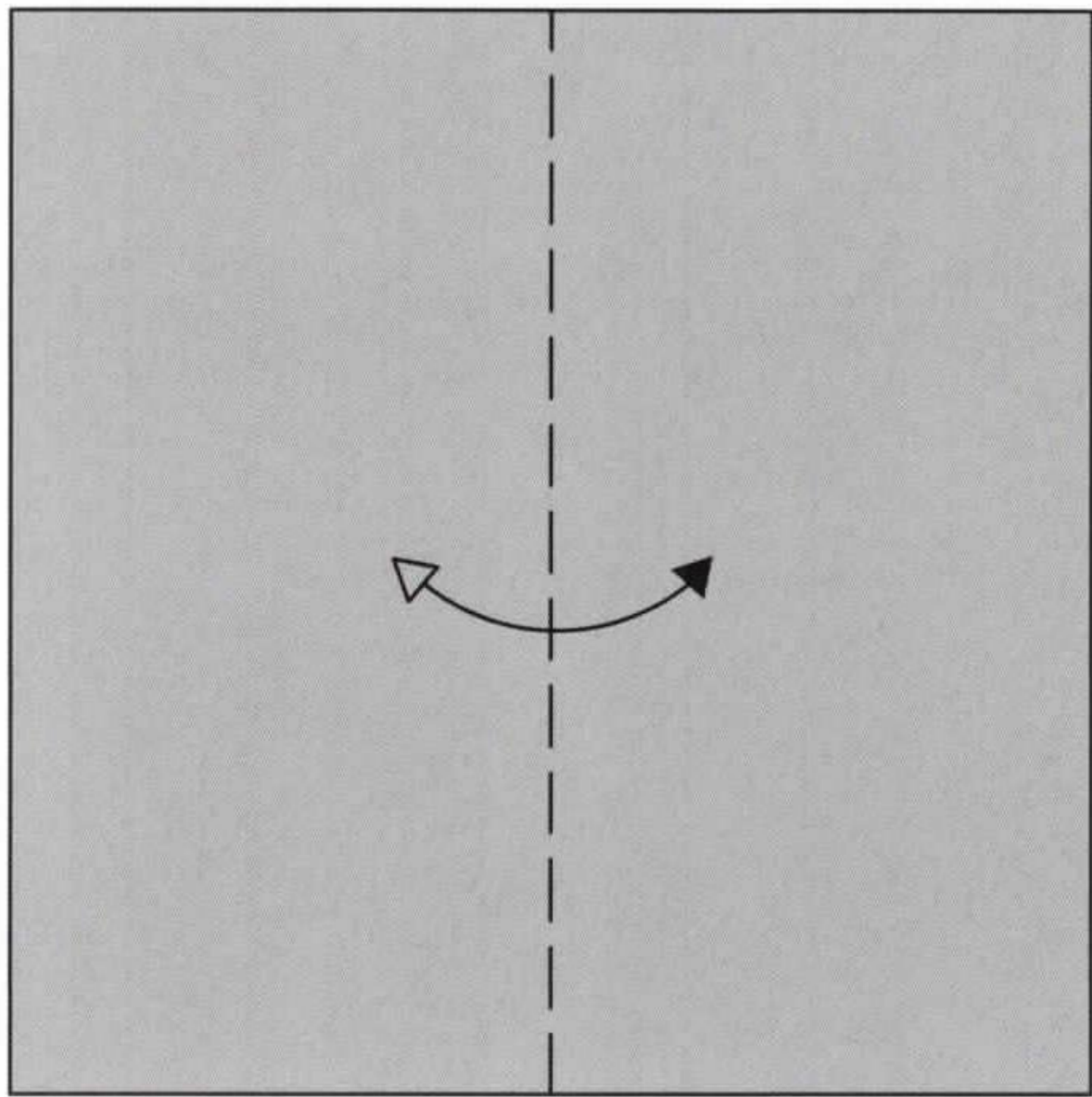

1. Valley fold and unfold

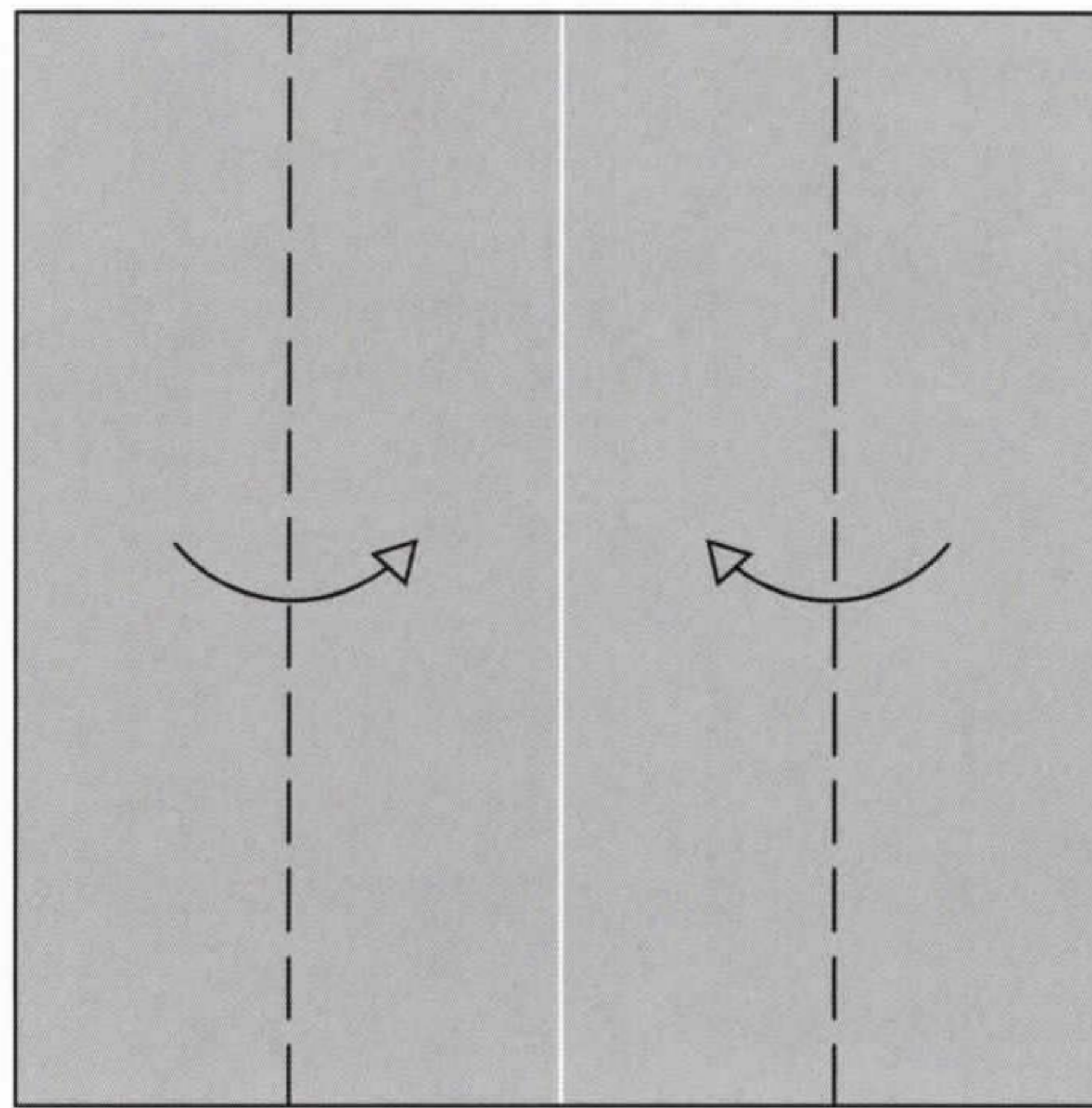

2. Valley folds

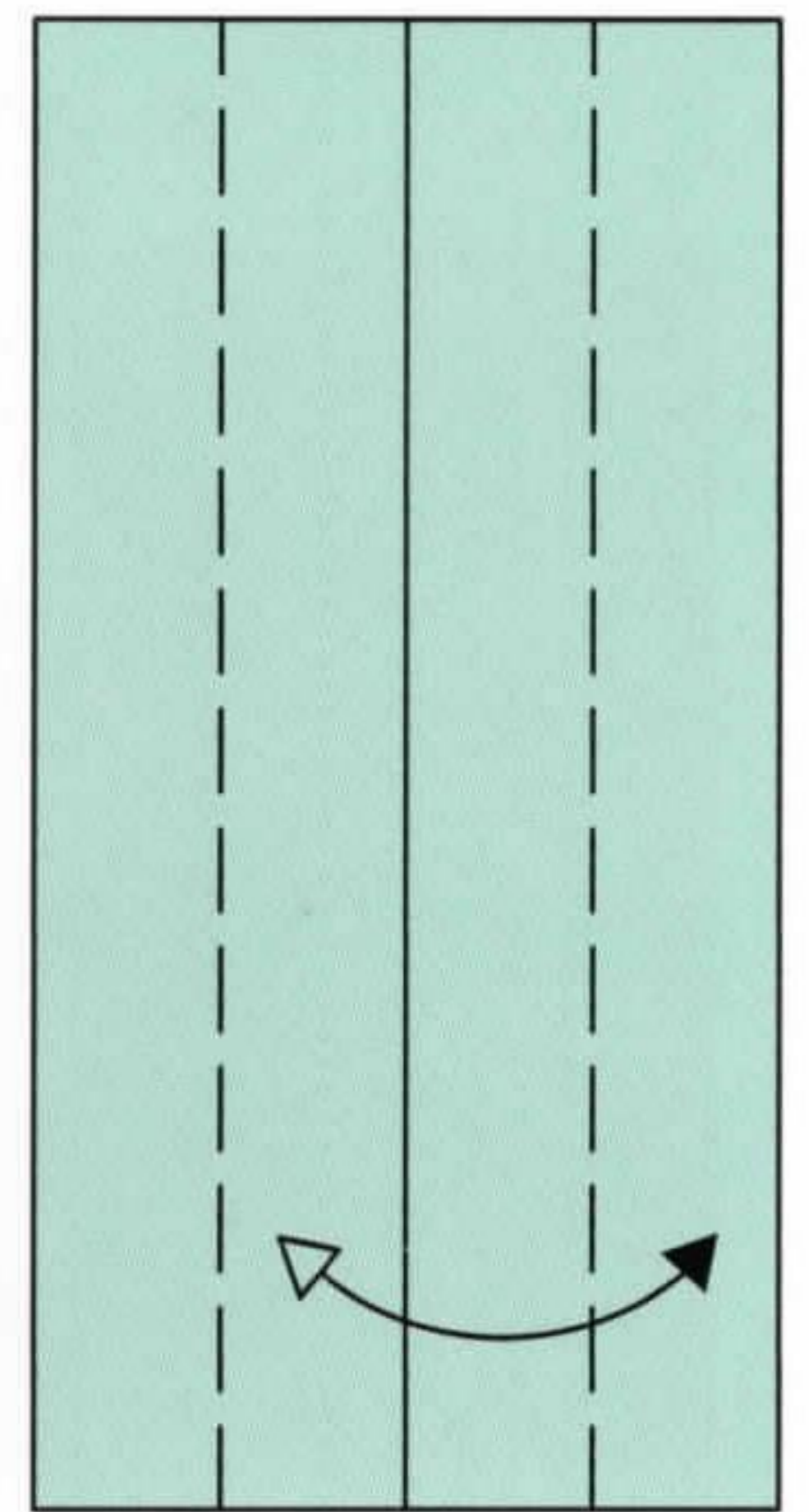

3. Valley folds and unfold

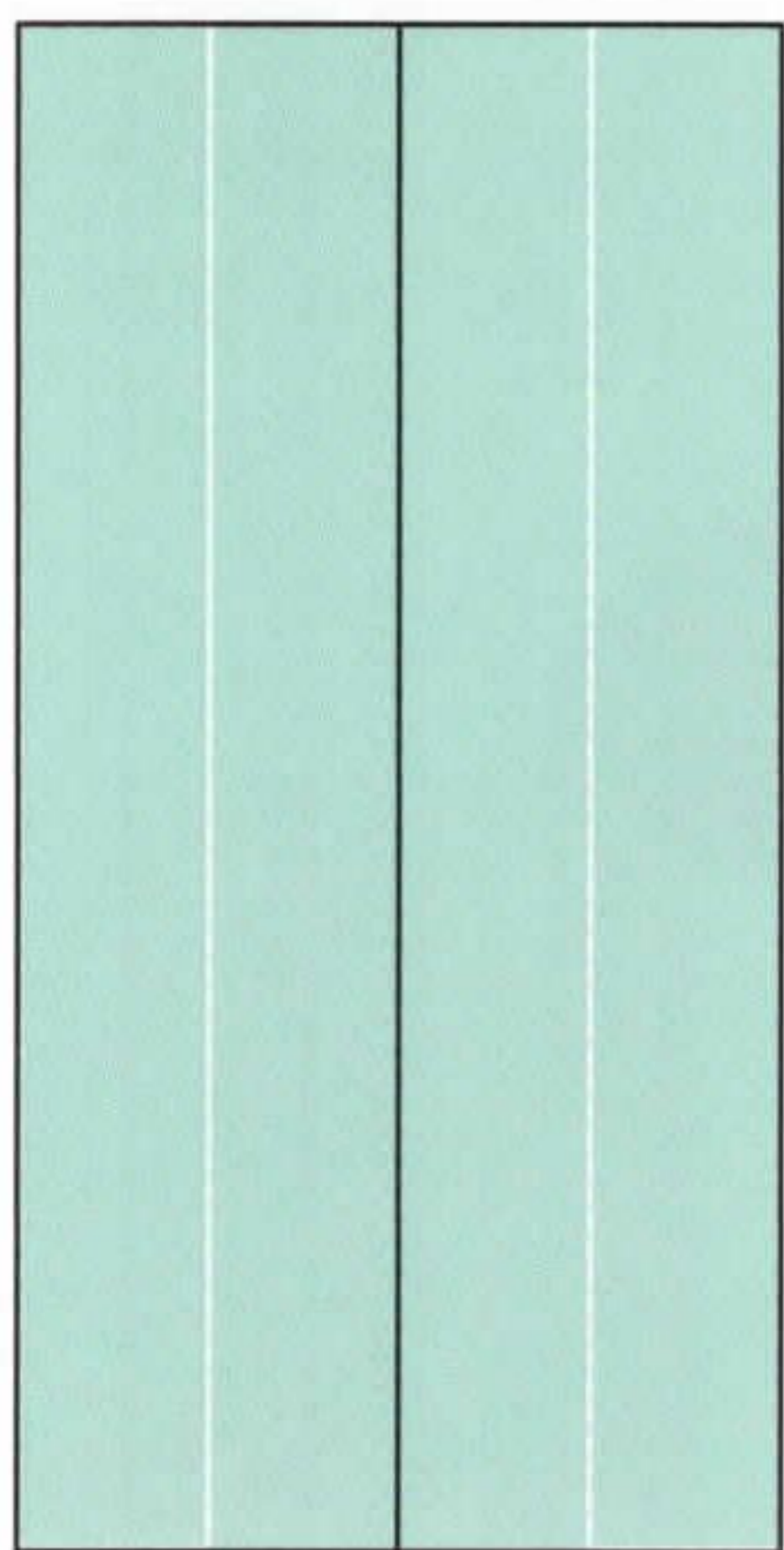

4. Scale-up

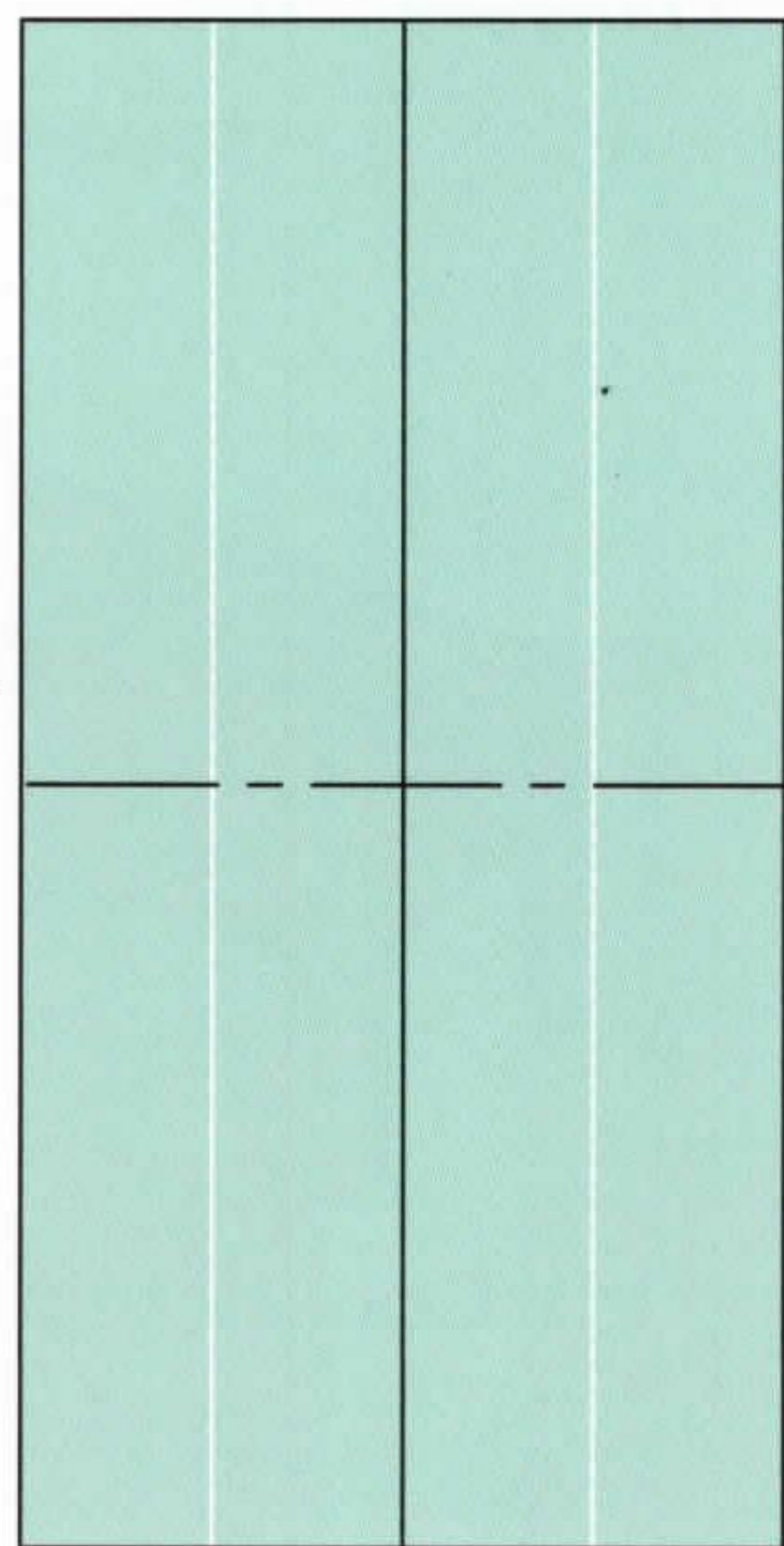

5. Mountain fold

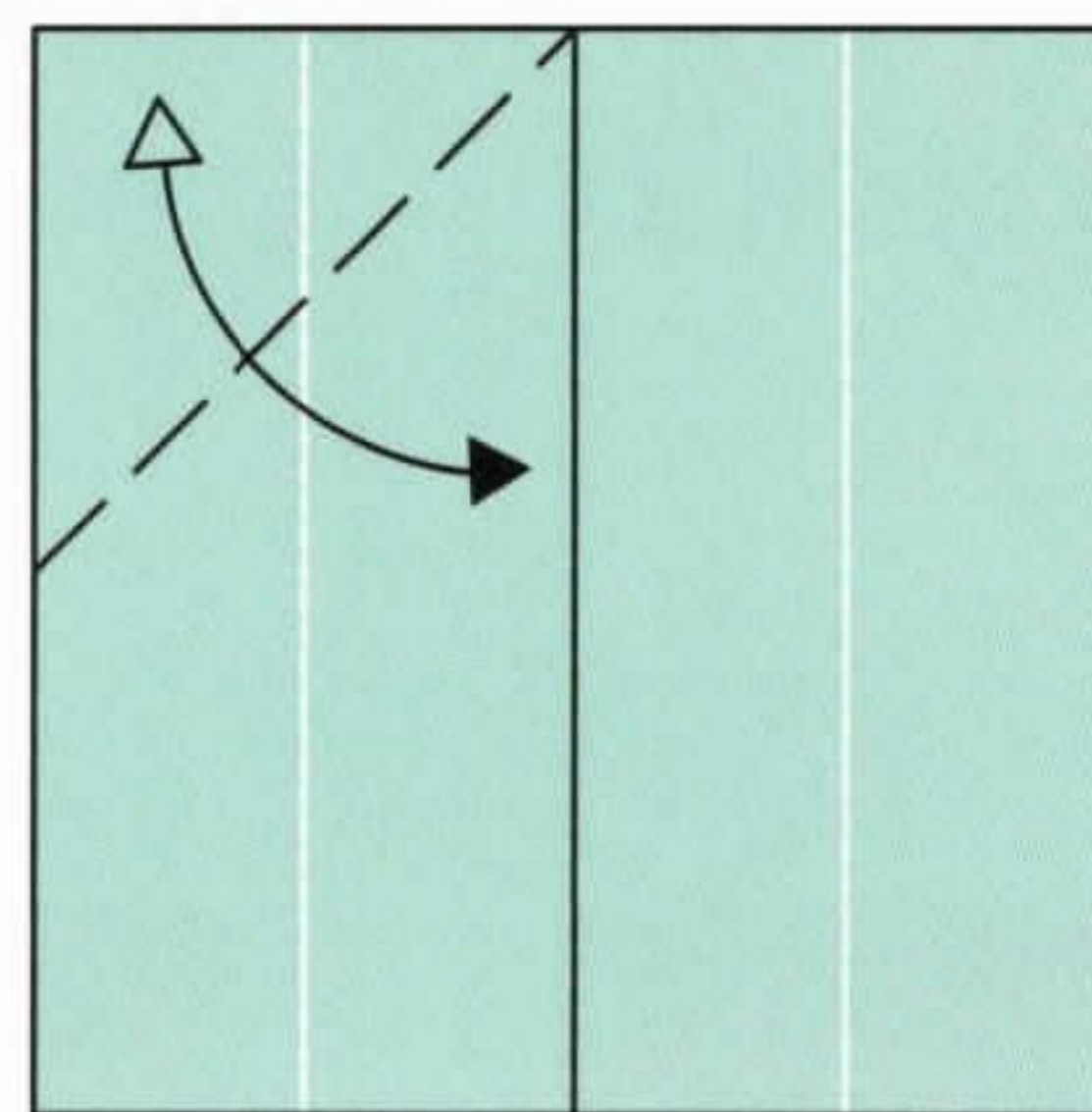

6. Valley fold and unfold

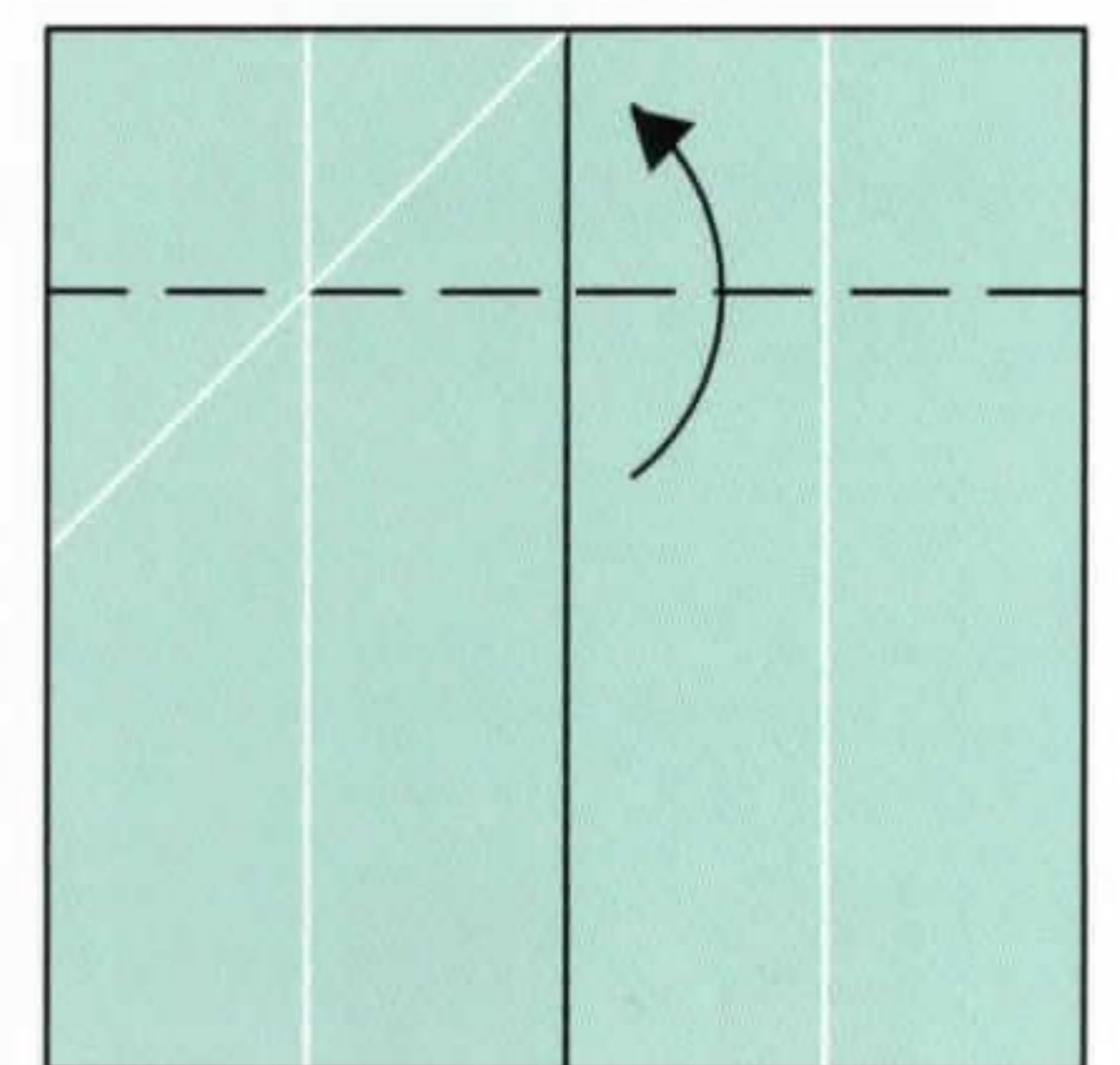

7. Valley fold

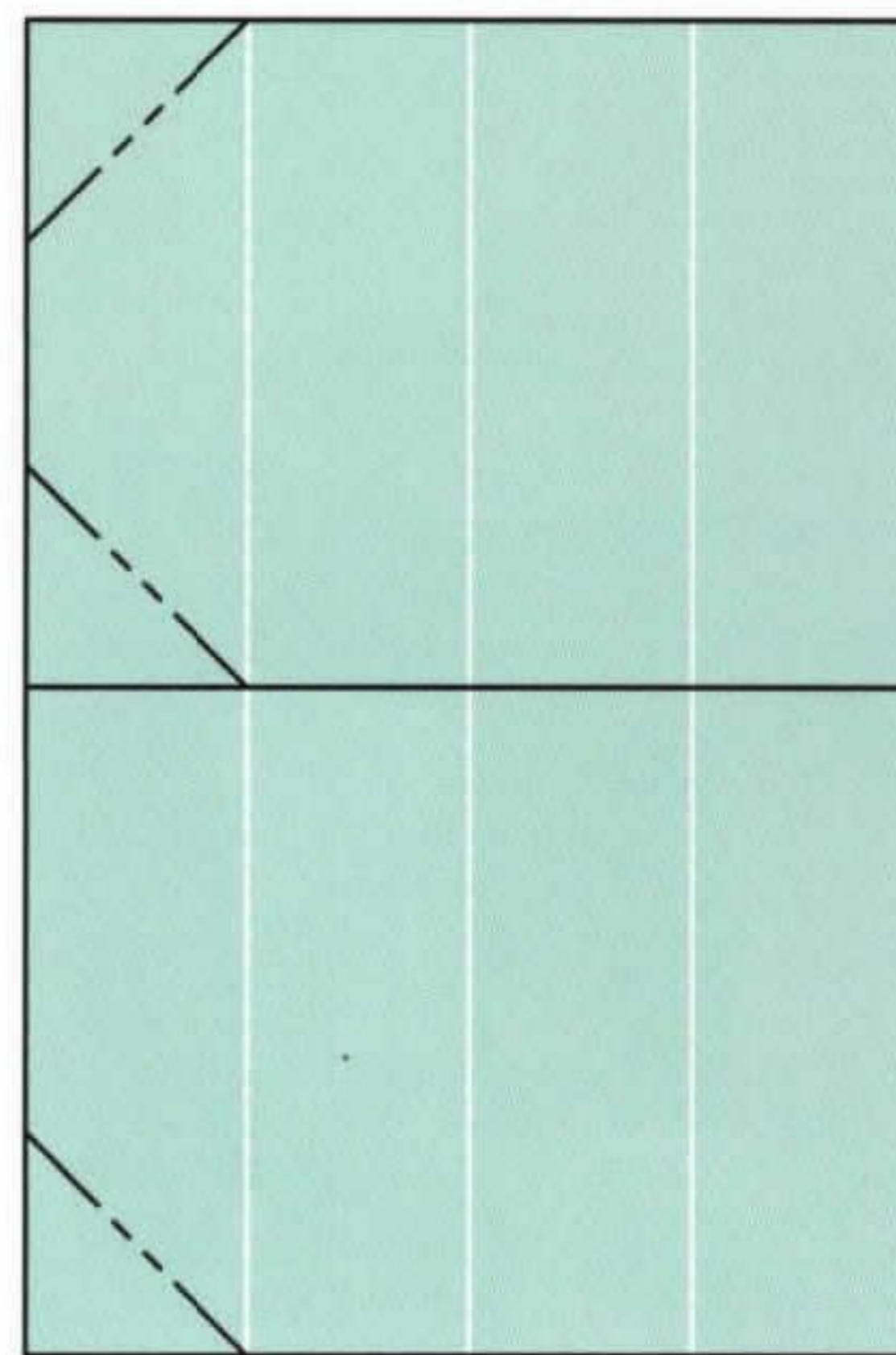

8. Inside reverse folds

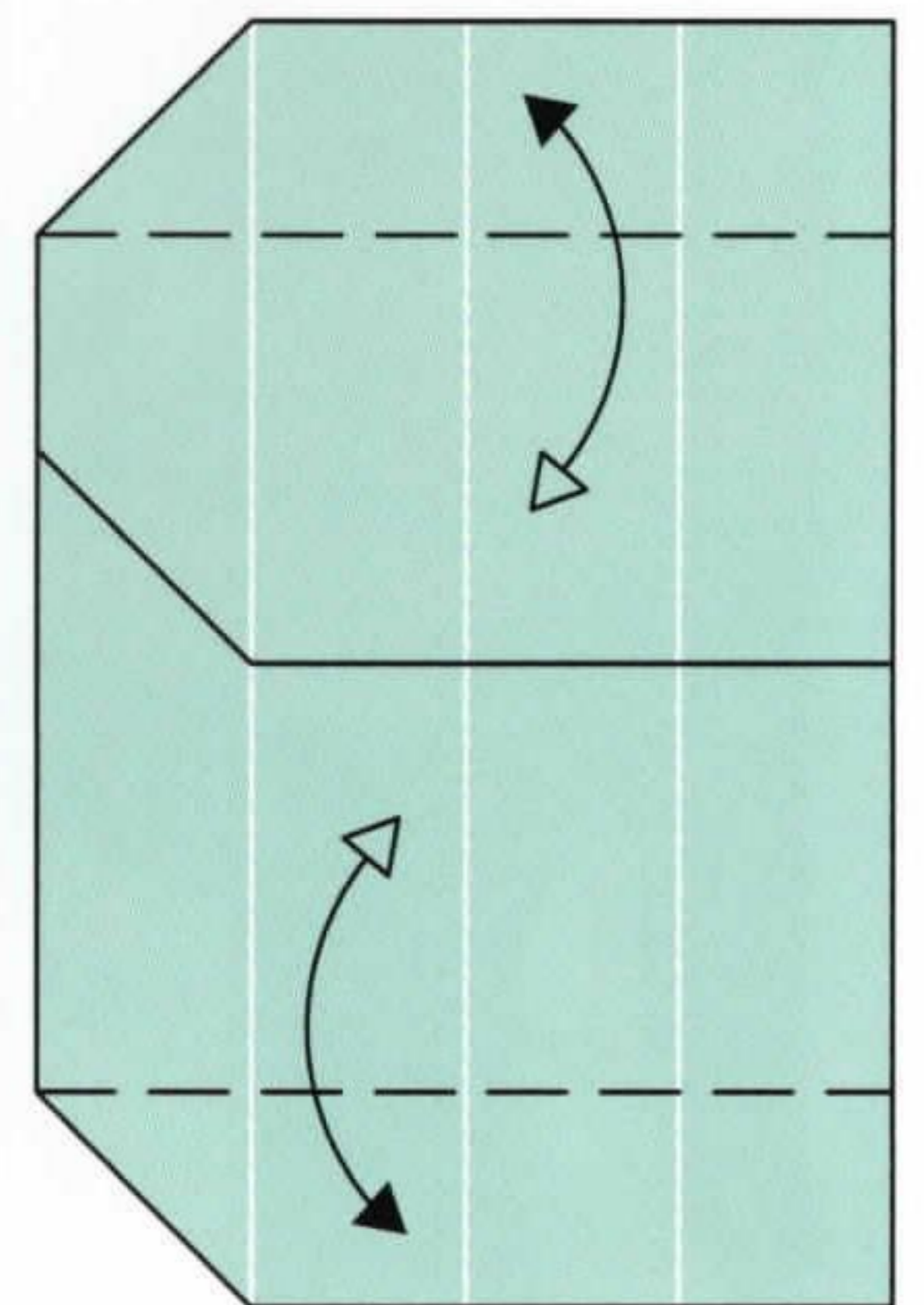

9. Valley folds and unfold

couch: part 1

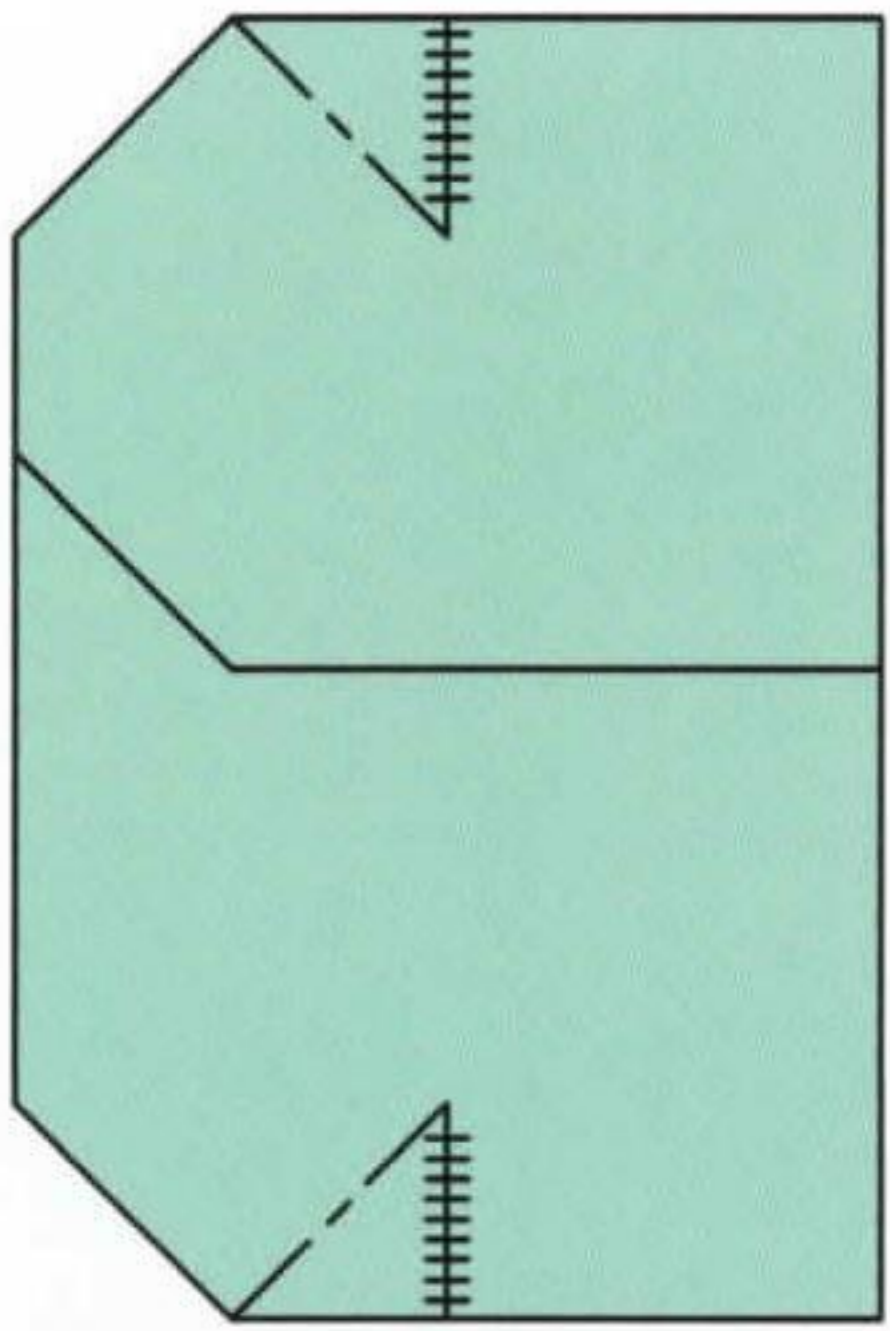

10. Cuts and mountain fold both sides

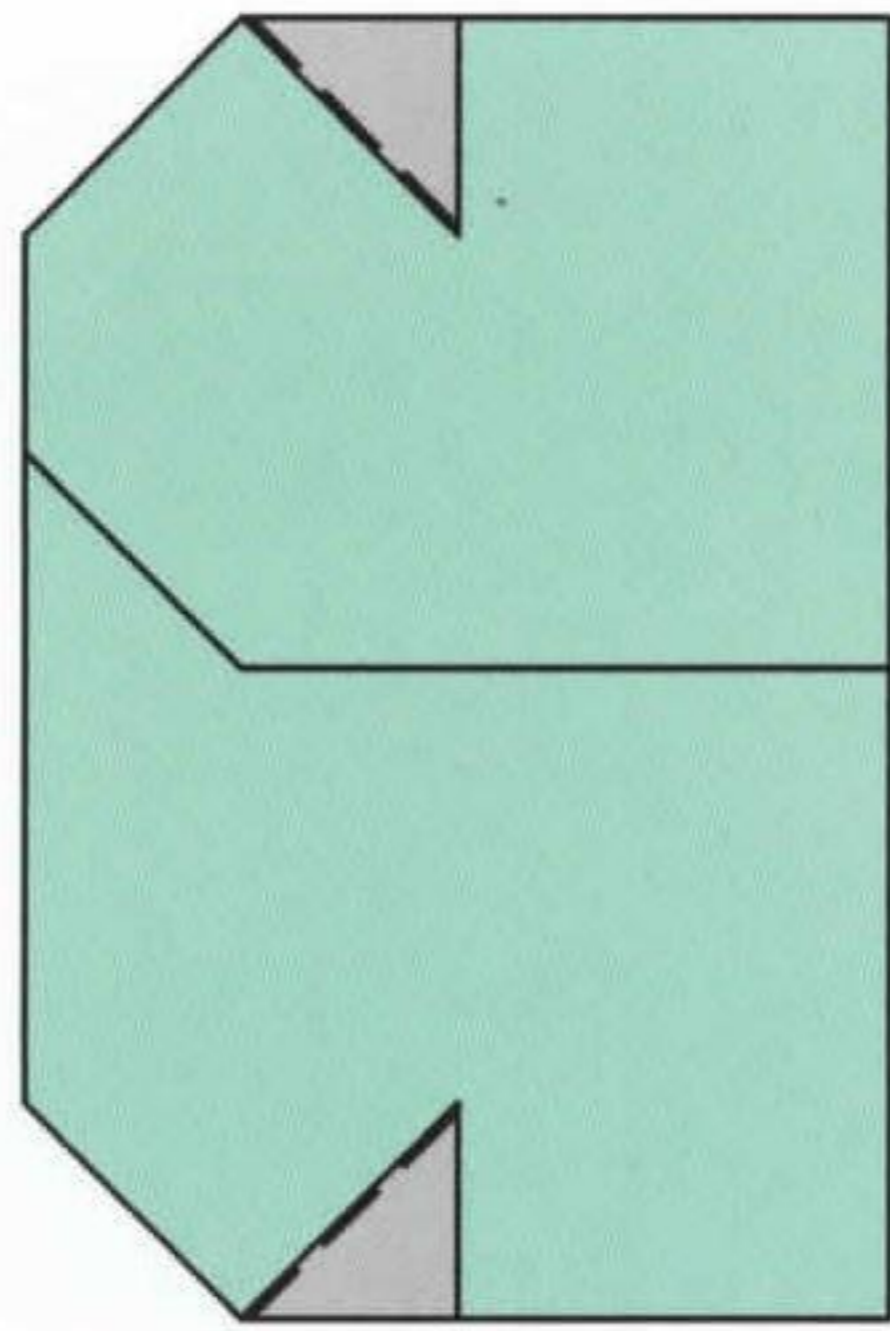

11. Valley folds to tuck-in

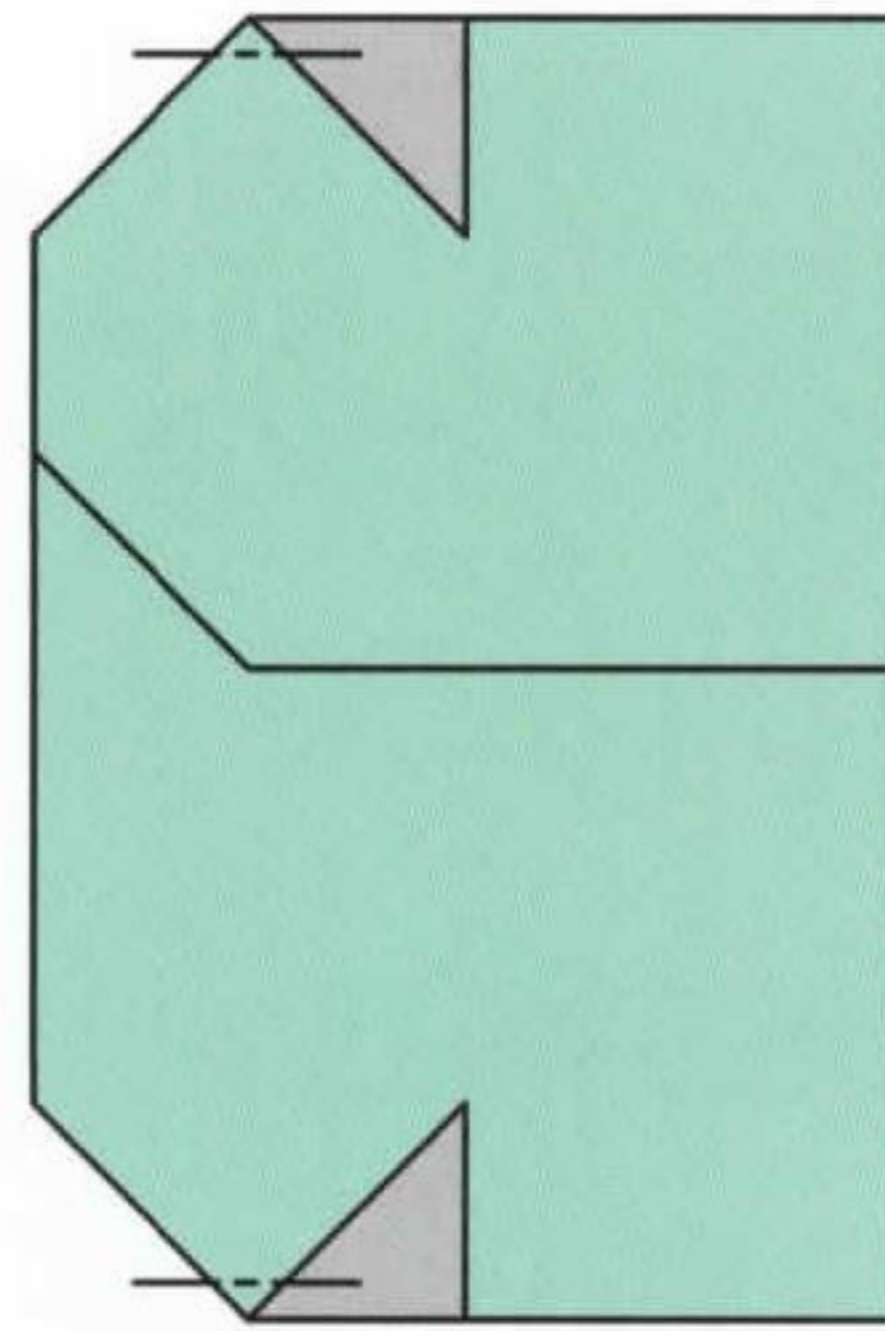

12. Repeat steps 10 and 11

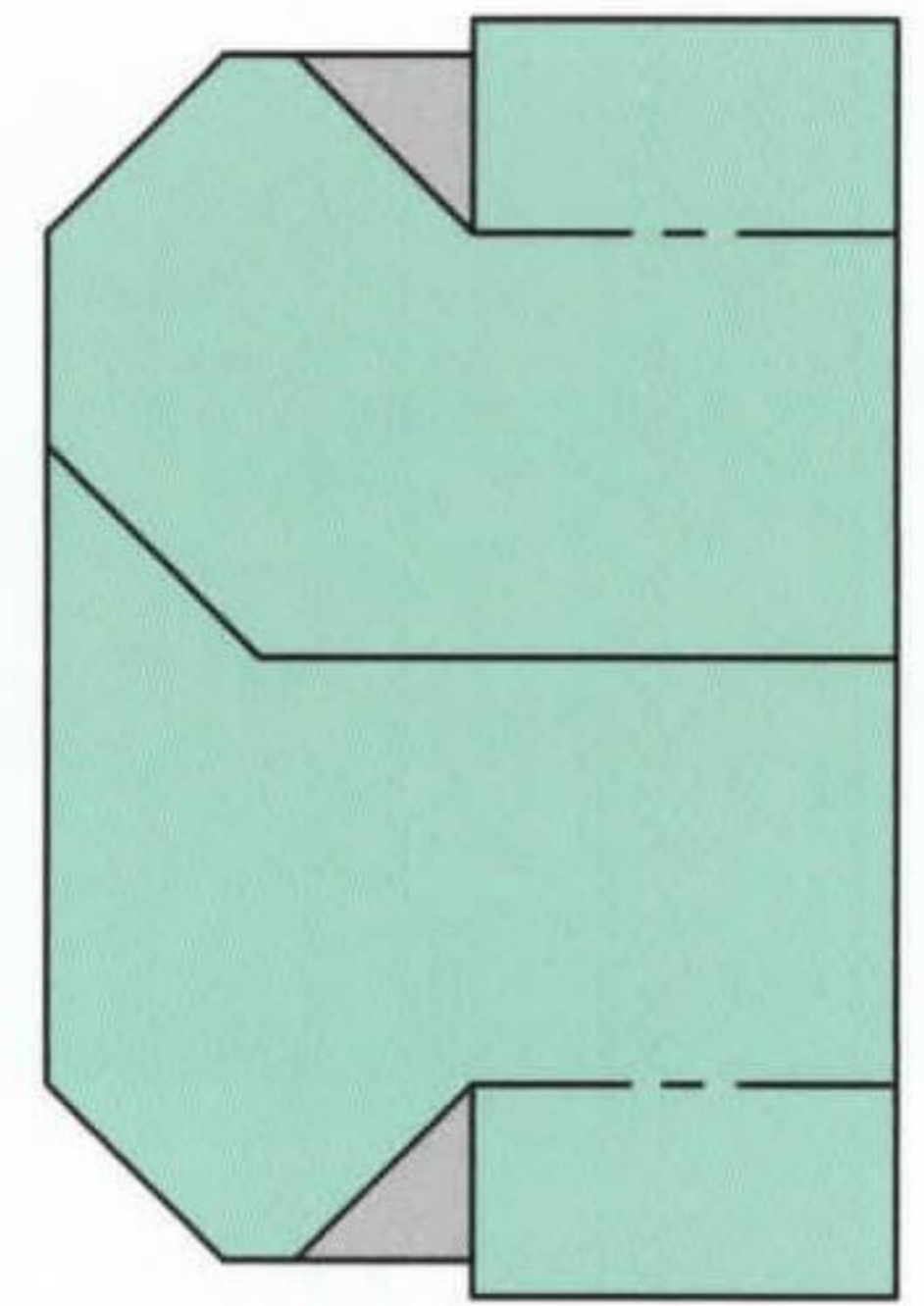

13. Mountain folds

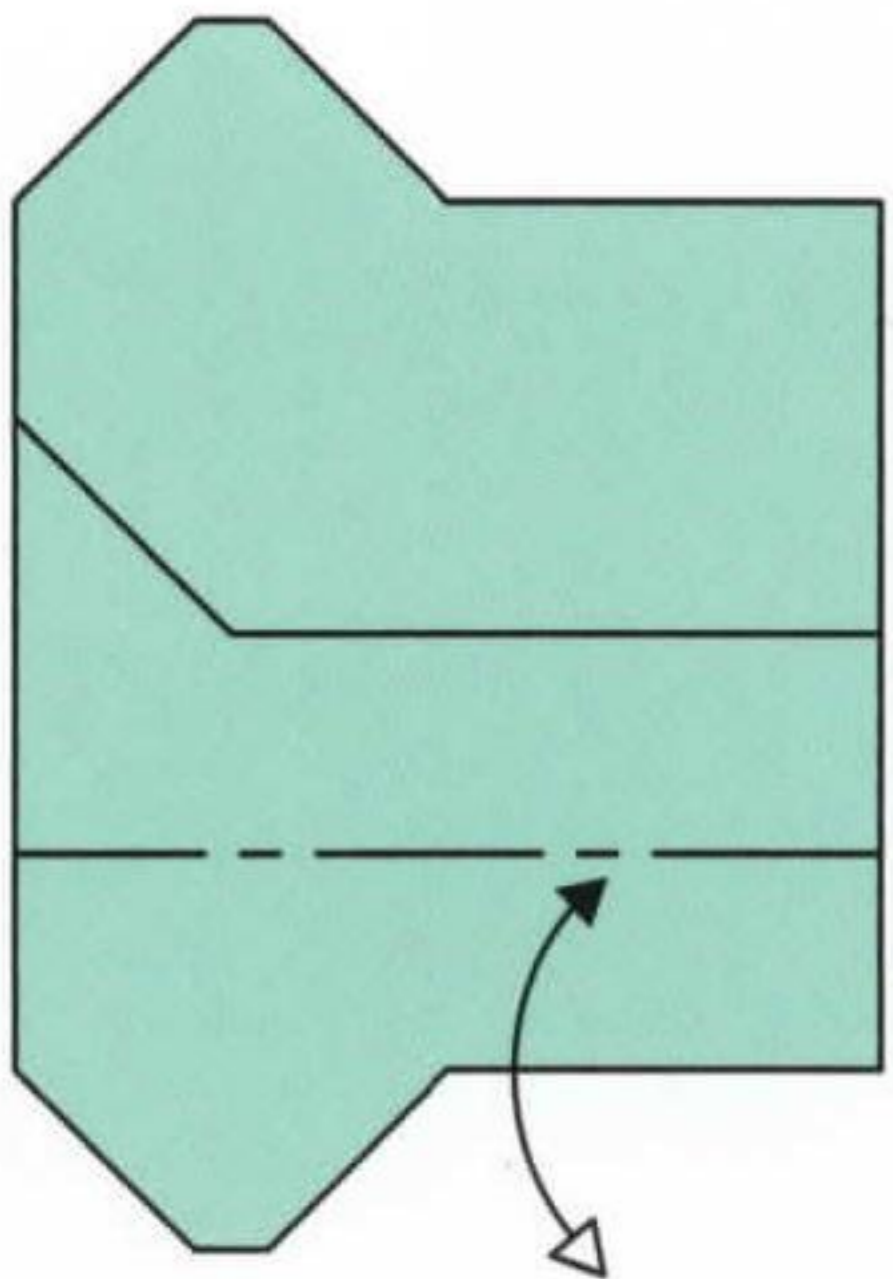

14. Mountain fold and unfold

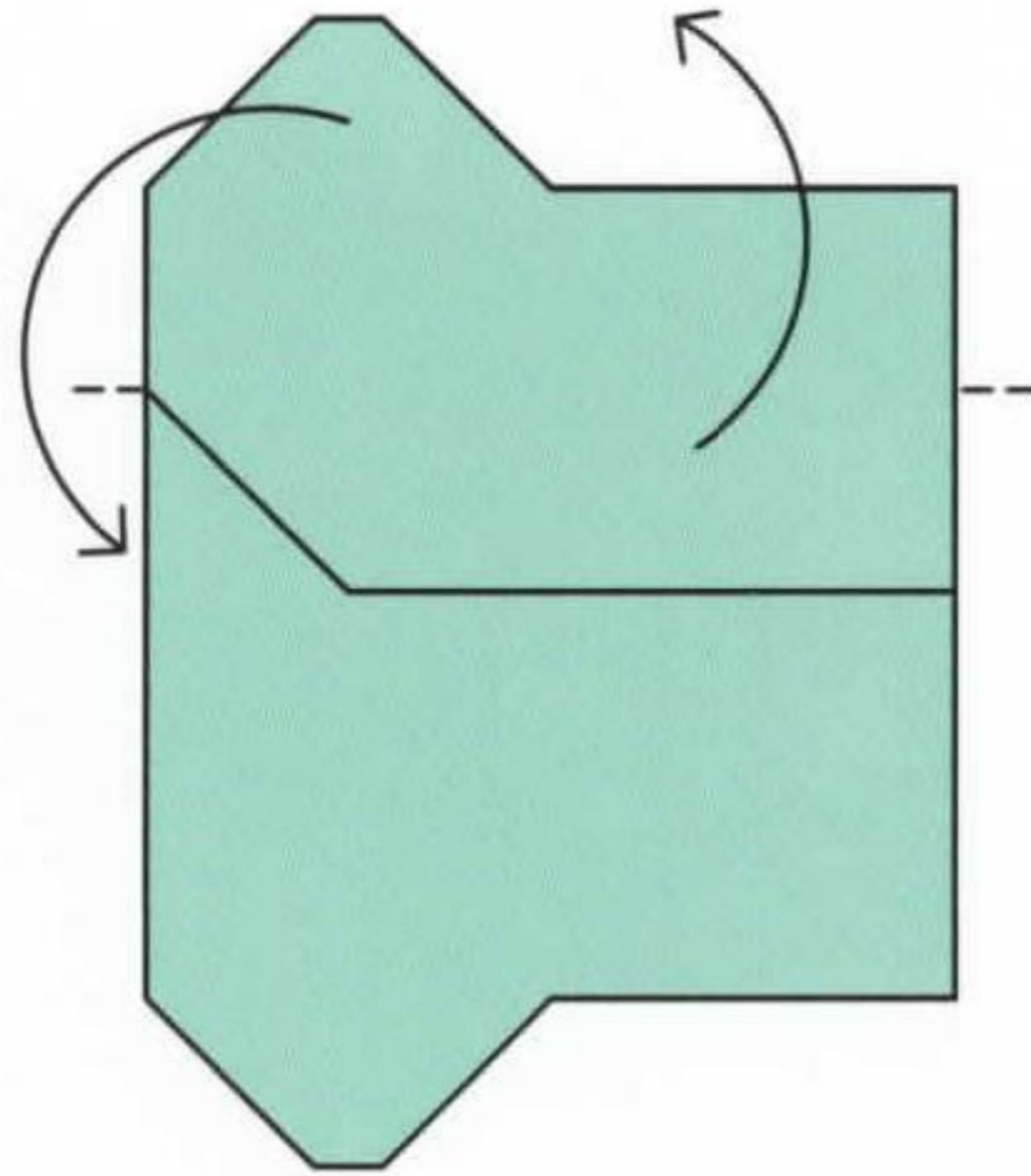

15. Flip upward

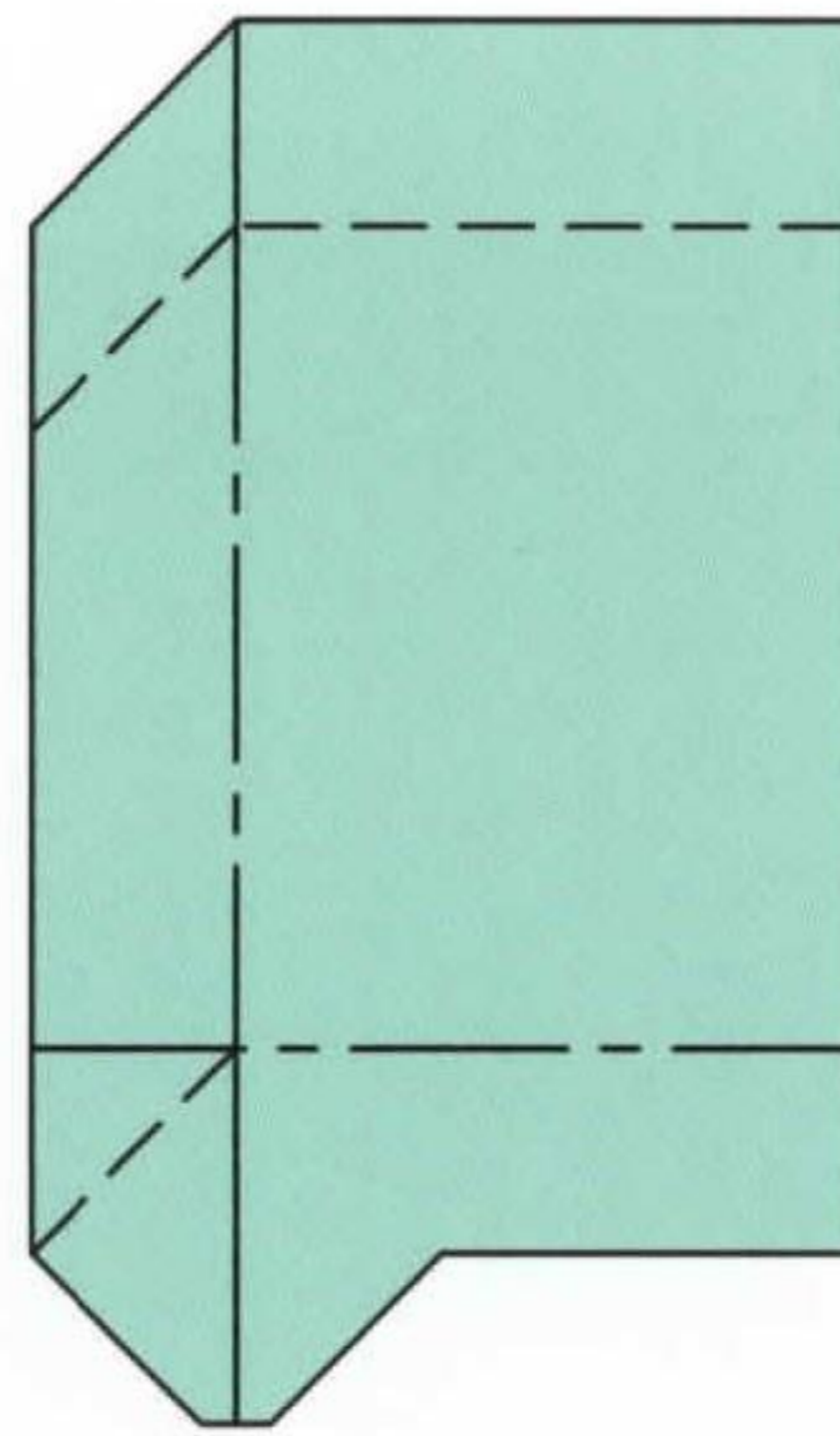

16. Fold along creased lines

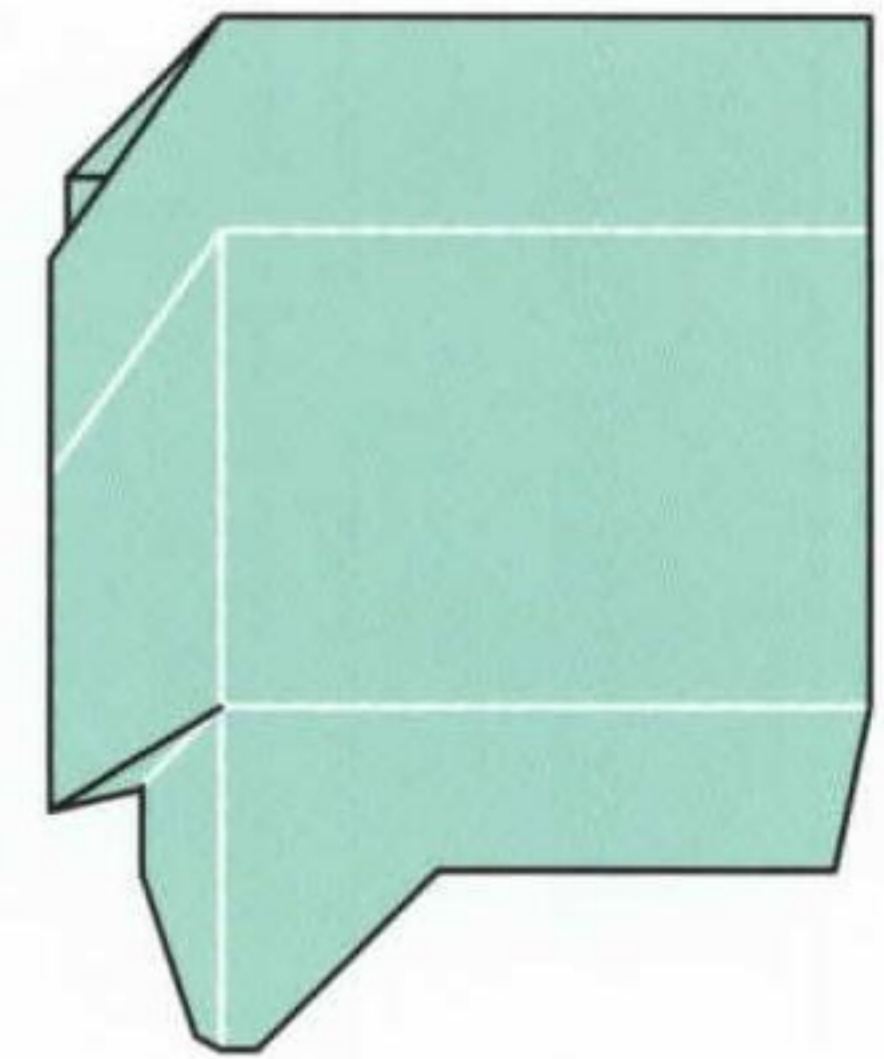

17. Before complete

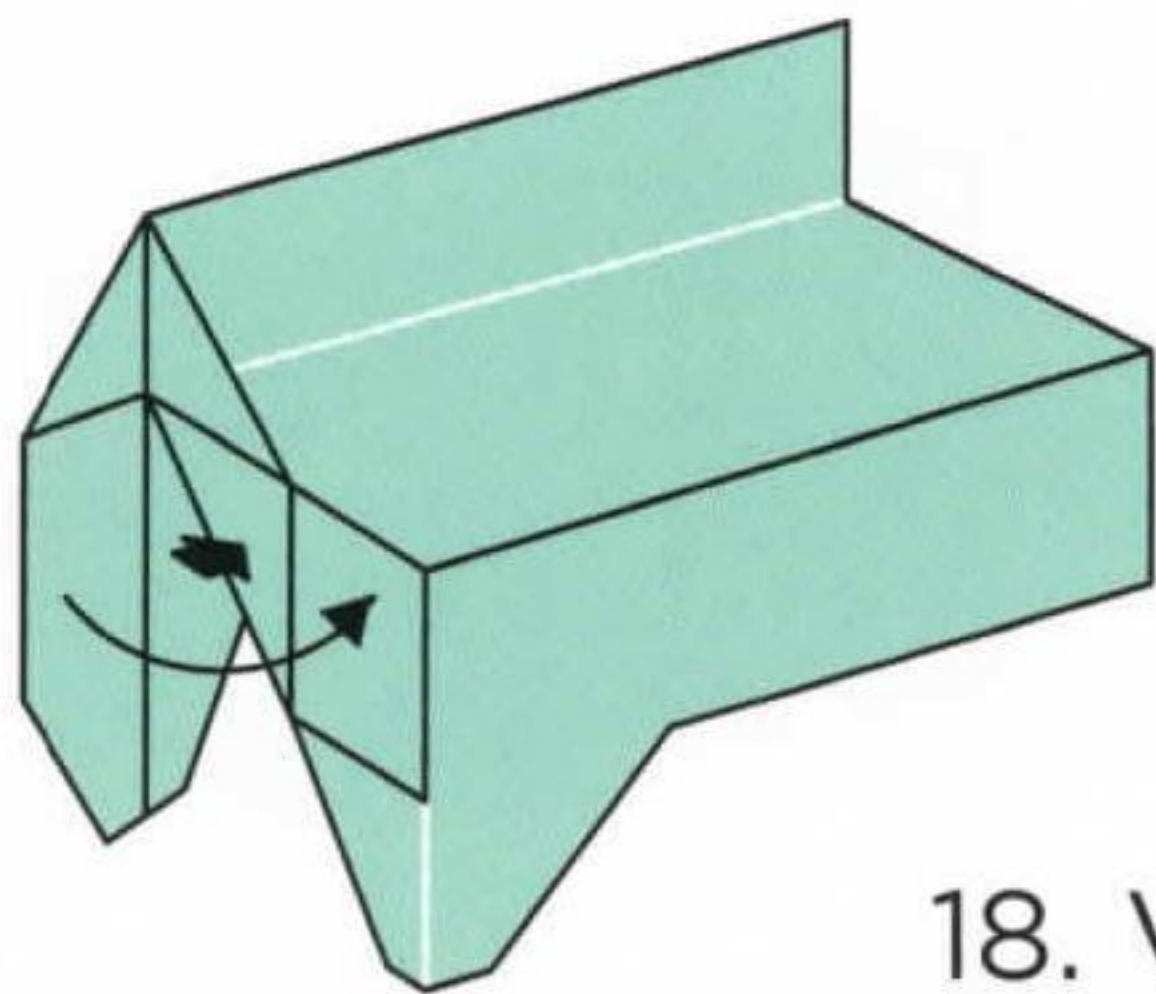

18. Valley fold and apply glue

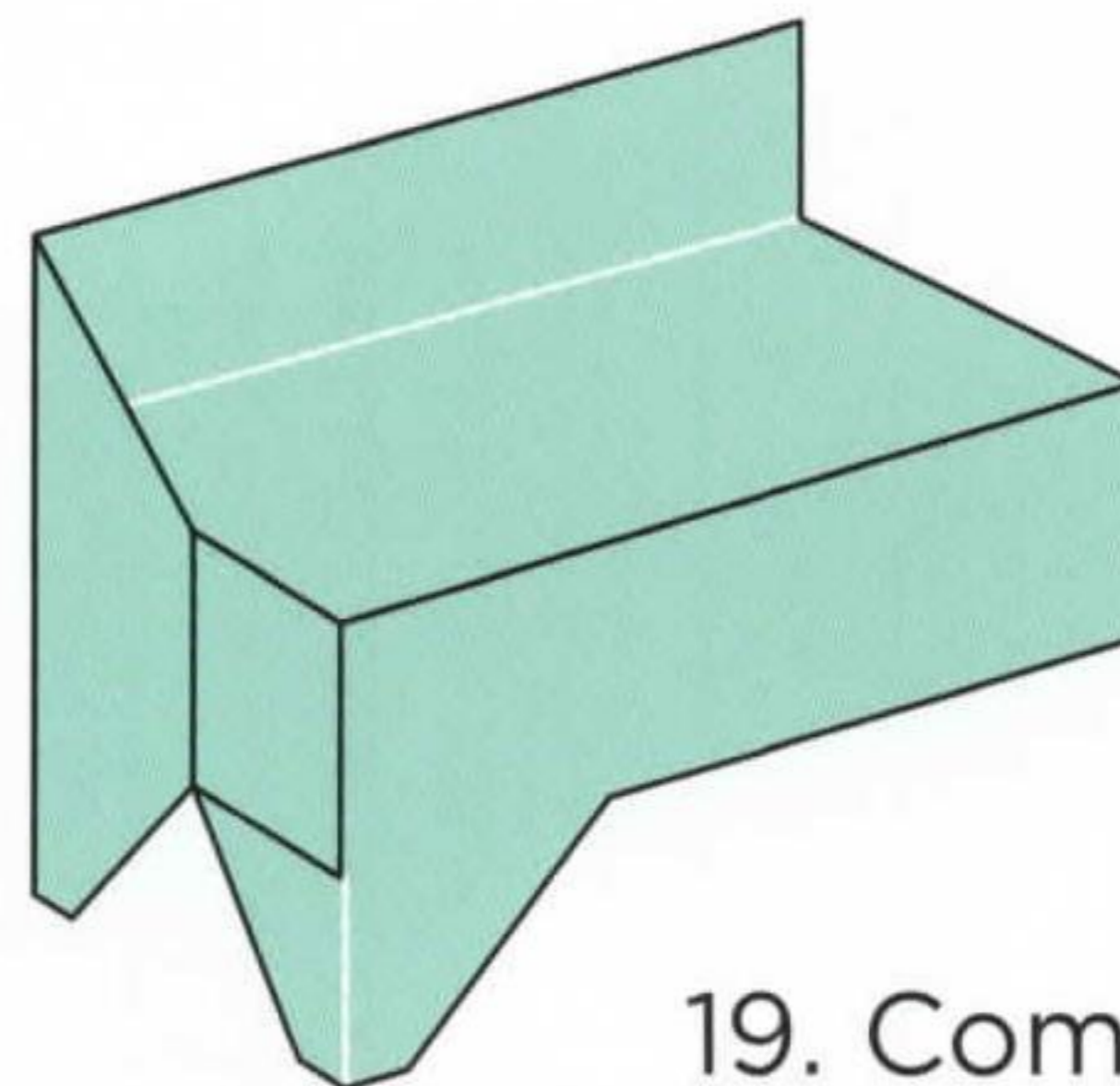

19. Completed COUCH PART 1

couch: part 2

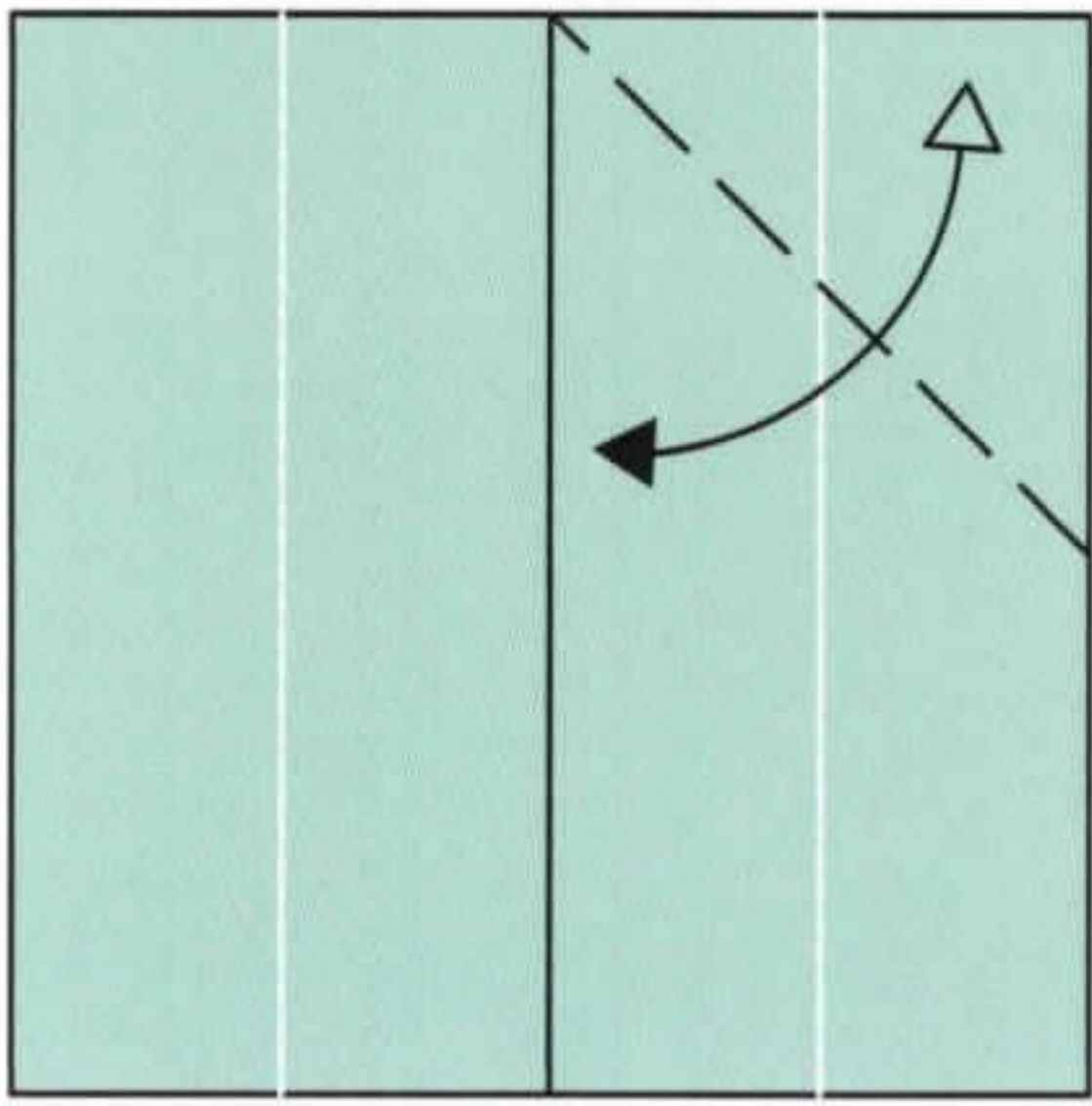

1. Start with Couch, Part 1, step 6. (Valley fold and unfold).

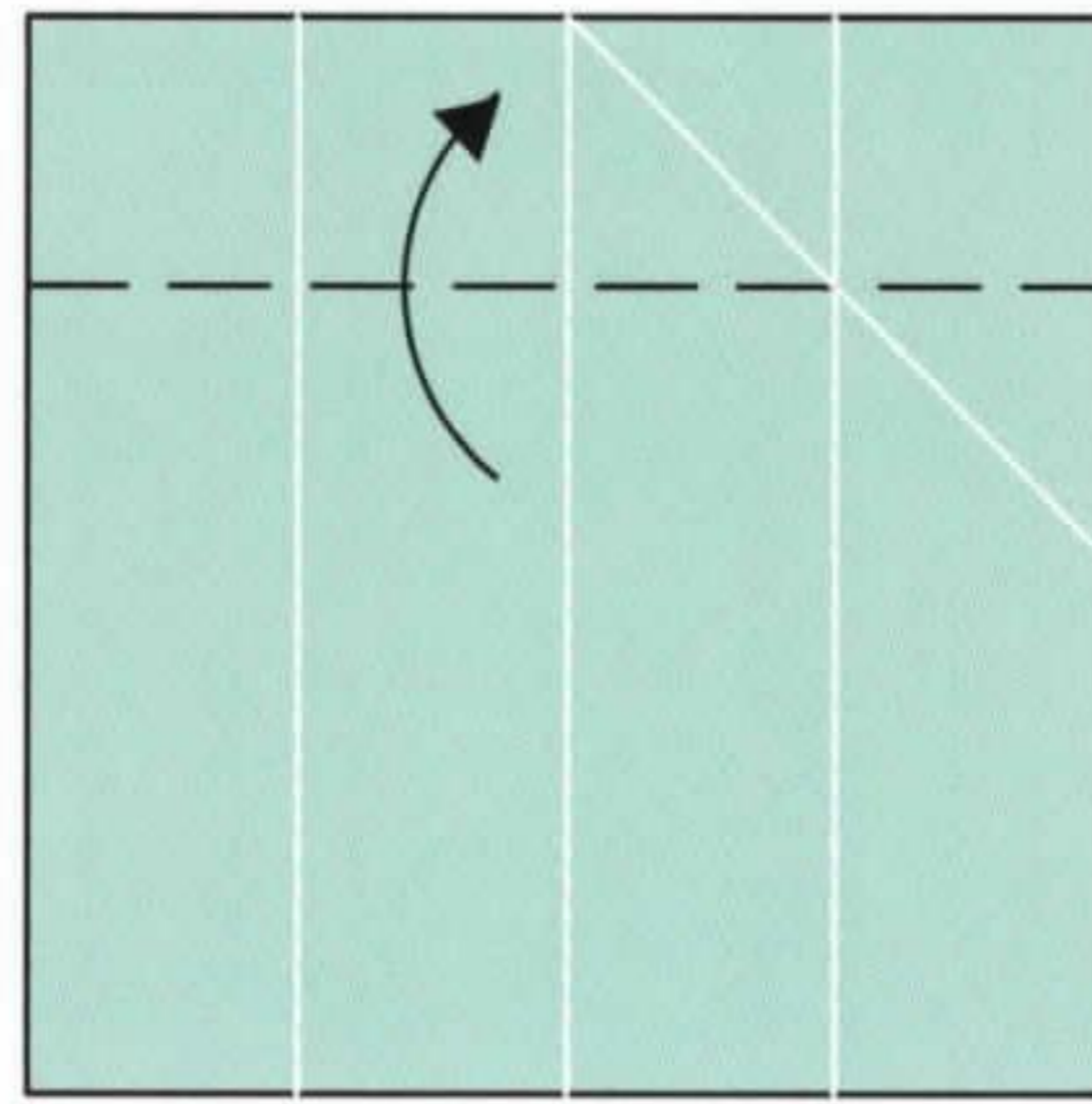

2. Valley fold

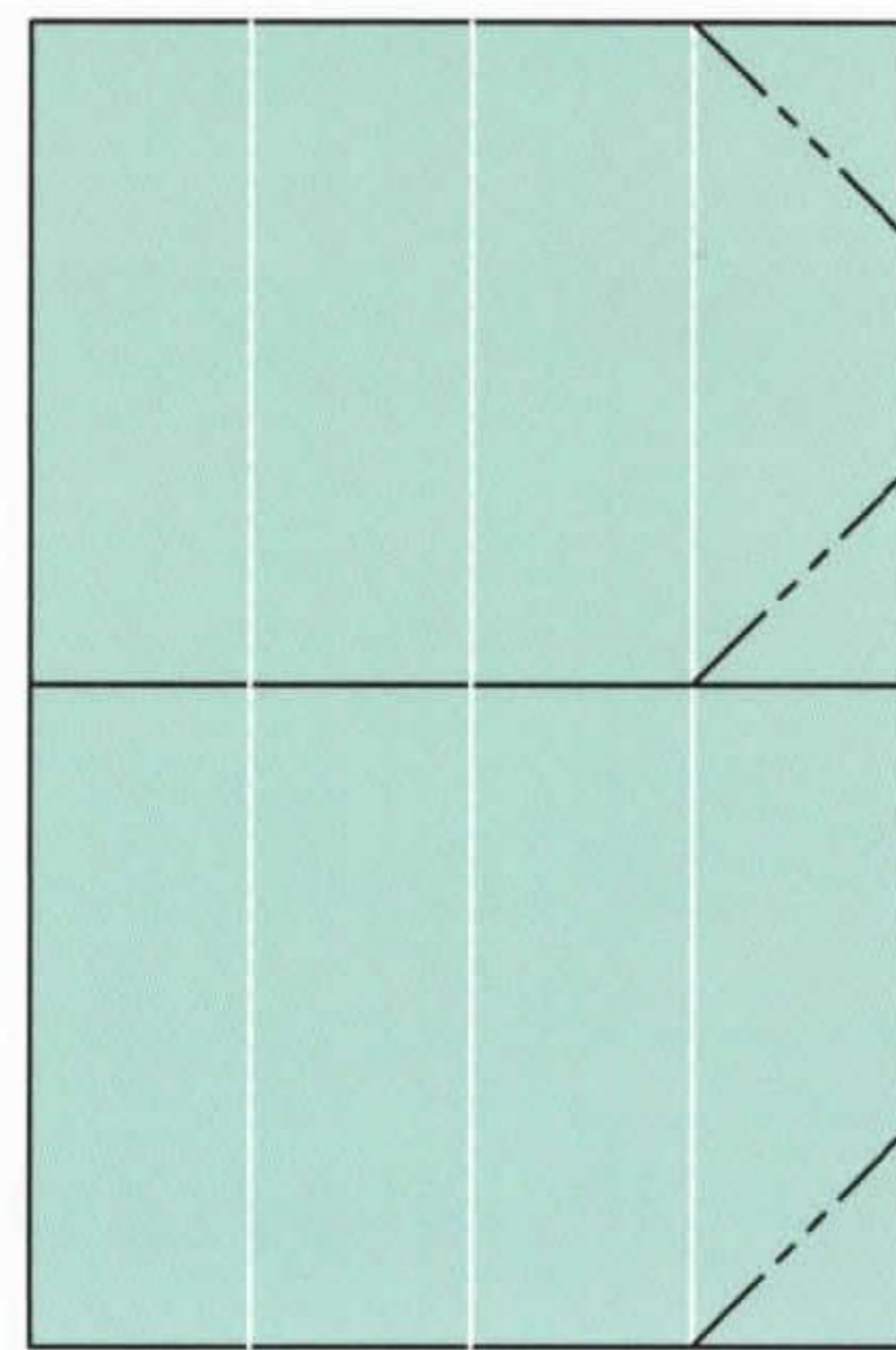

3. Inside reverse folds

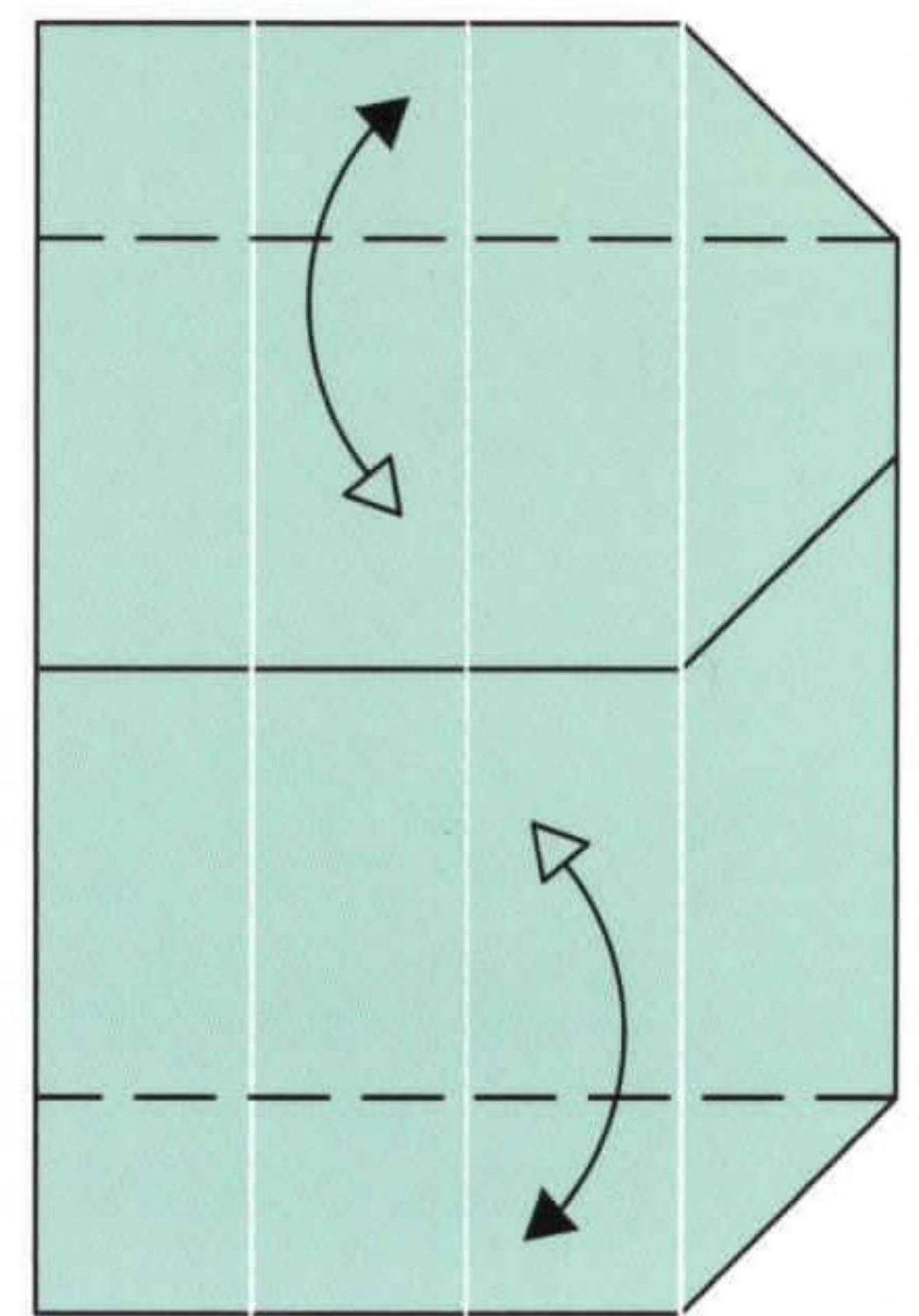

4. Valley folds and unfold

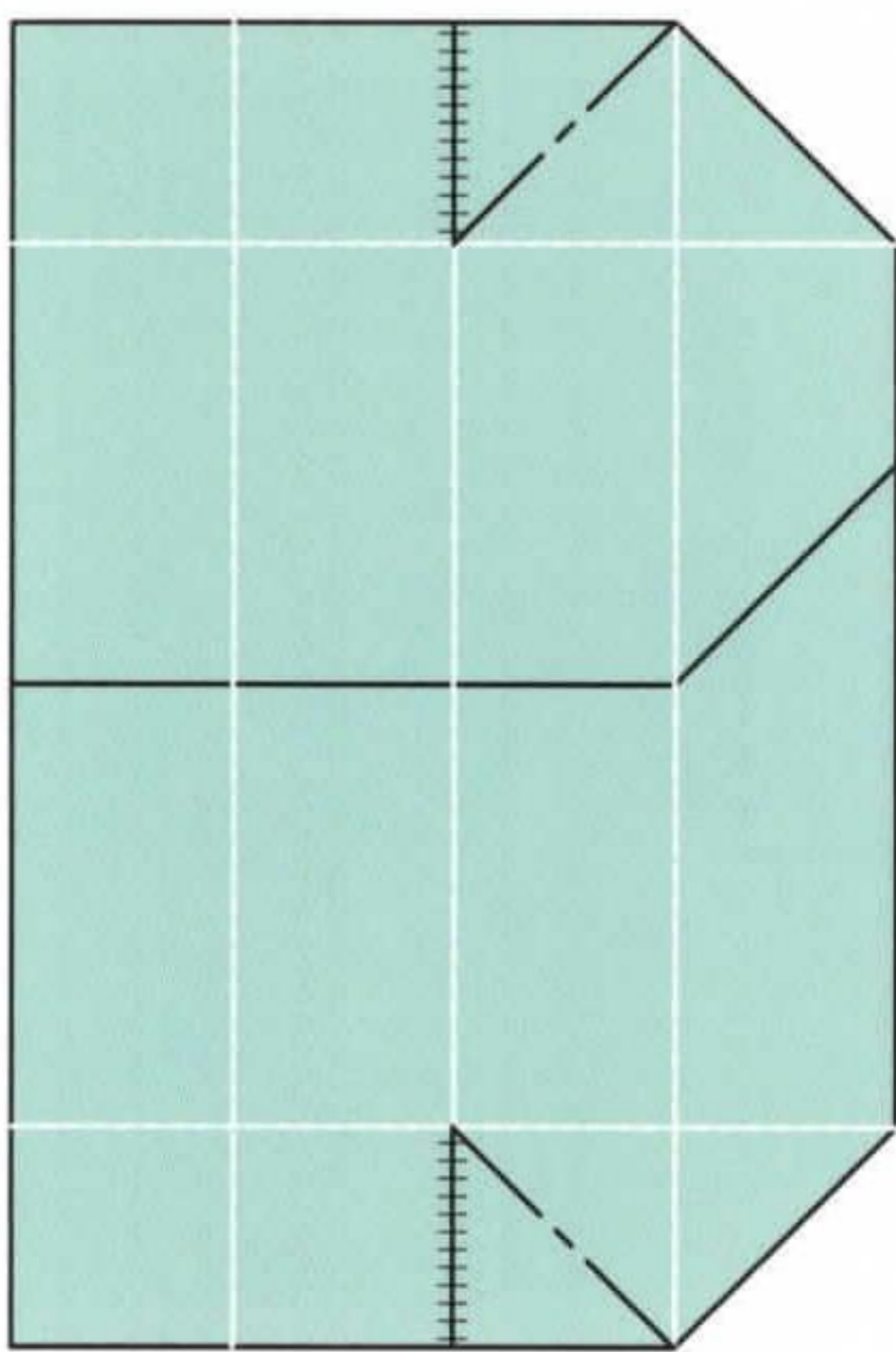

5. Cuts and Mountain fold cut parts

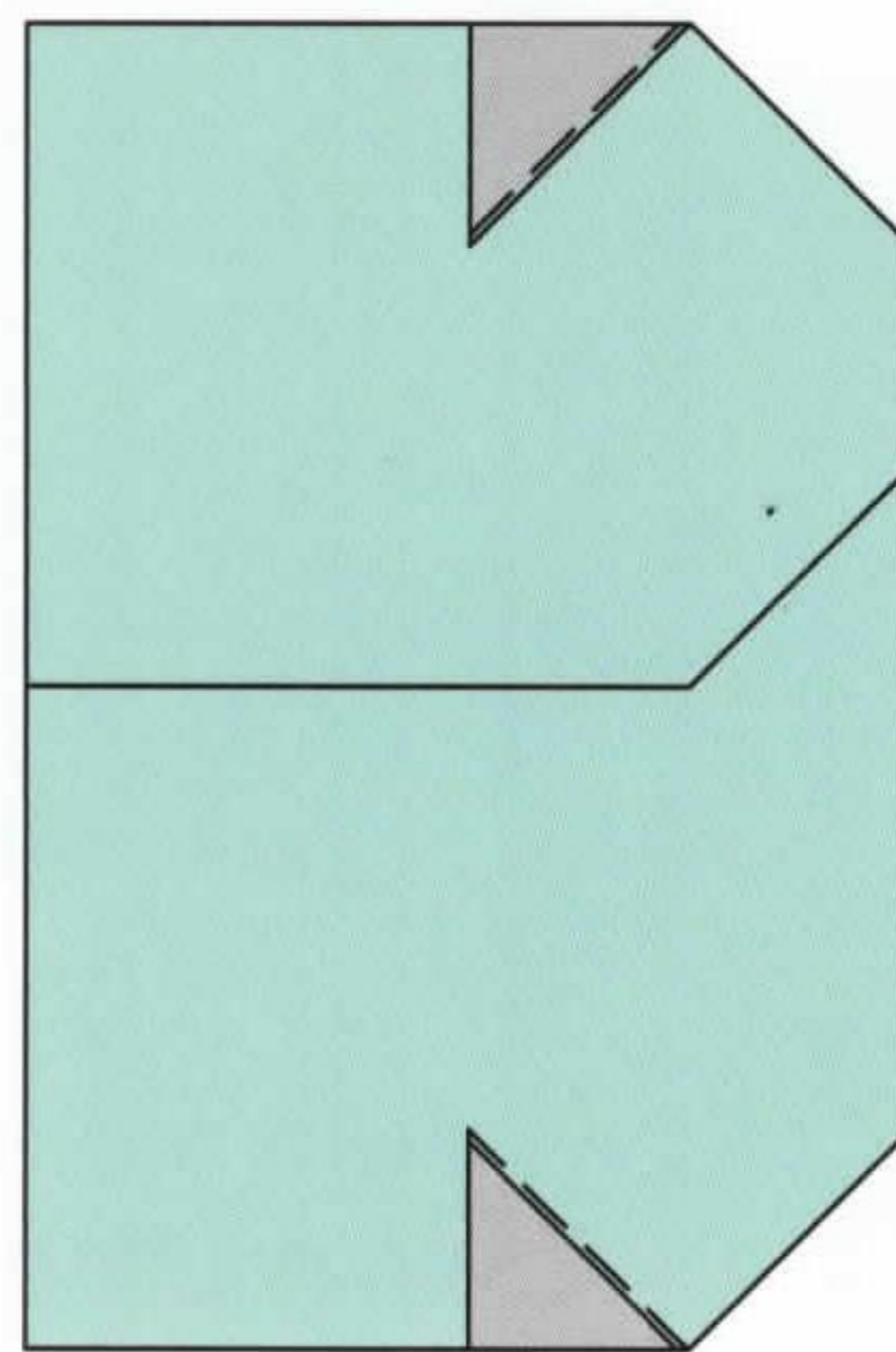

6. Valley folds to tuck-in

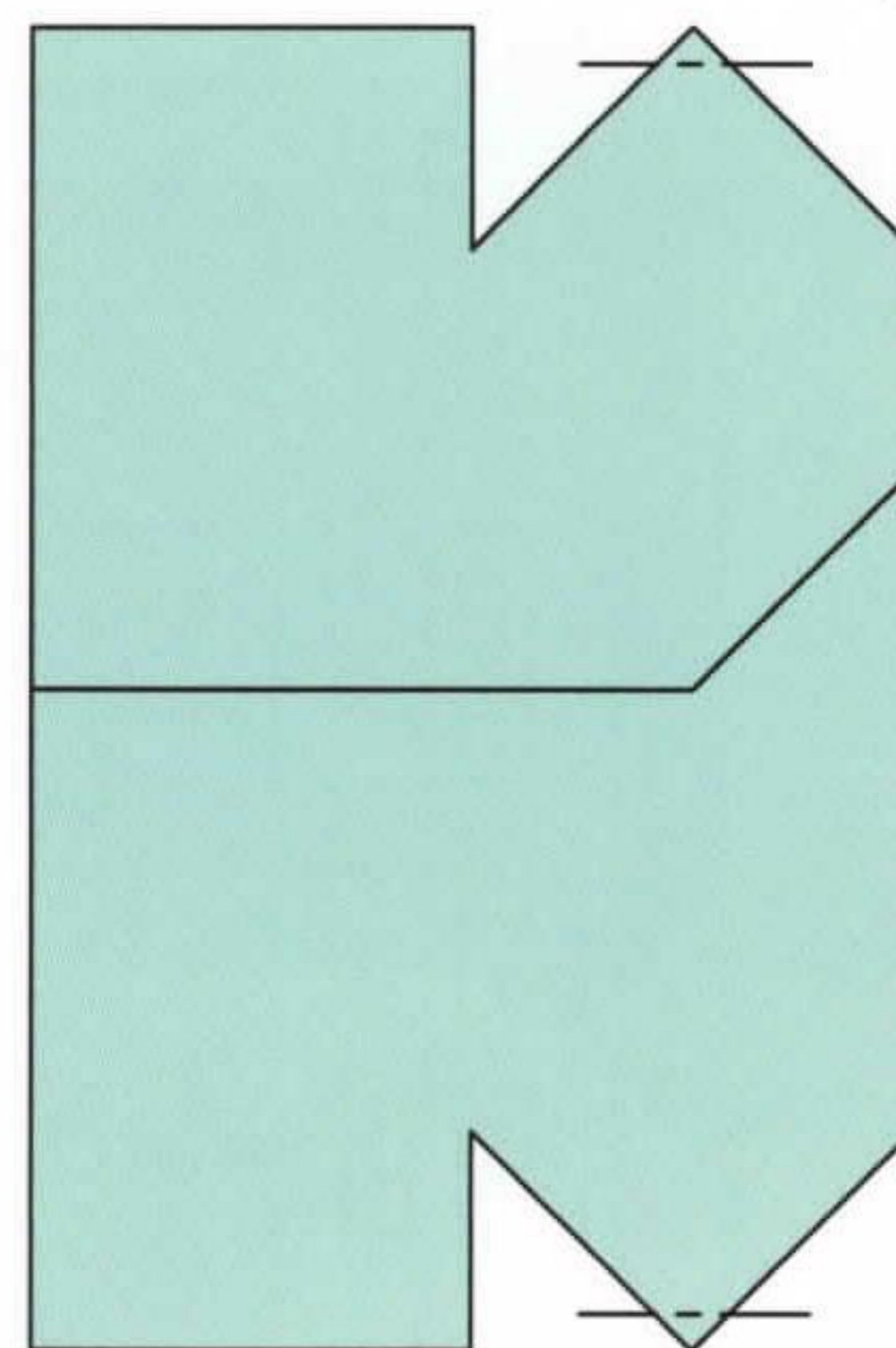

7. Repeat steps 5 and 6

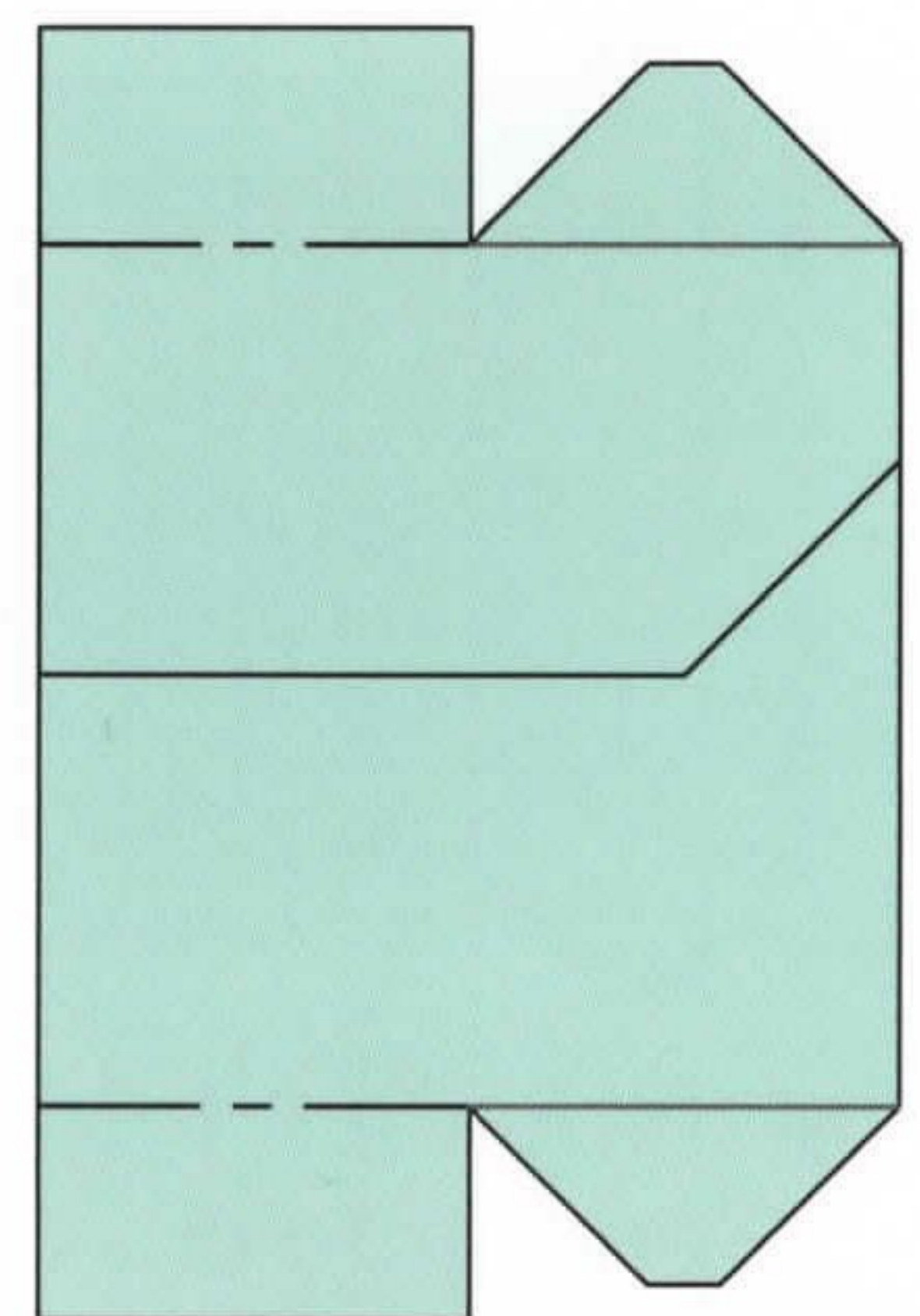

8. Mountain folds

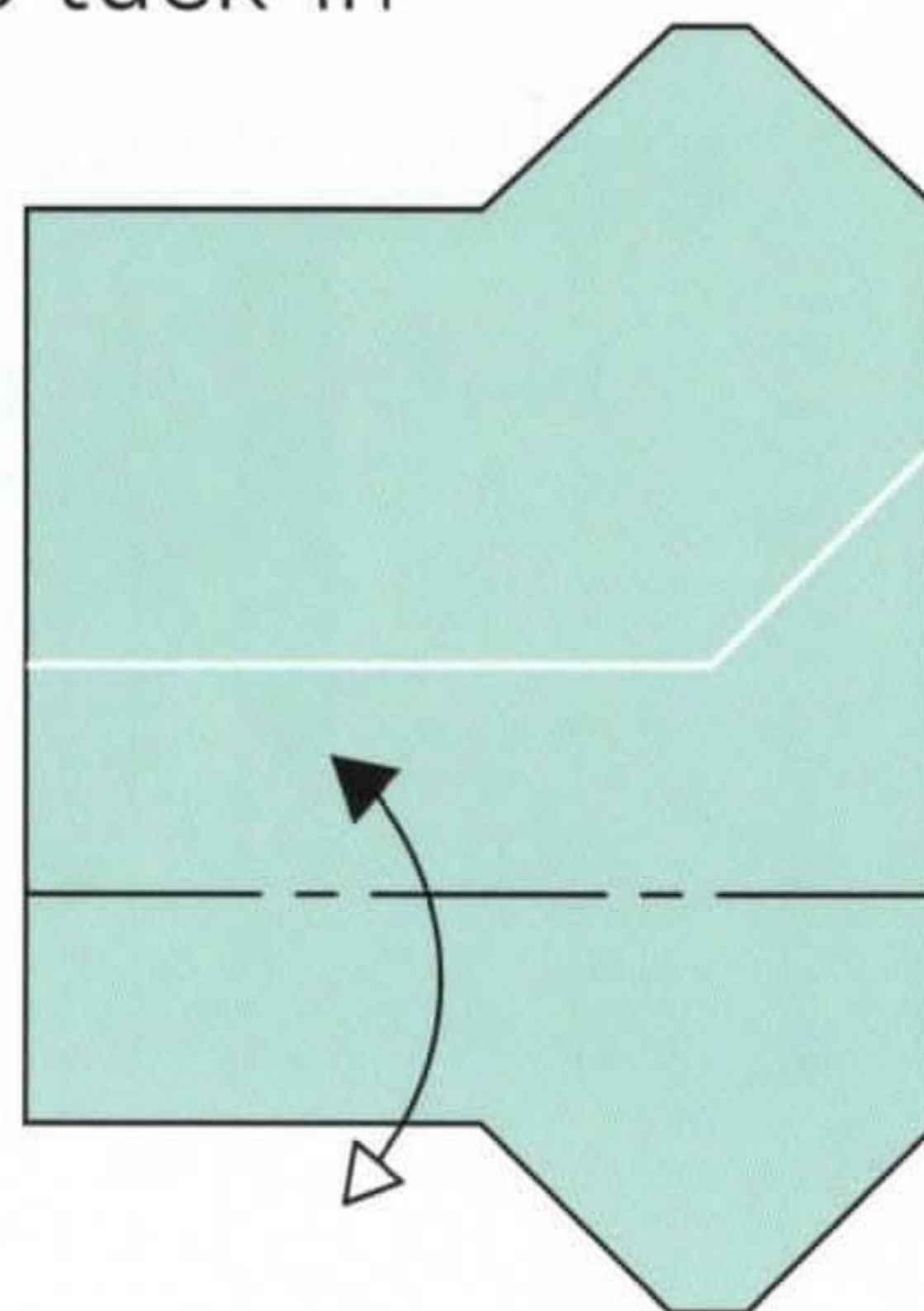

9. Mountain fold and unfold

couch: part 2

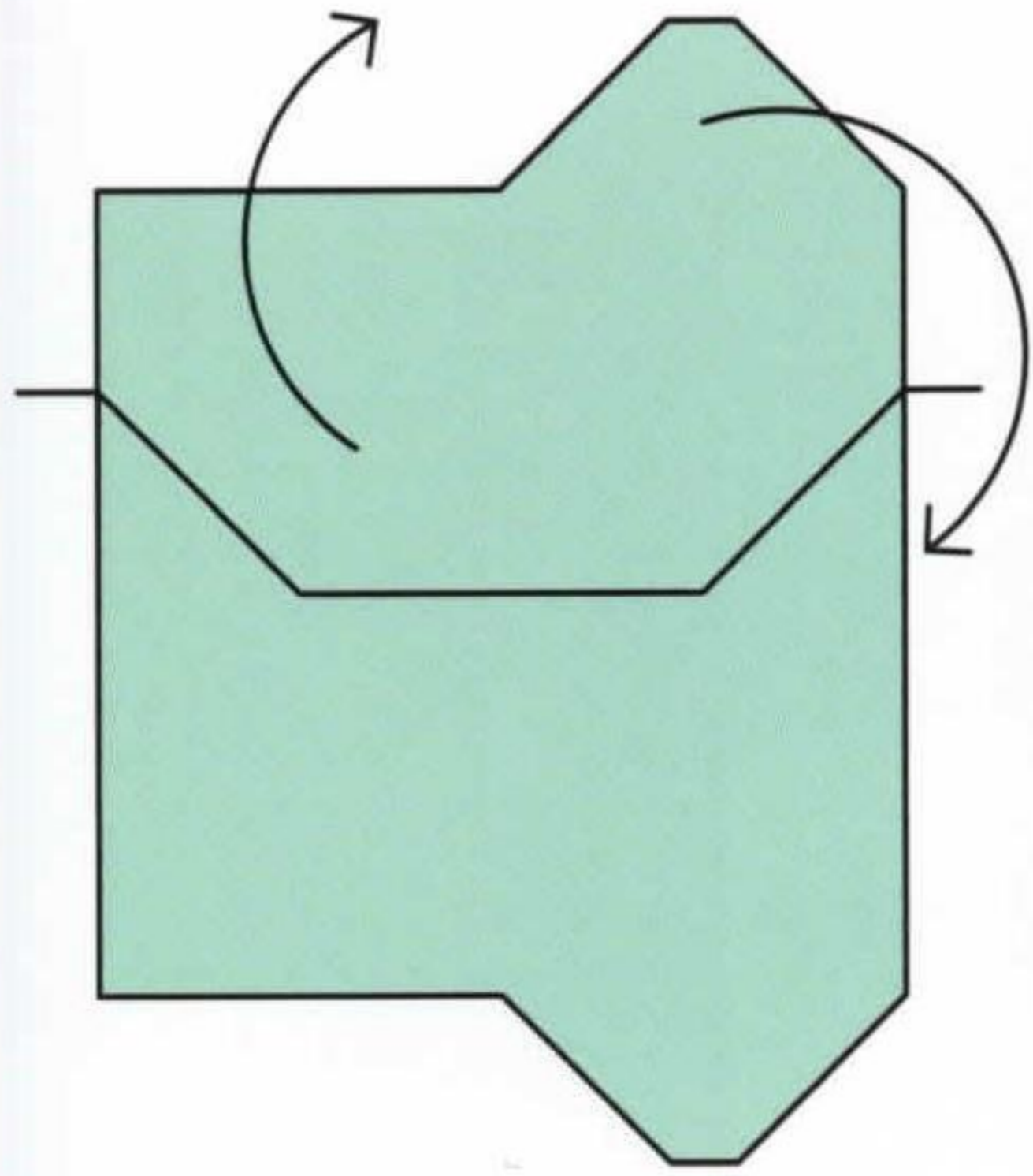

10. Flip upward

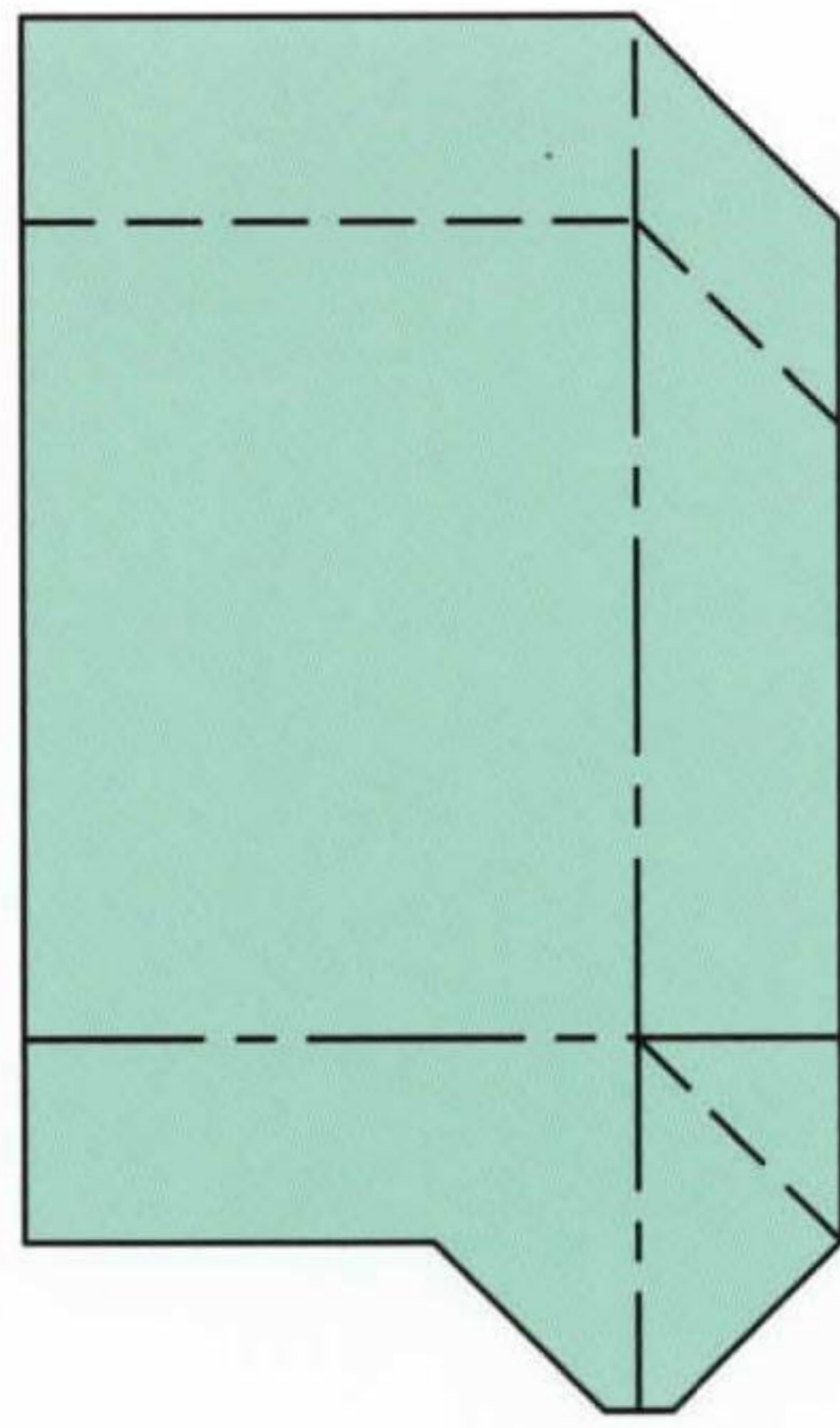

11. Fold along creased lines

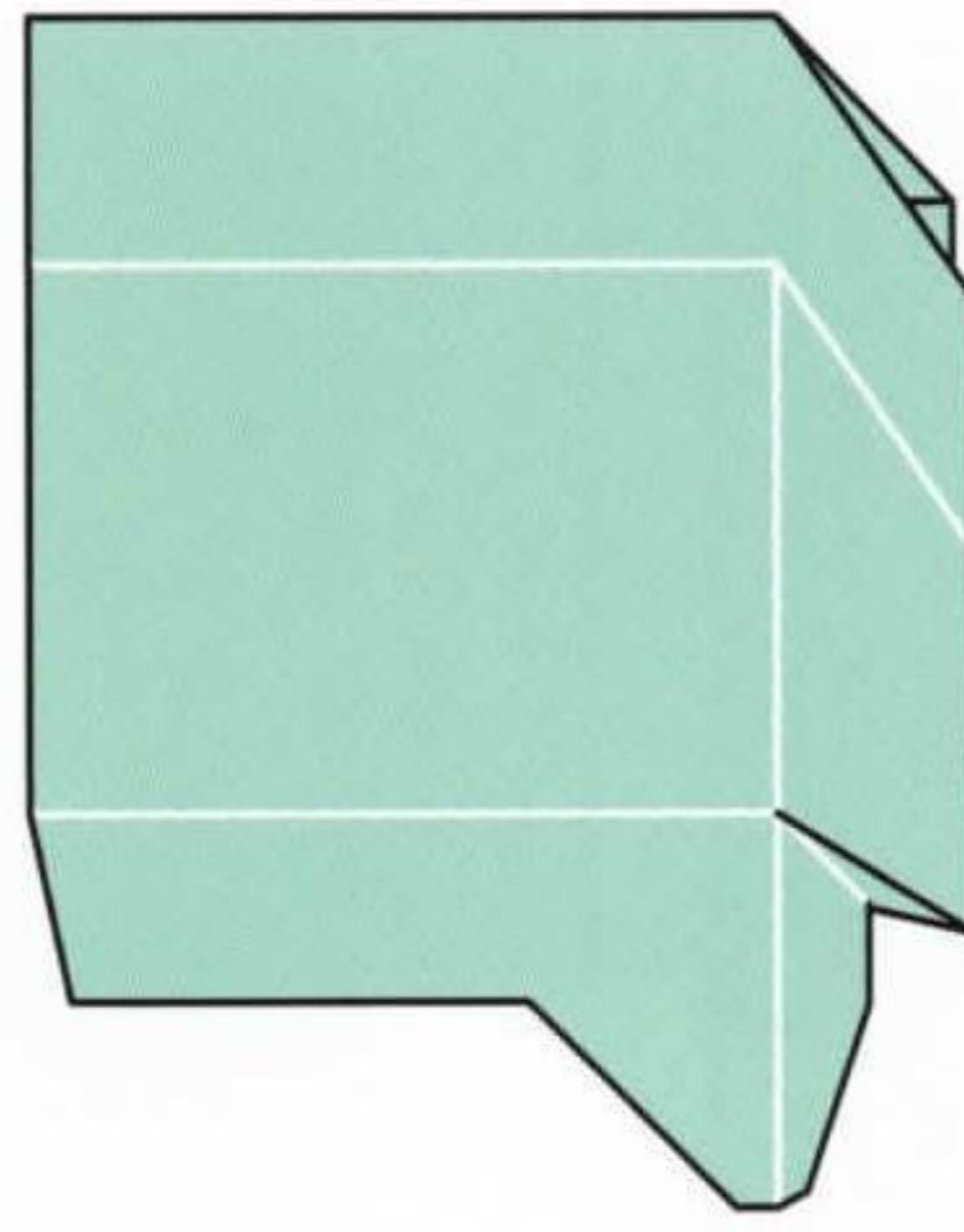

12. Before complete

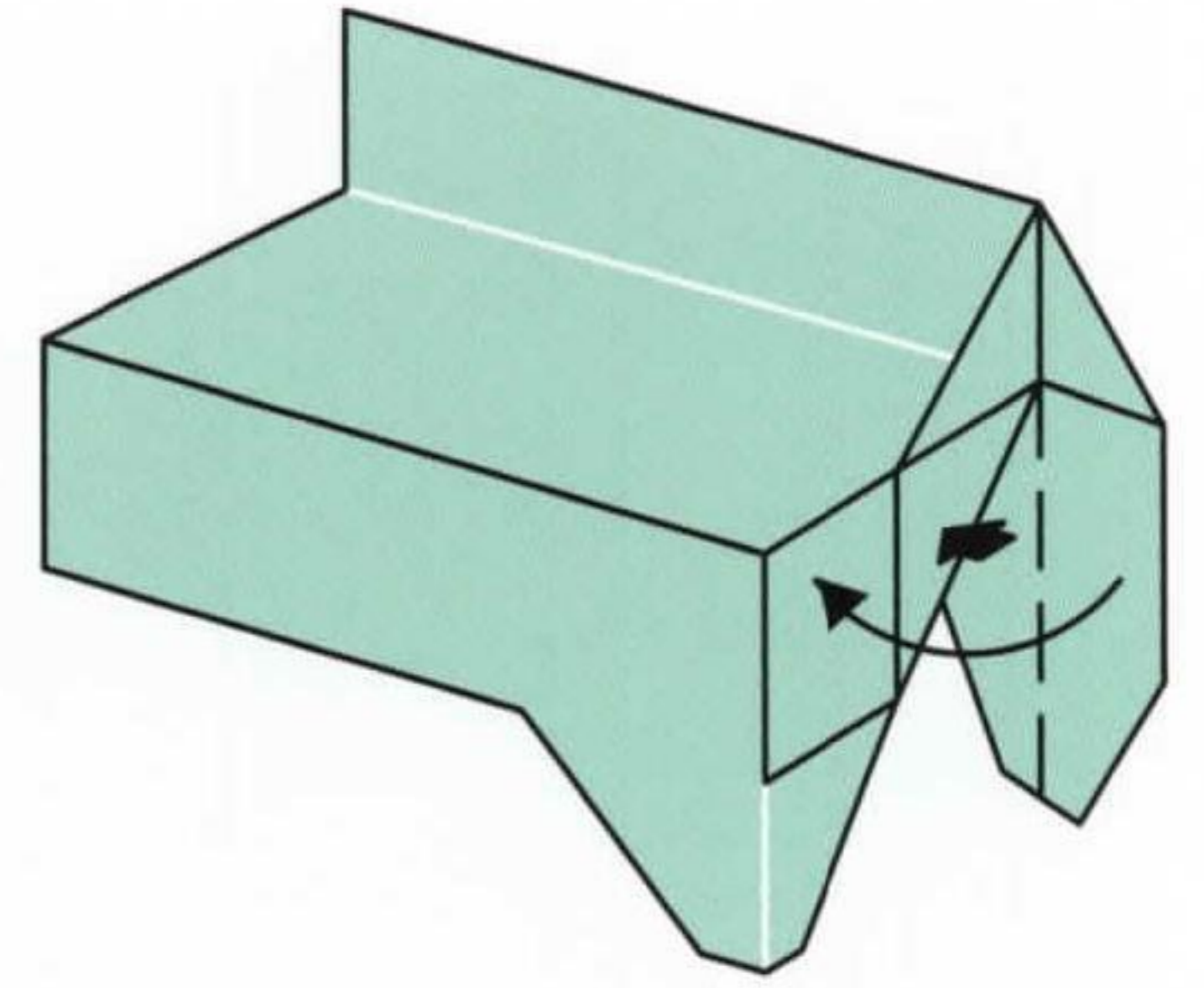

13. Valley fold and apply glue

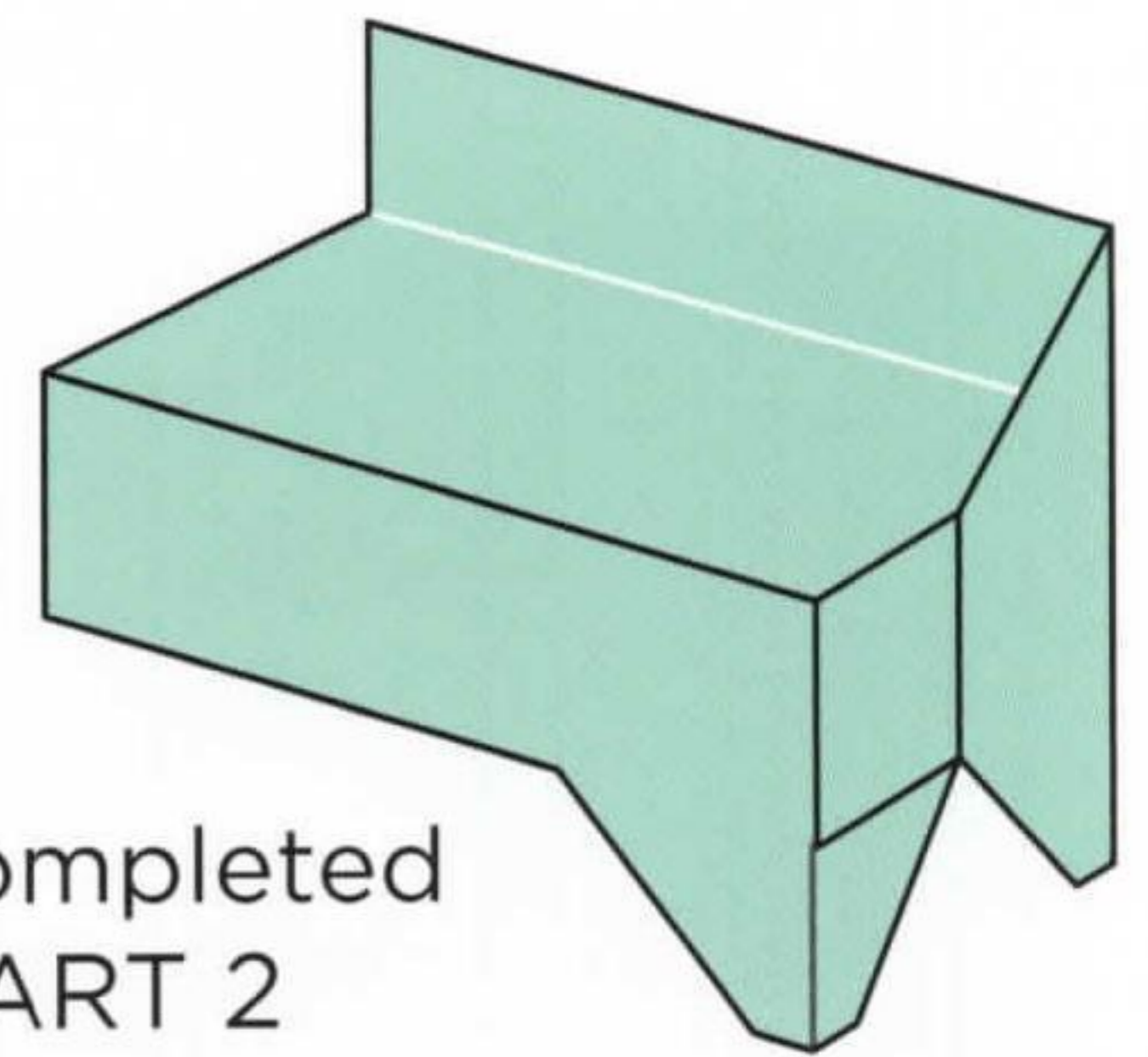

14. Completed PART 2

ASSEMBLY

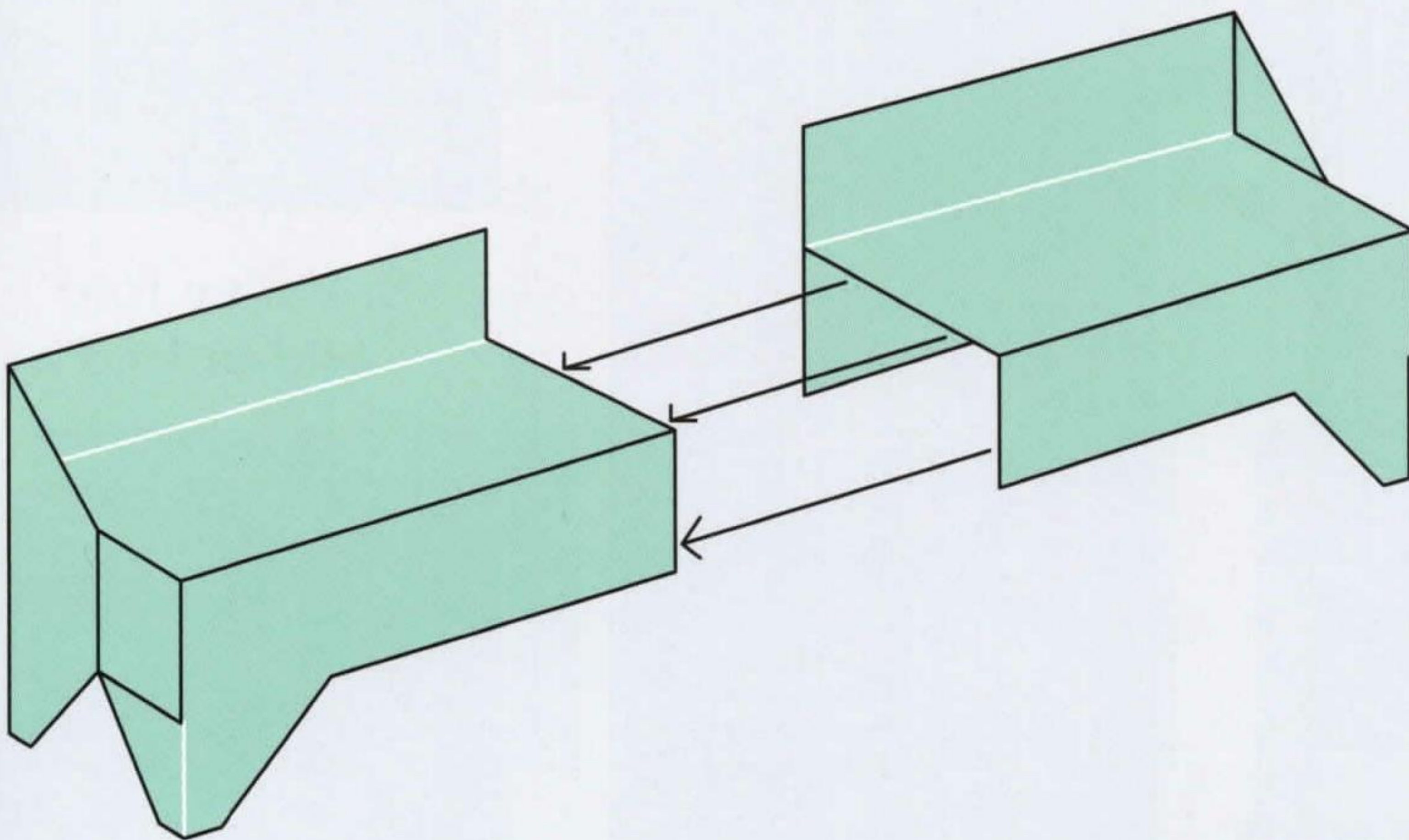

1. Insert Part 1 into Part 2 as the arrows indicate and apply glue

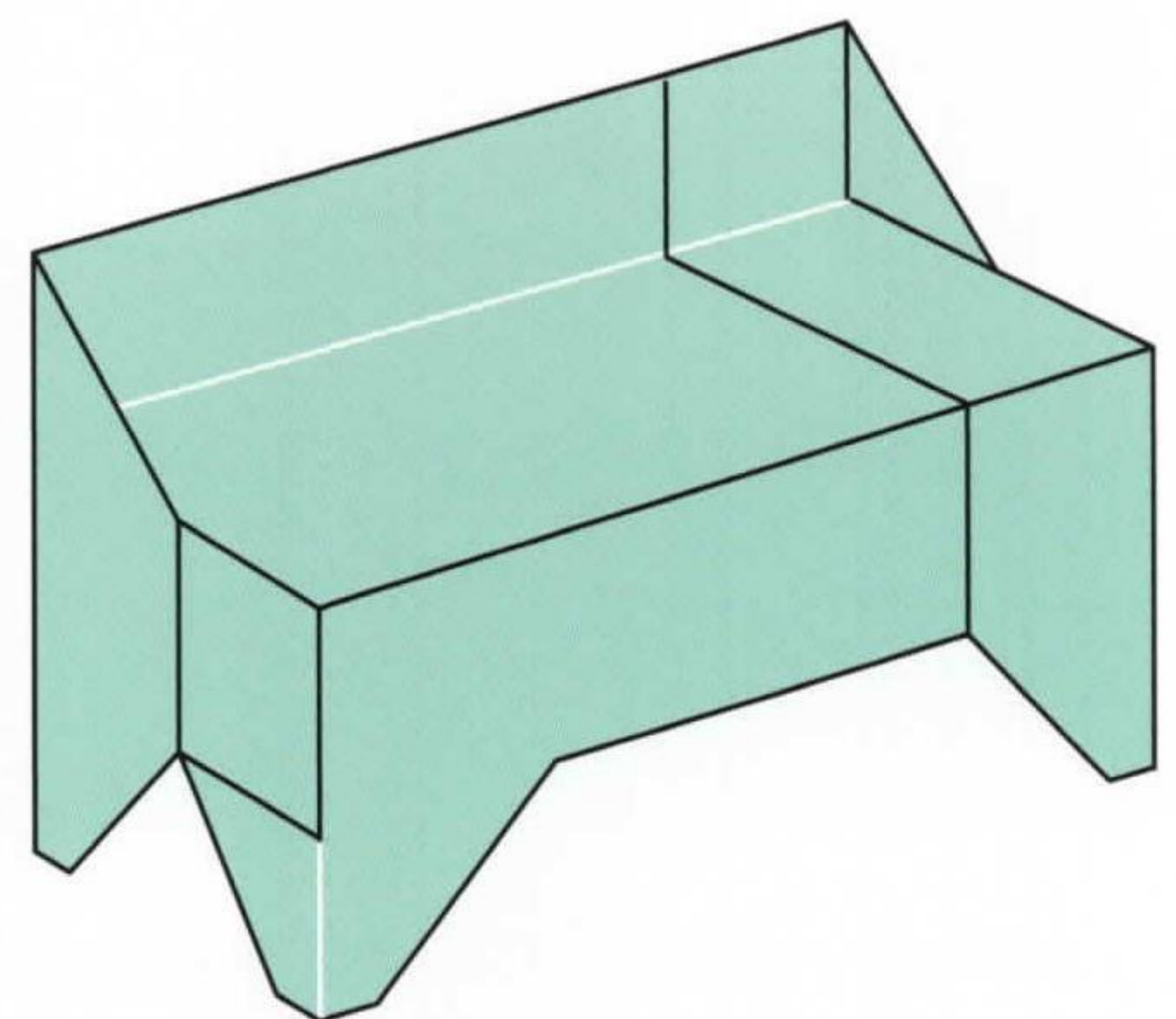

2. Completed COUCH

► end table

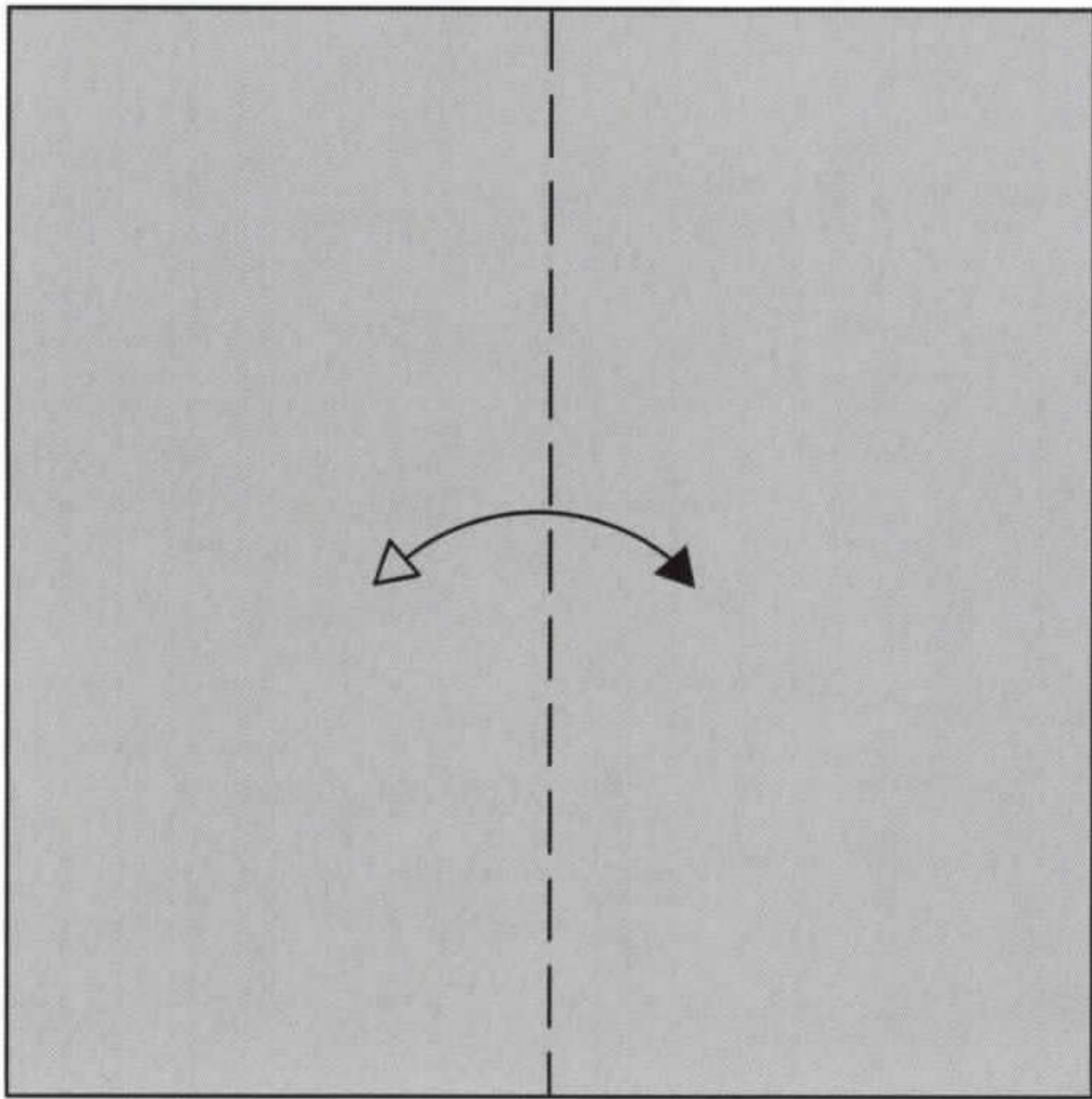

1. Valley fold and unfold

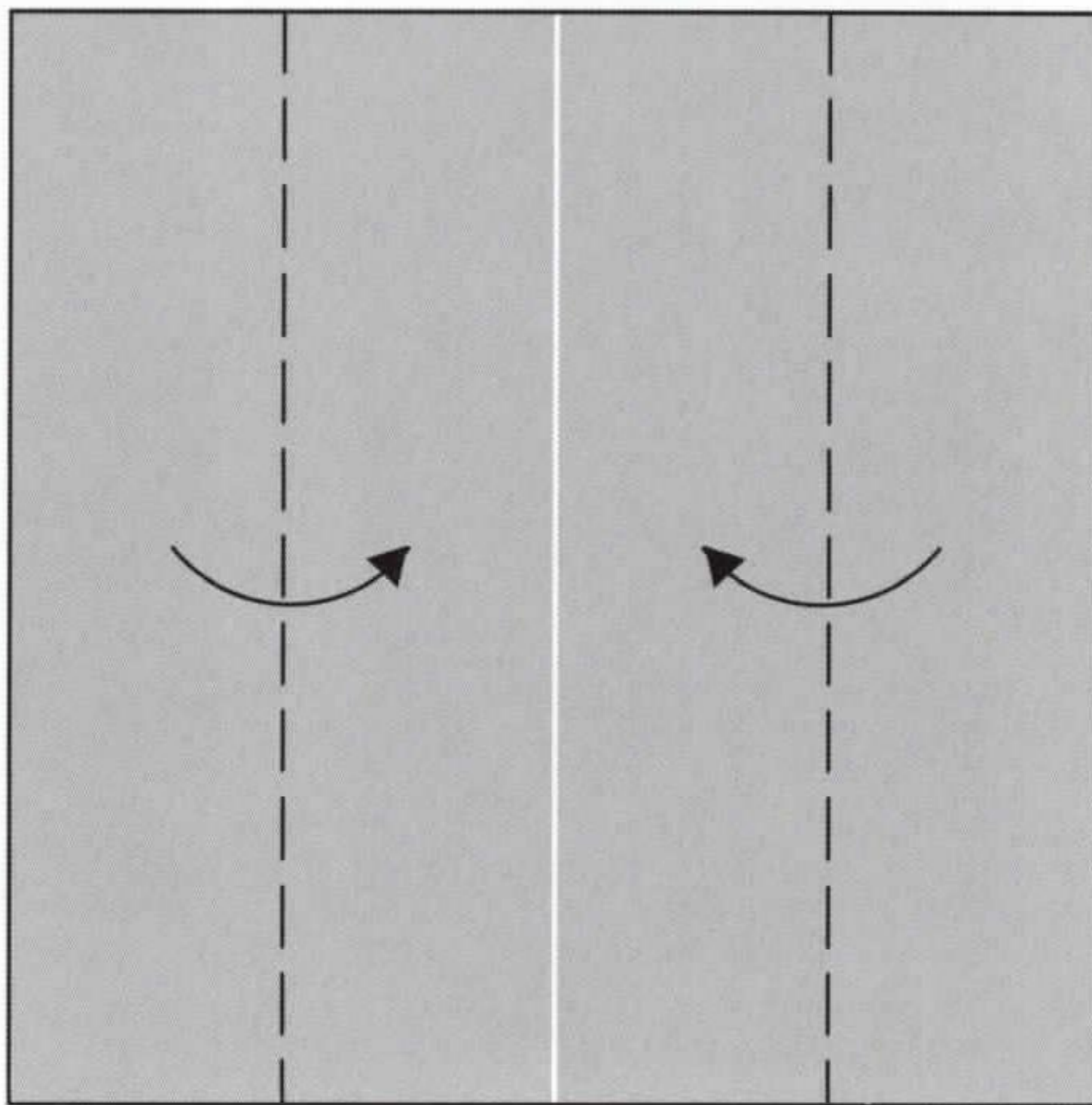

2. Valley folds

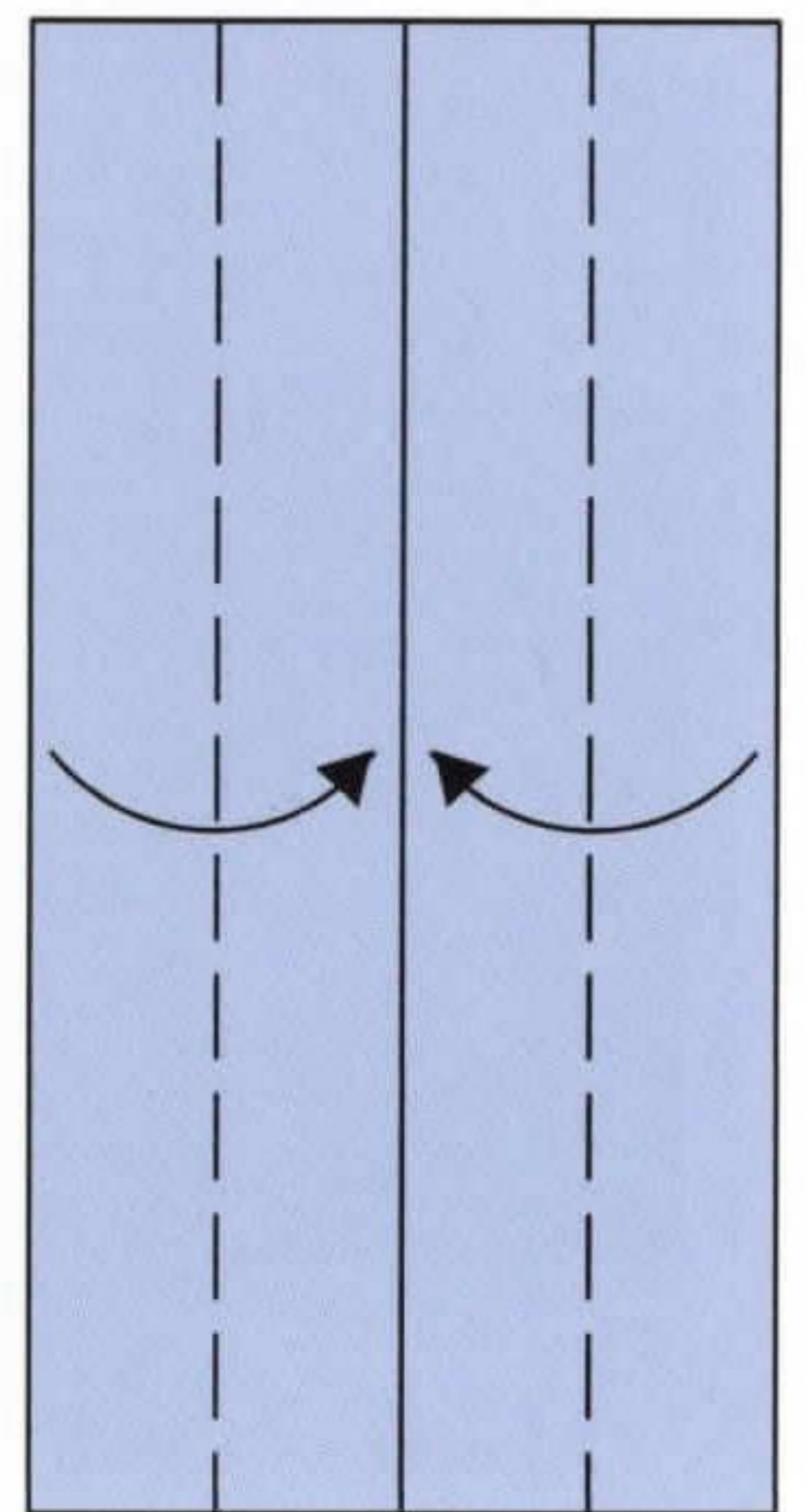

3. Valley folds

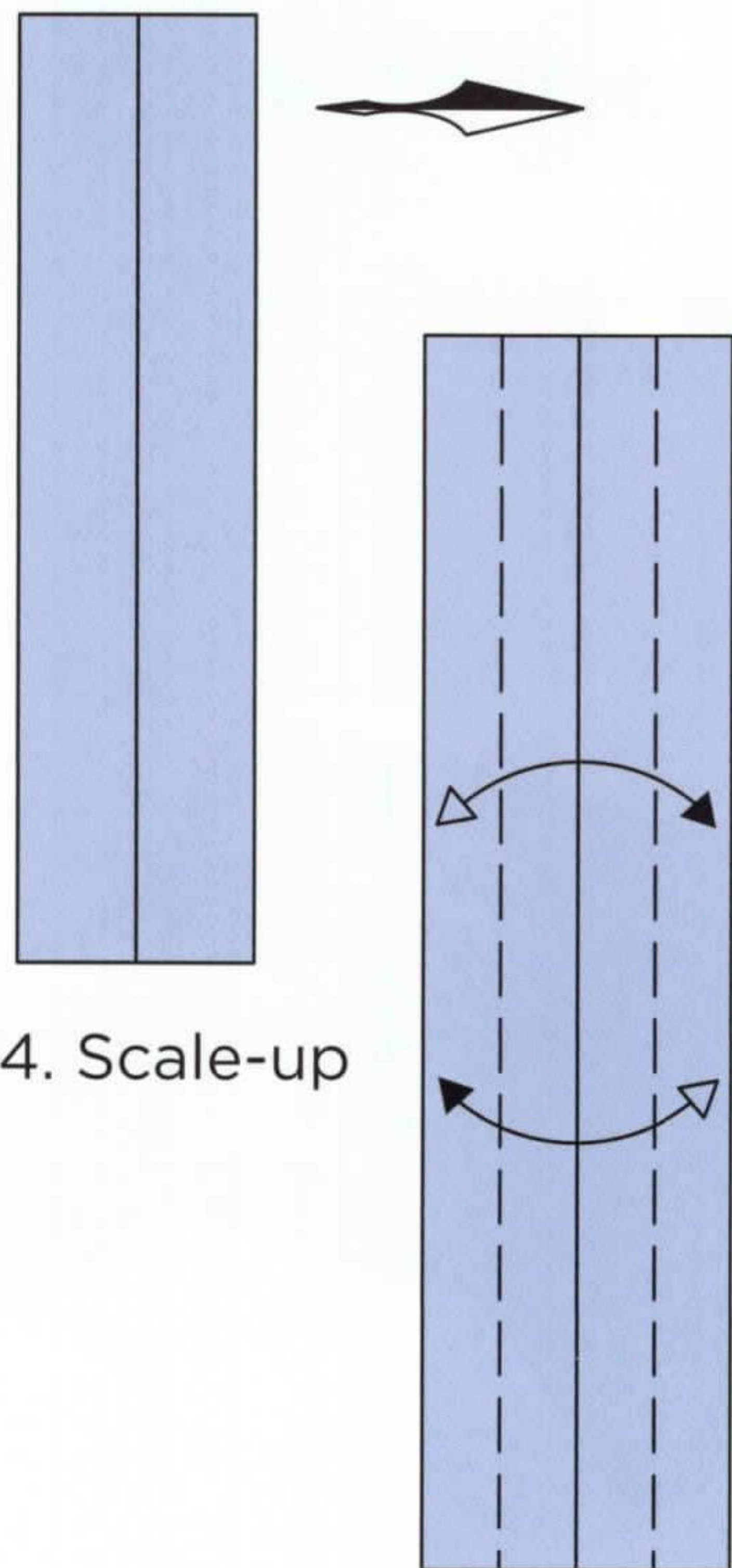

4. Scale-up

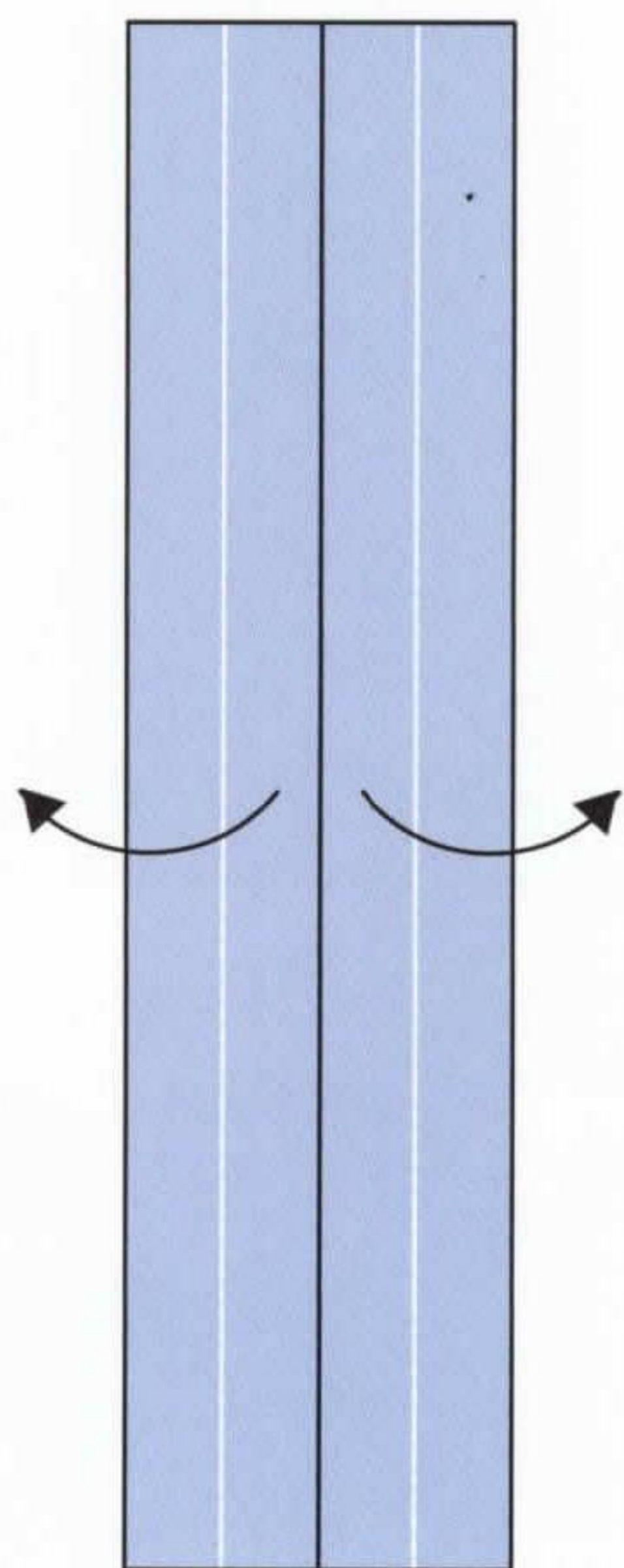

5. Valley folds and unfold

6. Valley folds

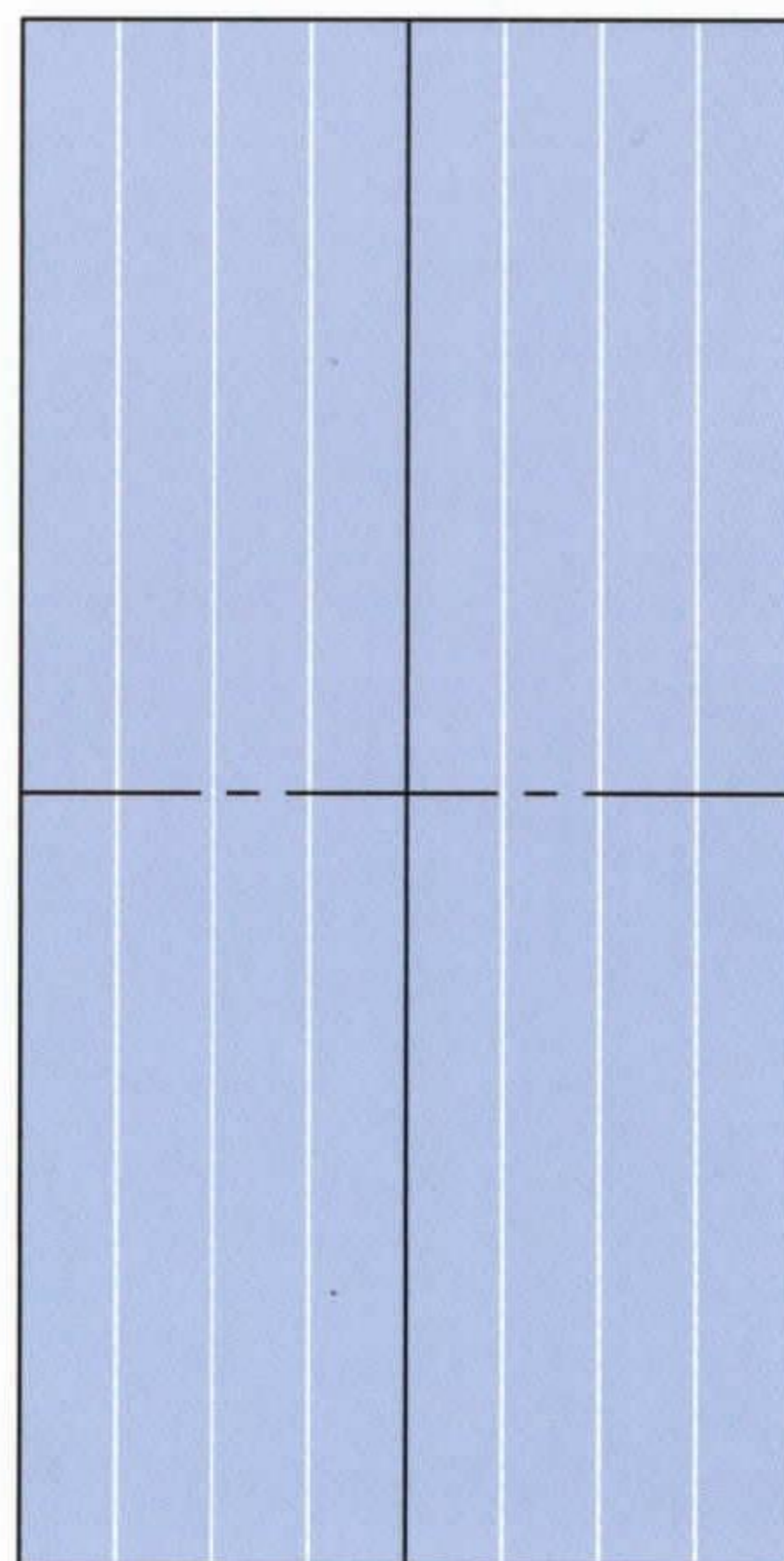

7. Mountain fold

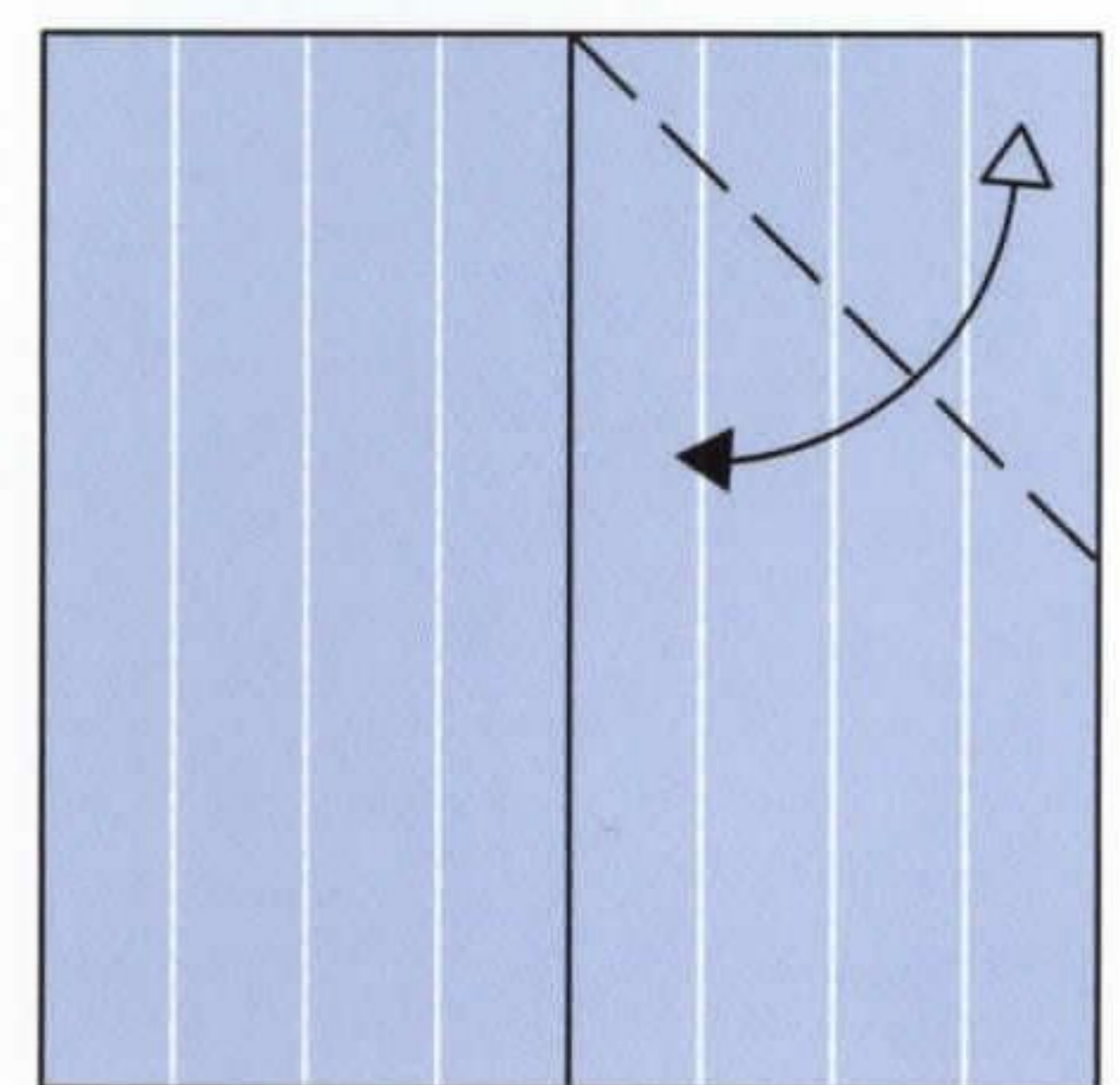

8. Valley fold and unfold

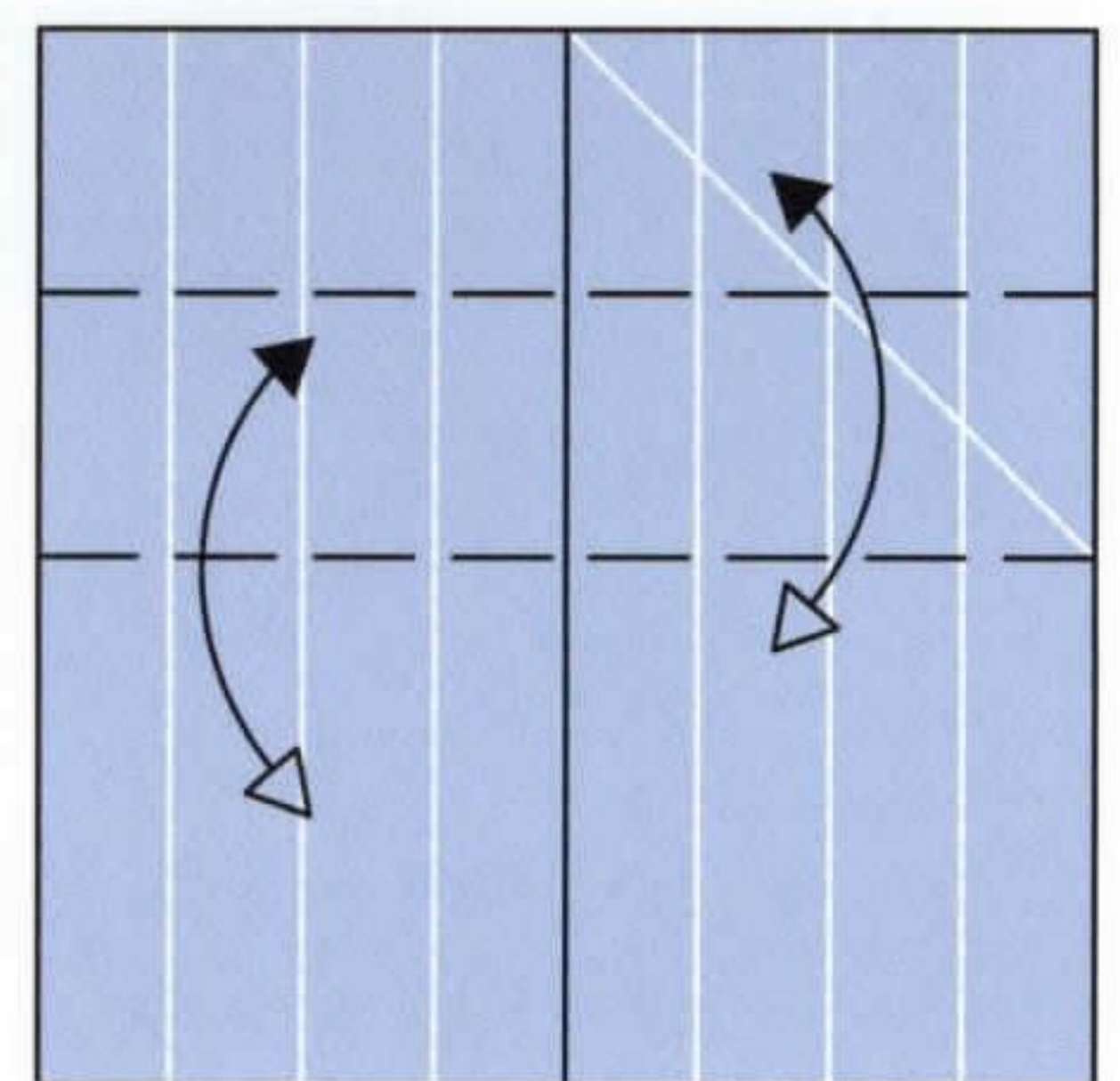

9. Repeat

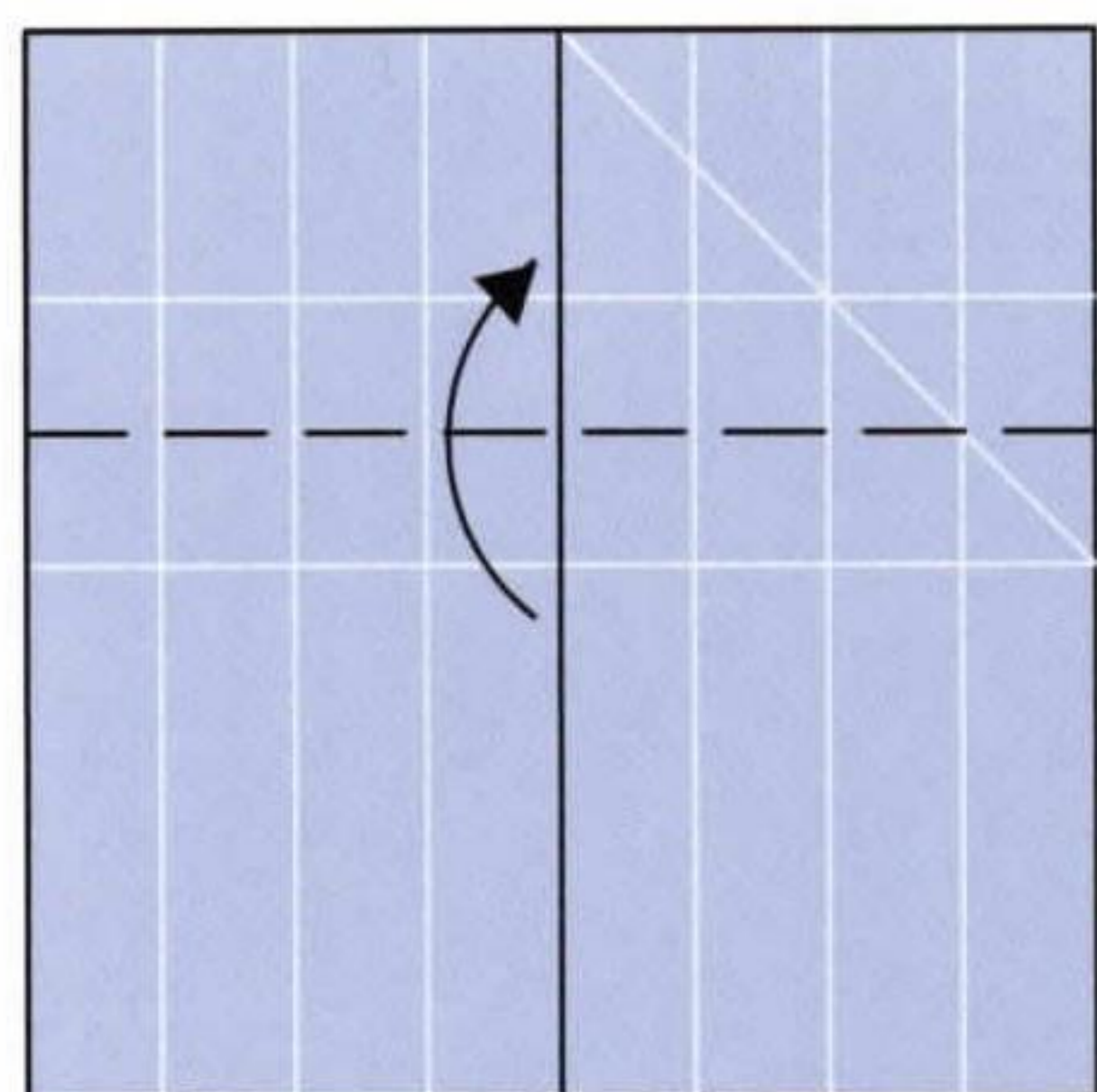

10. Valley fold

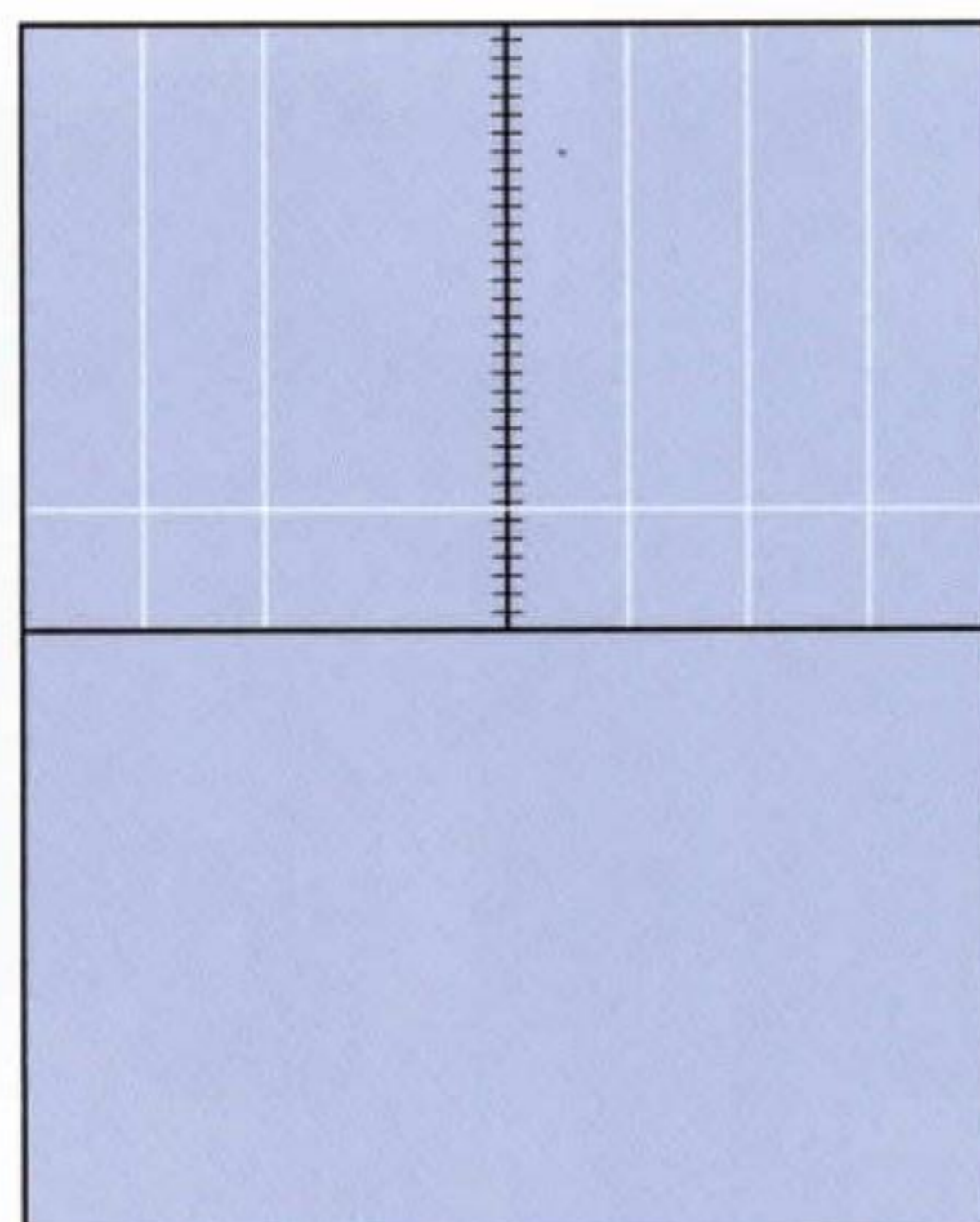

11. Cut as shown

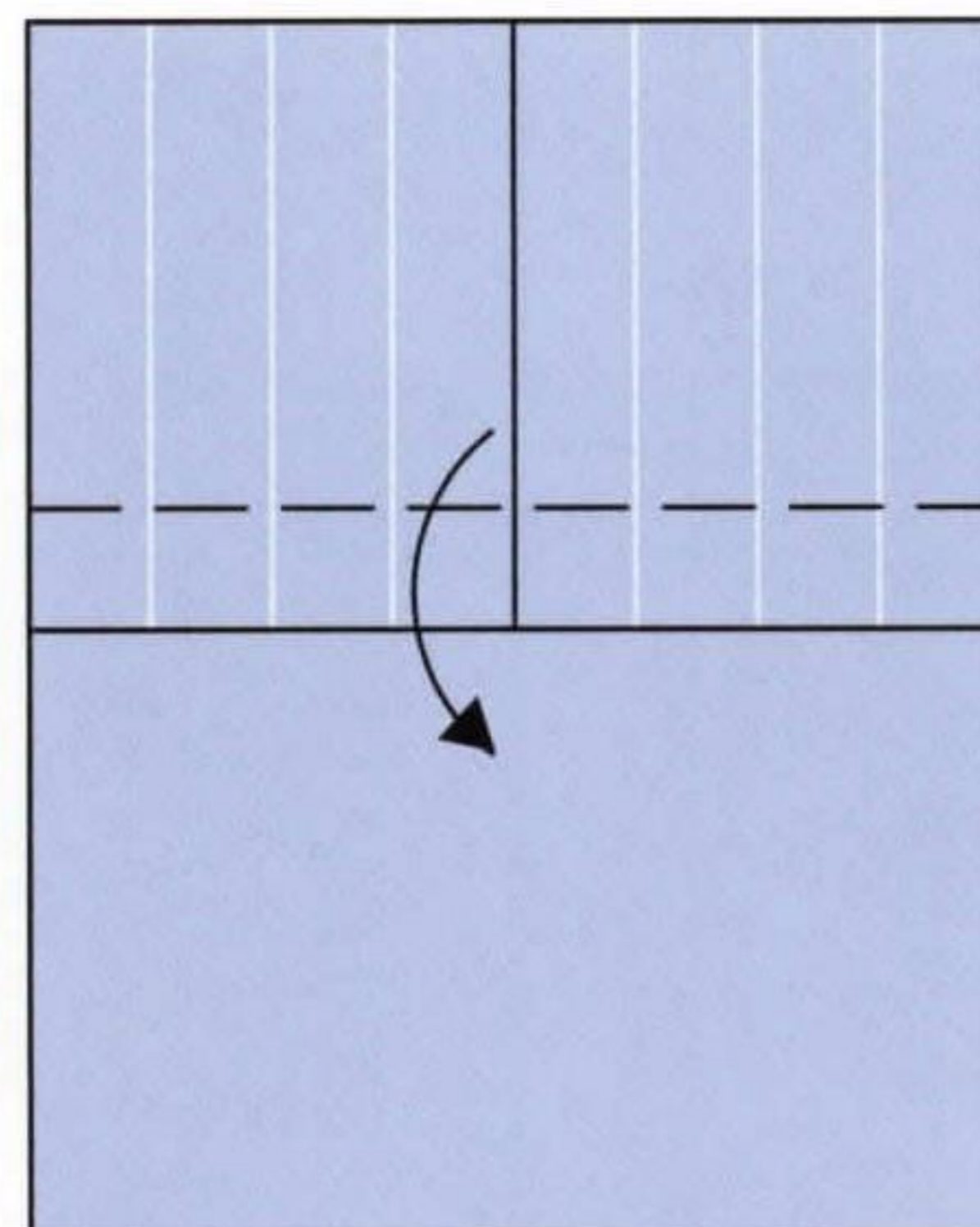

12. Valley folds

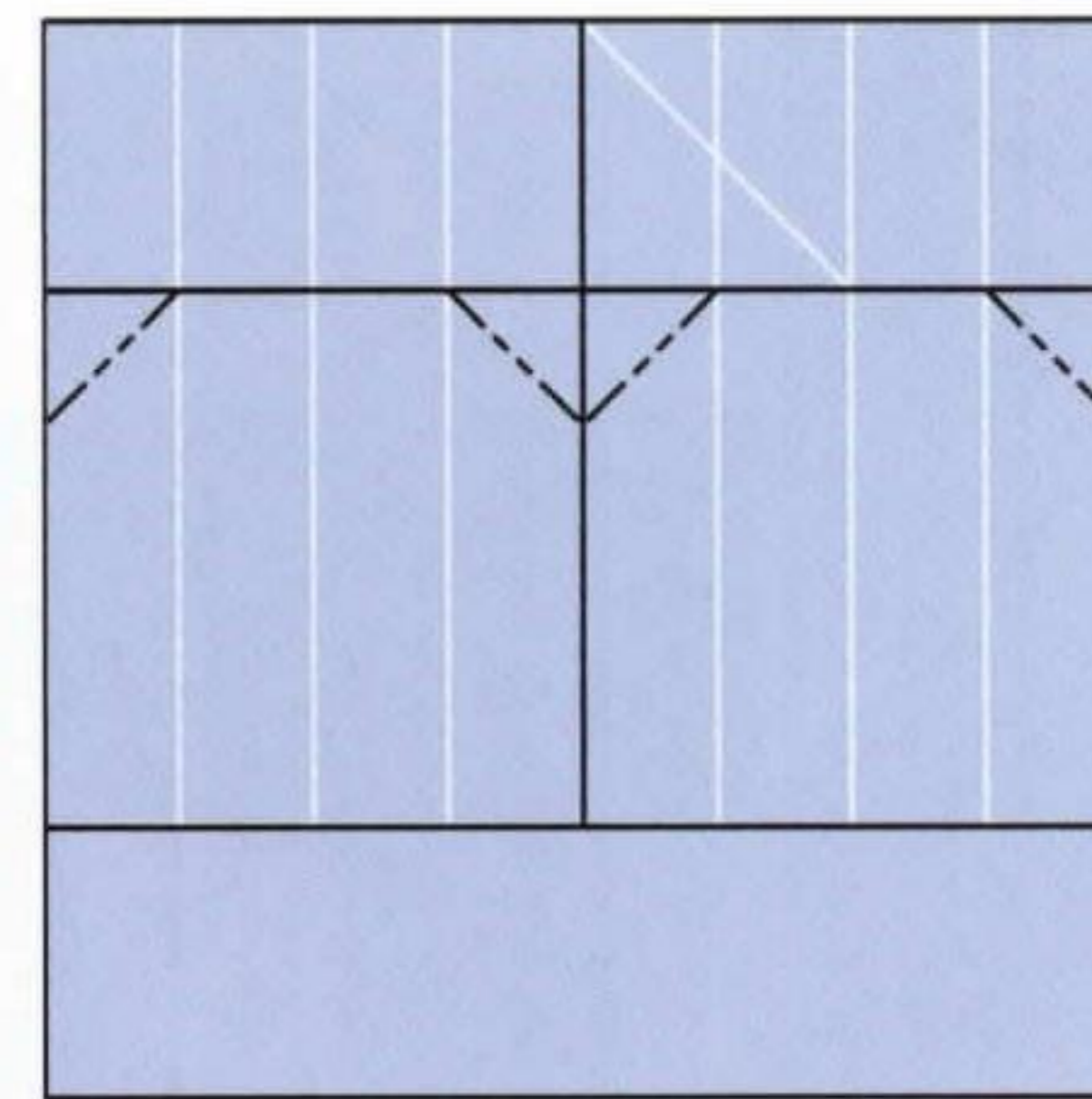

13. Inside reverse folds

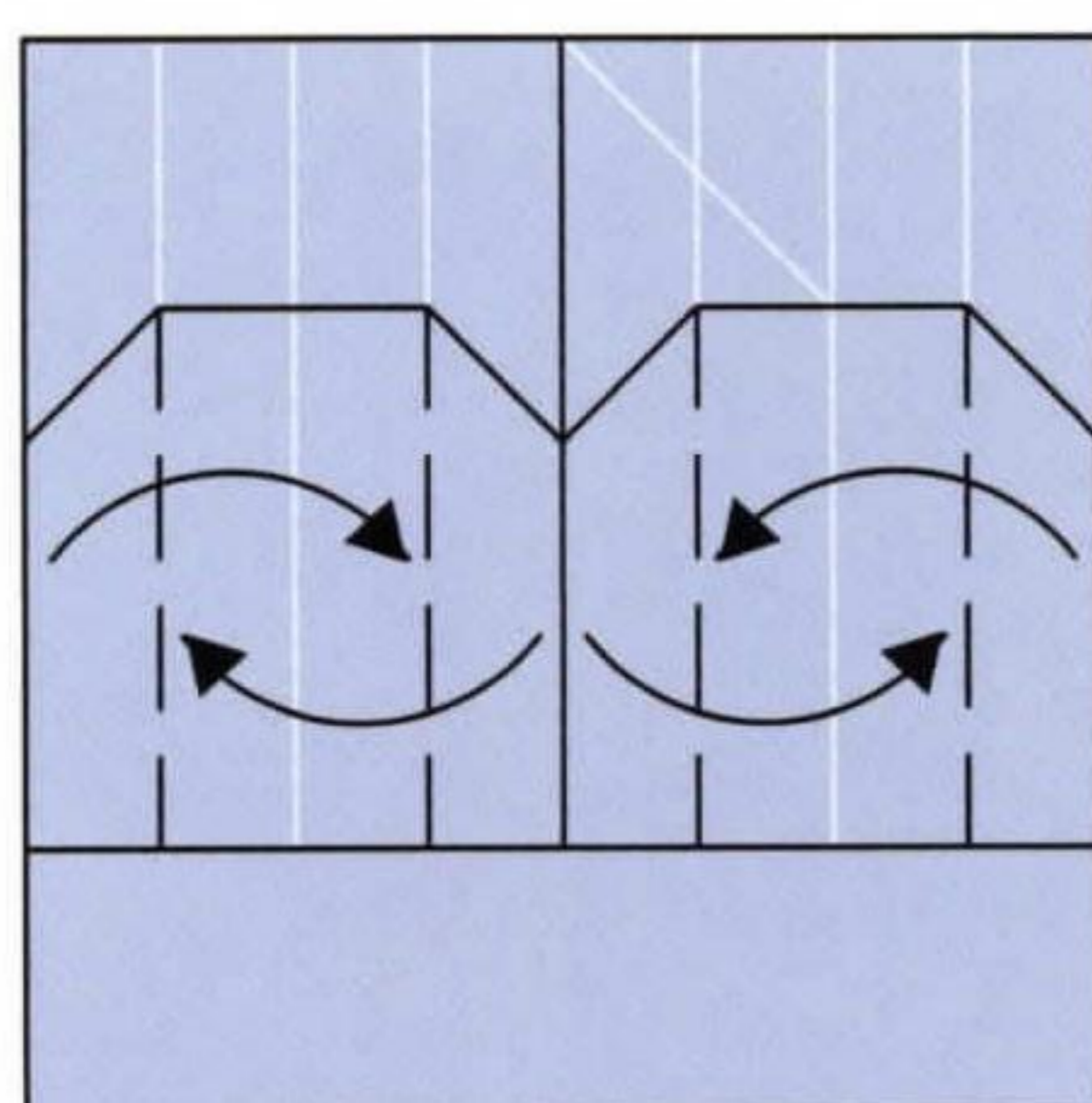

14. Valley folds

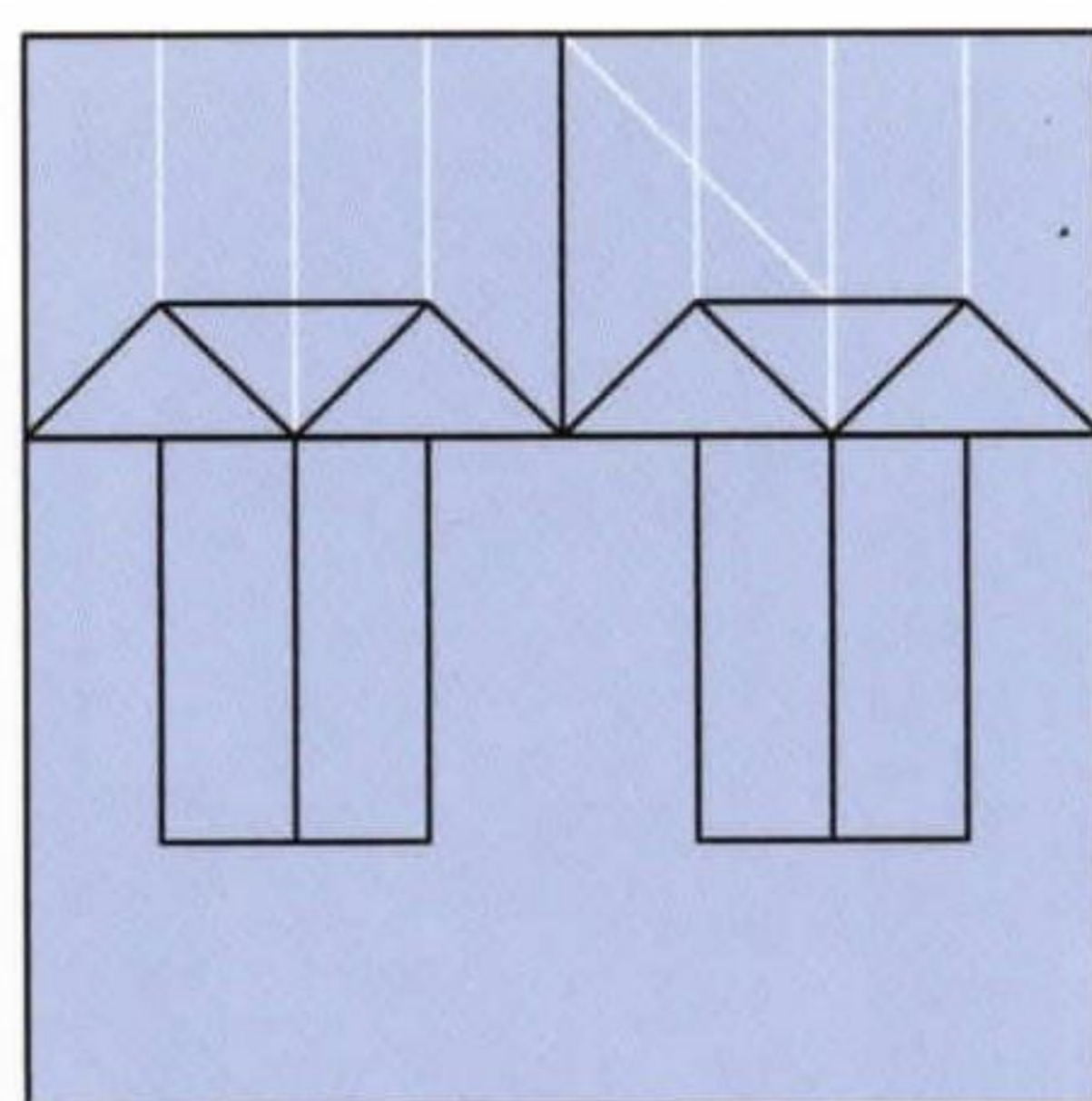

15. Turn over

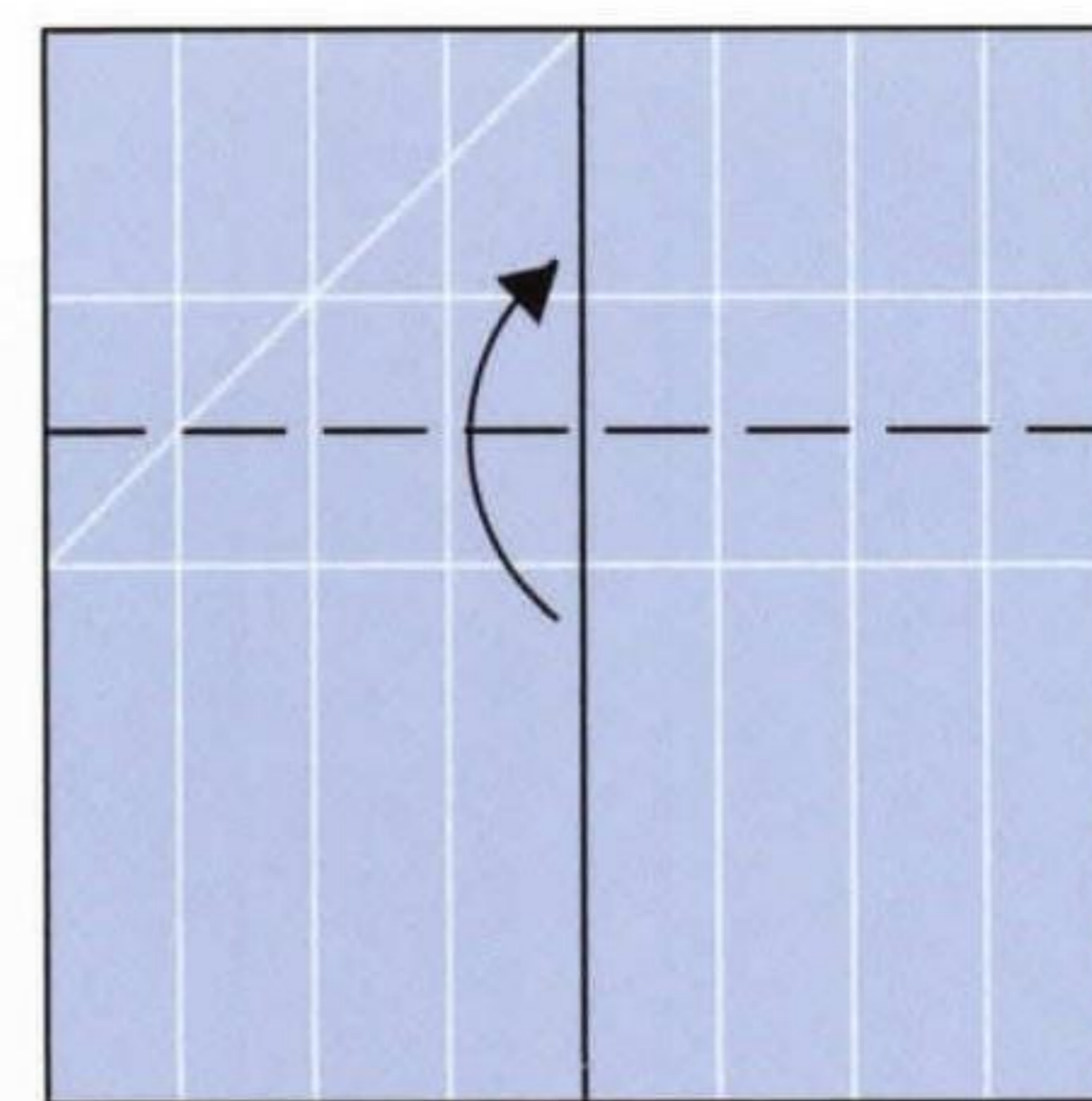

16. Valley fold

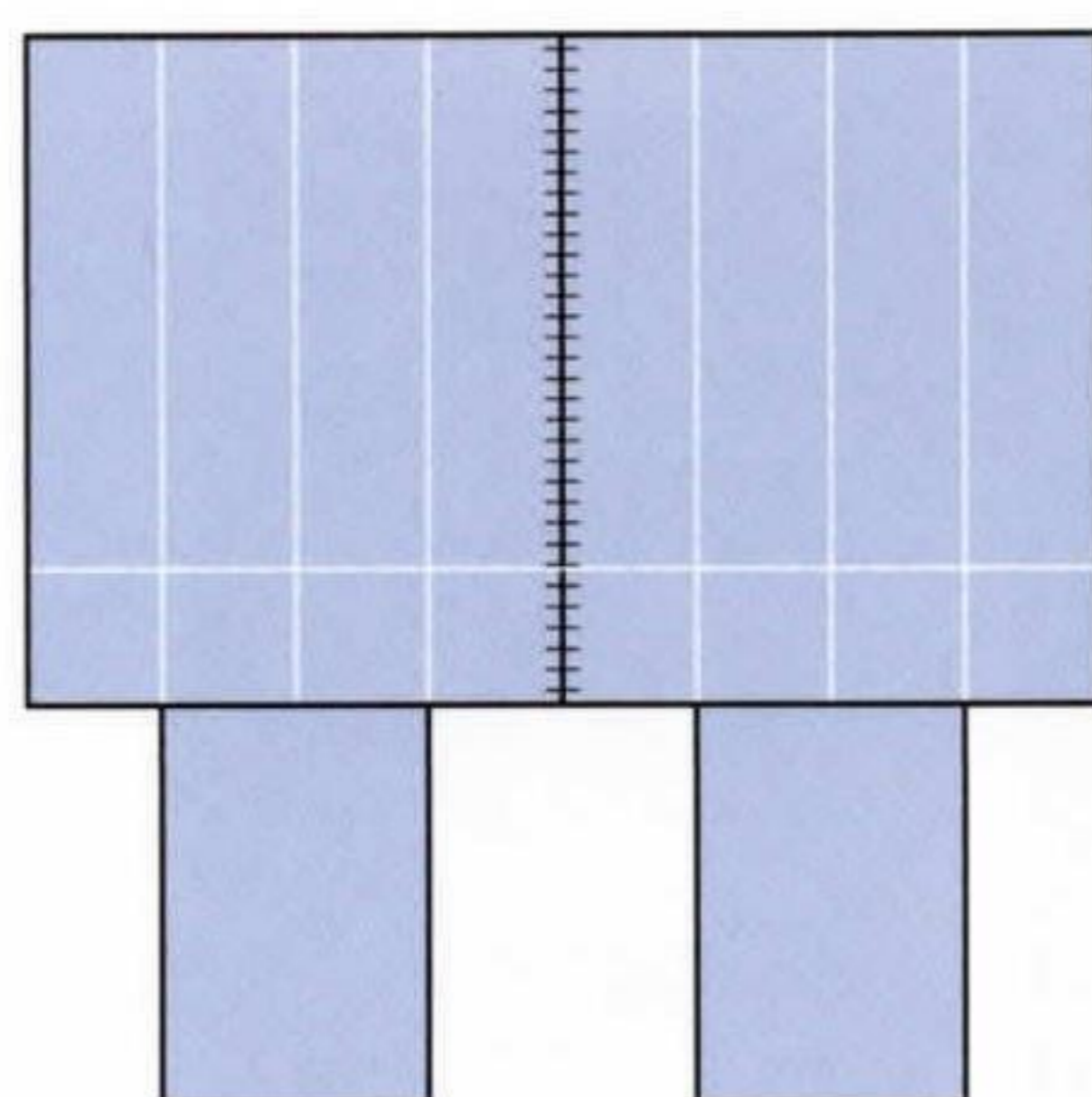

17. Cut as shown

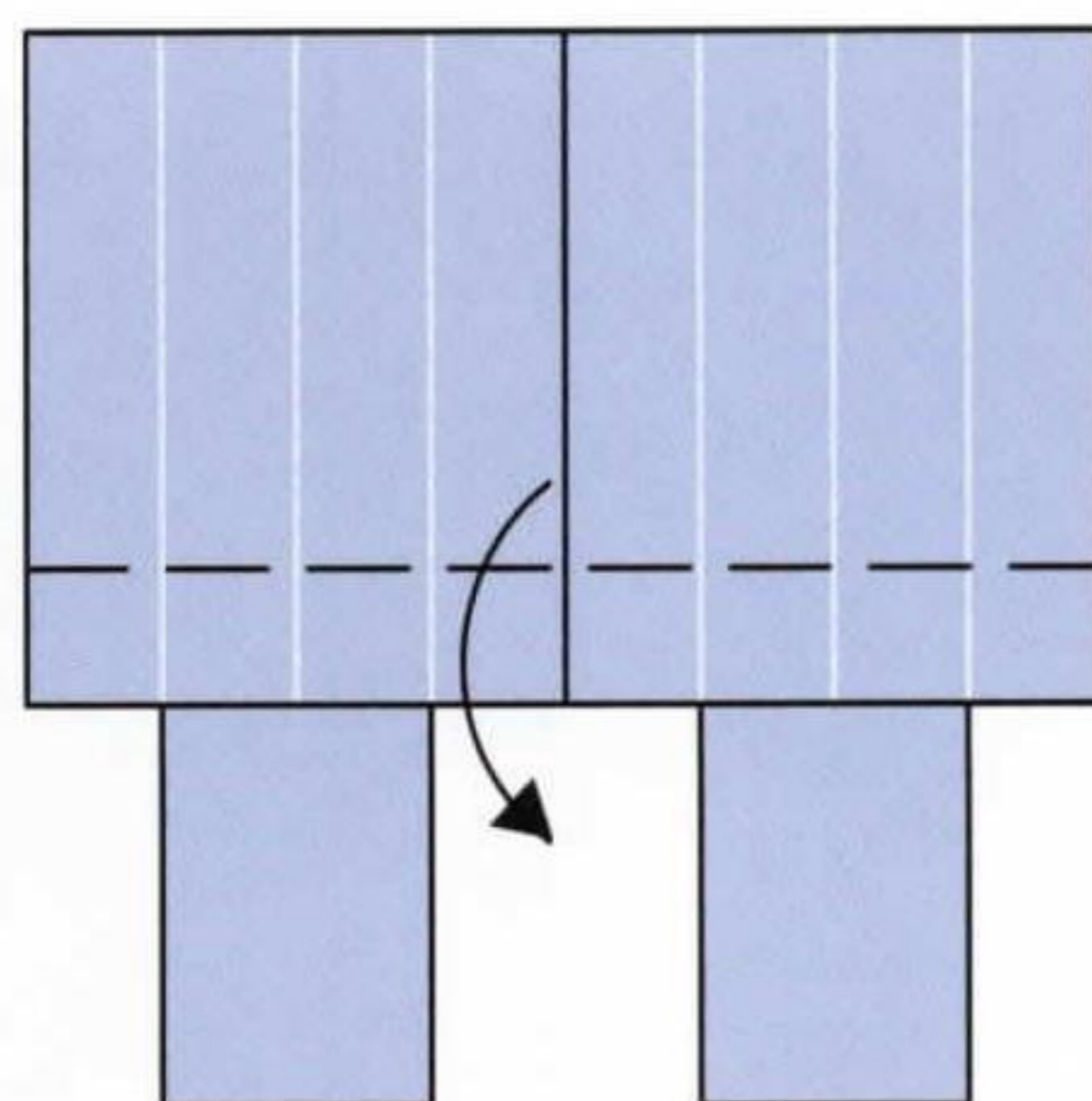

18. Valley fold

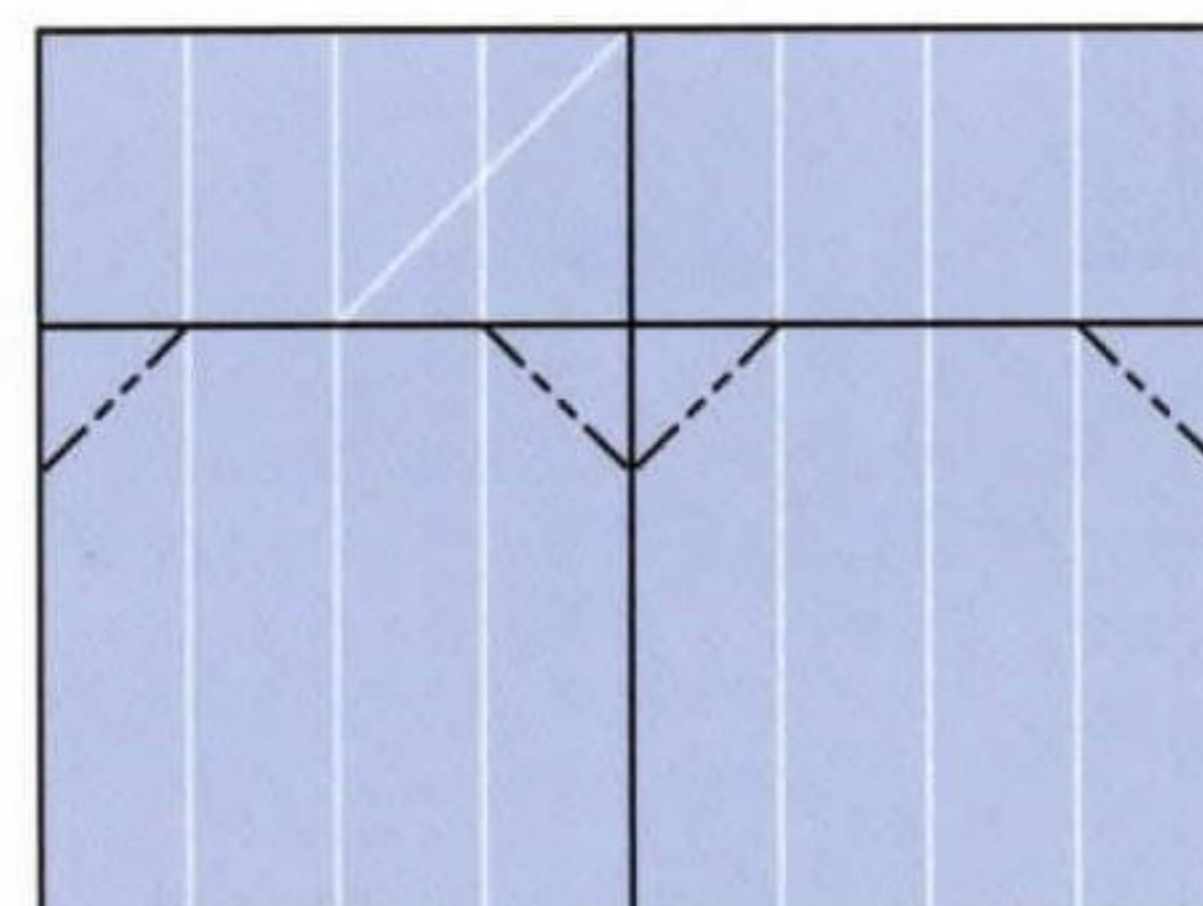

19. Inside reverse folds

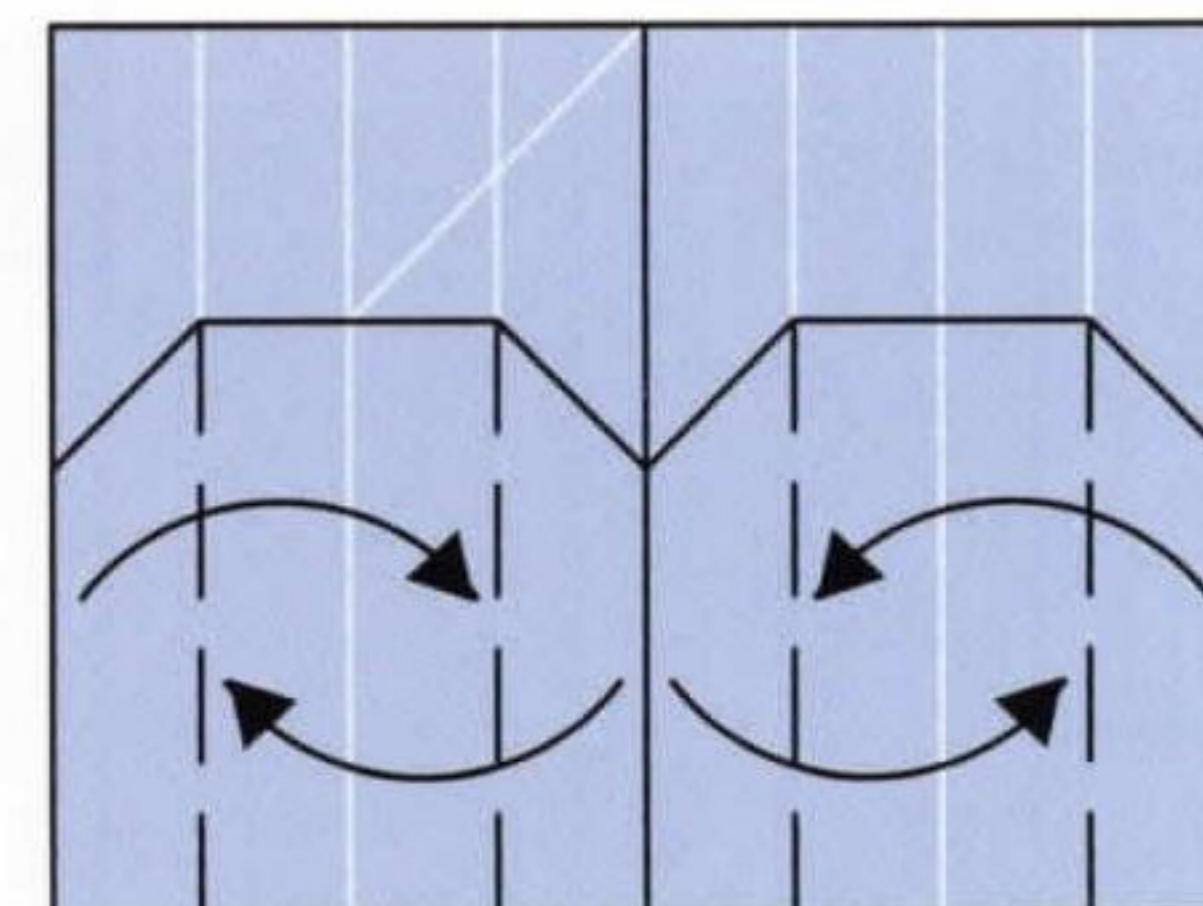

20. Valley folds

end table

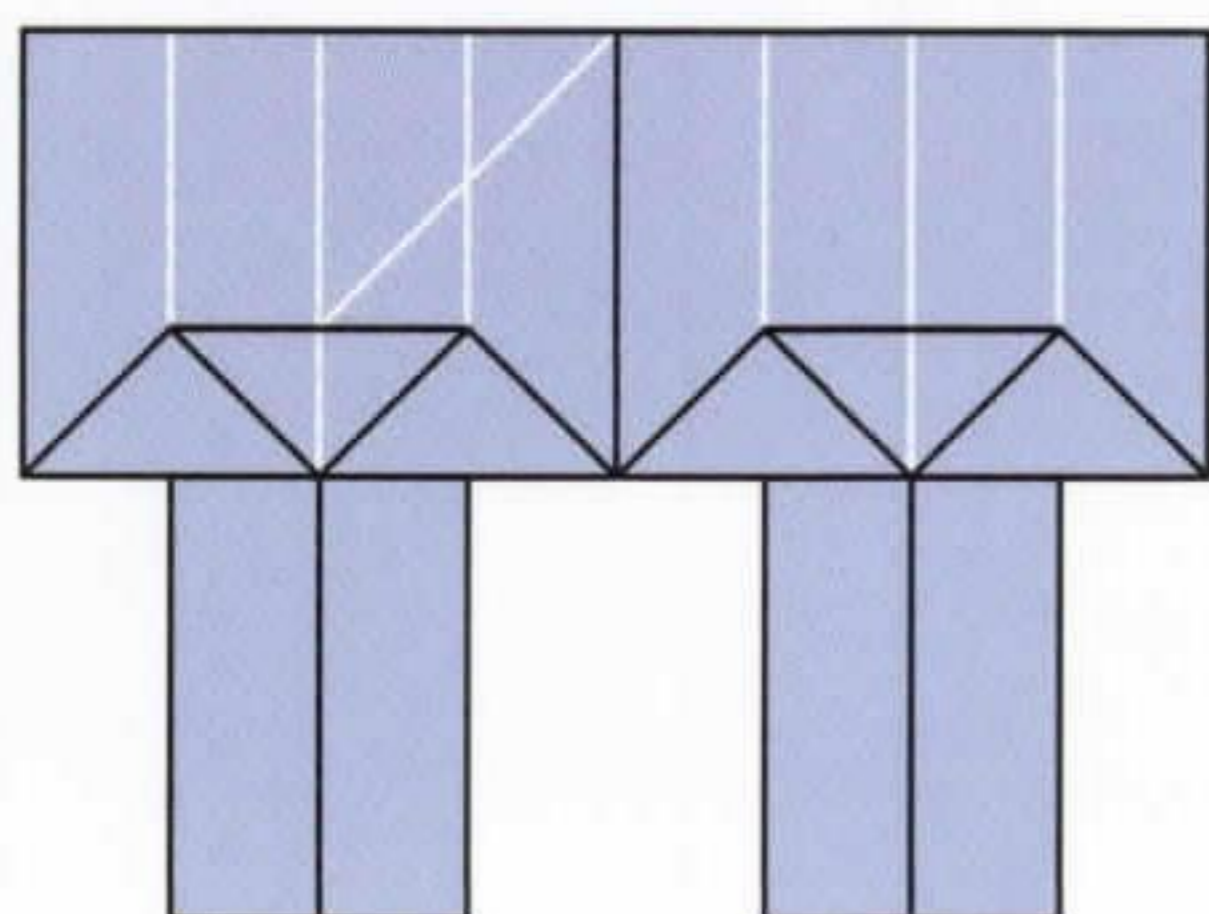

21. Valley fold to open

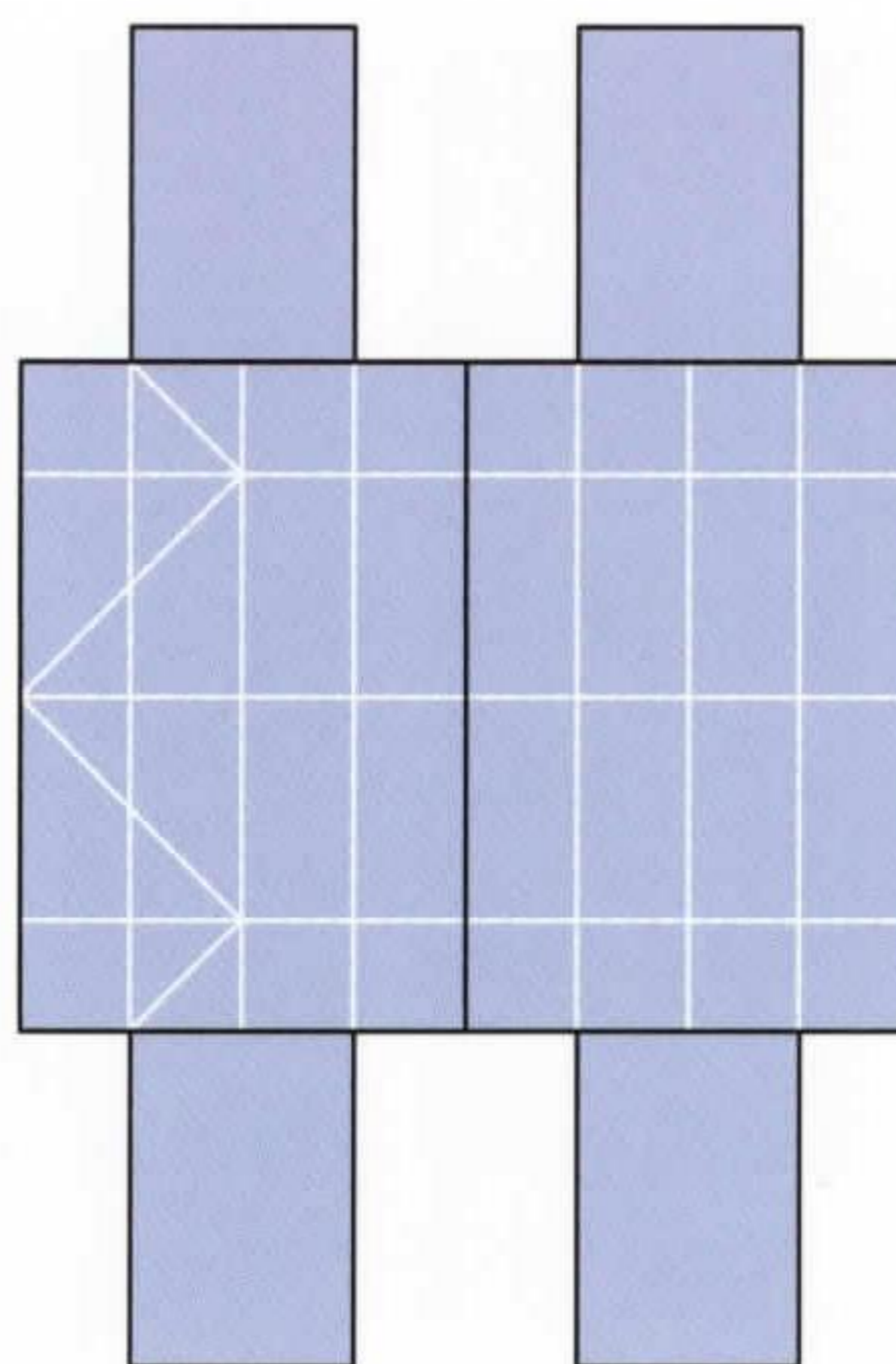

22. Turn over

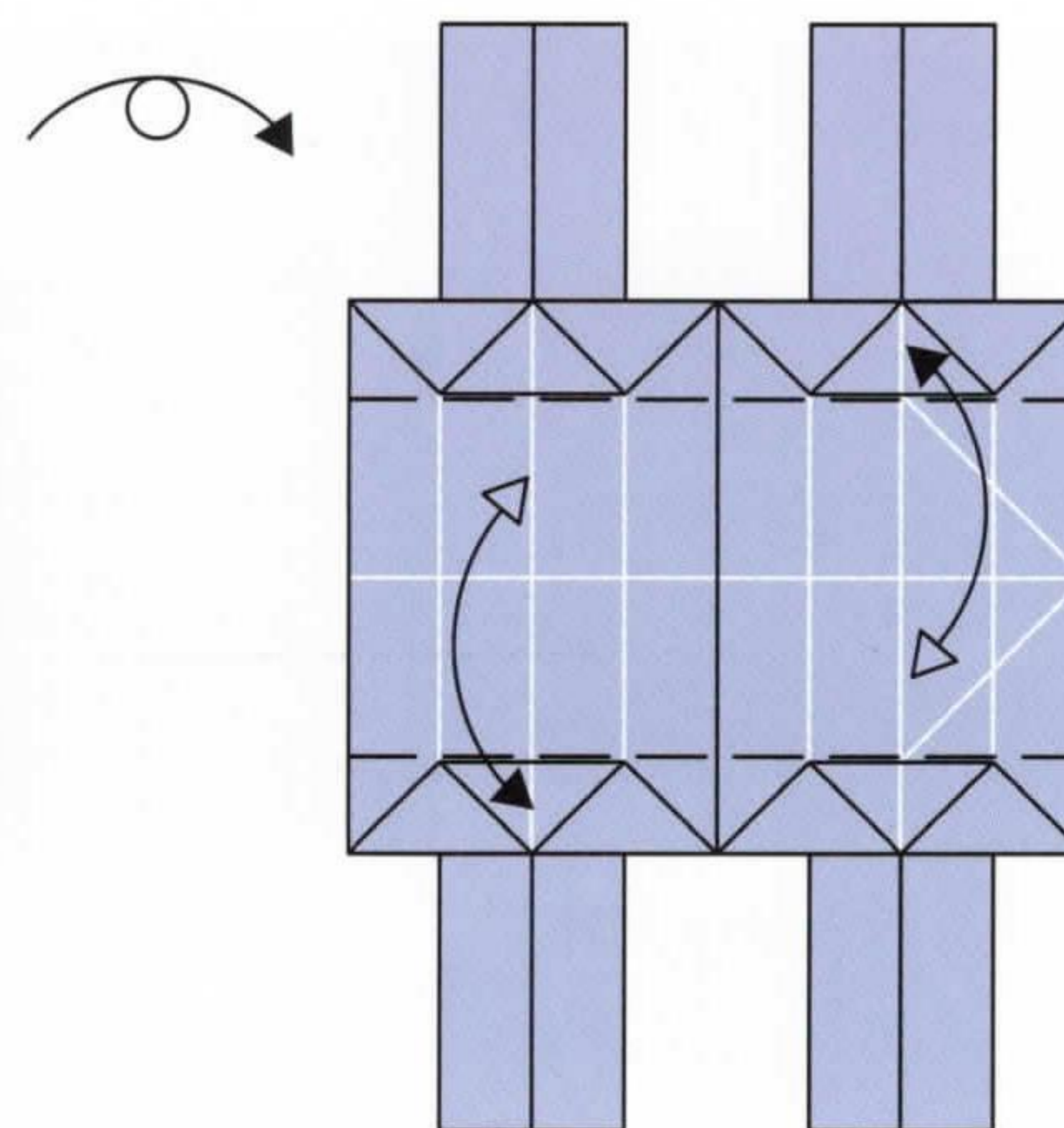

23. Valley fold and unfold

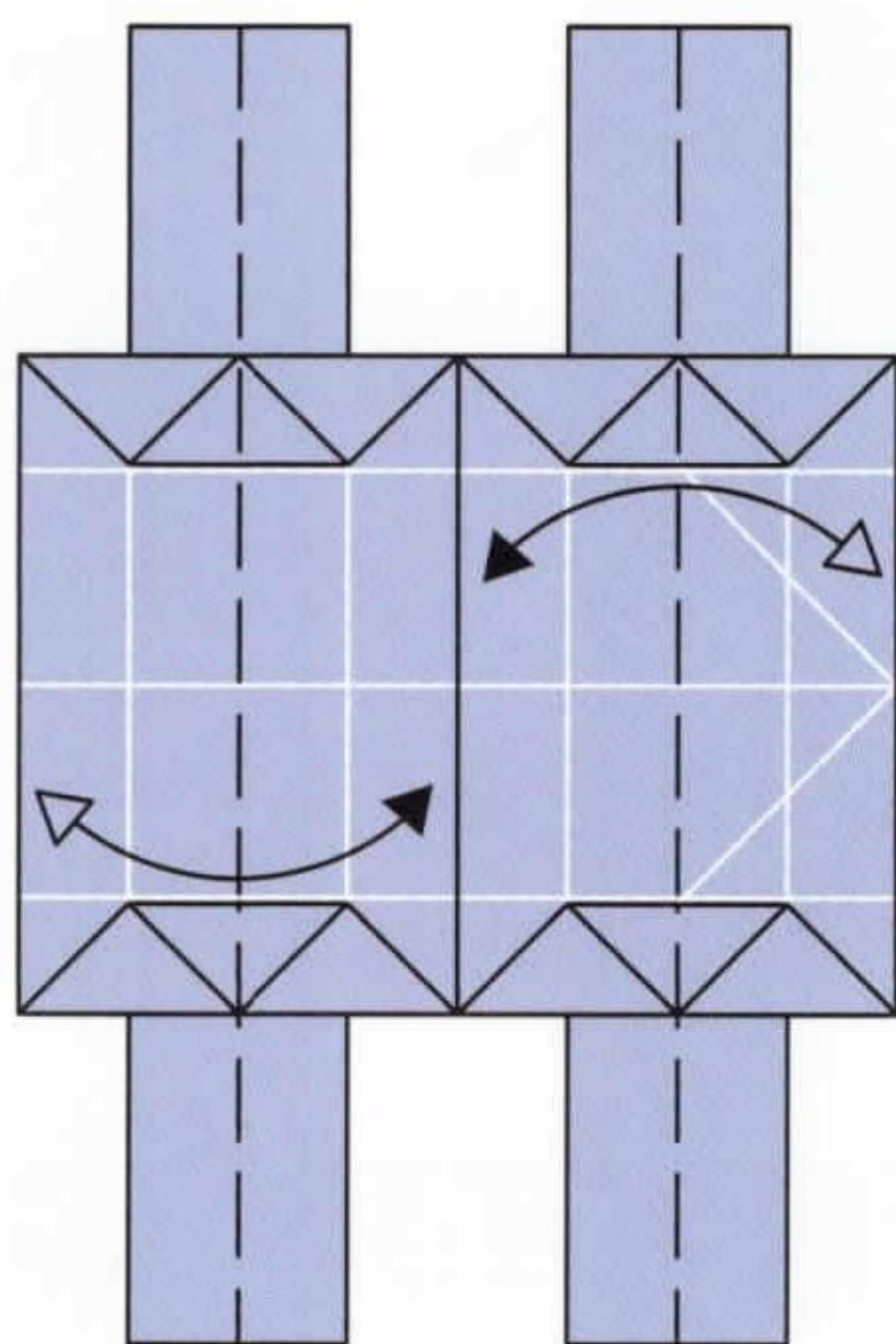

24. Repeat

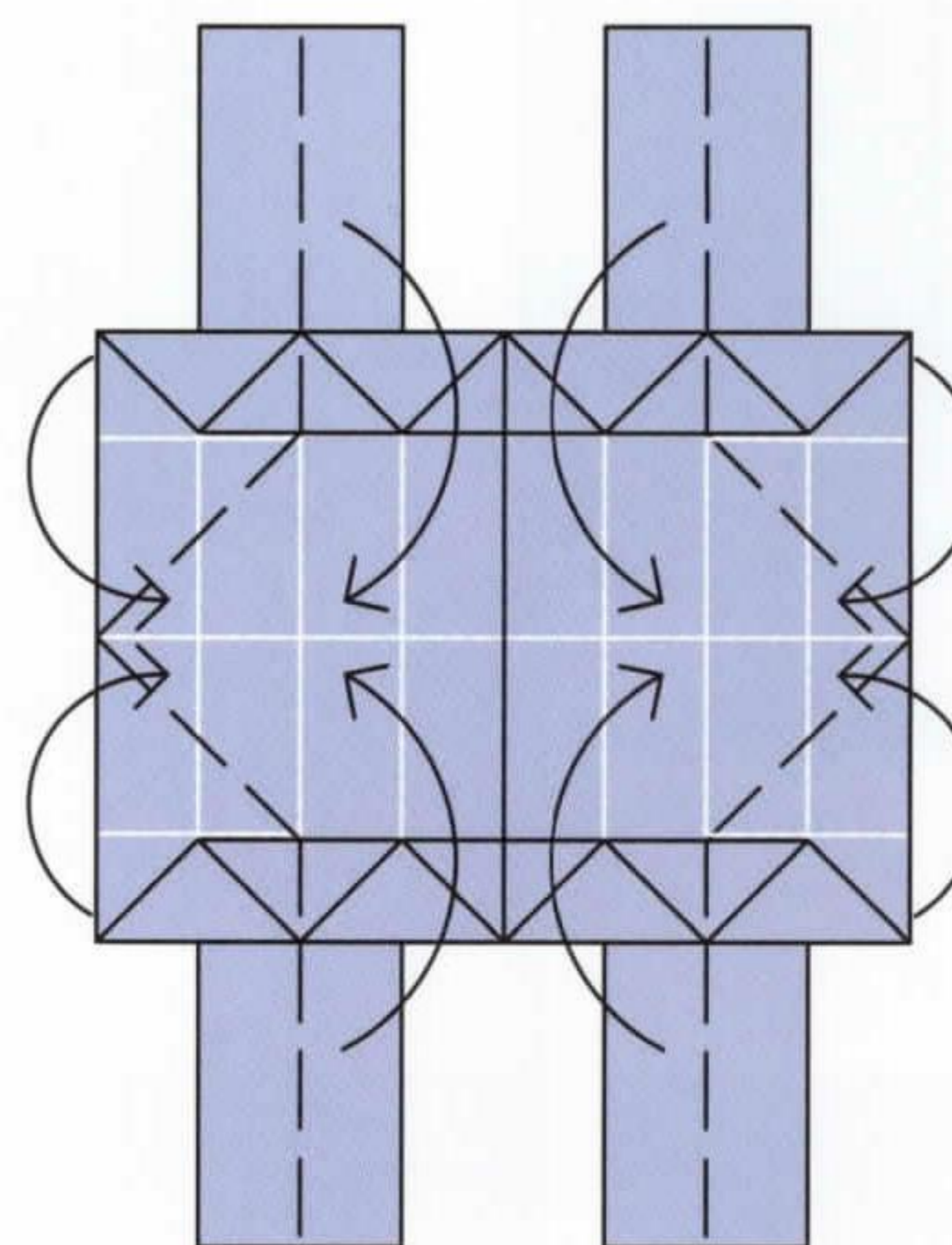

25. Valley folds inward

end table

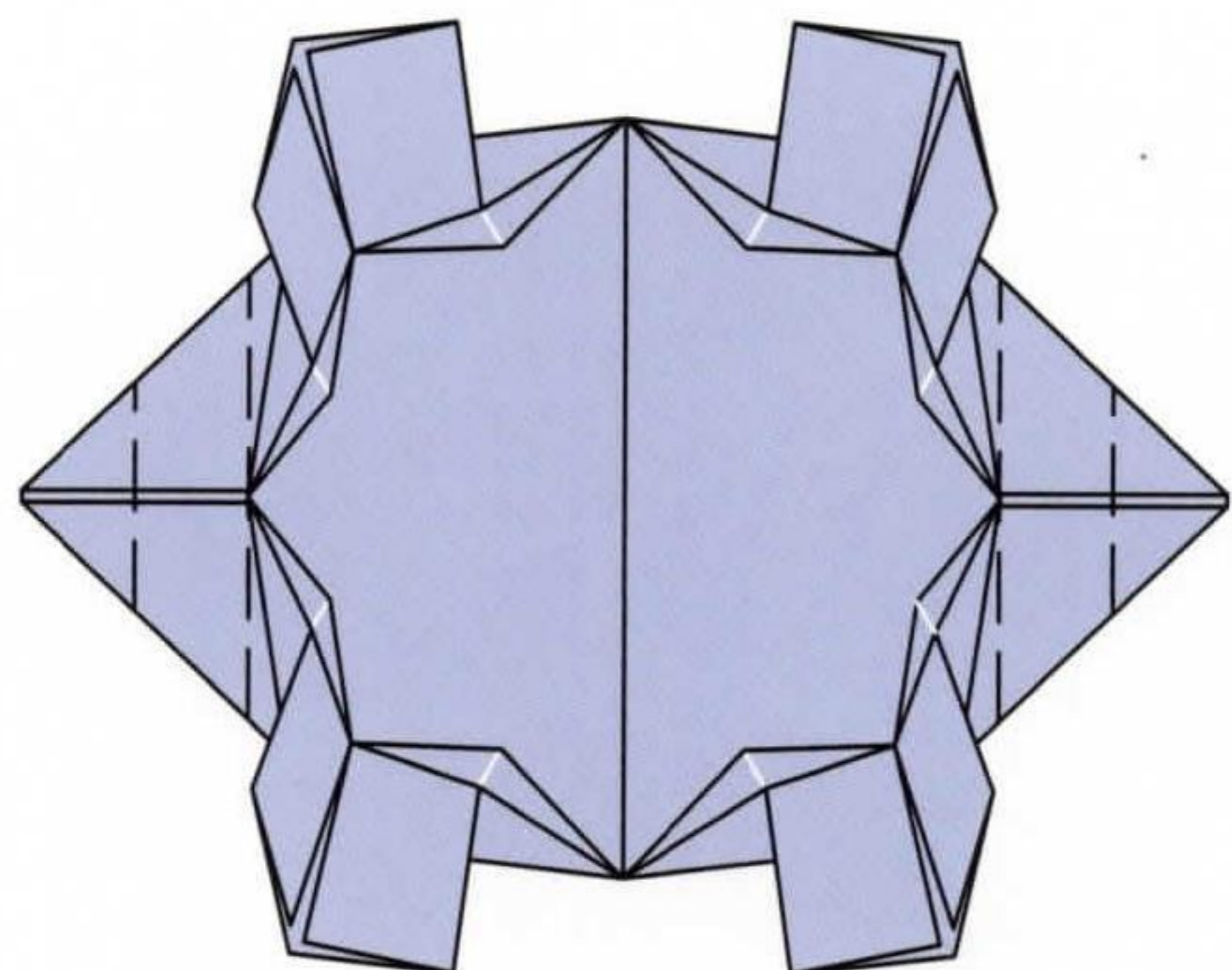

26. Valley fold twice

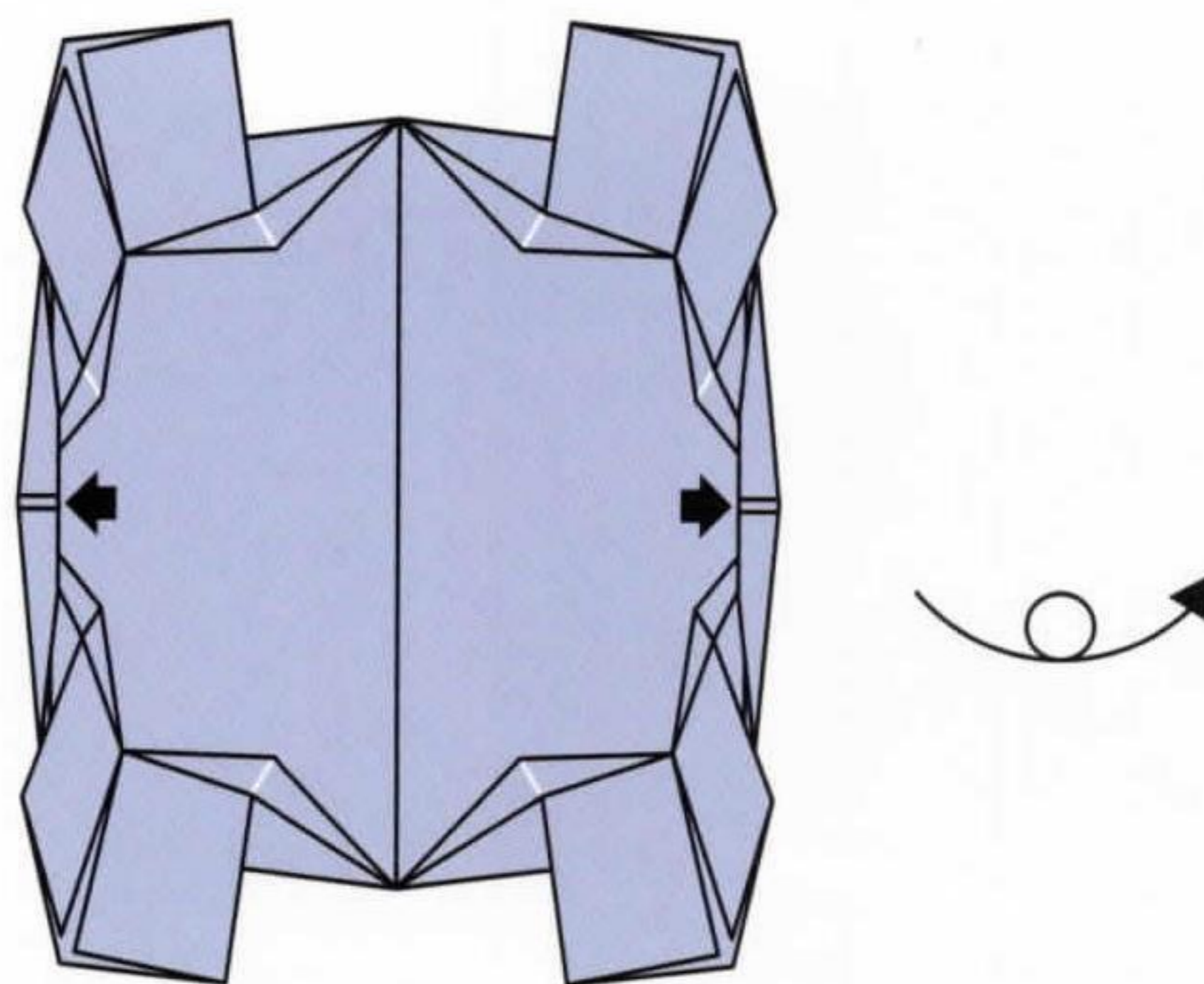

27. Add glue to both sides and turn over

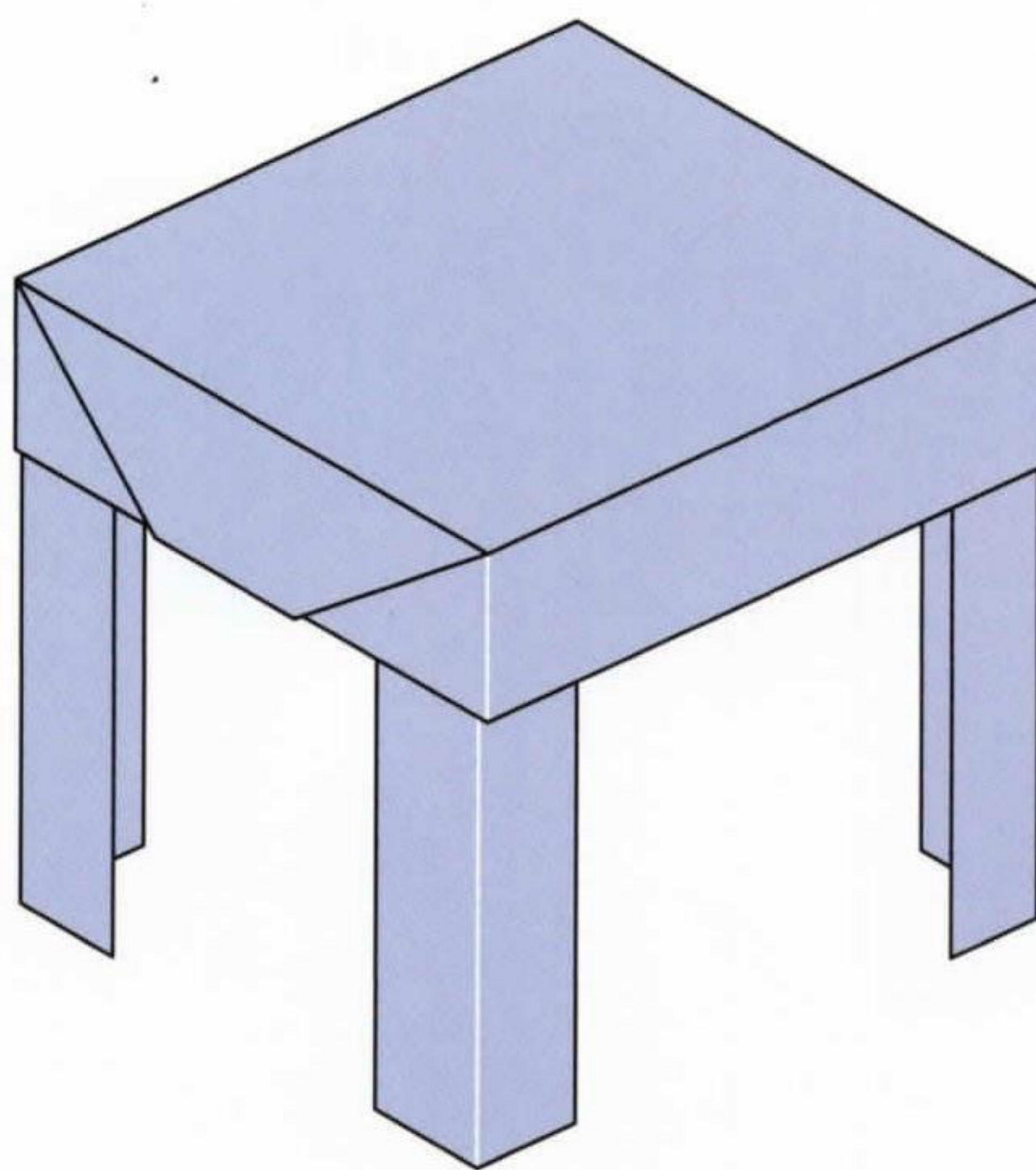

28. Completed
END TABLE



2

dining room

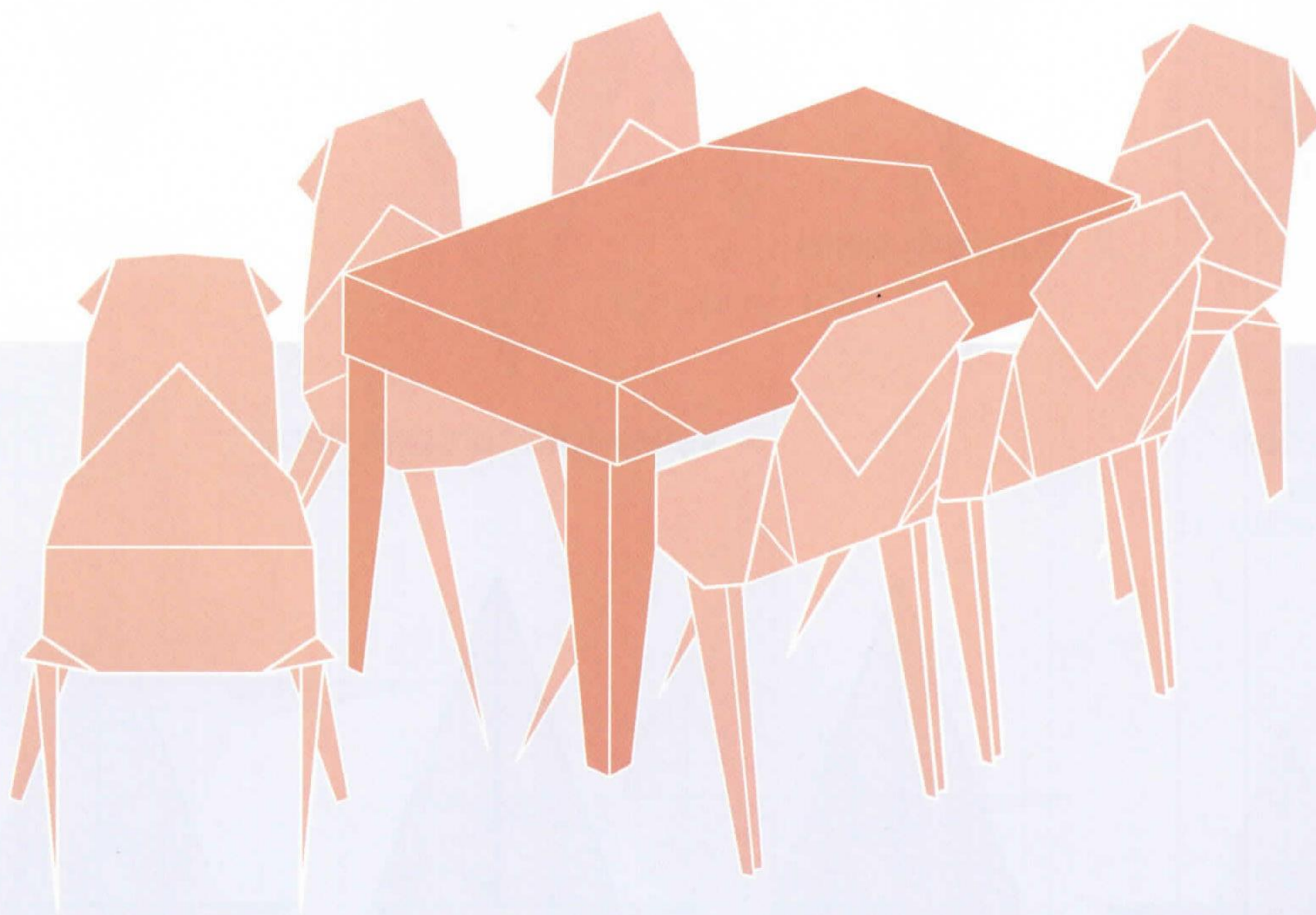

dinette chair | dinette table

➤ dinette chair

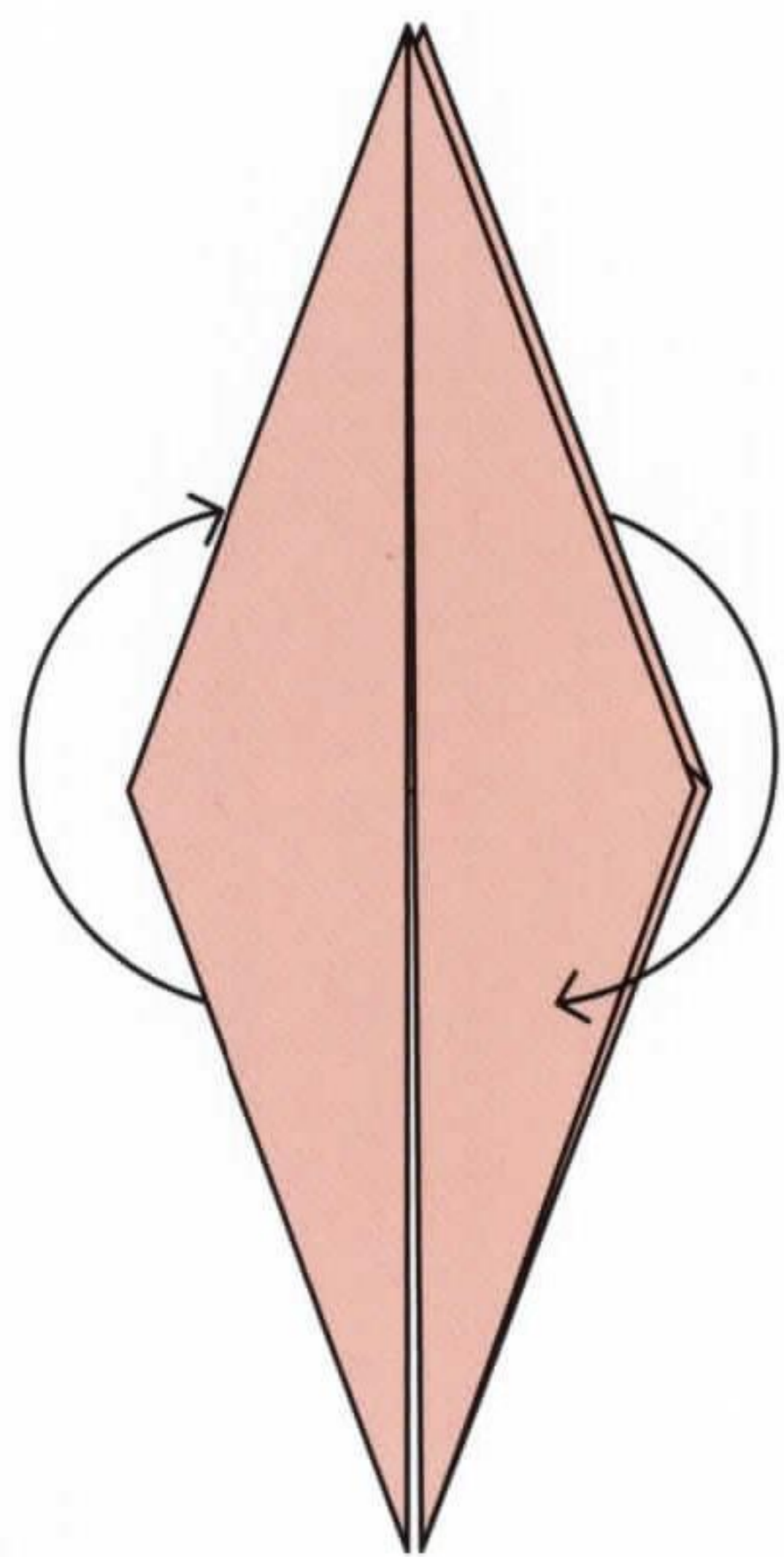

1. Bird base, then open flaps

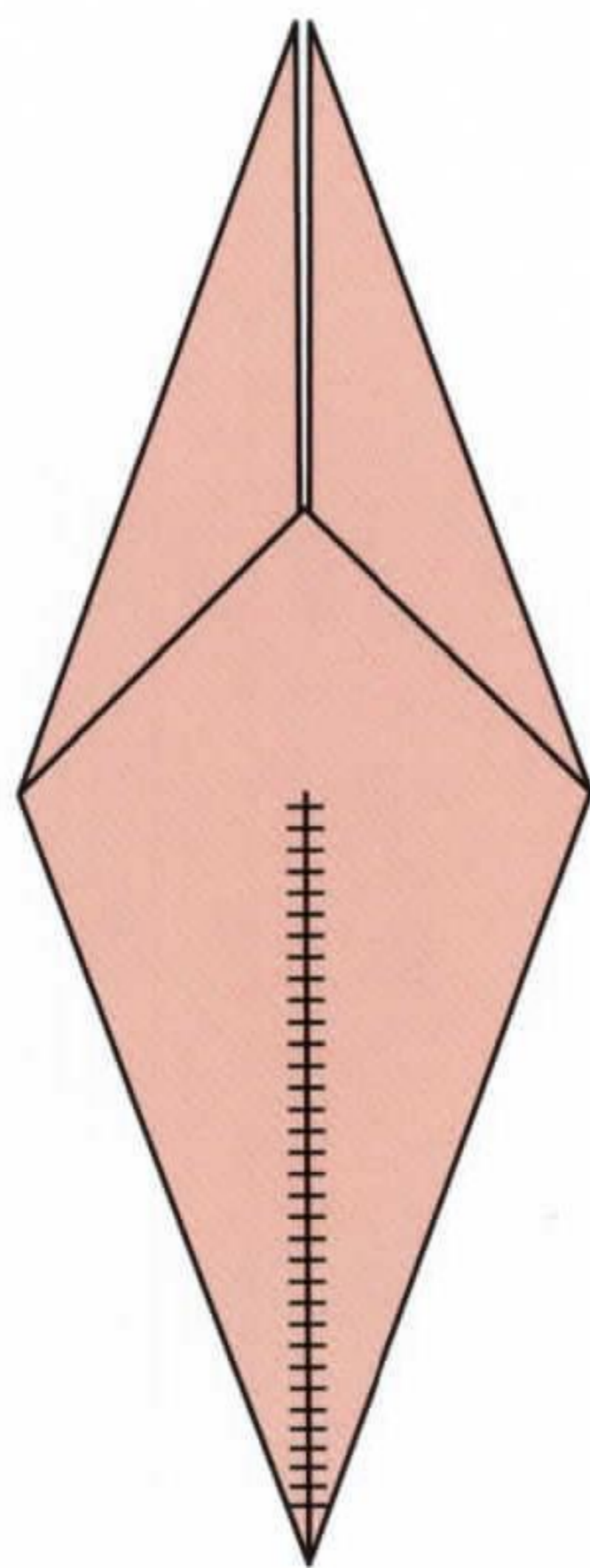

2. Cut both sides

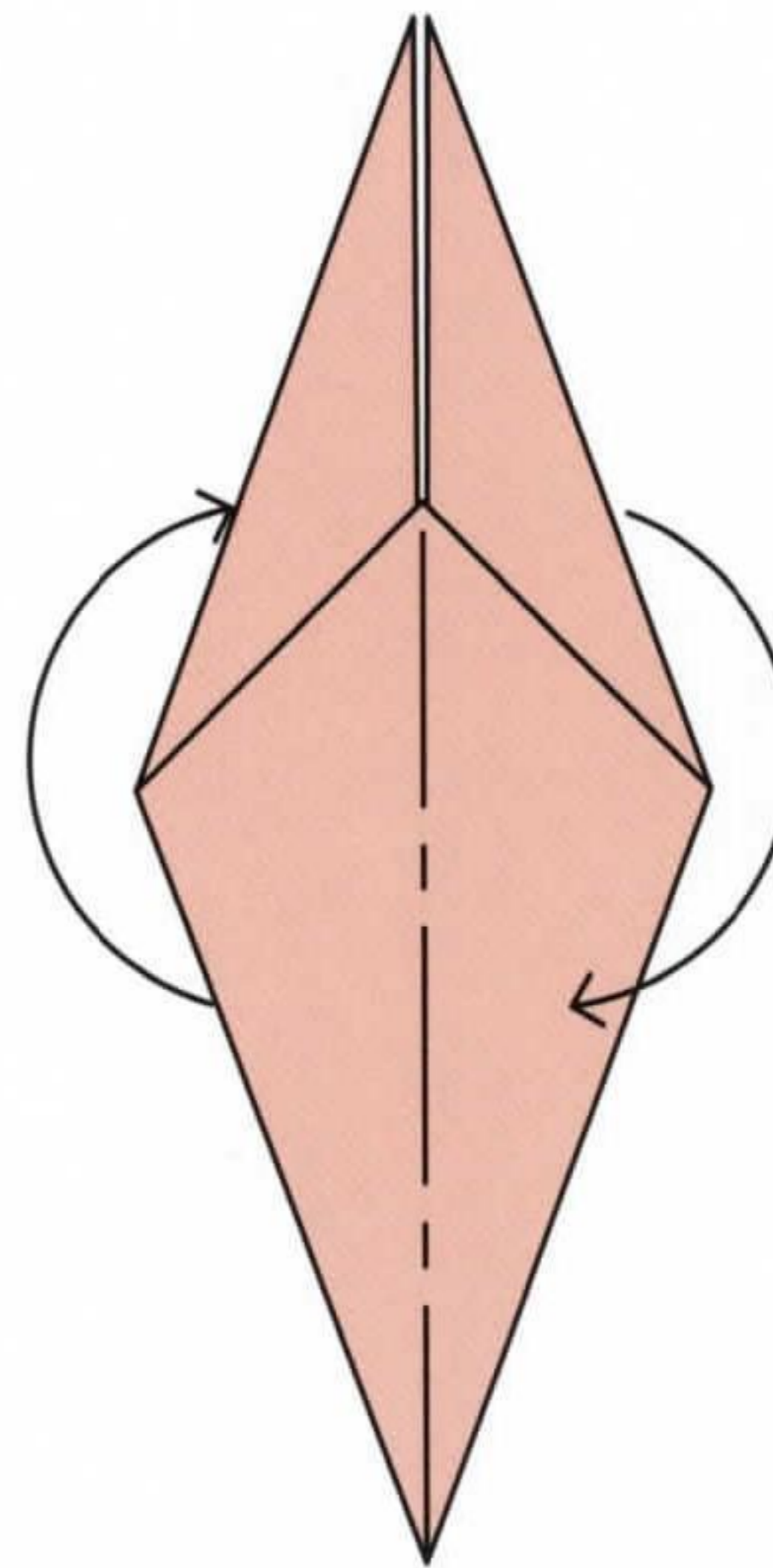

3. Valley fold to open flaps

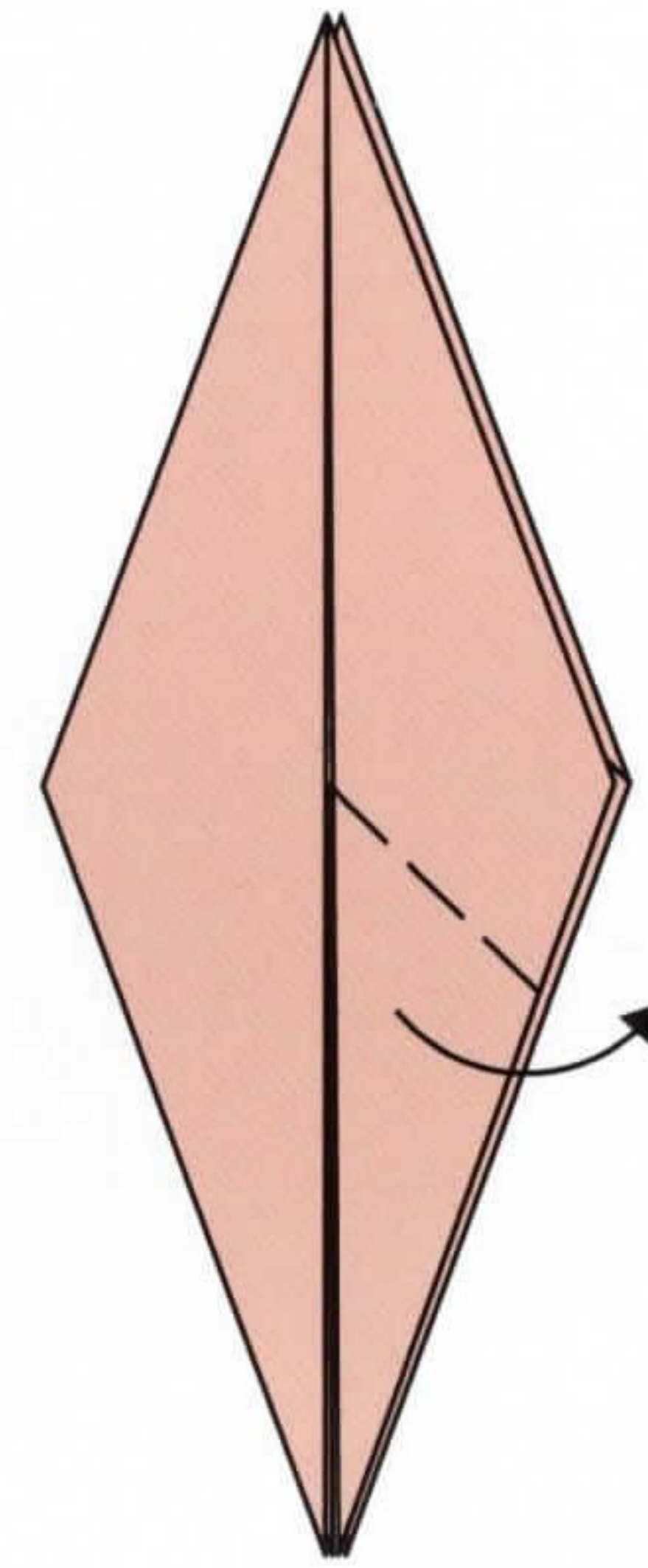

4. Valley fold

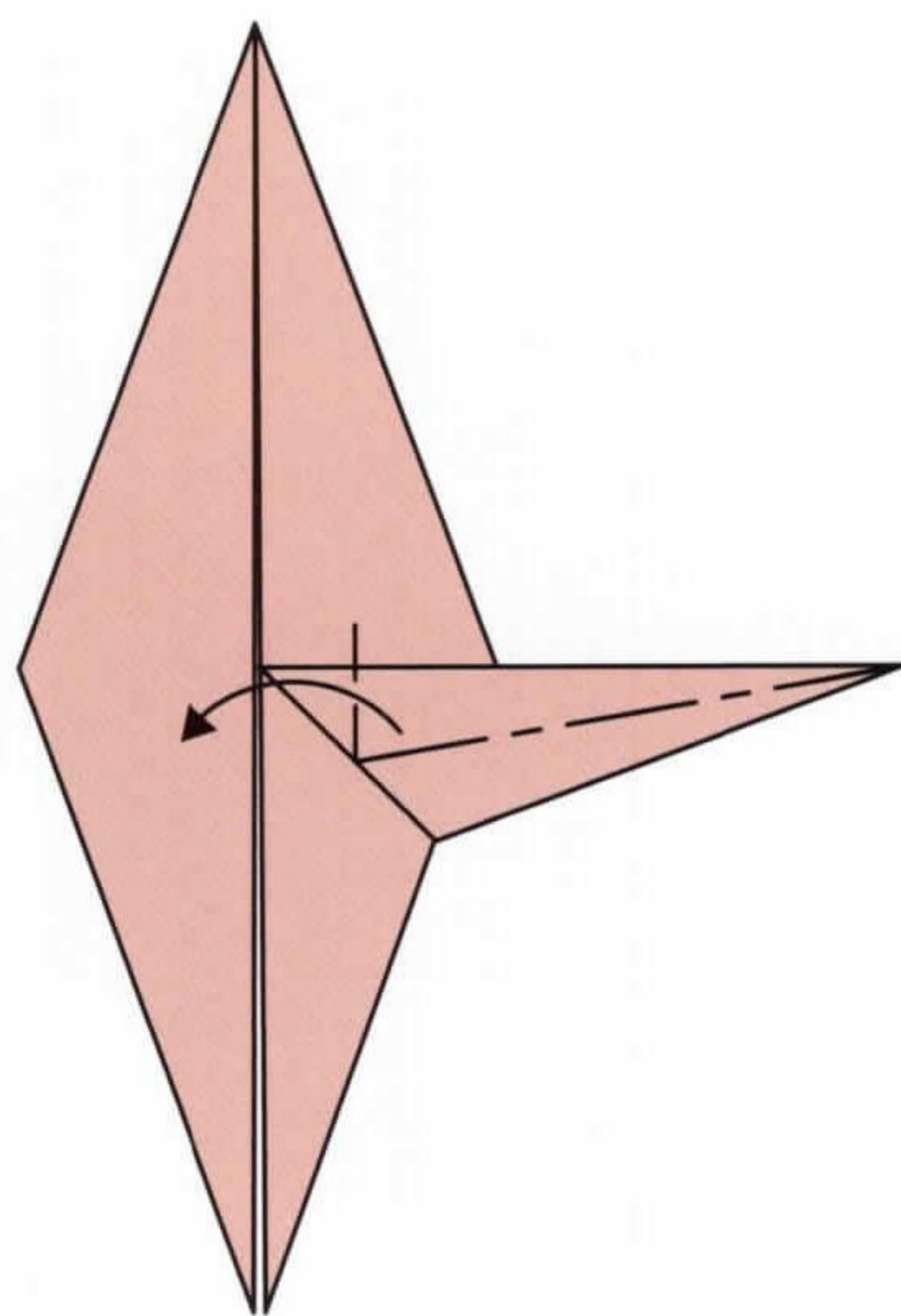

5. Crimp fold

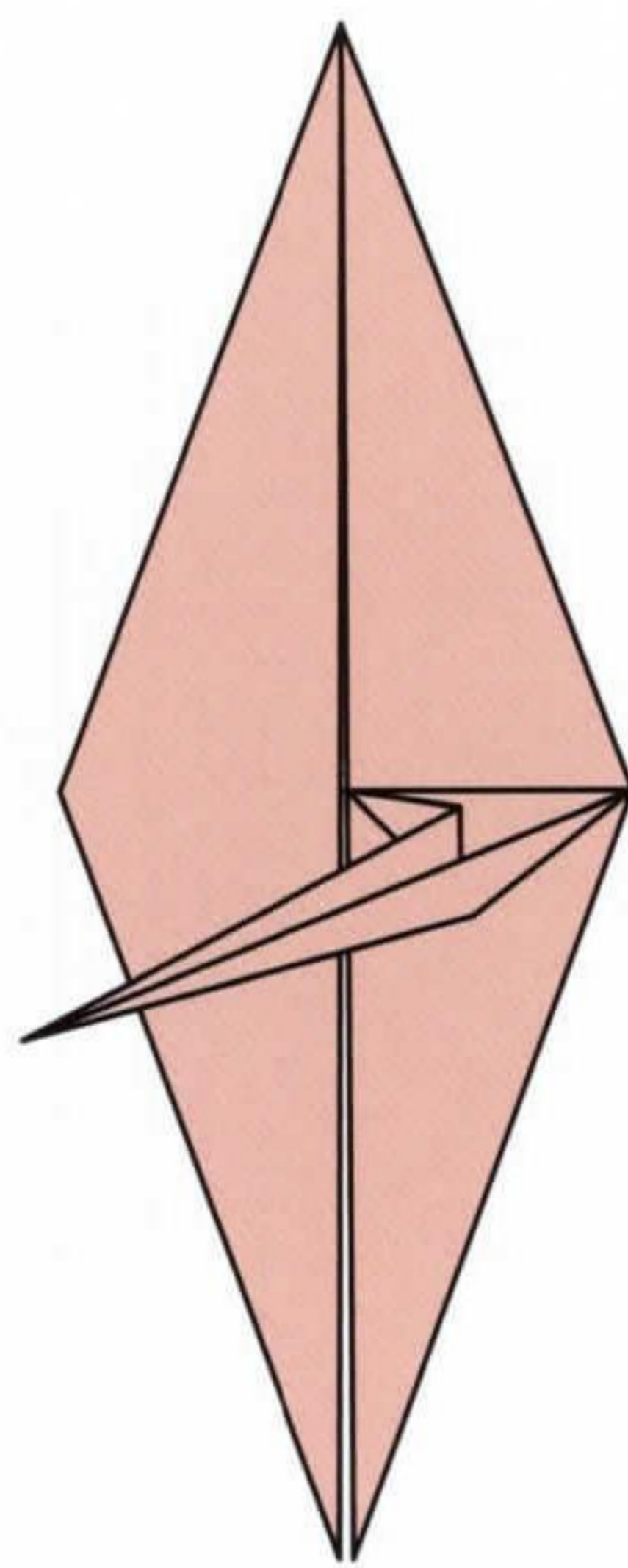

6. Before complete

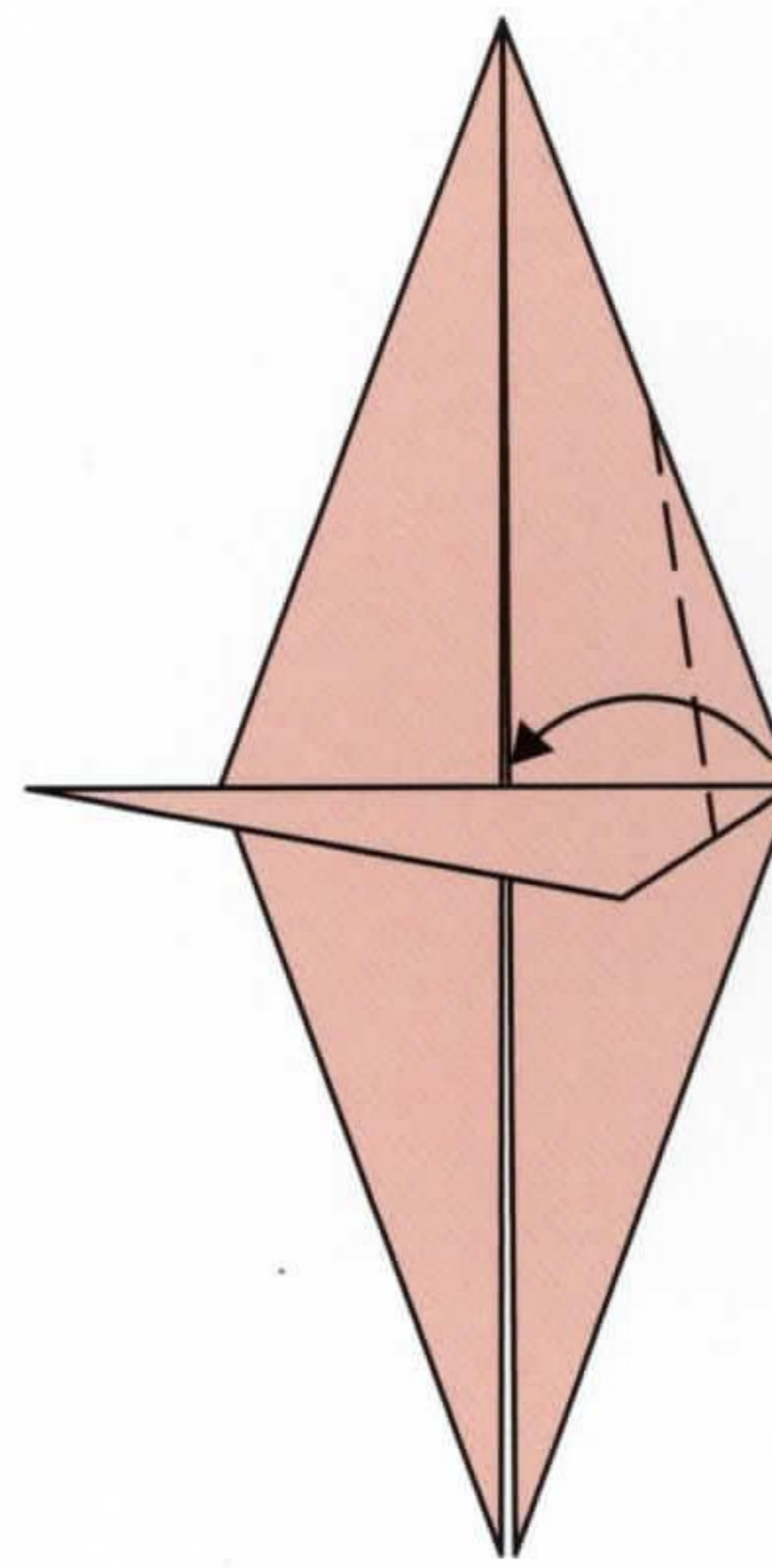

7. Valley fold

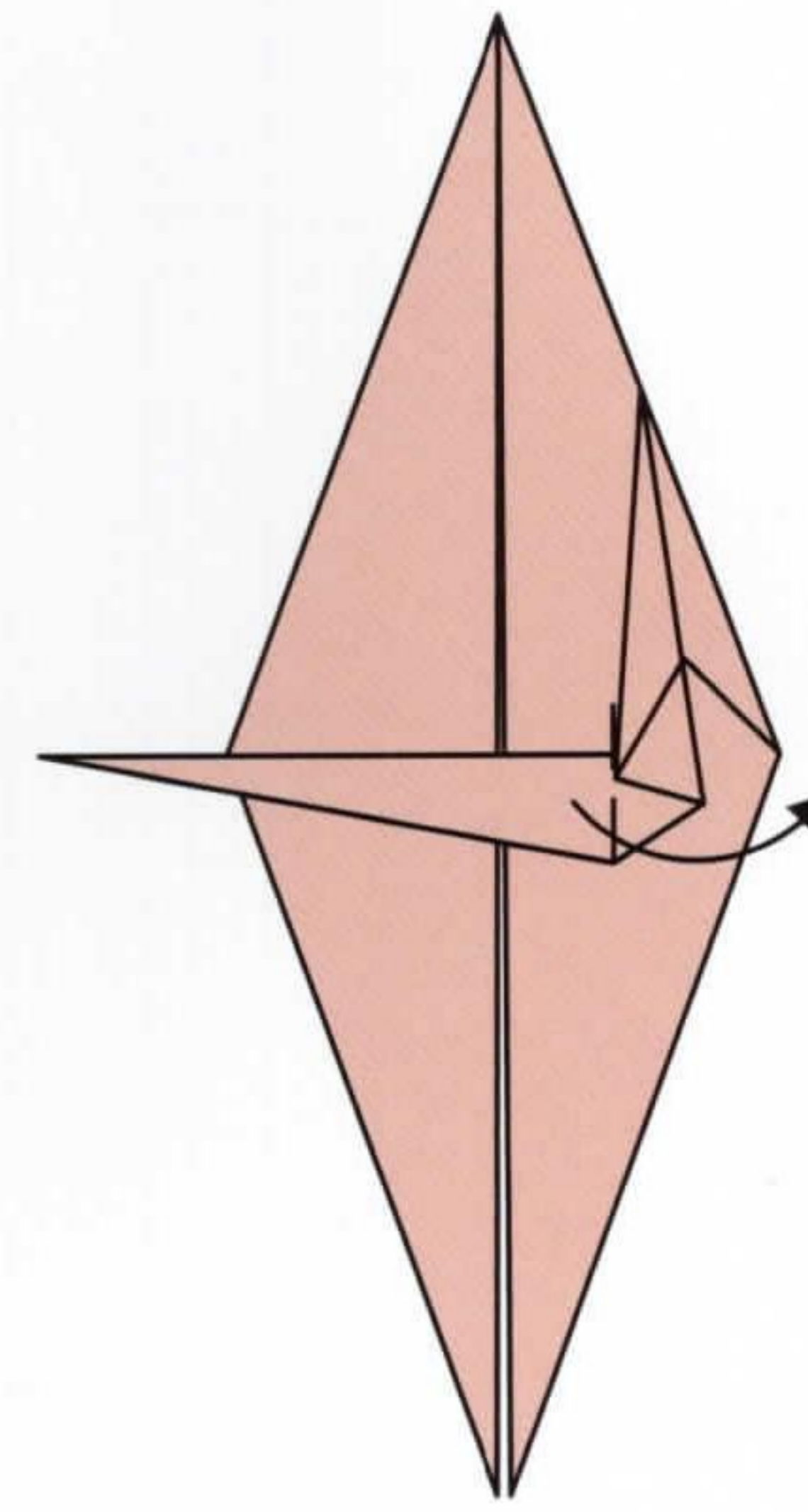

8. Valley fold

dinette chair

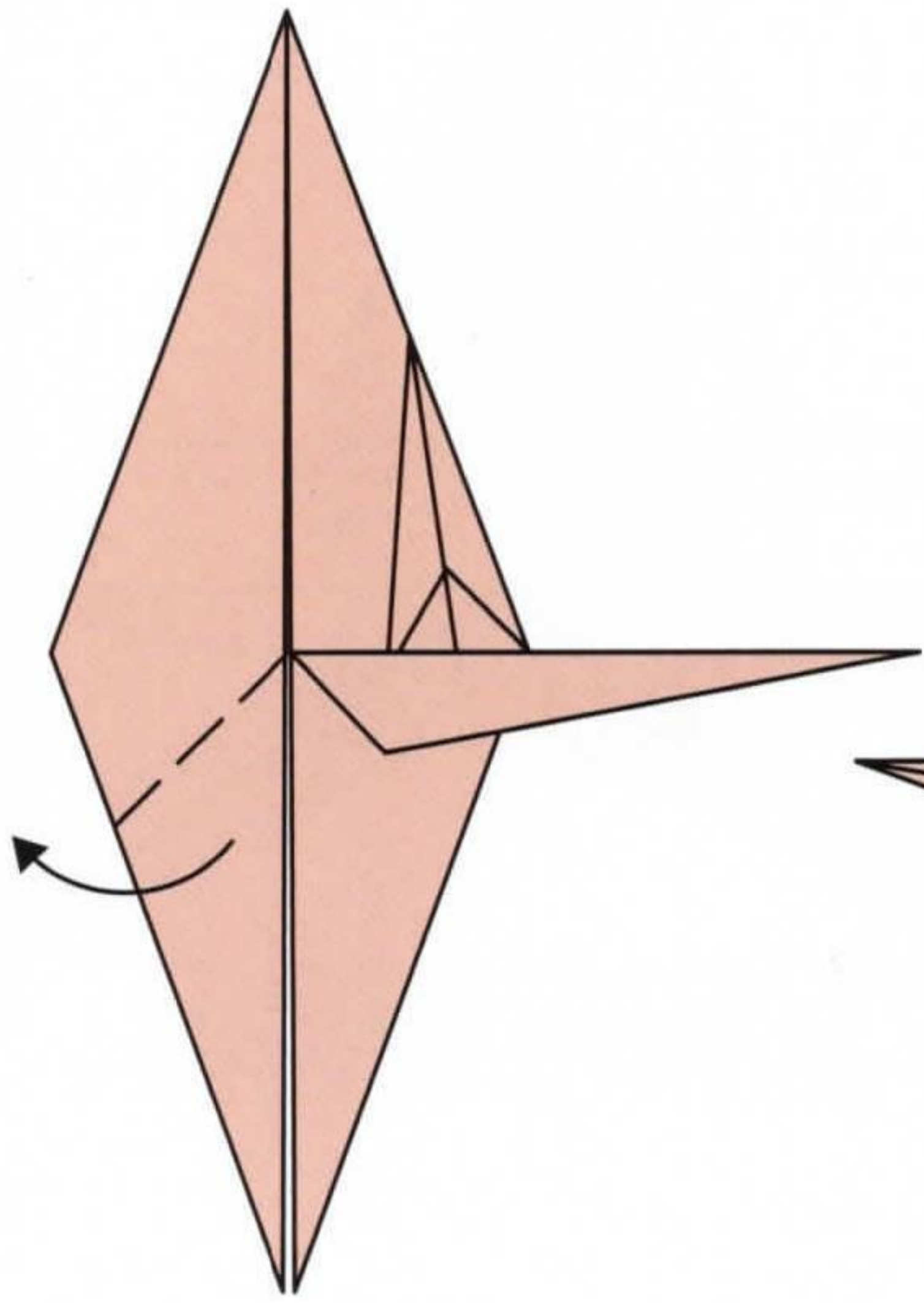

9. Valley fold

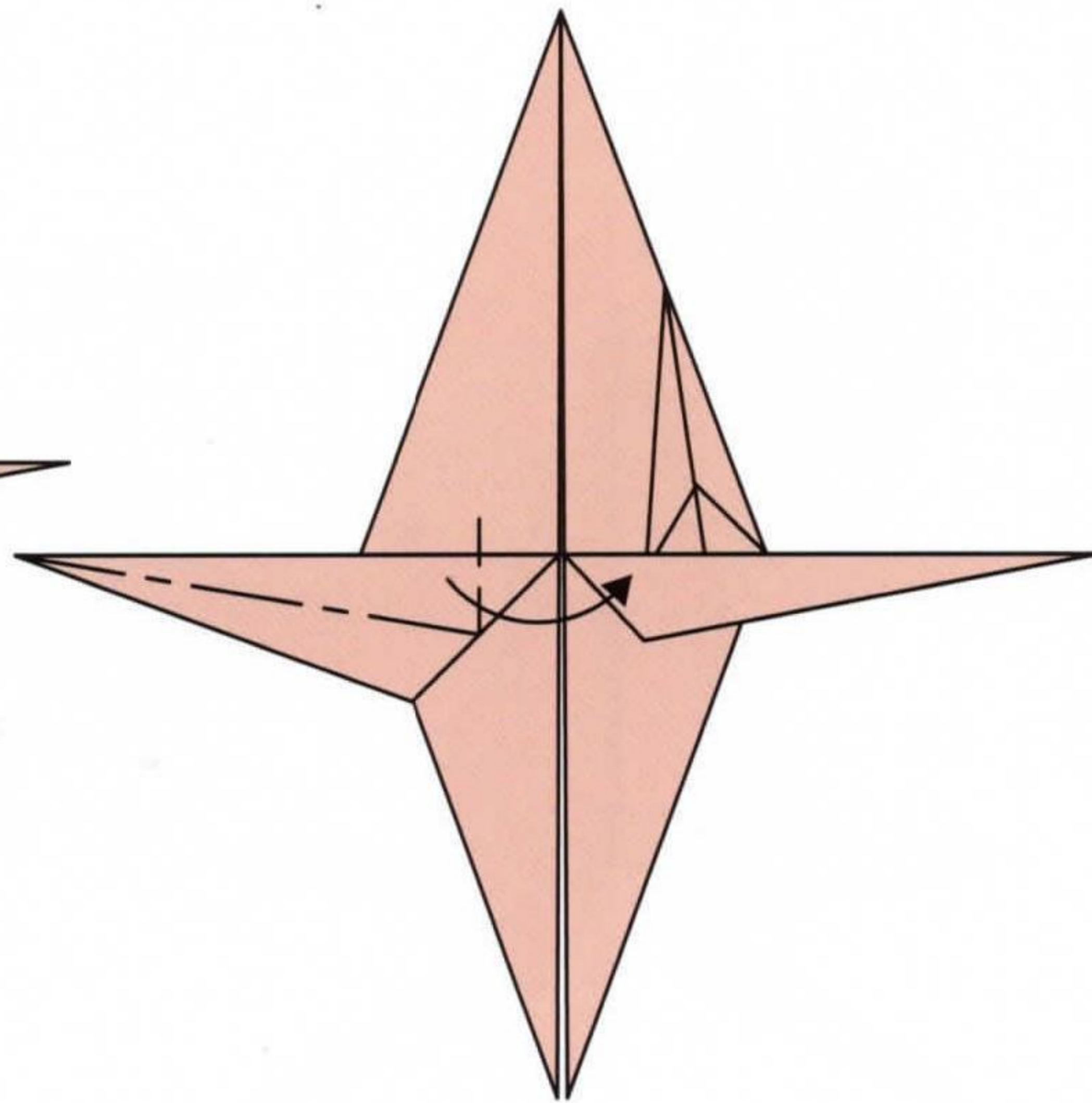

10. Crimp fold

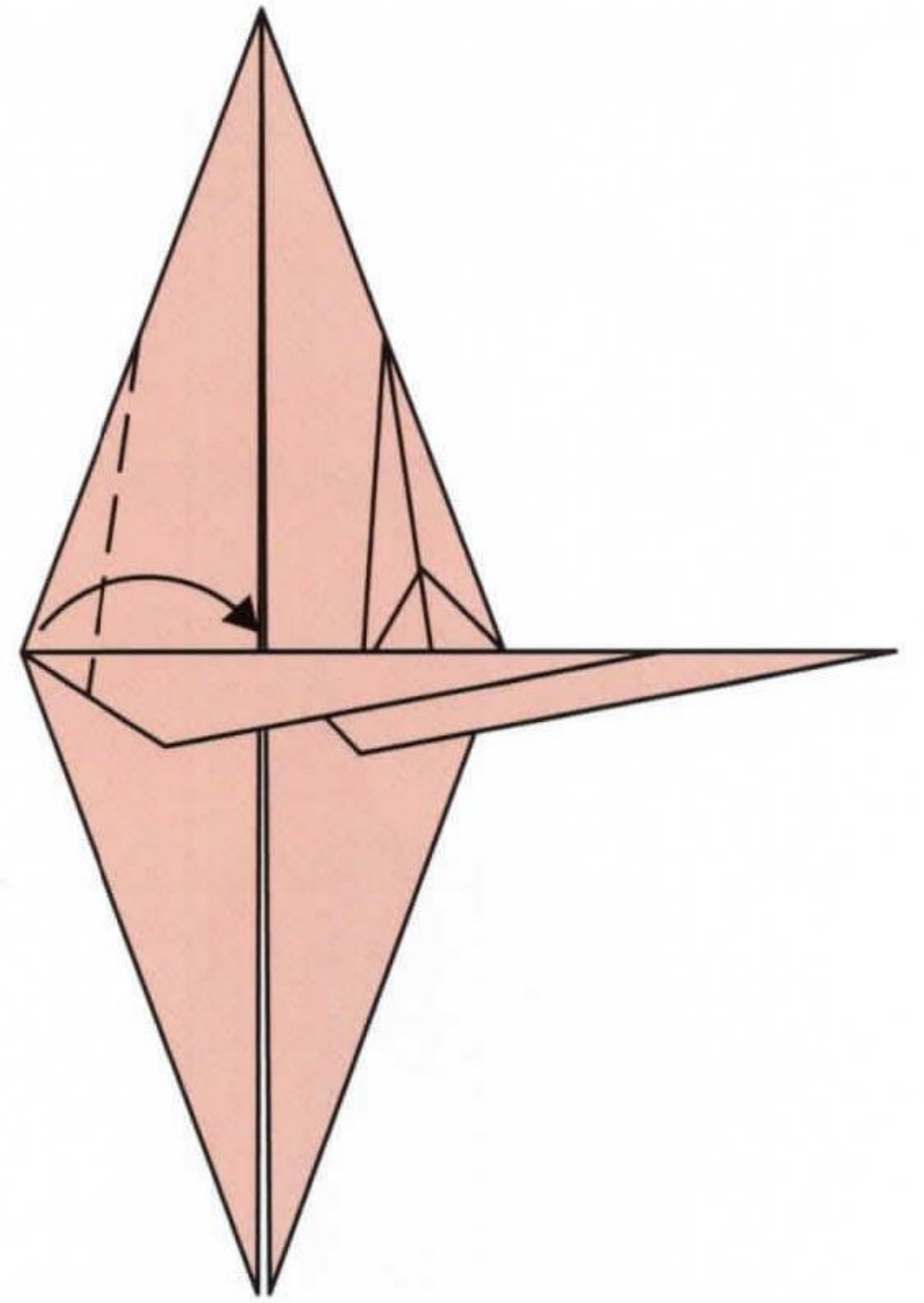

11. Valley fold

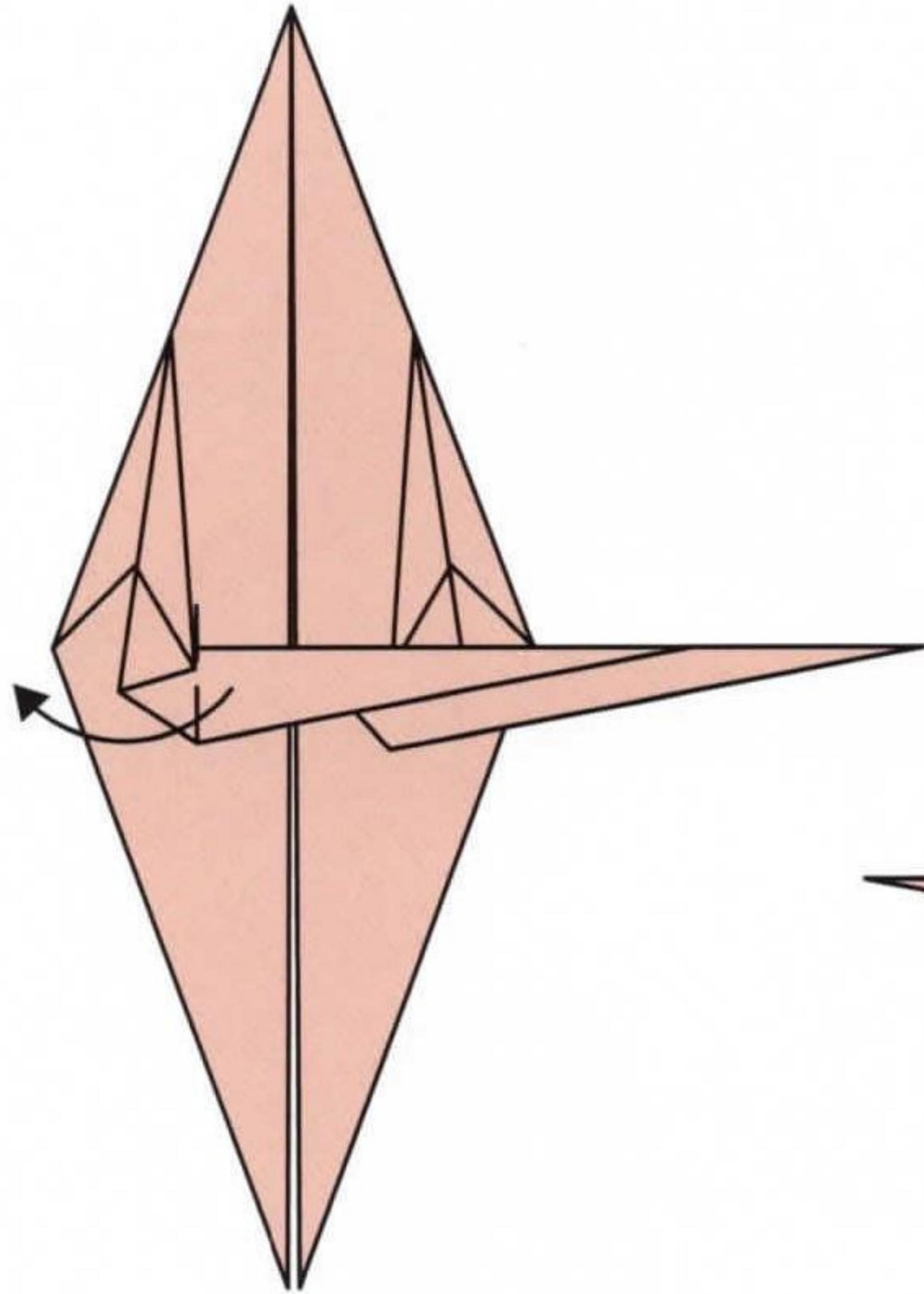

12. Valley fold

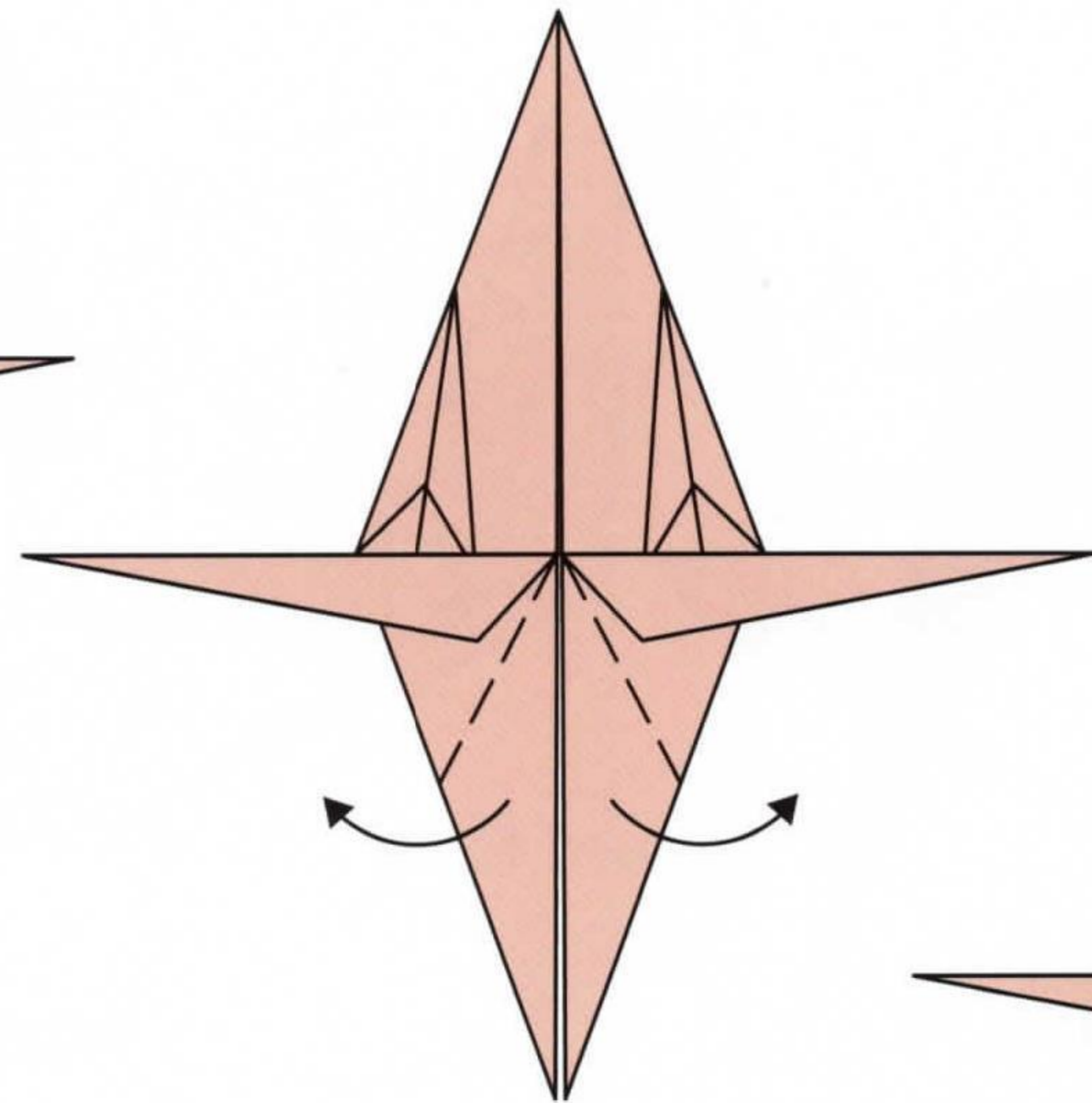

13. Valley folds

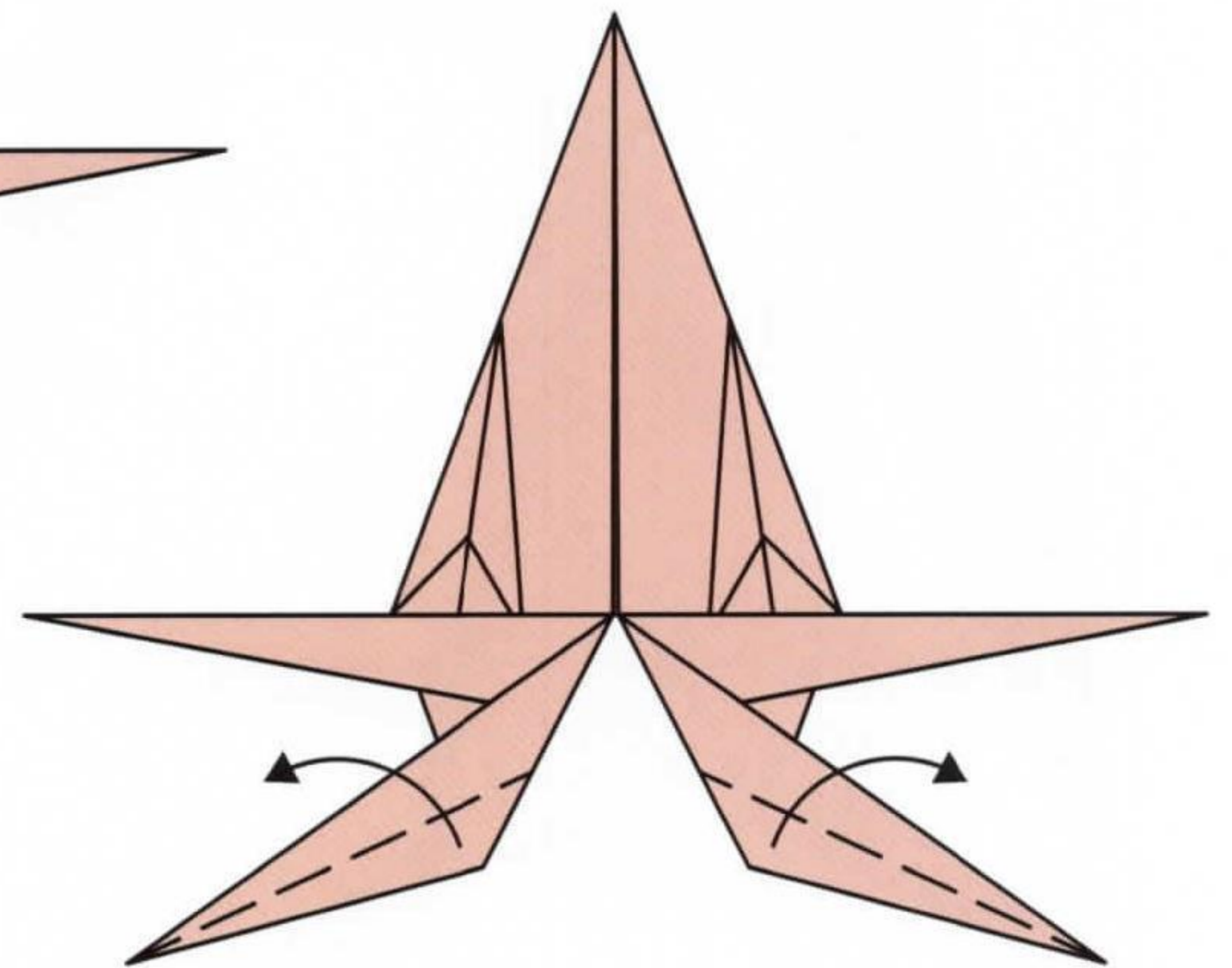

14. Valley folds

dinette chair

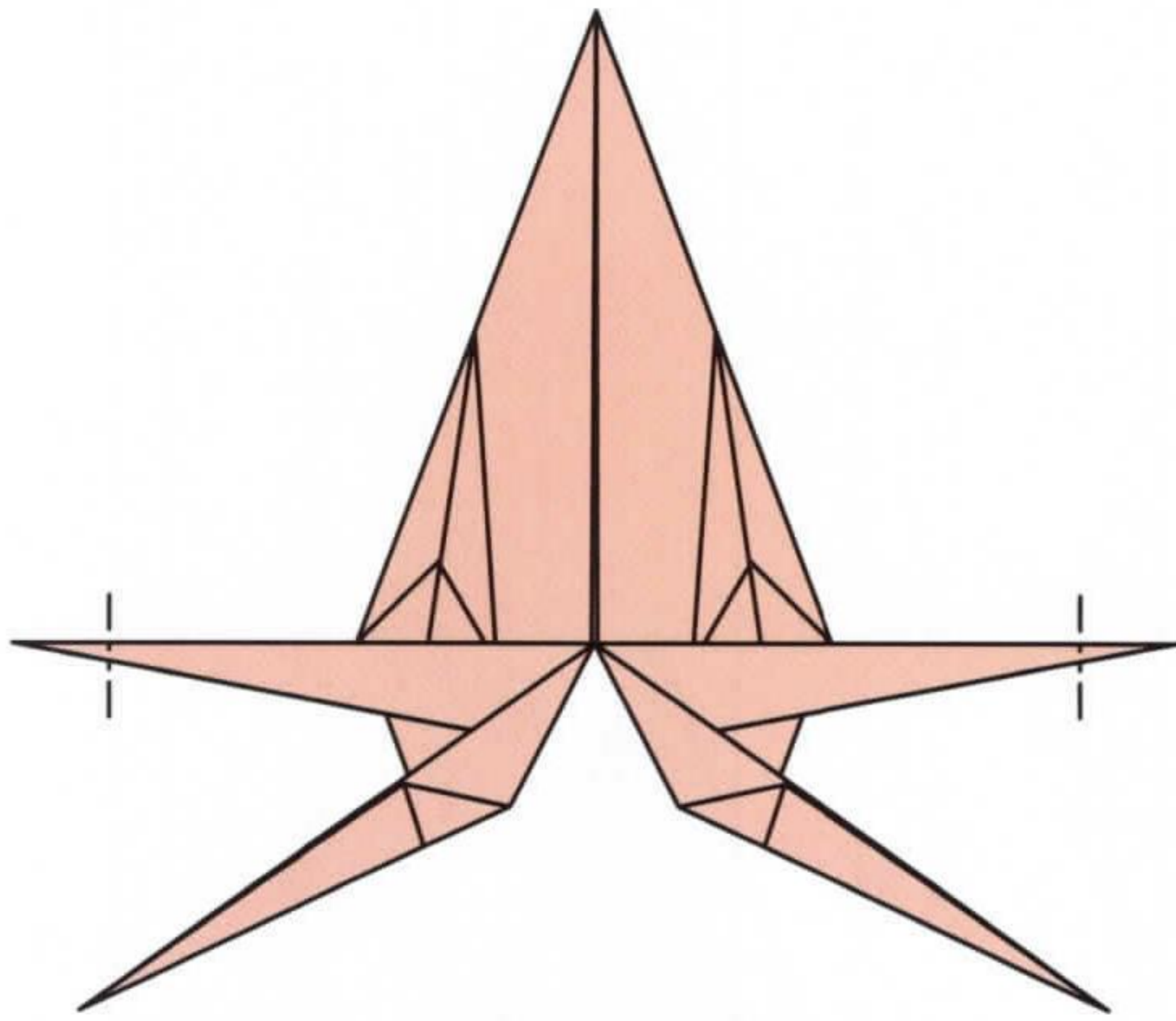

15. Inside reverse folds

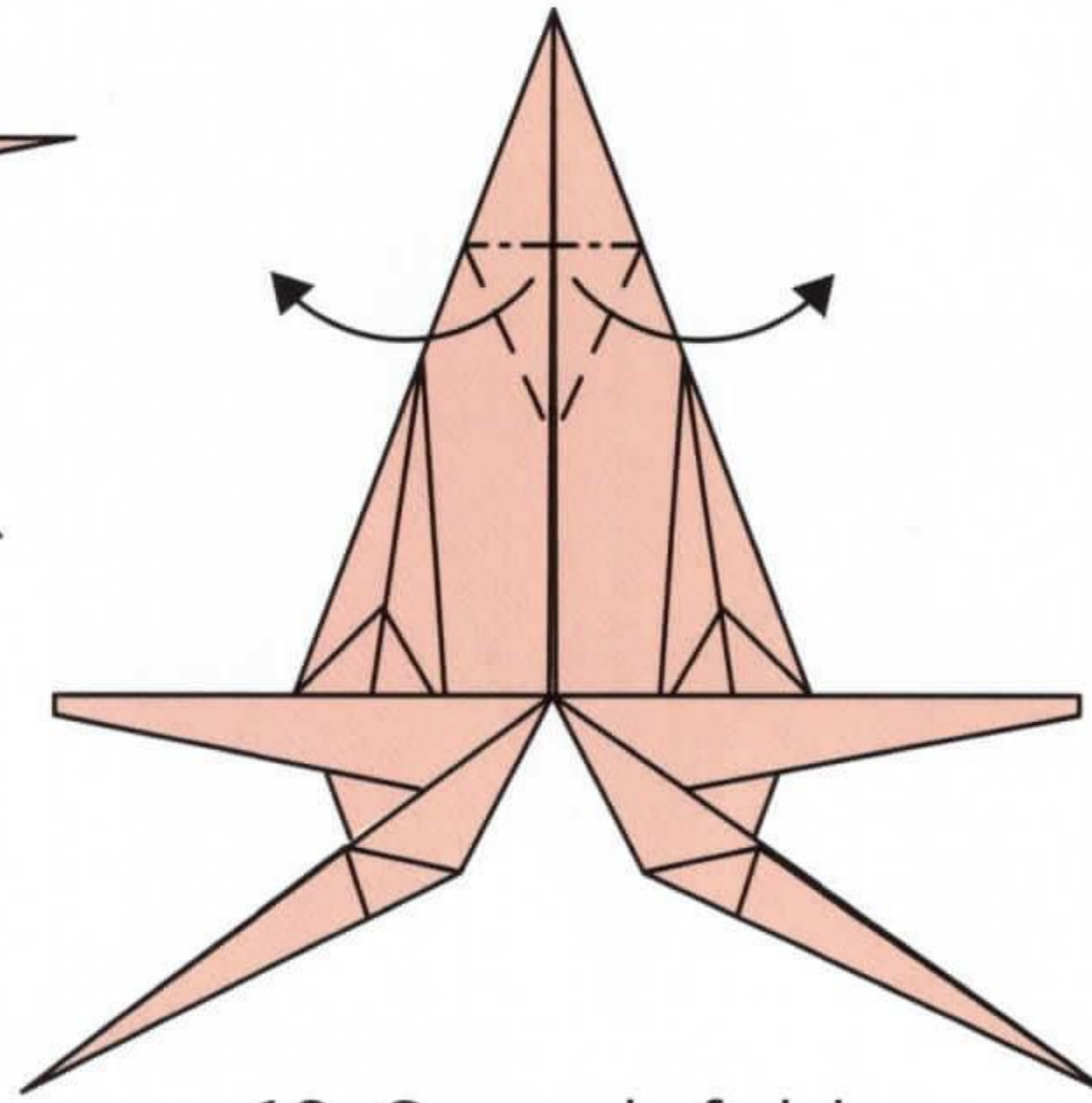

16. Squash fold

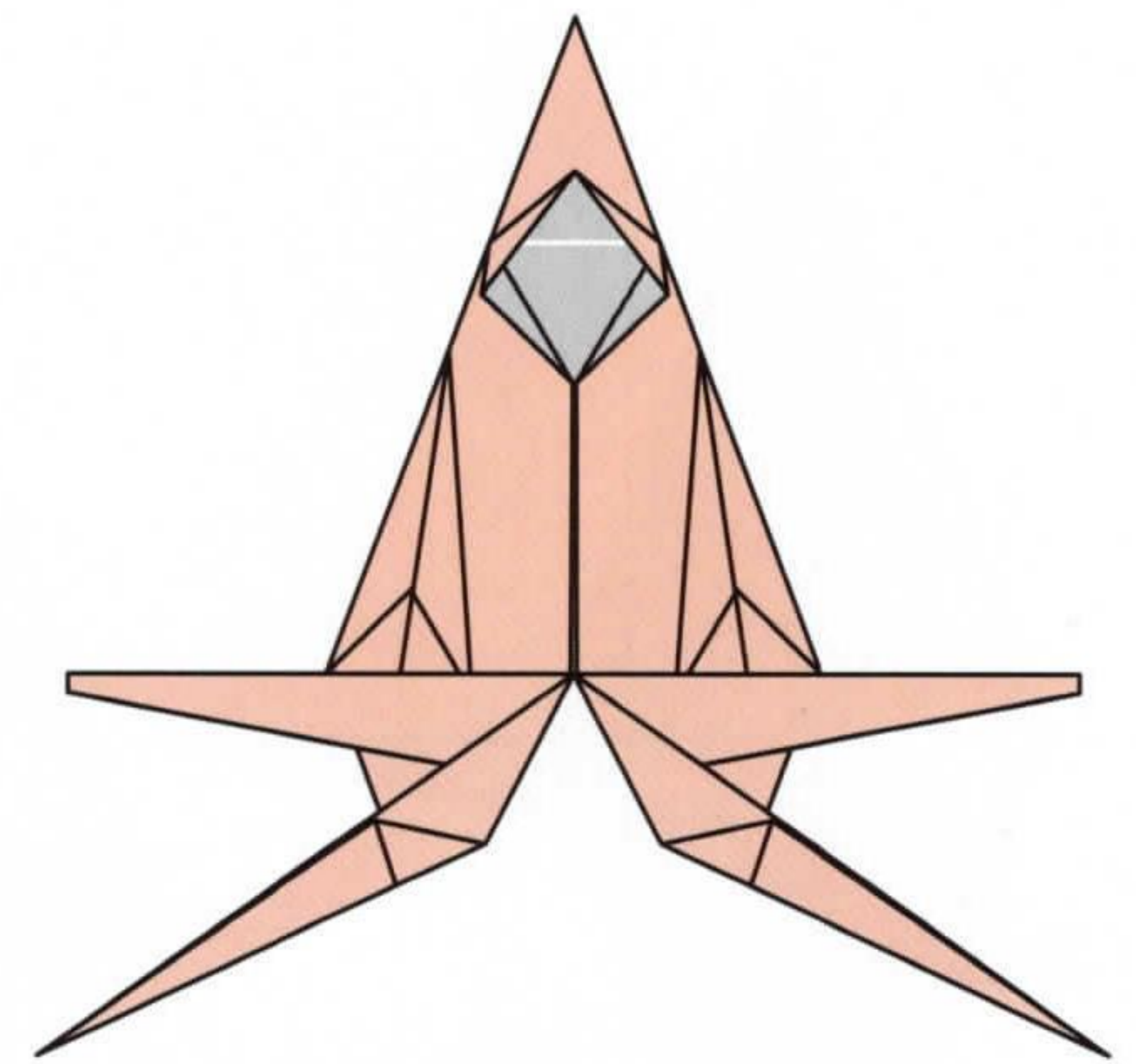

17. Before complete

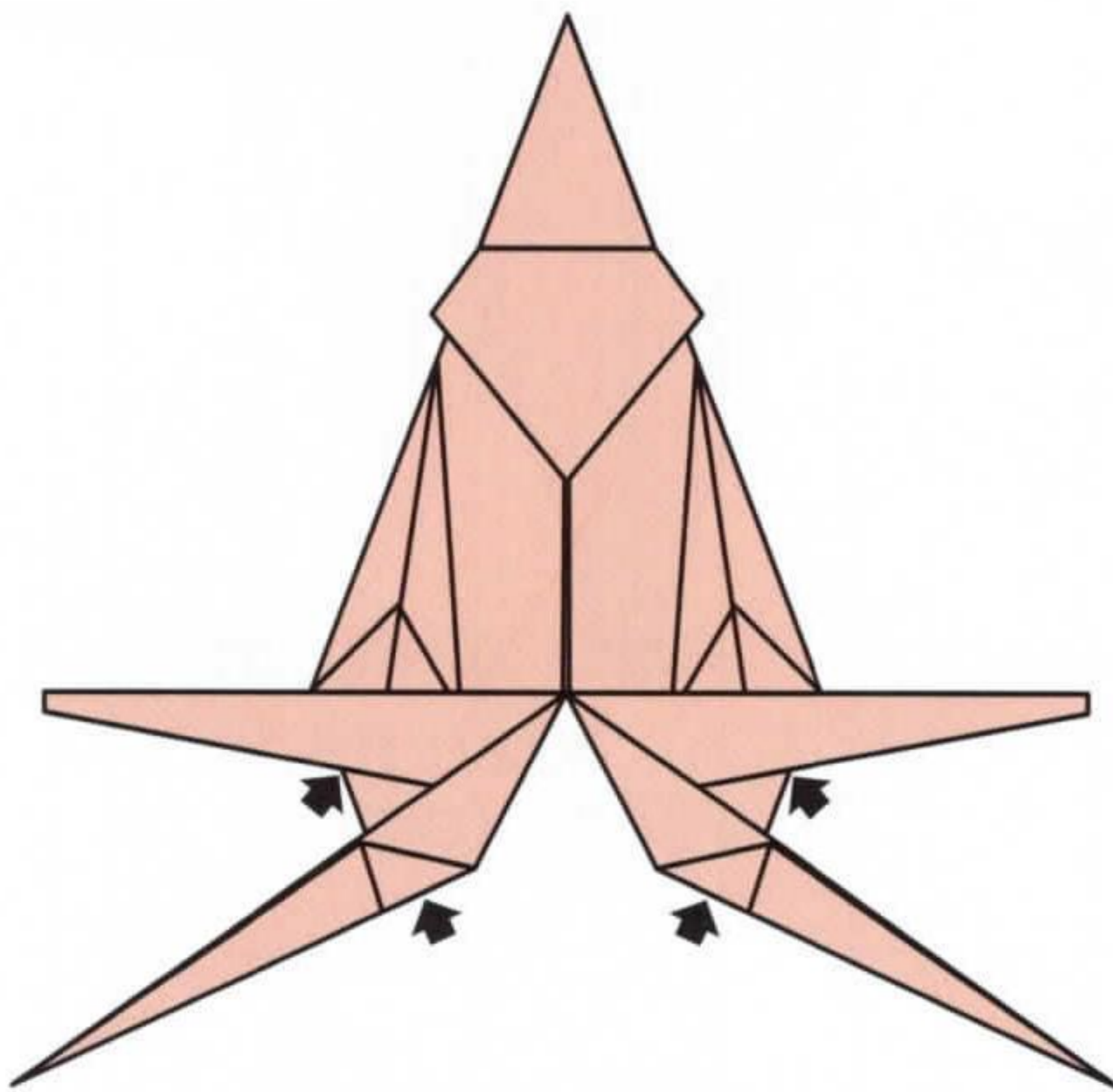

18. Add glue and turn over

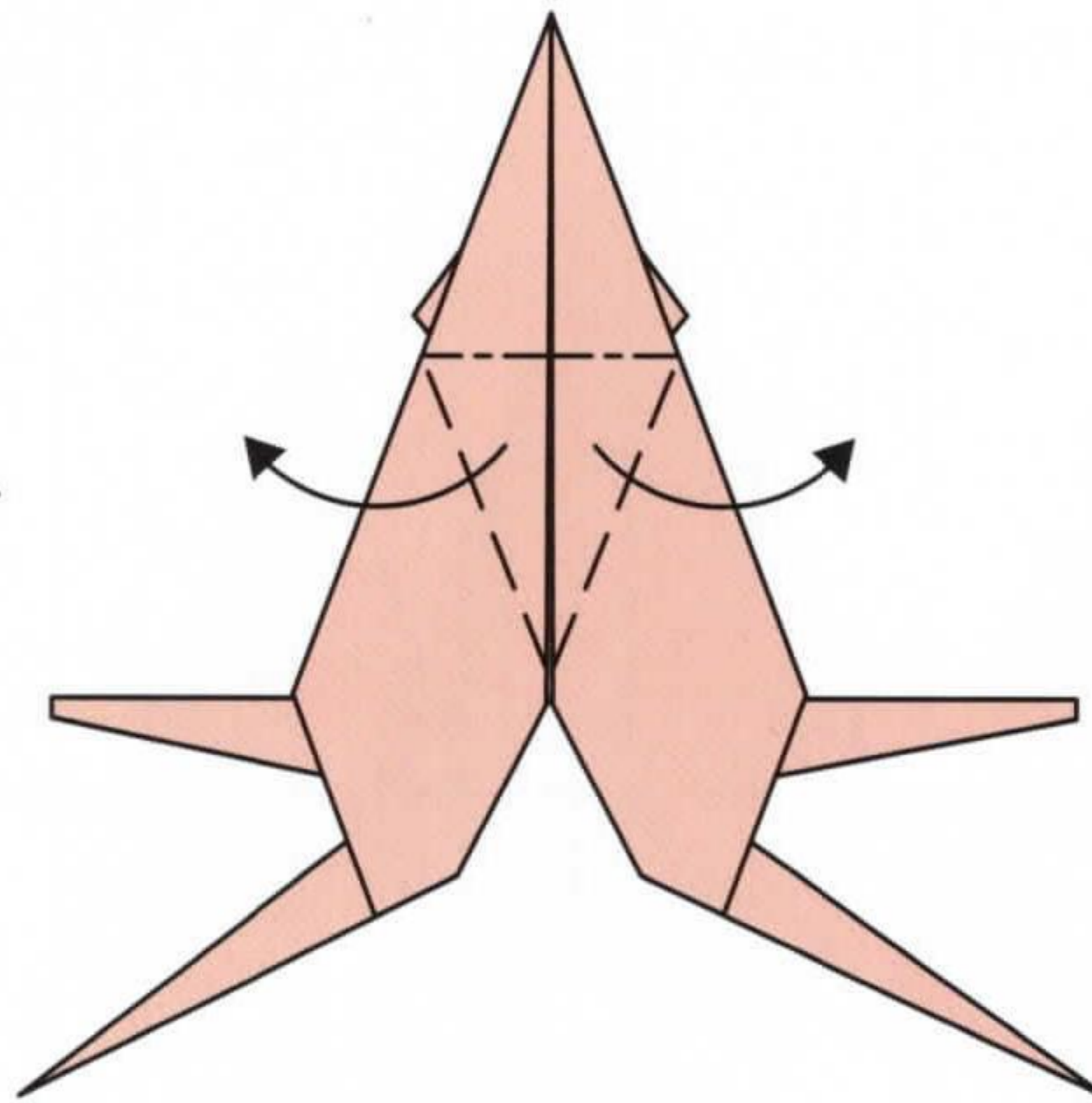

19. Squash folds

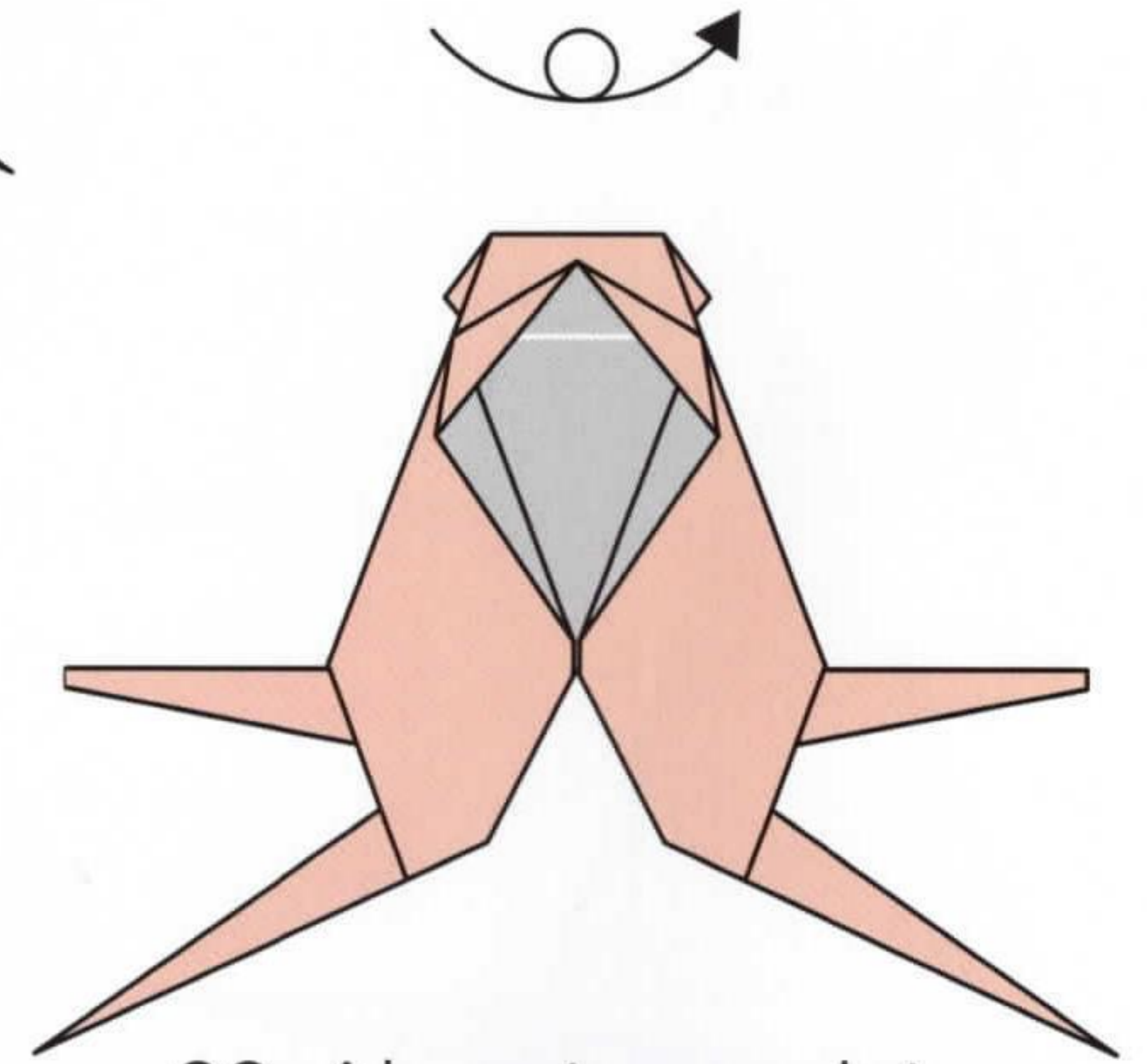

20. Almost complete

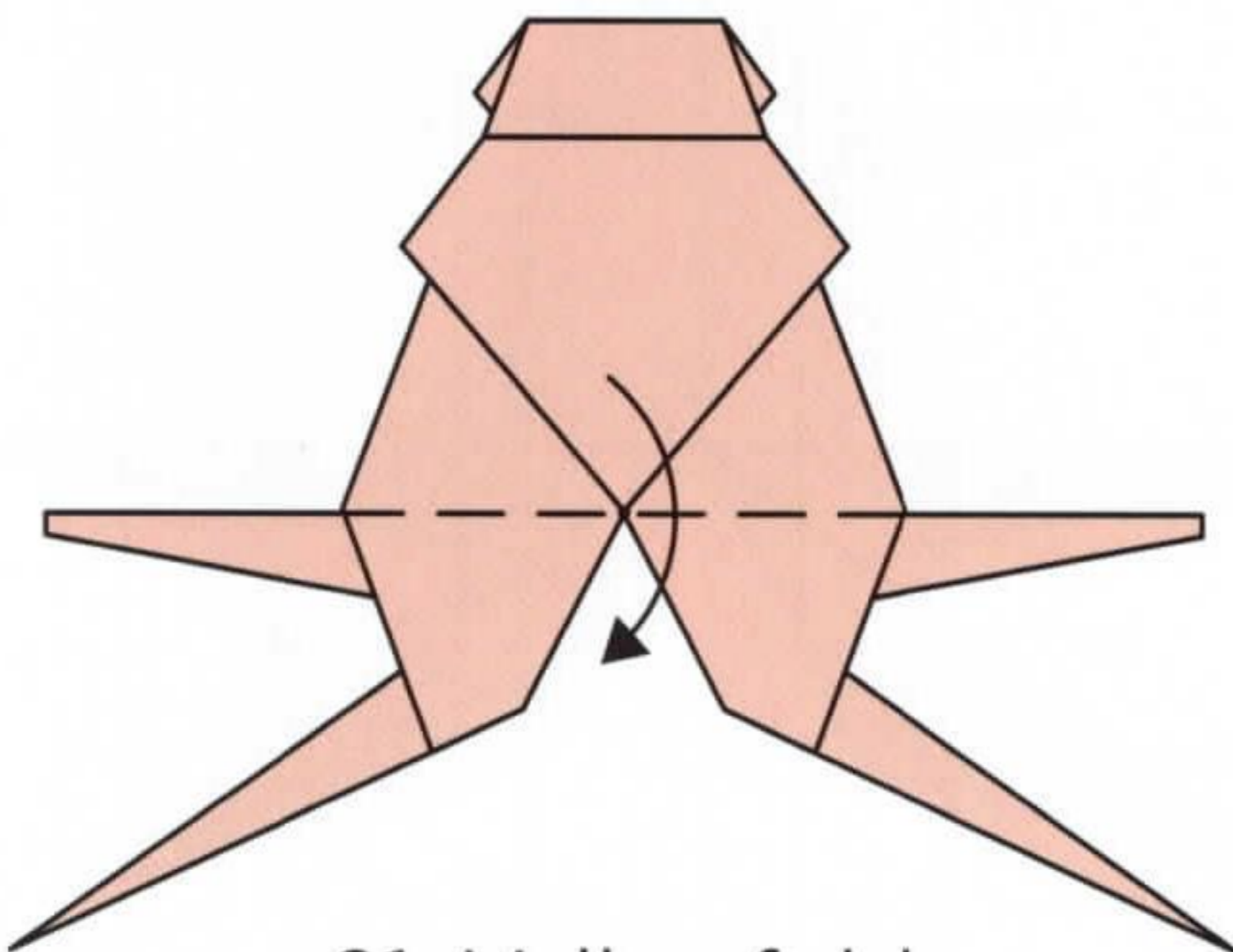

21. Valley fold

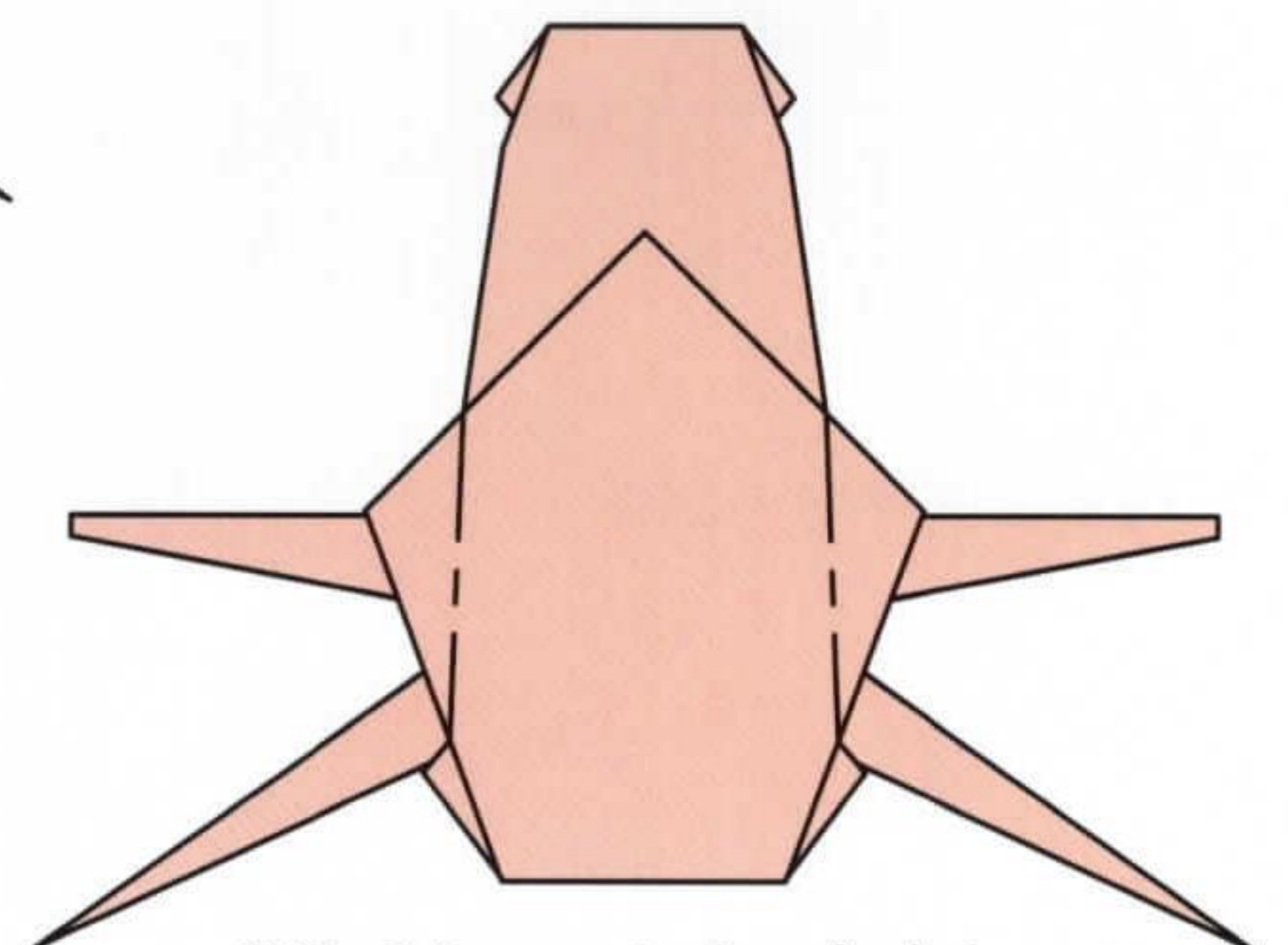

22. Mountain folds and tuck-in between the back layers

dinette chair

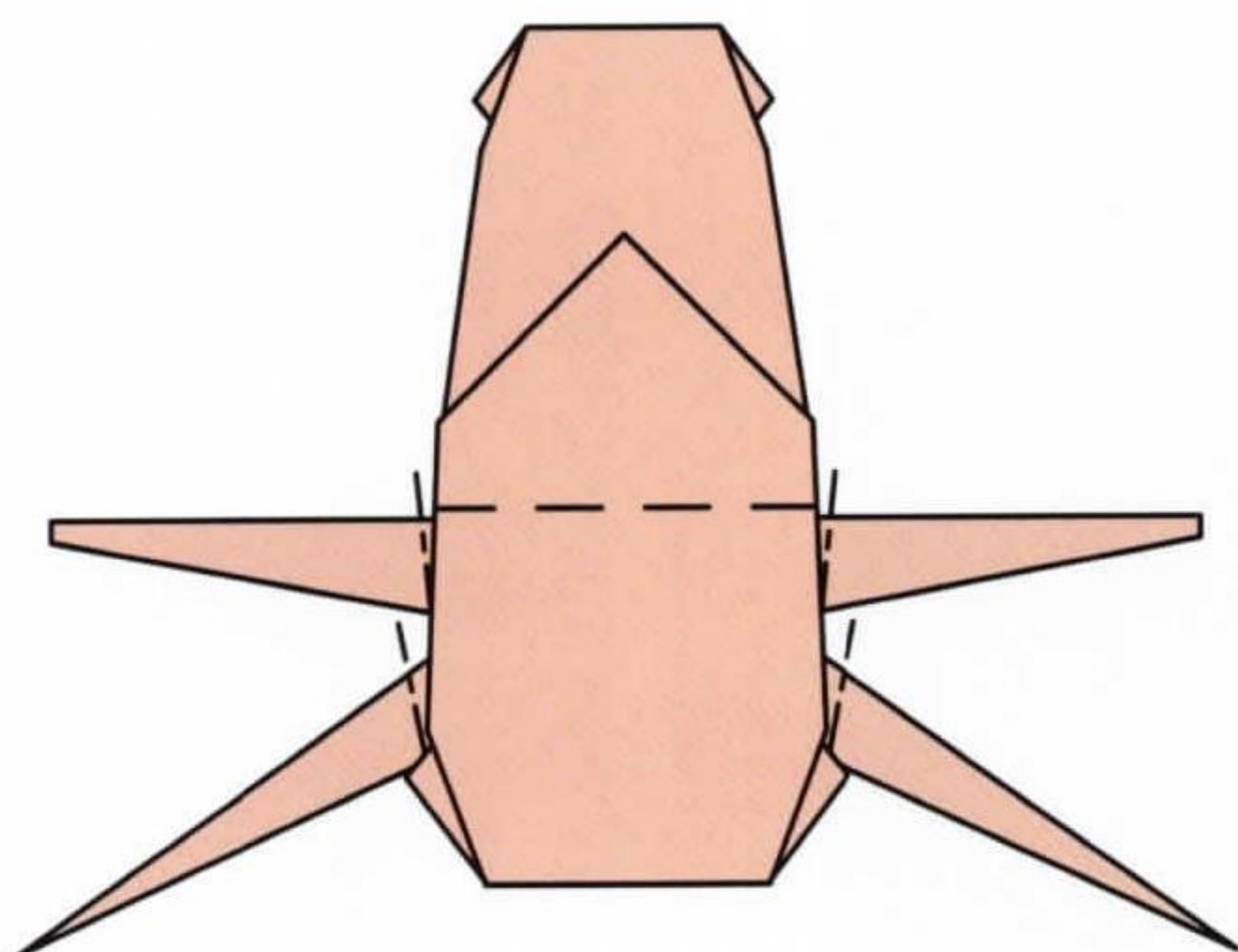

23. Valley fold the front and Mountain fold the back

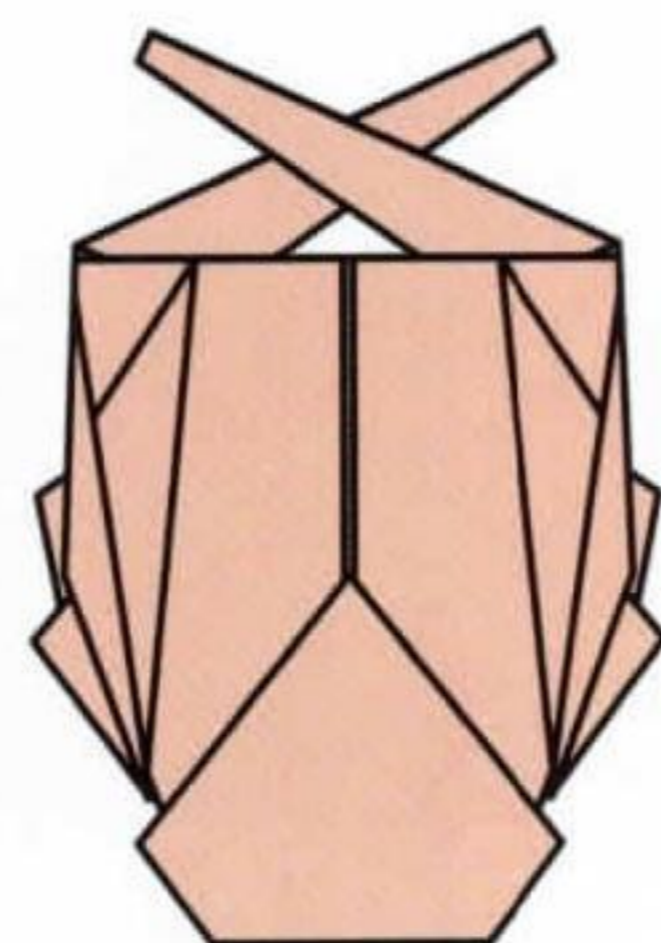

24. Unfold to form a chair

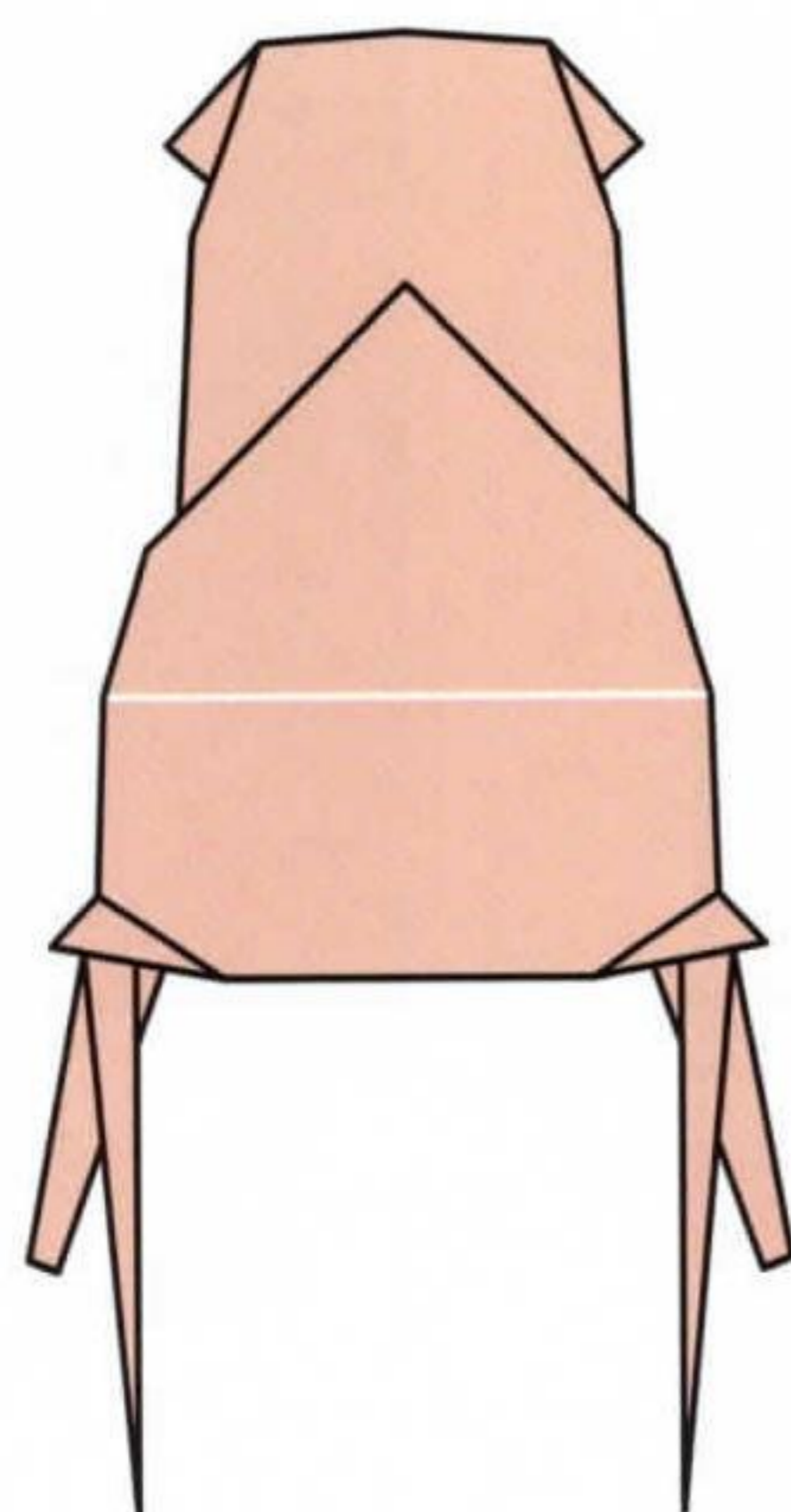

25. Completed
DINETTE CHAIR



► dinette table

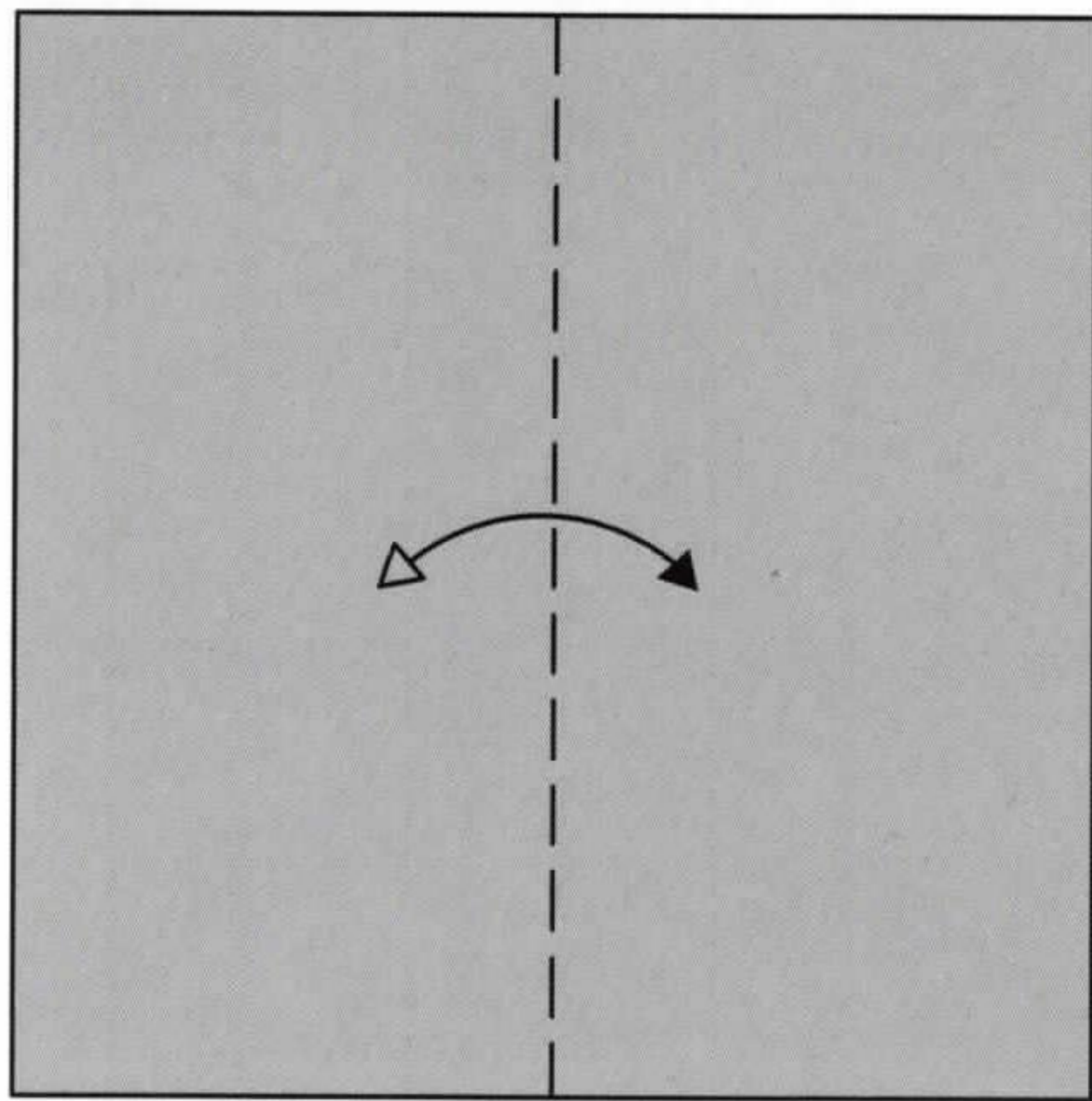

1. Valley fold and unfold

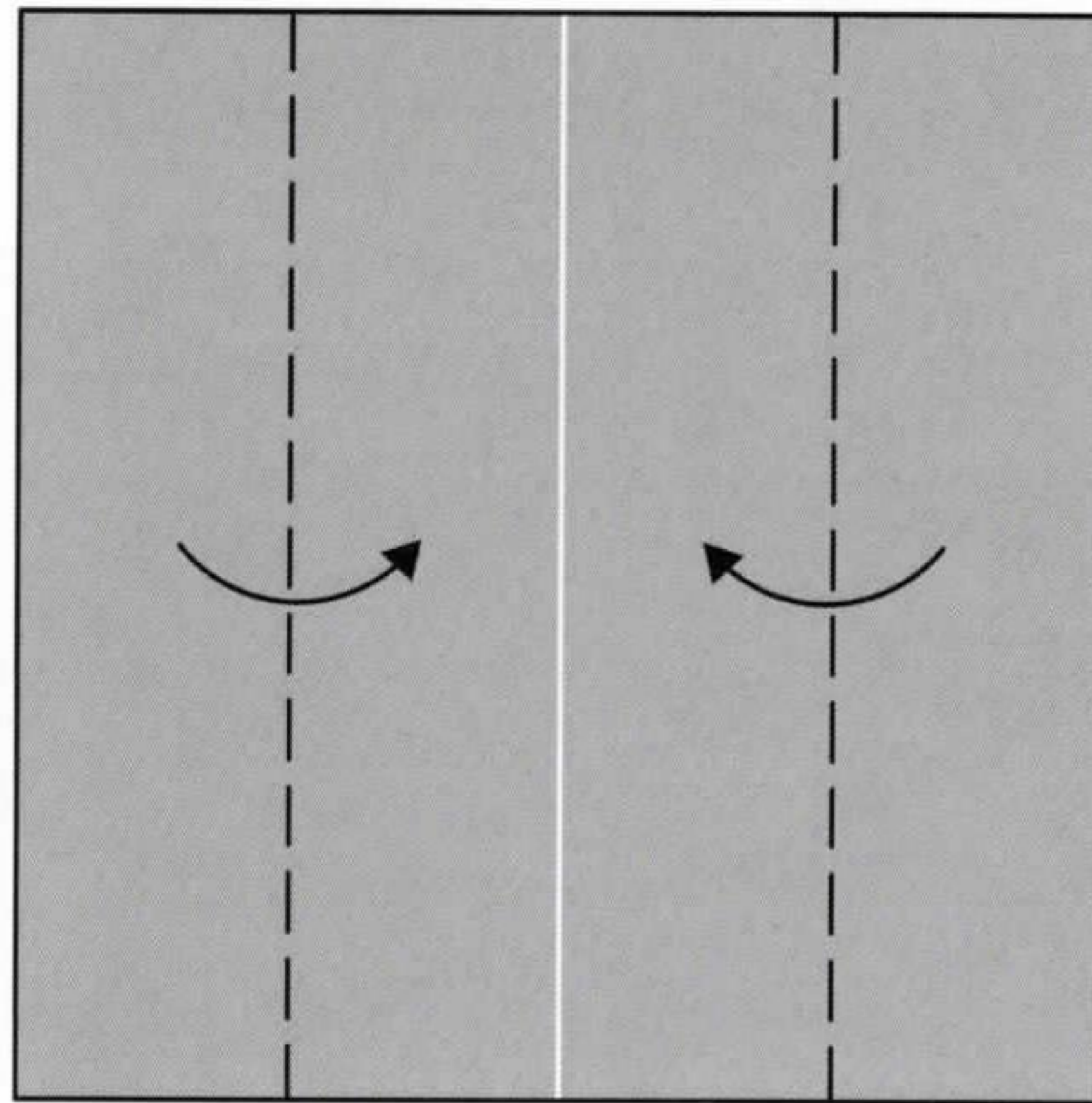

2. Valley folds

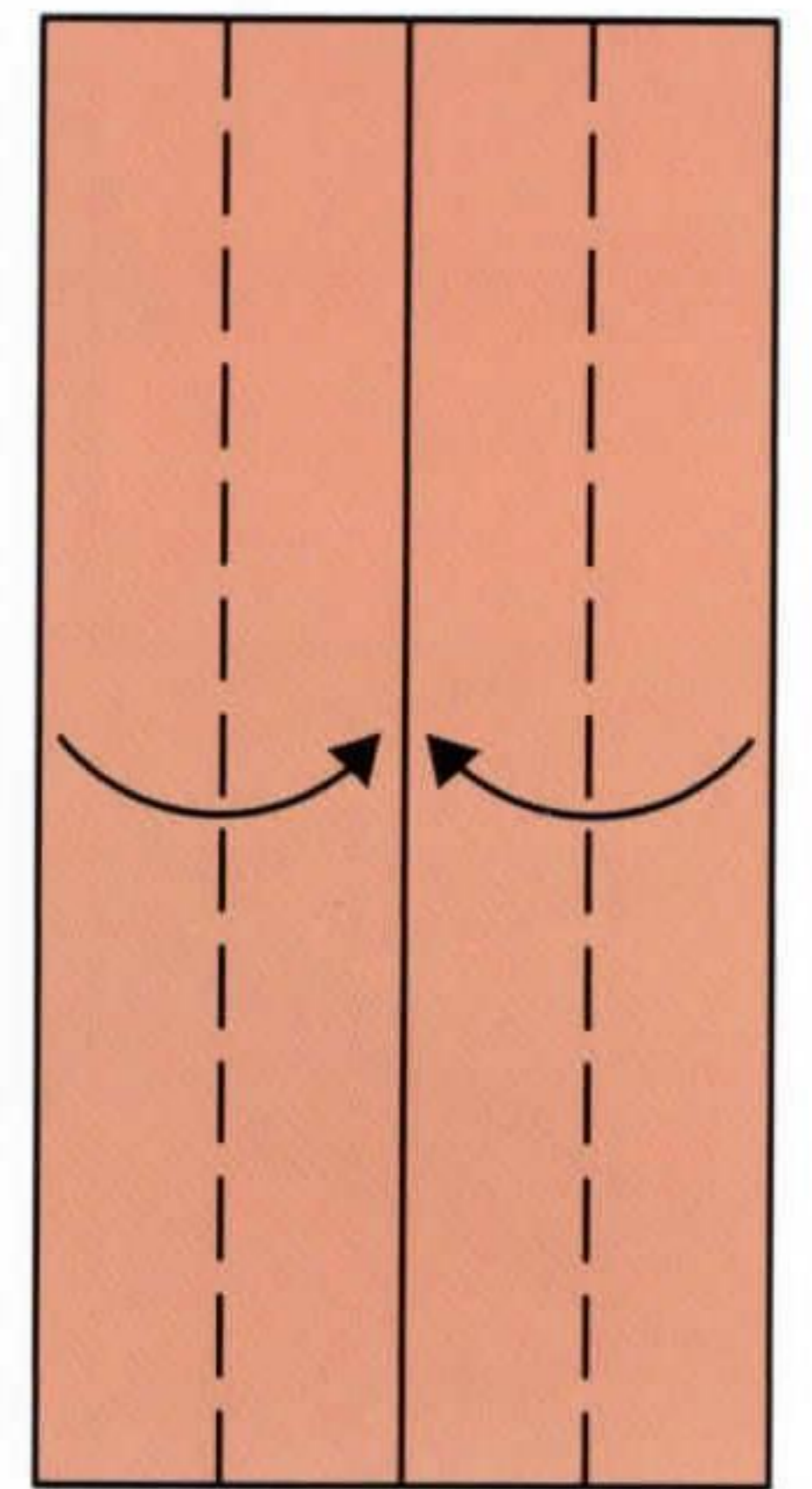

3. Valley folds

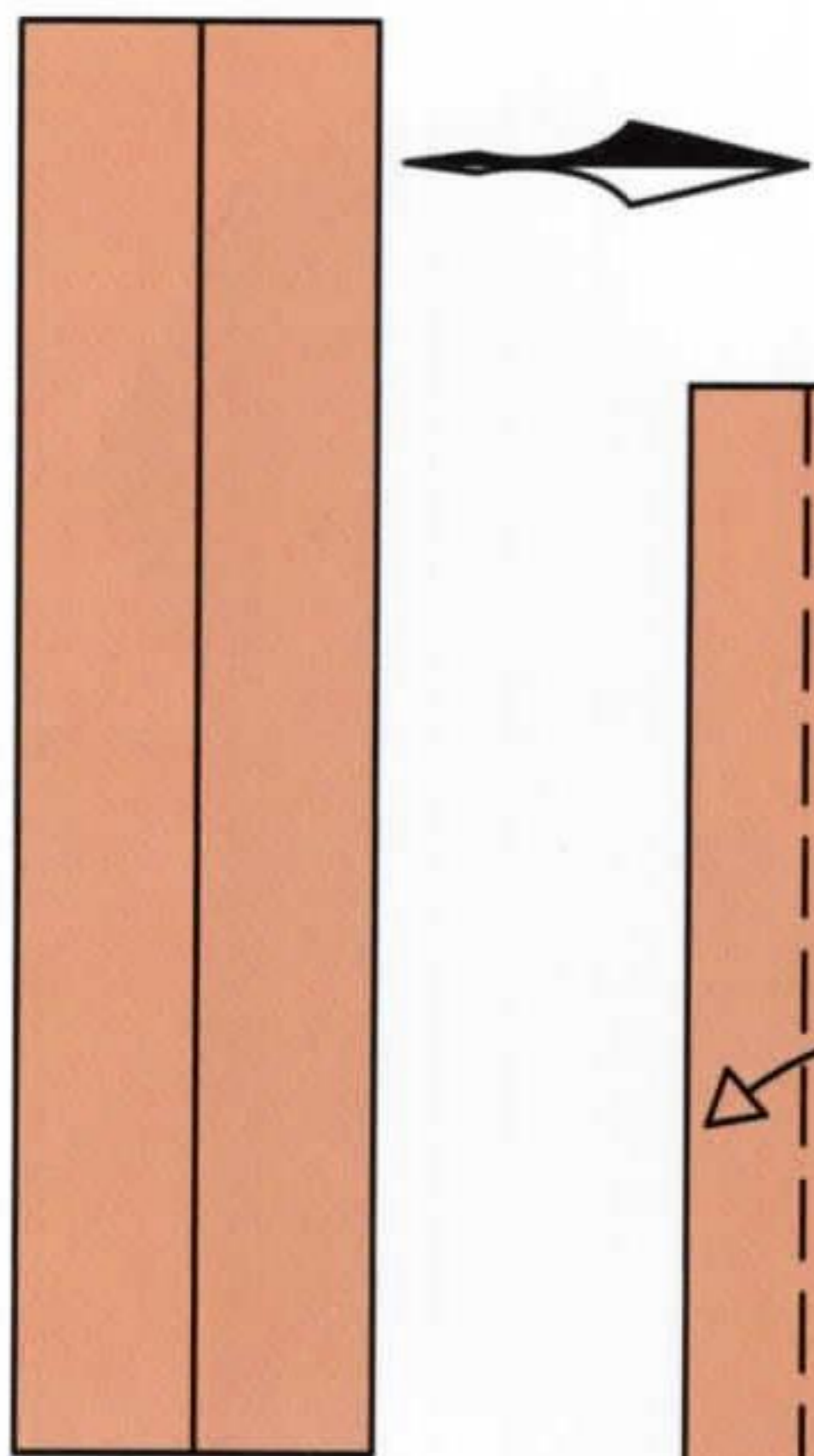

4. Scale-up

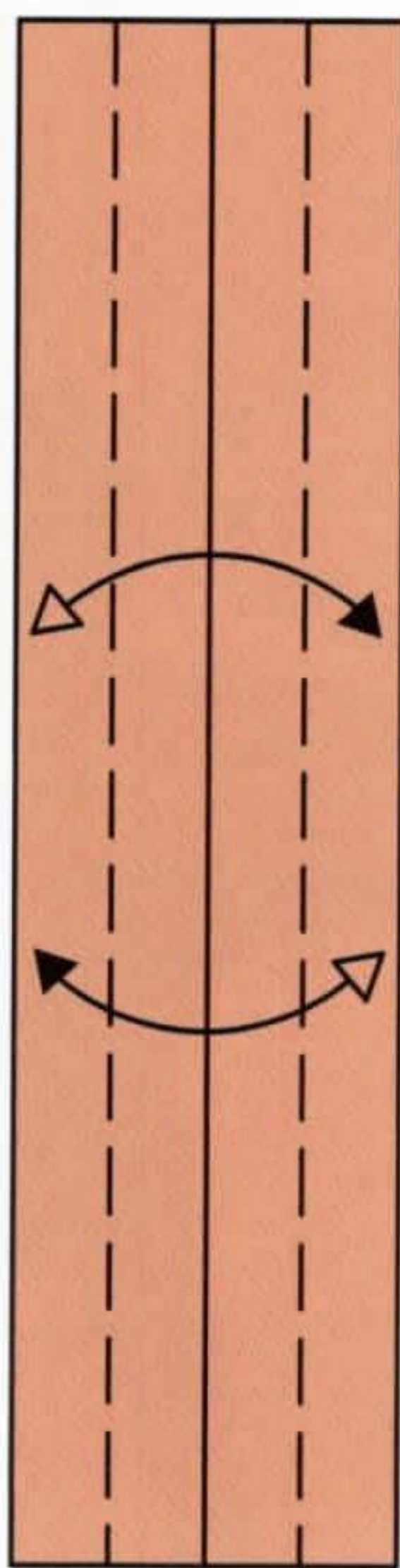

5. Valley folds and unfold

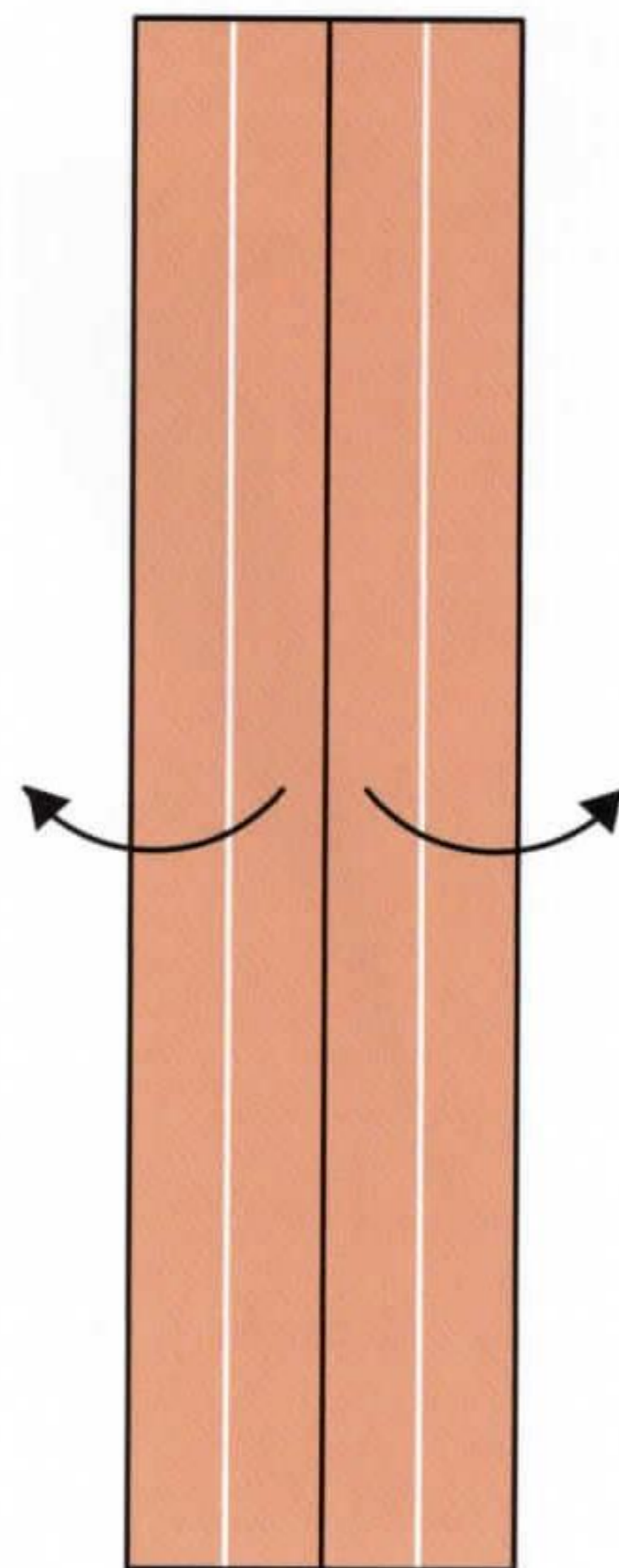

6. Valley folds

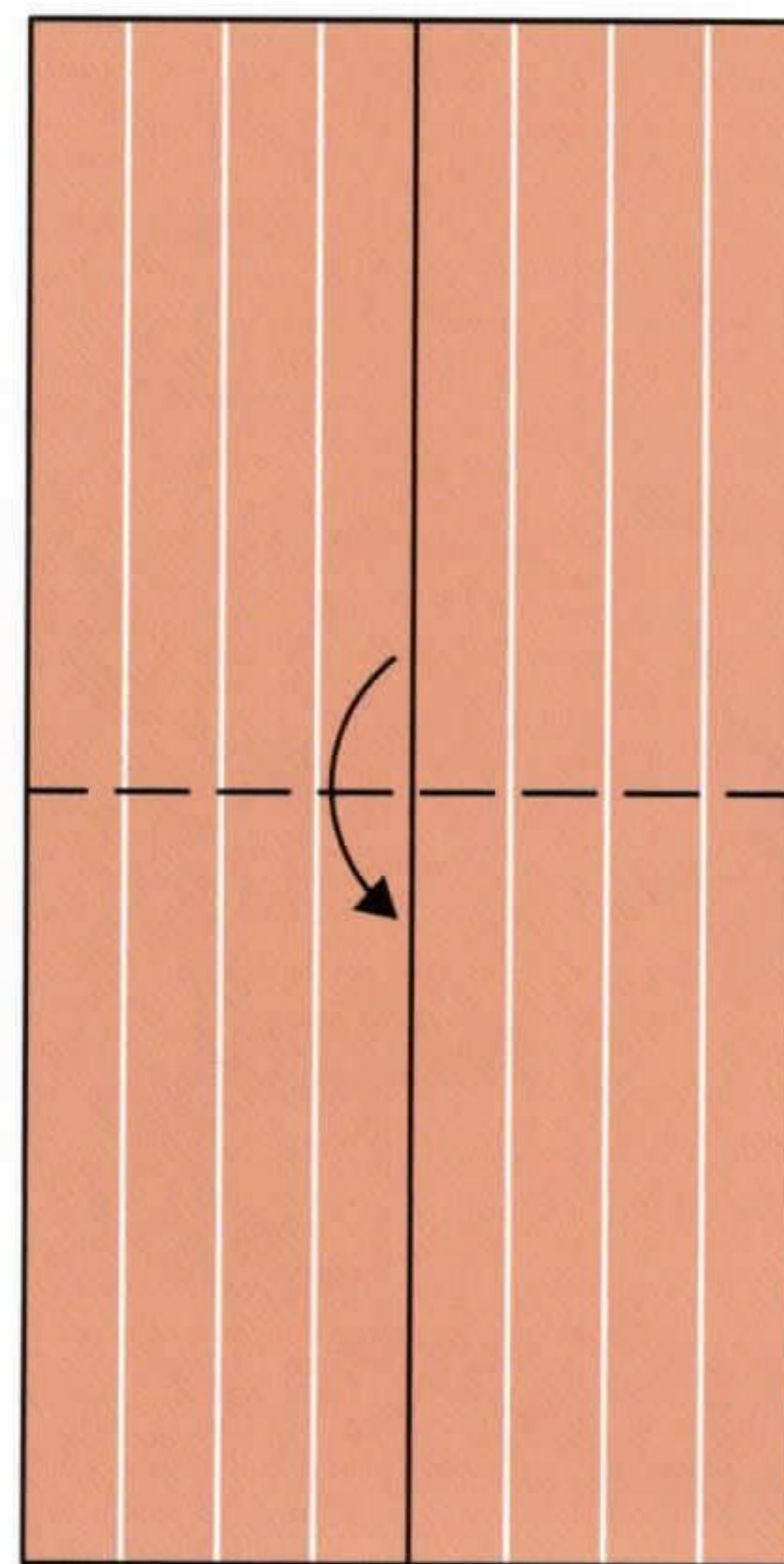

7. Valley fold

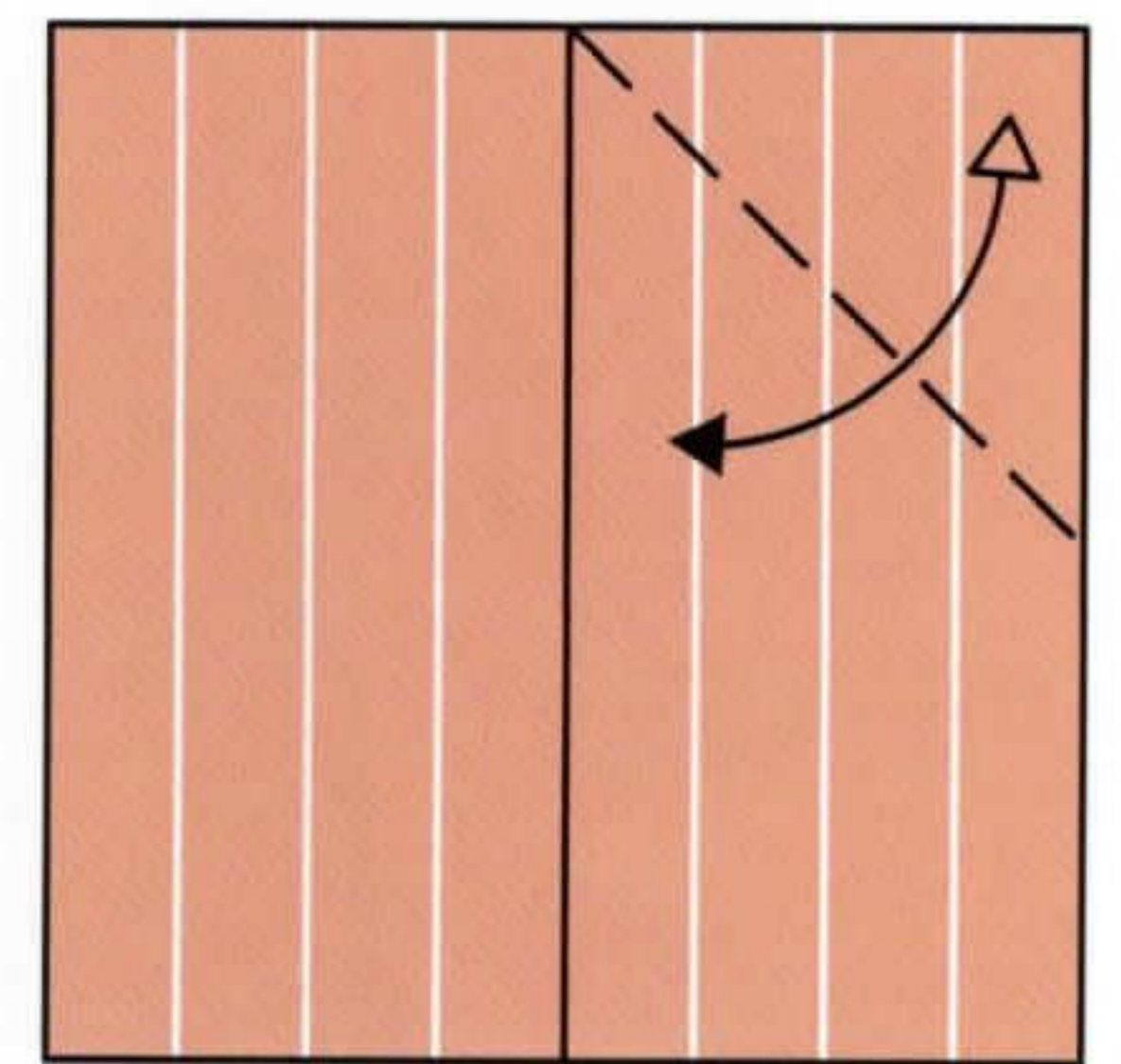

8. Valley fold and unfold

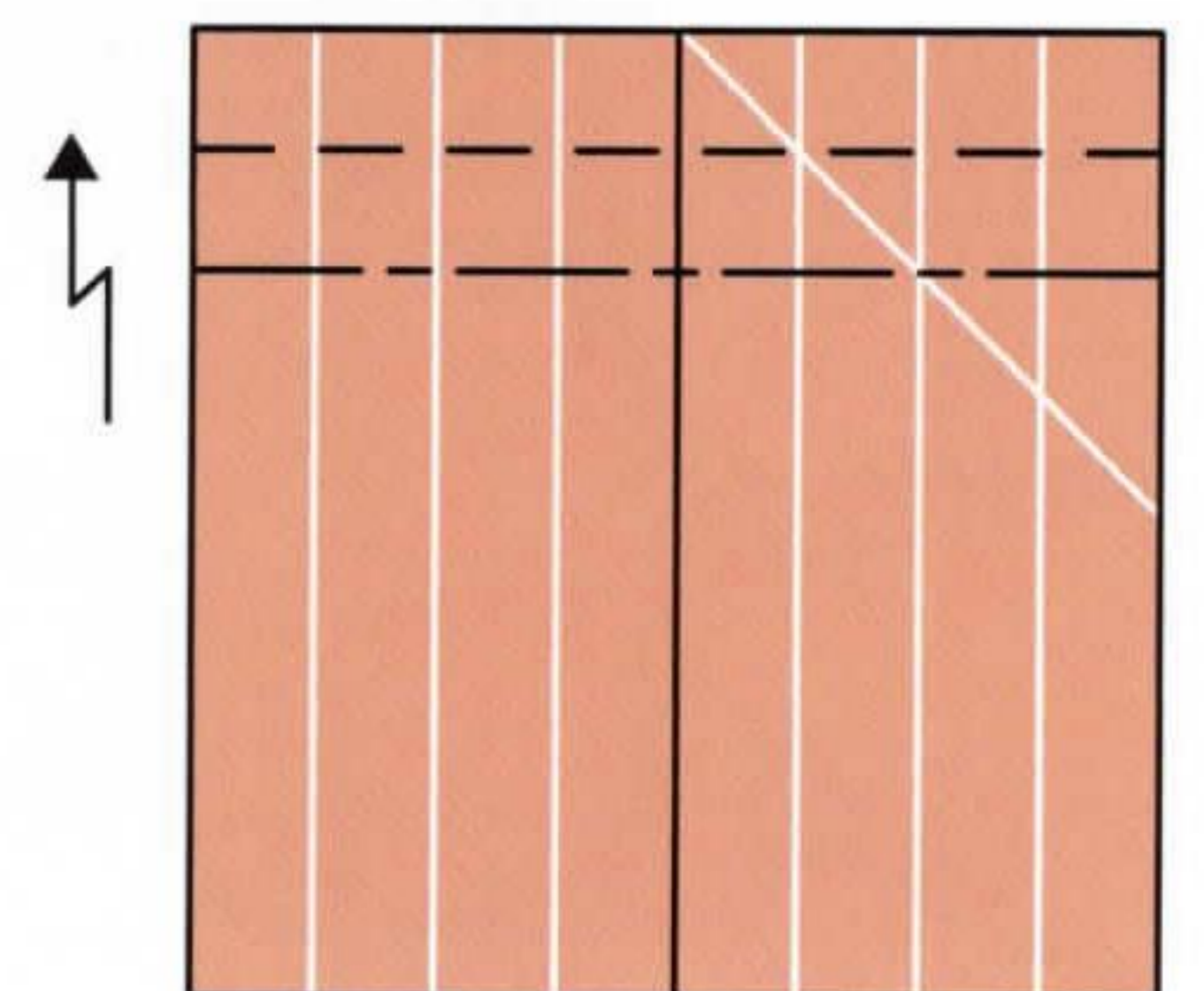

9. Pleat fold

dinette table

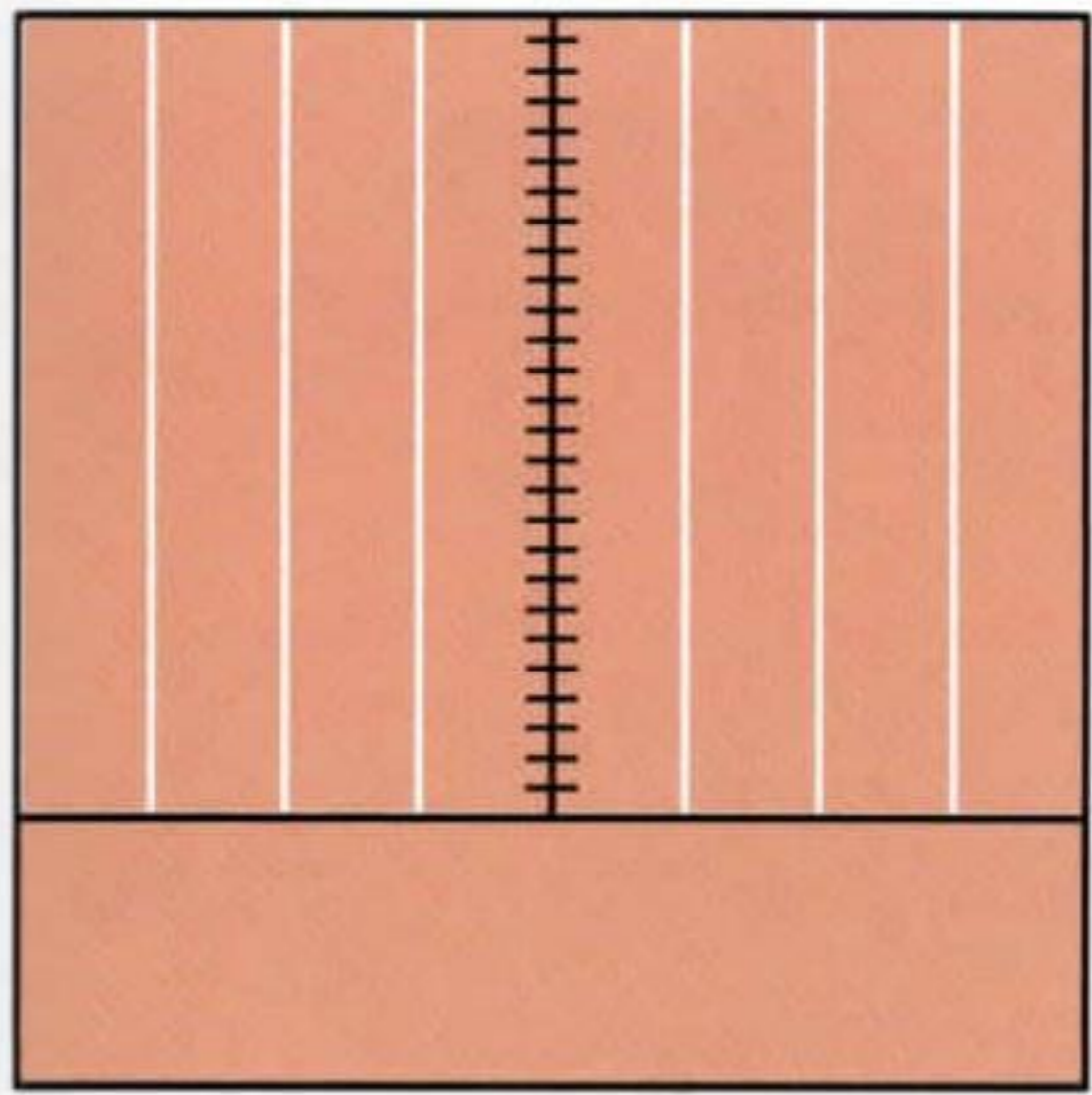

10. Cut as shown

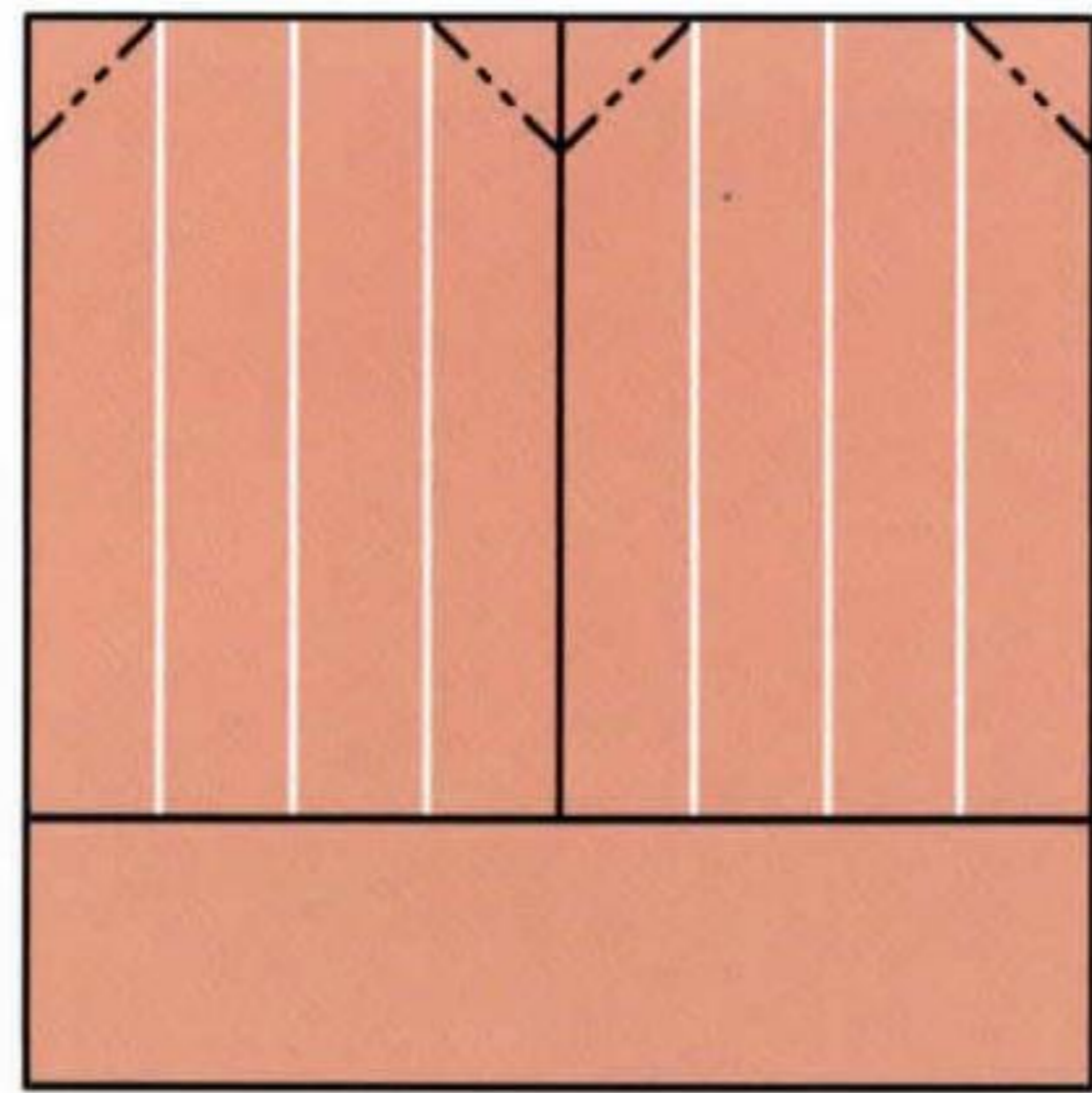

11. Inside reverse folds

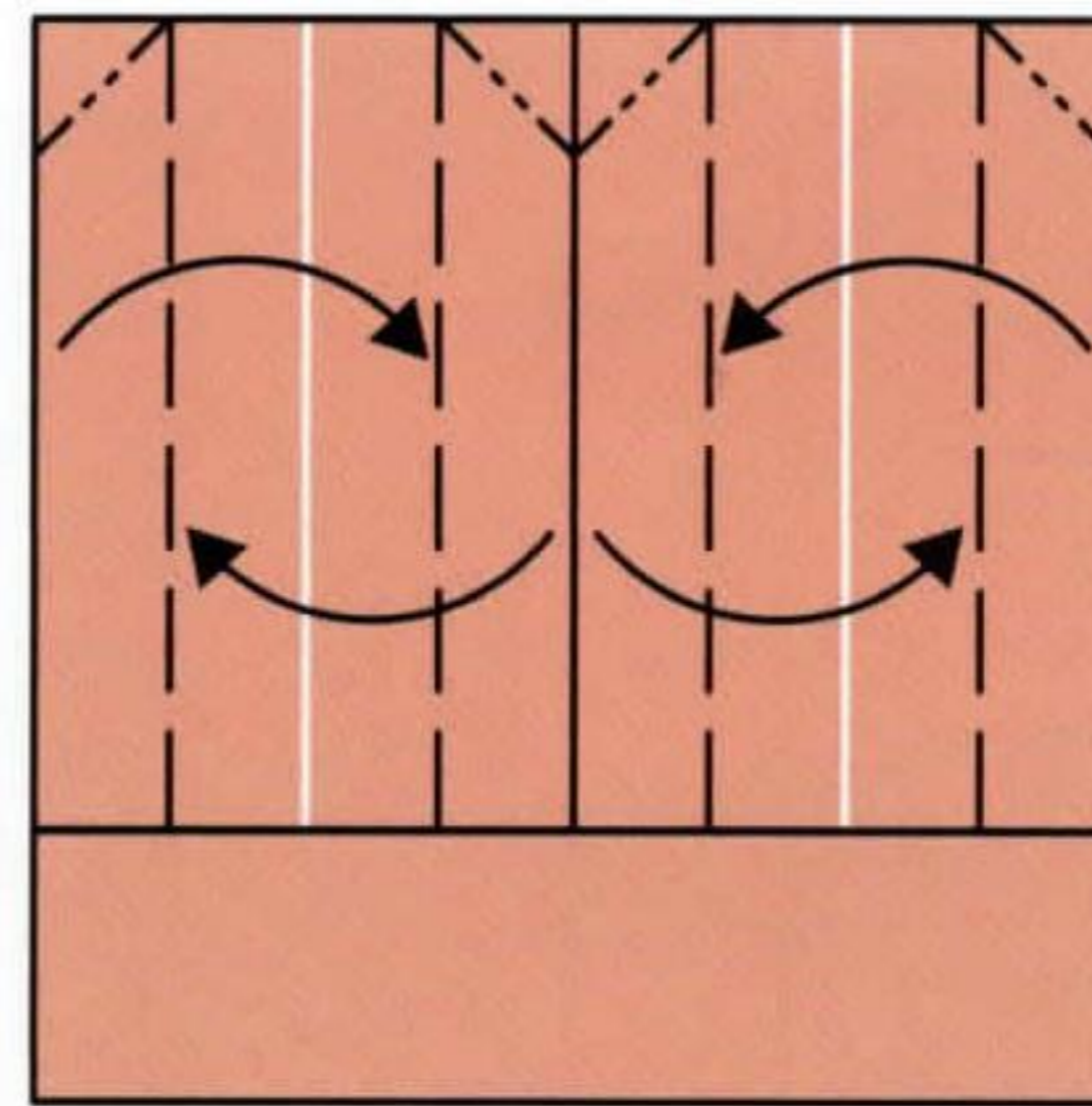

12. Inside reverse folds then, Valley folds

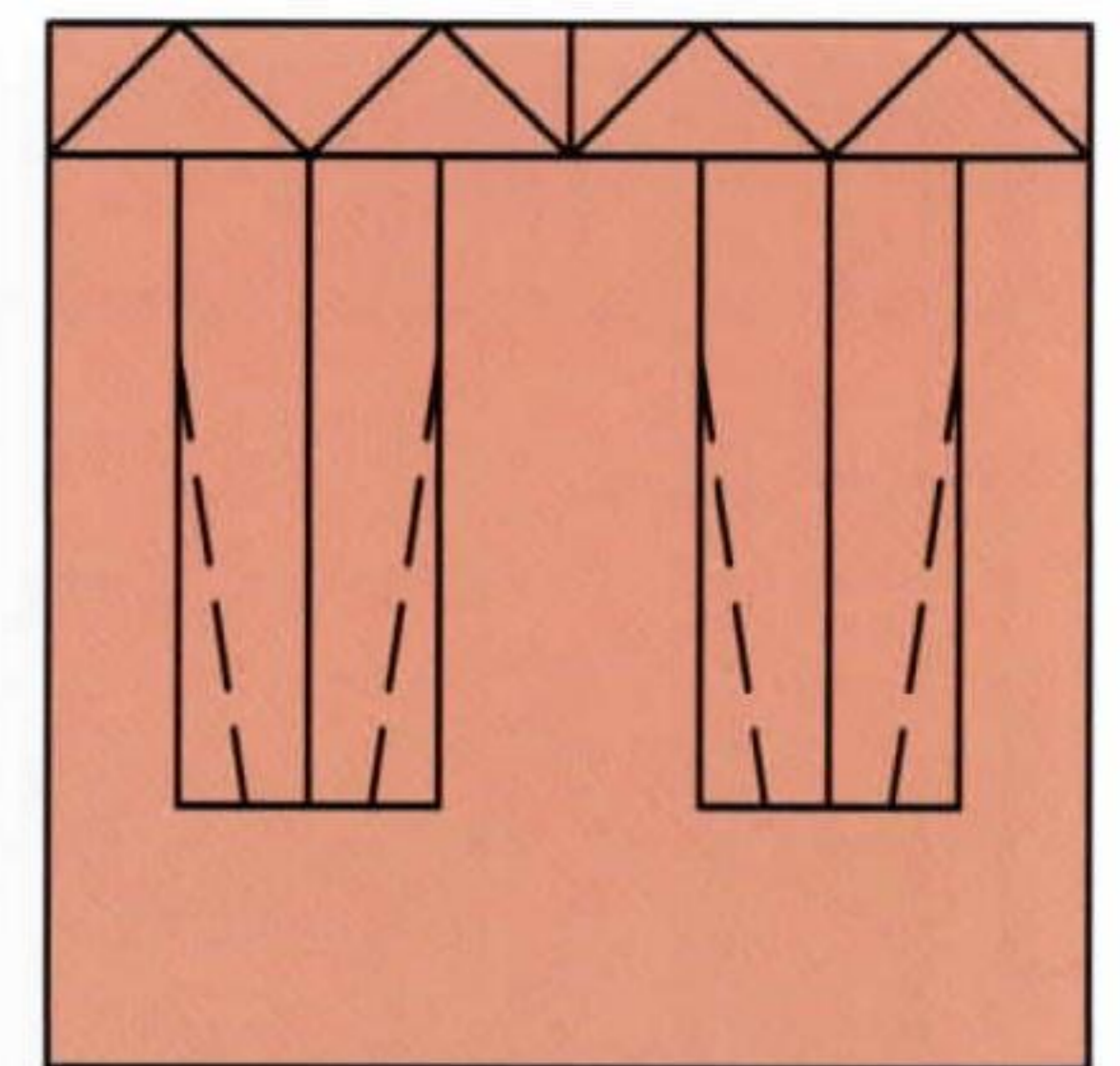

13. Valley folds

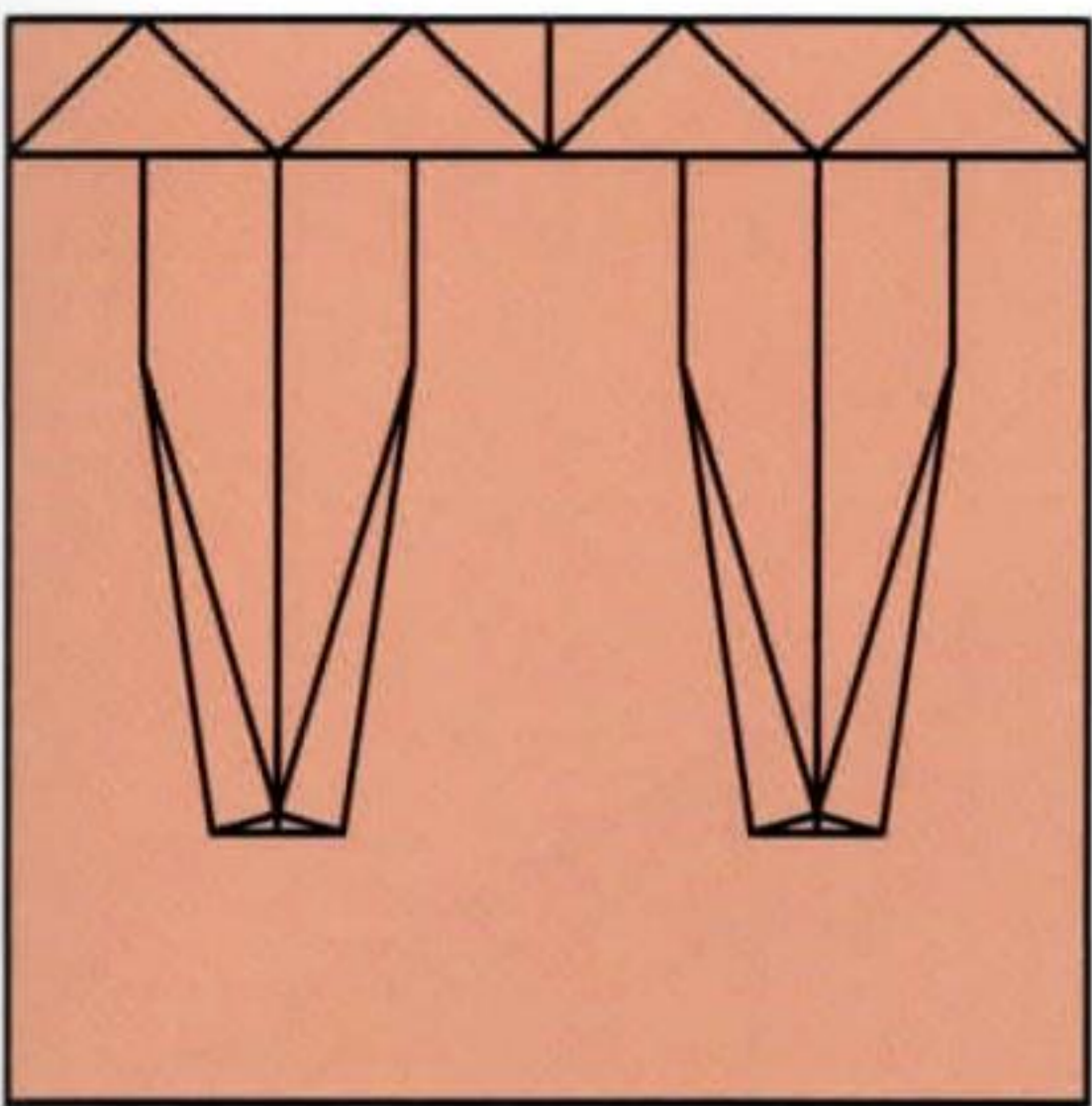

14. Rotate

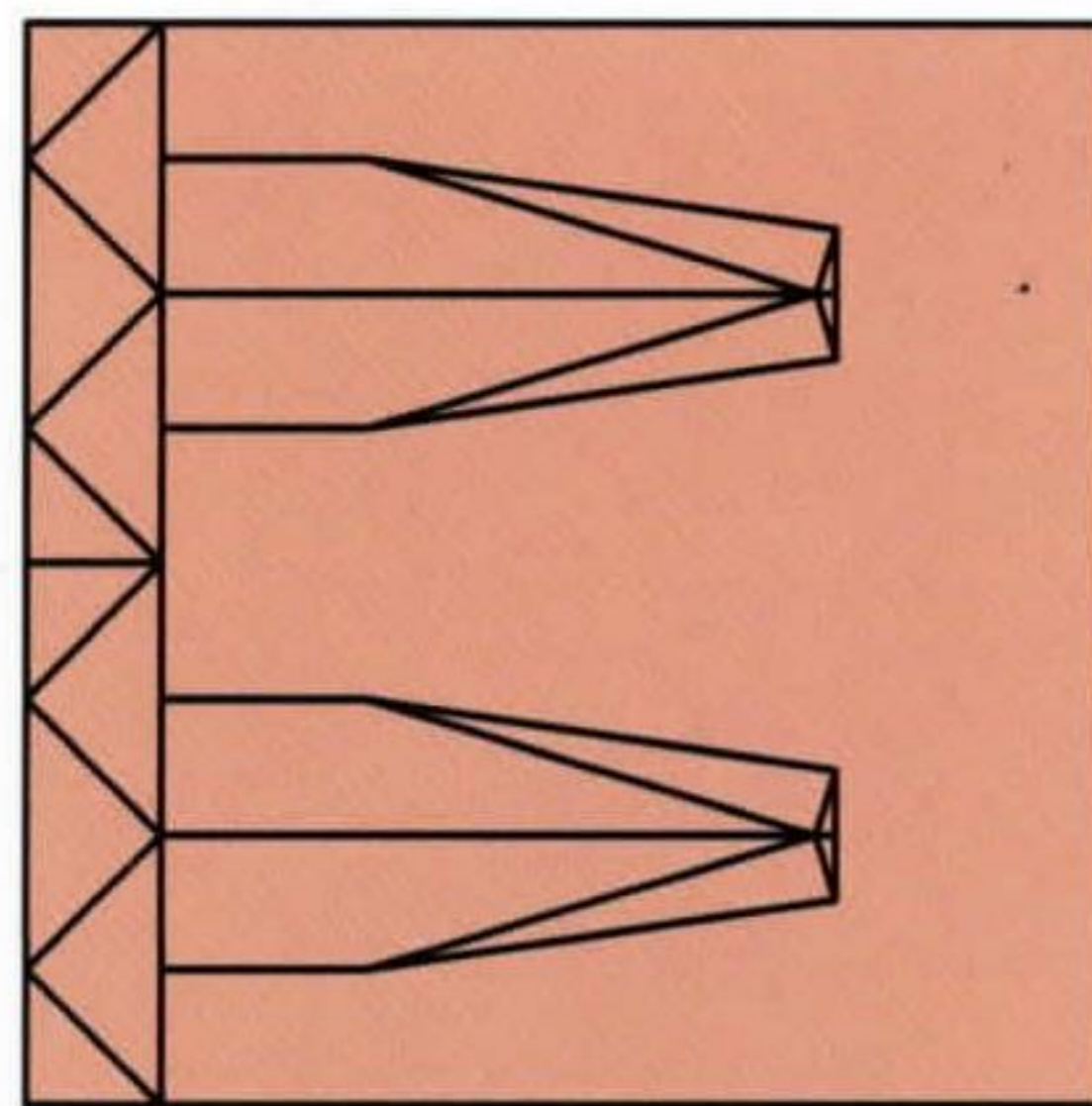
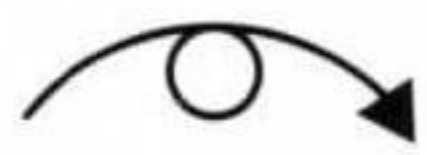

15. Turn over

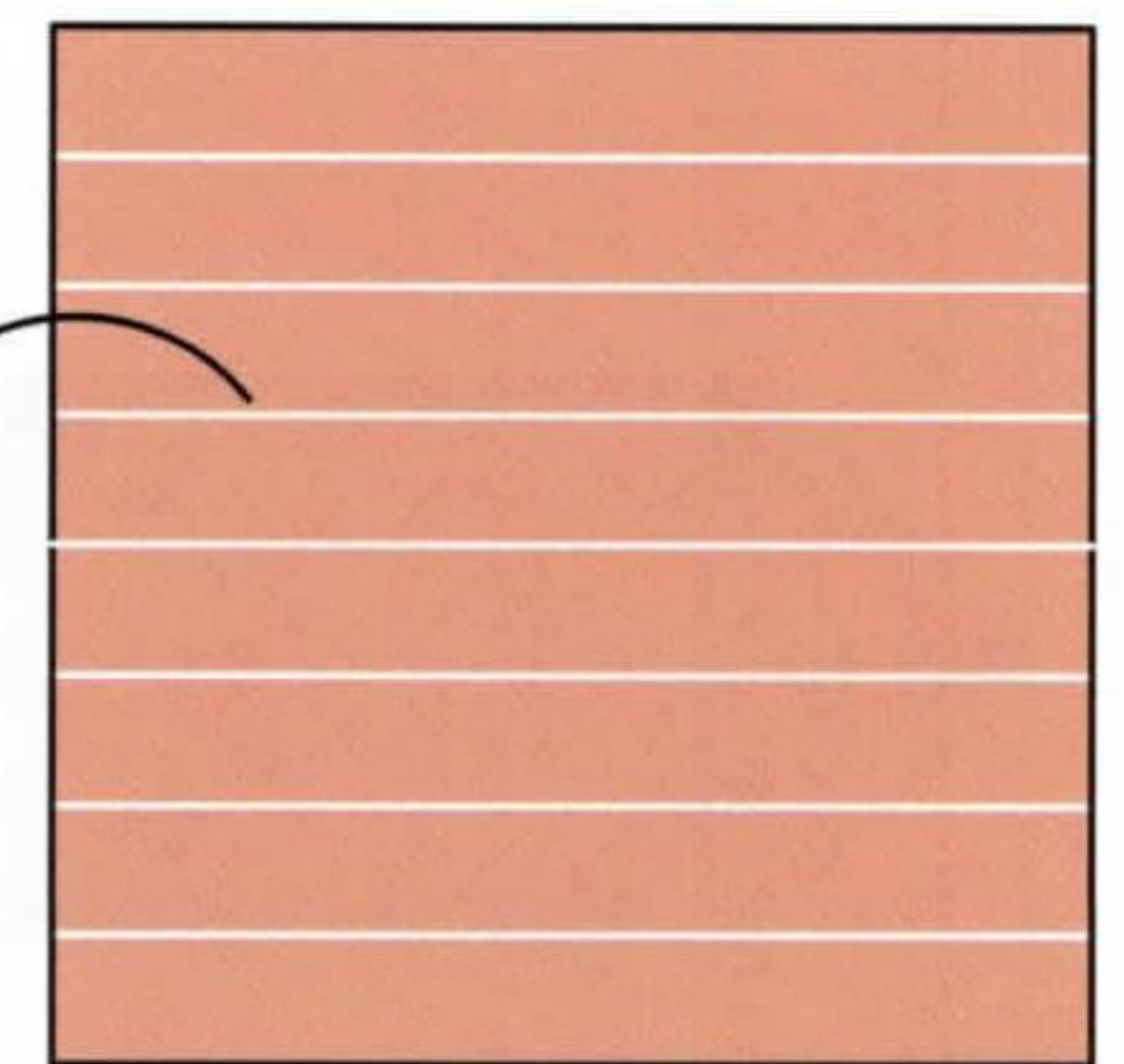

16. Valley fold

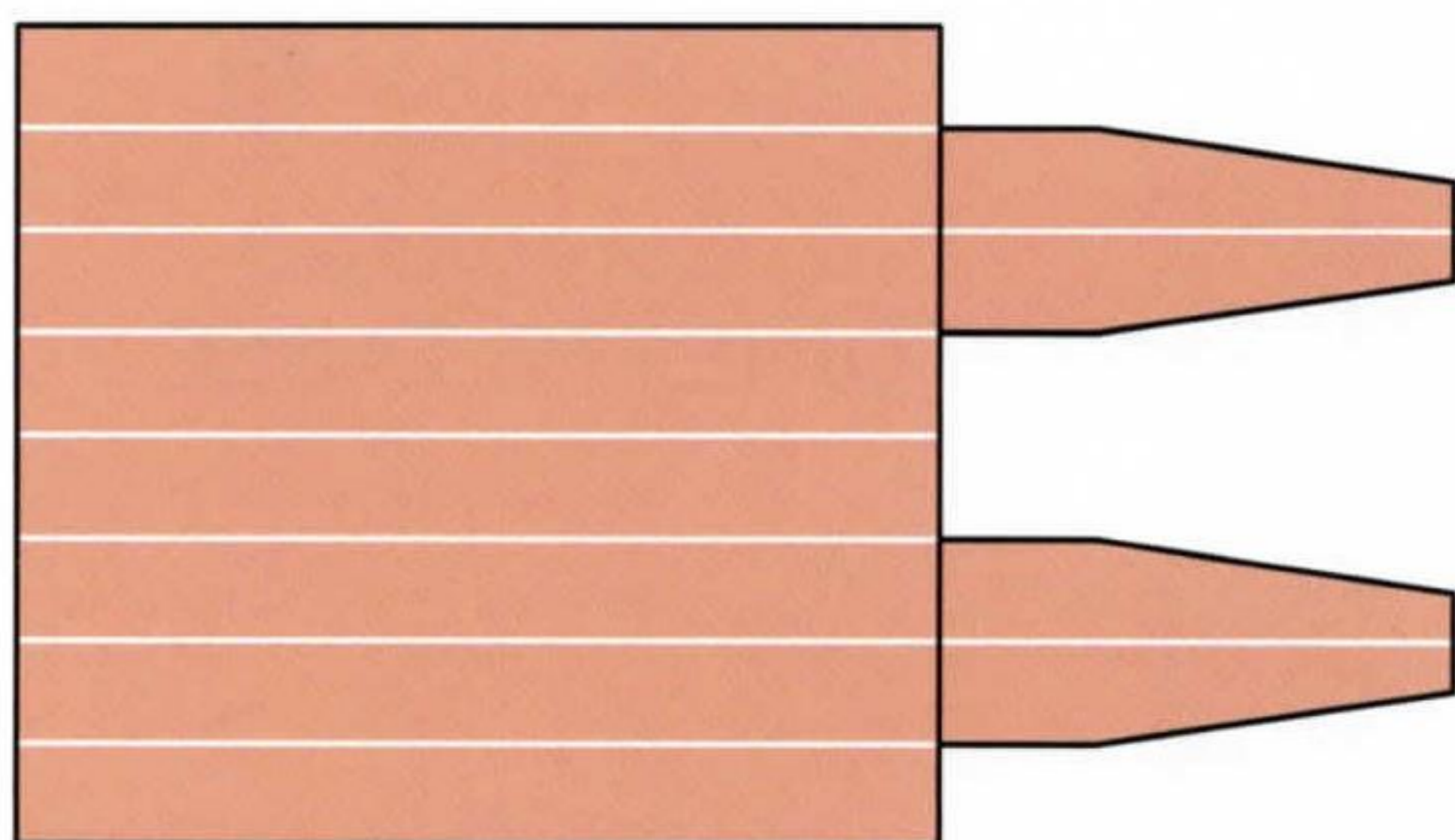

17. Turn over to the other side

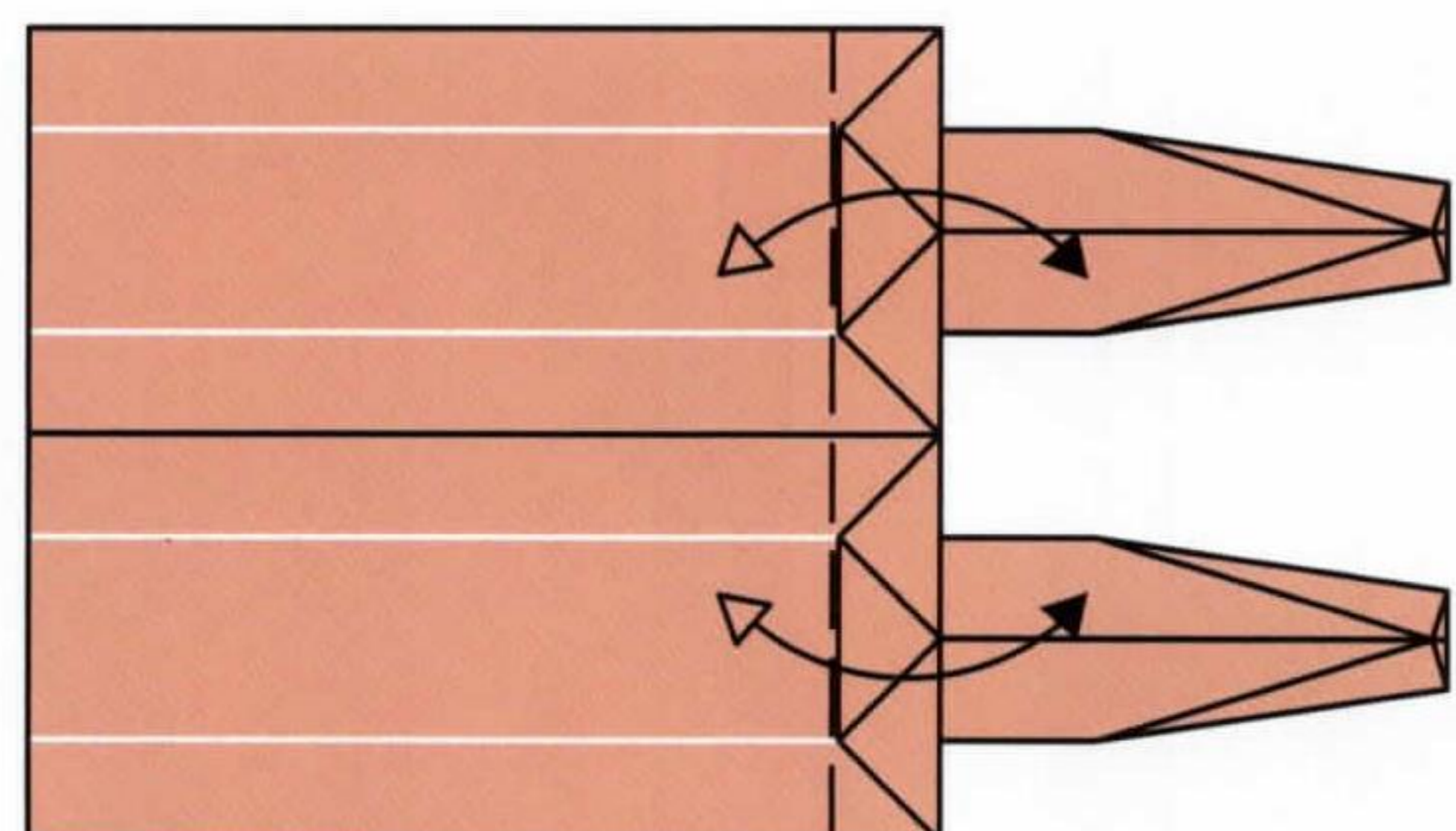

18. Valley folds and unfold

dinette table

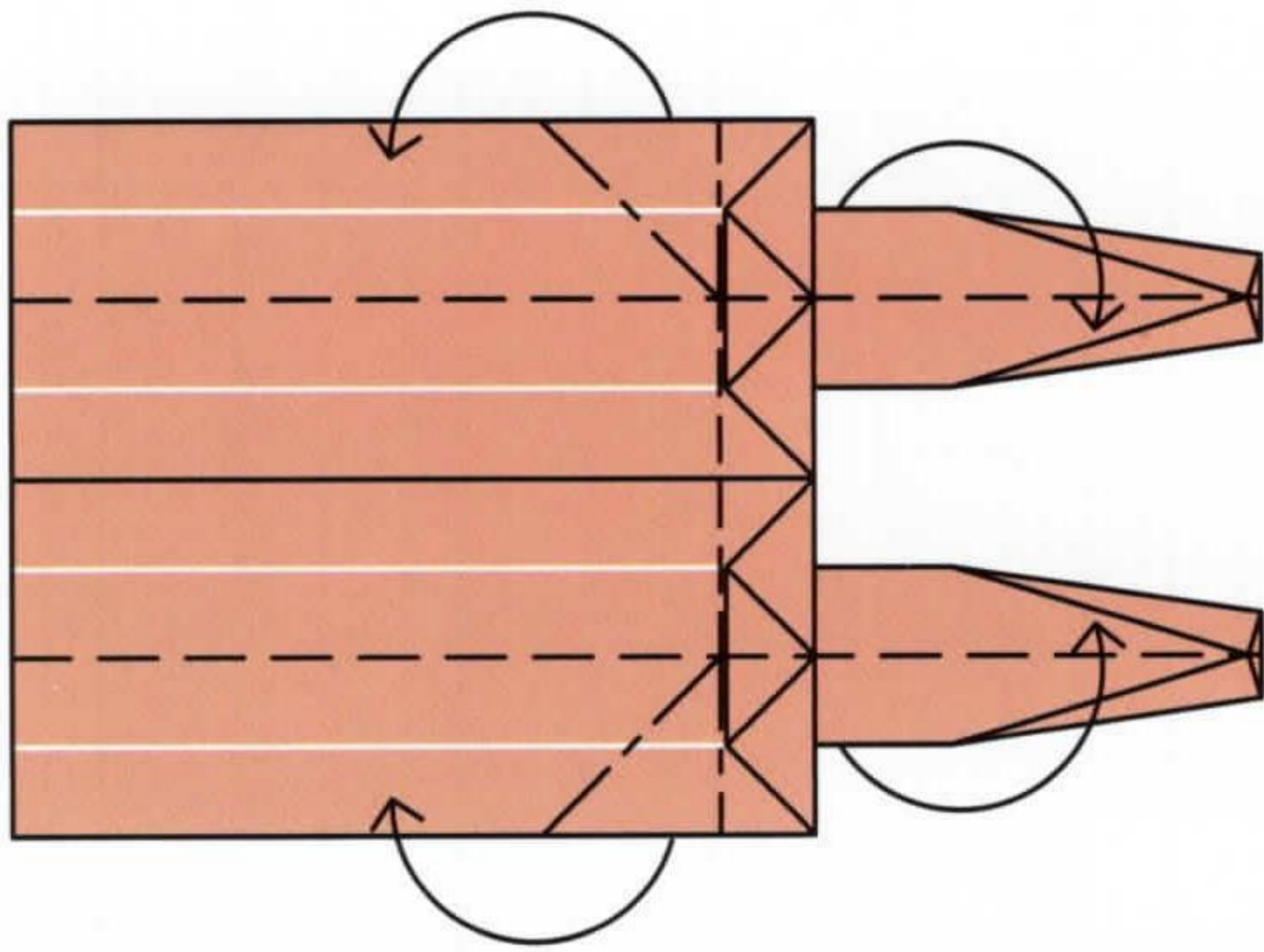

19. Valley folds and squash folds at the same time

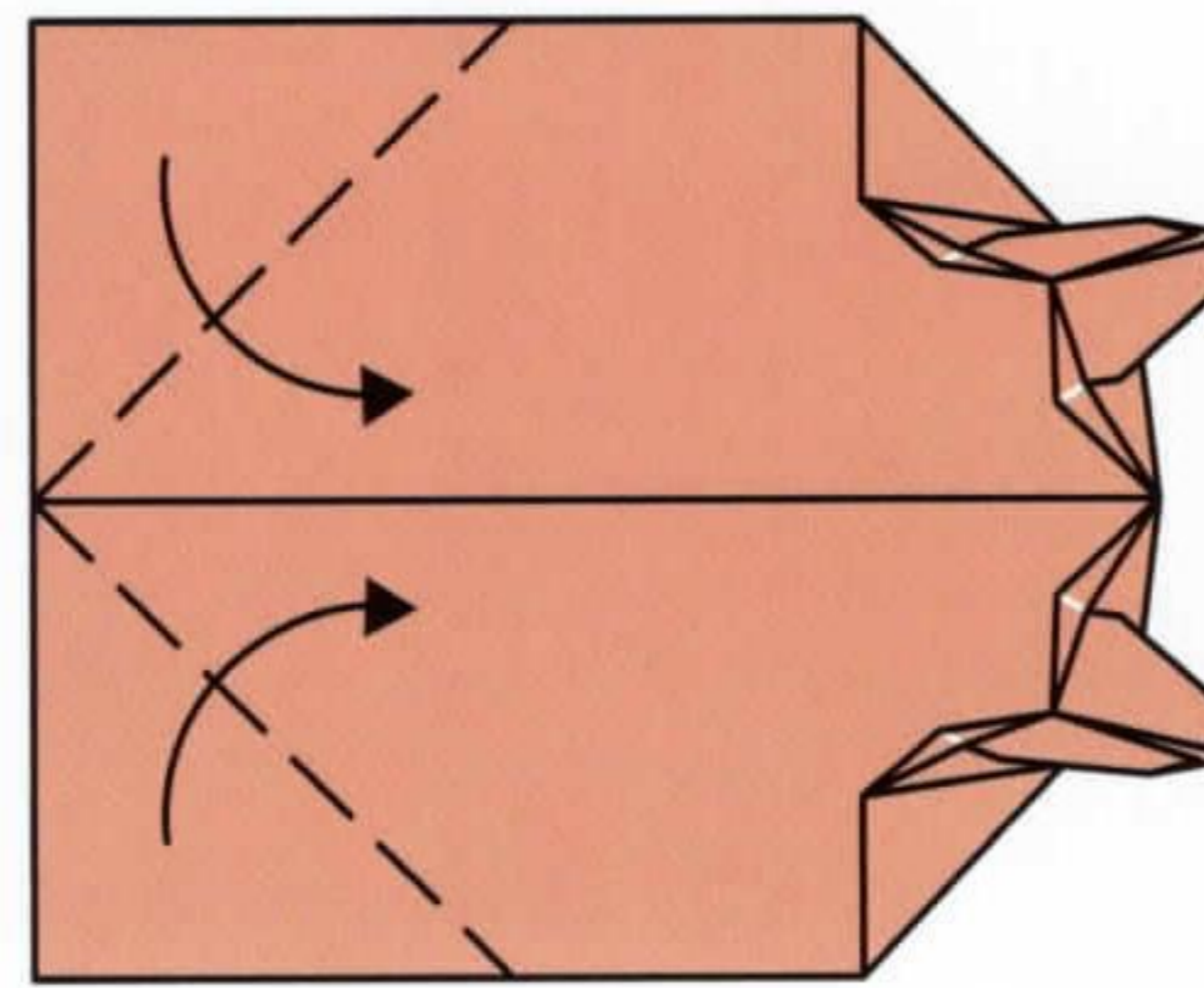

20. Valley folds

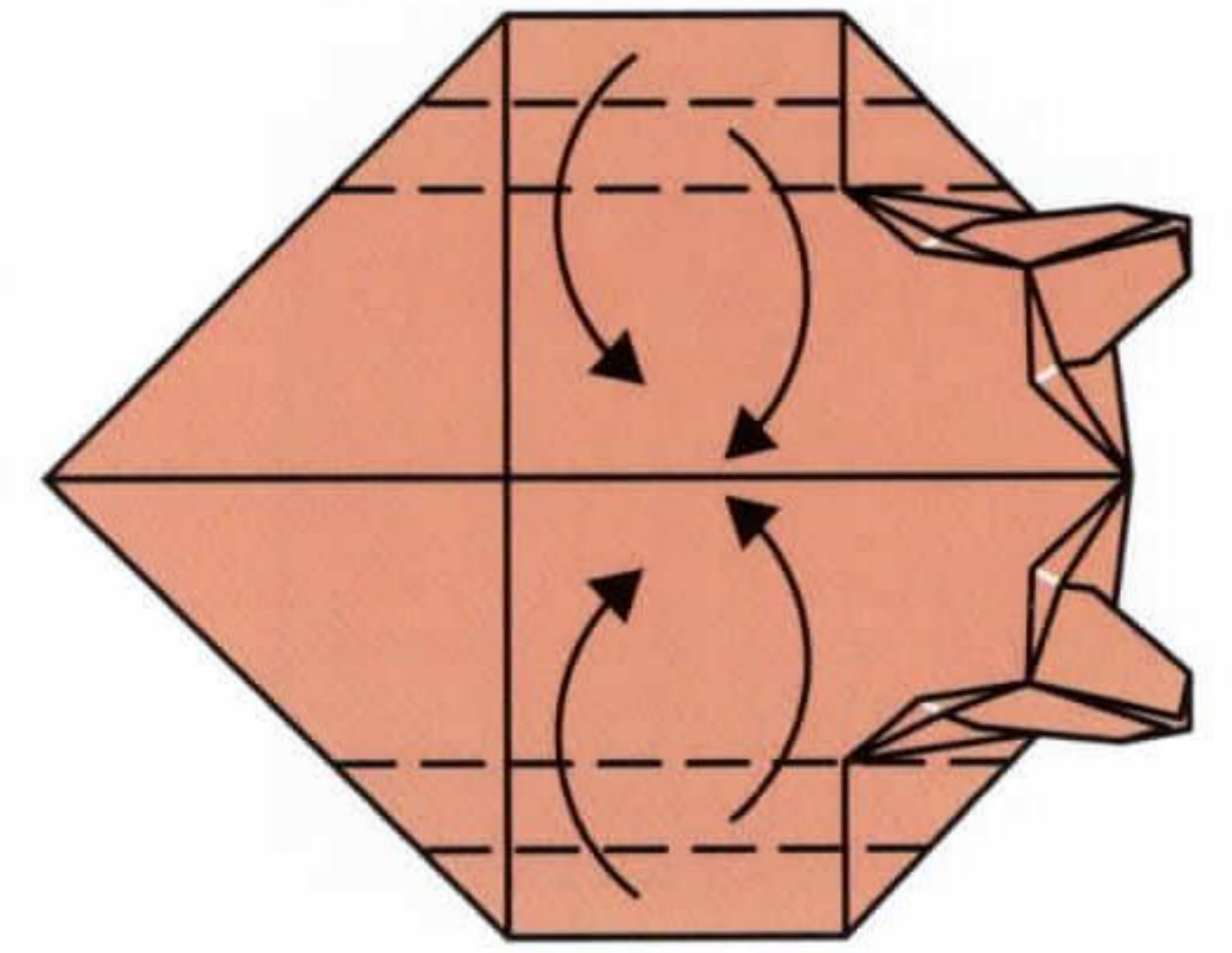

21. Valley folds

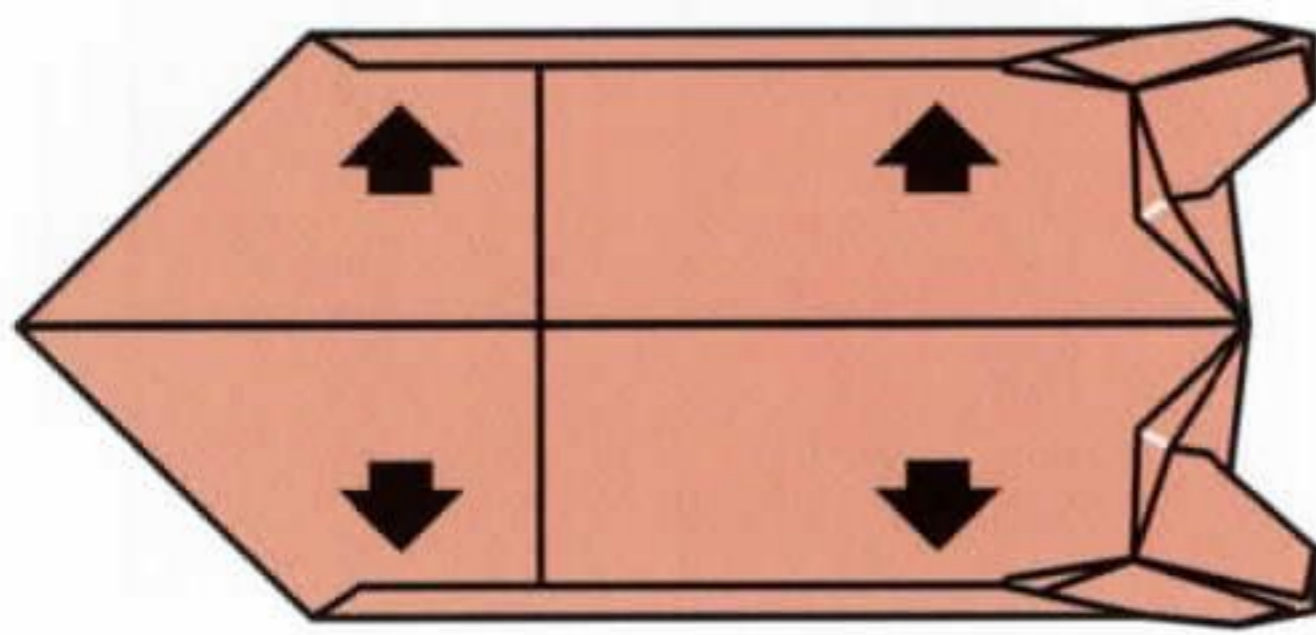

22. Add glue as indicated

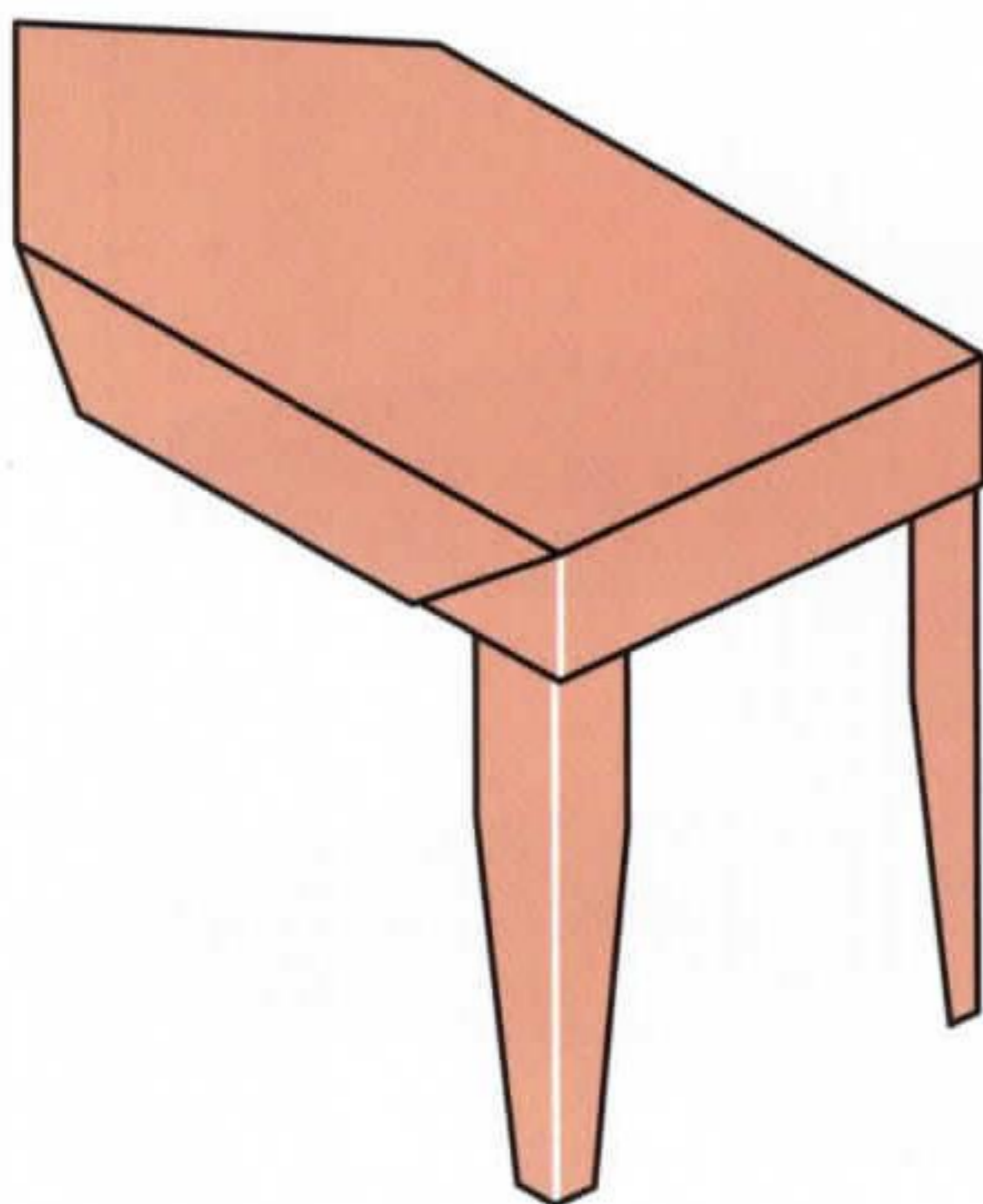

23. Completed PART 1

ASSEMBLY

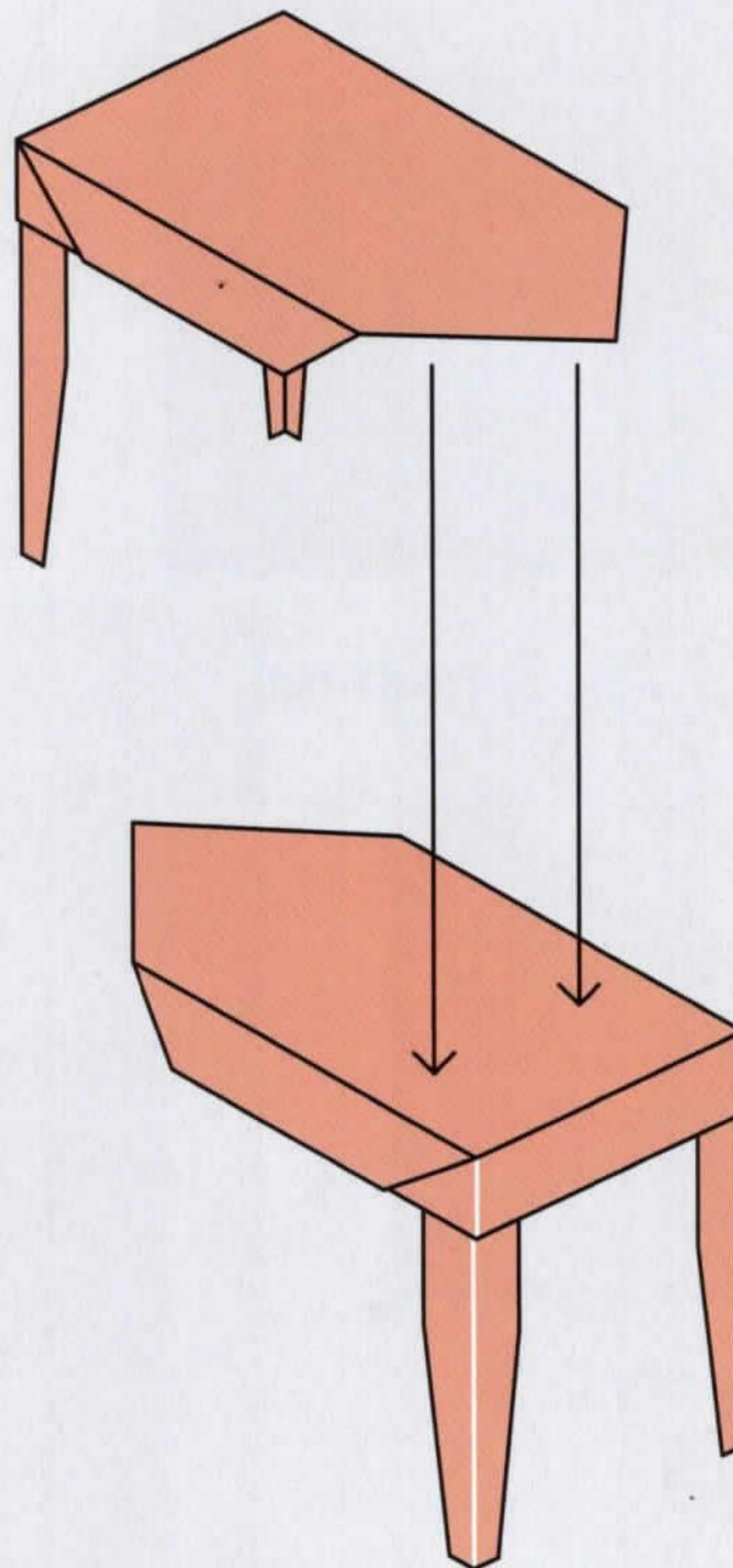

1. Make one more for the assembly as shown and apply glue to hold

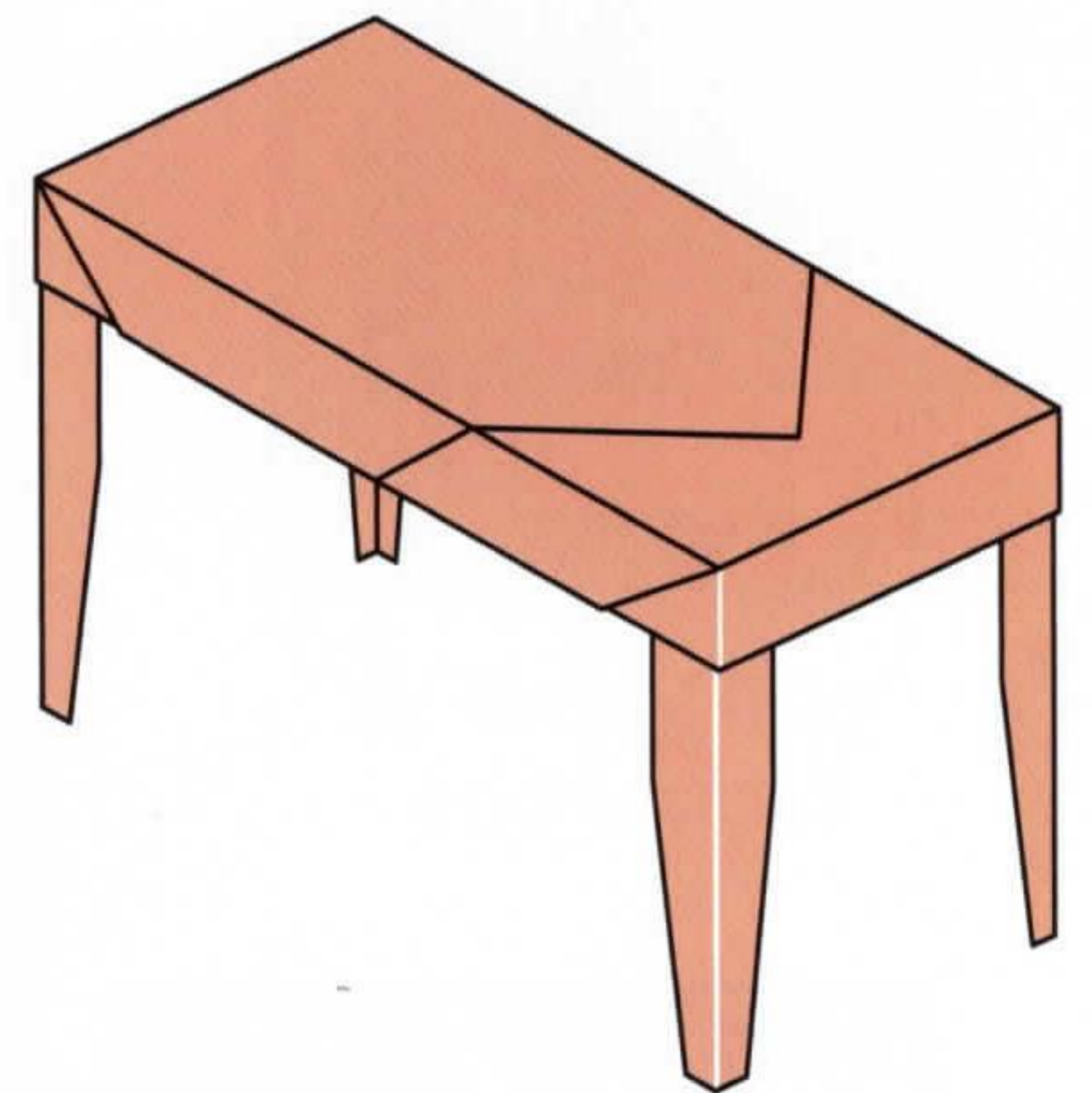

2. Completed DINETTE TABLE

dinette table

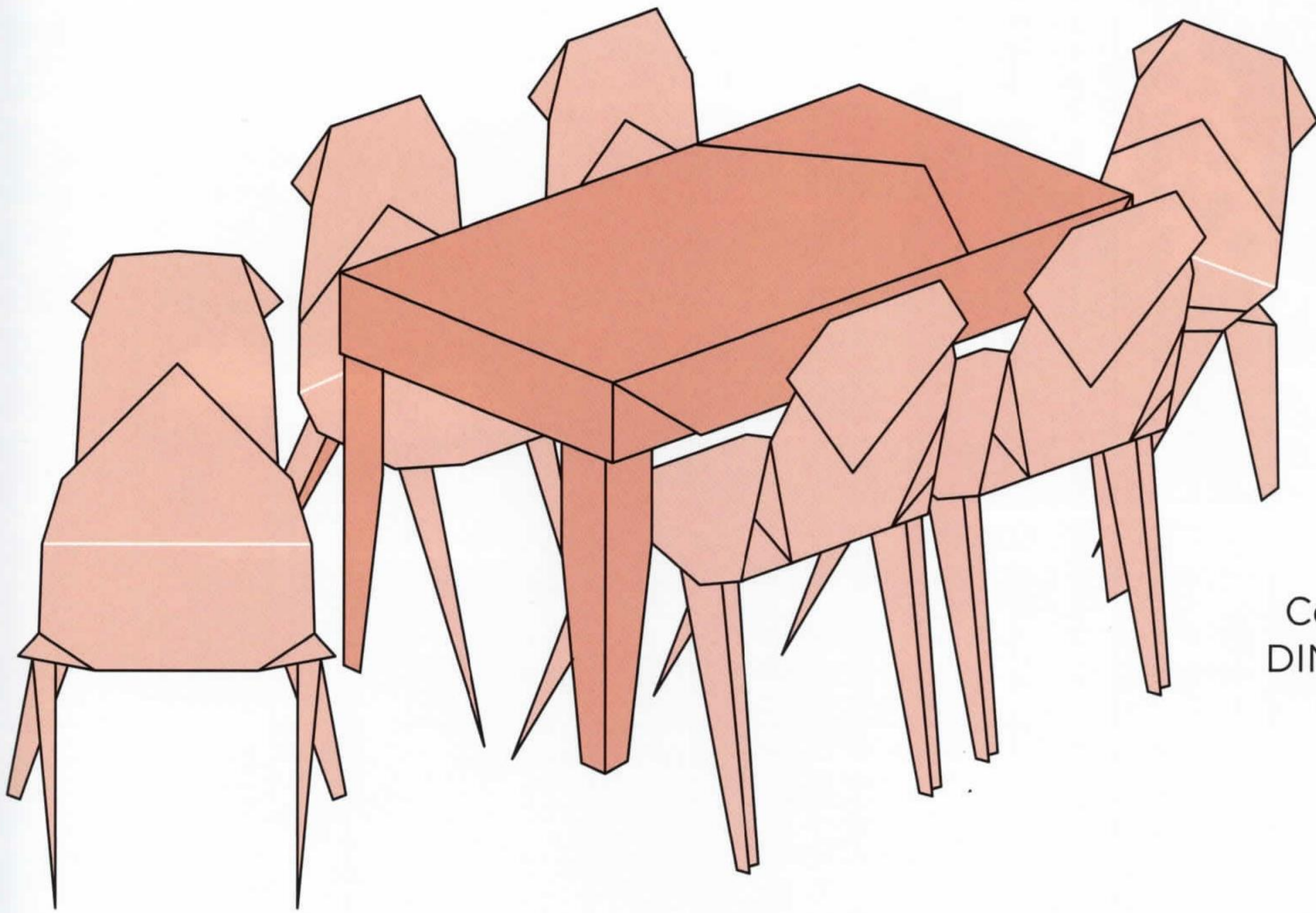

Completed
DINETTE SET



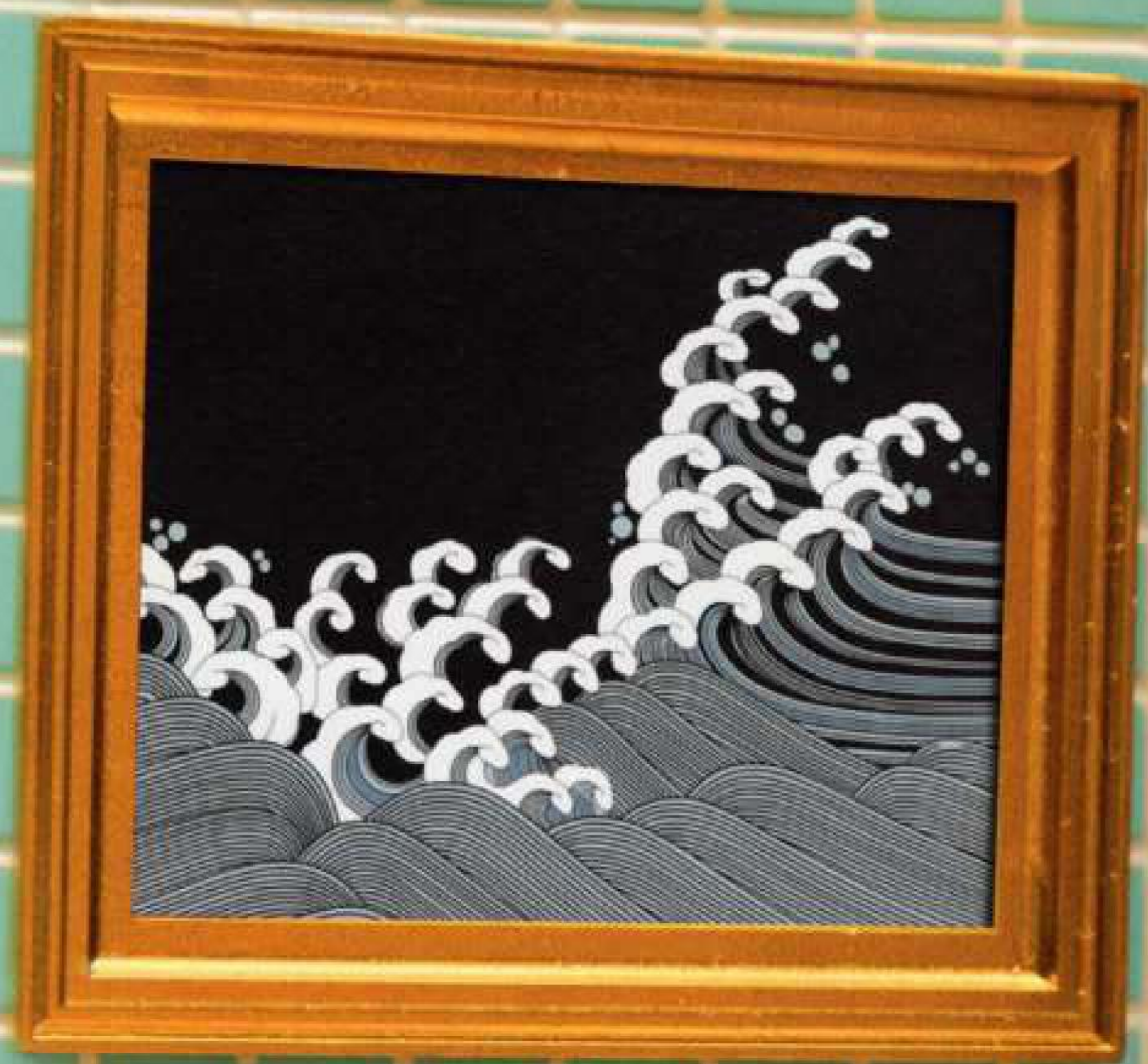

3

kitchen

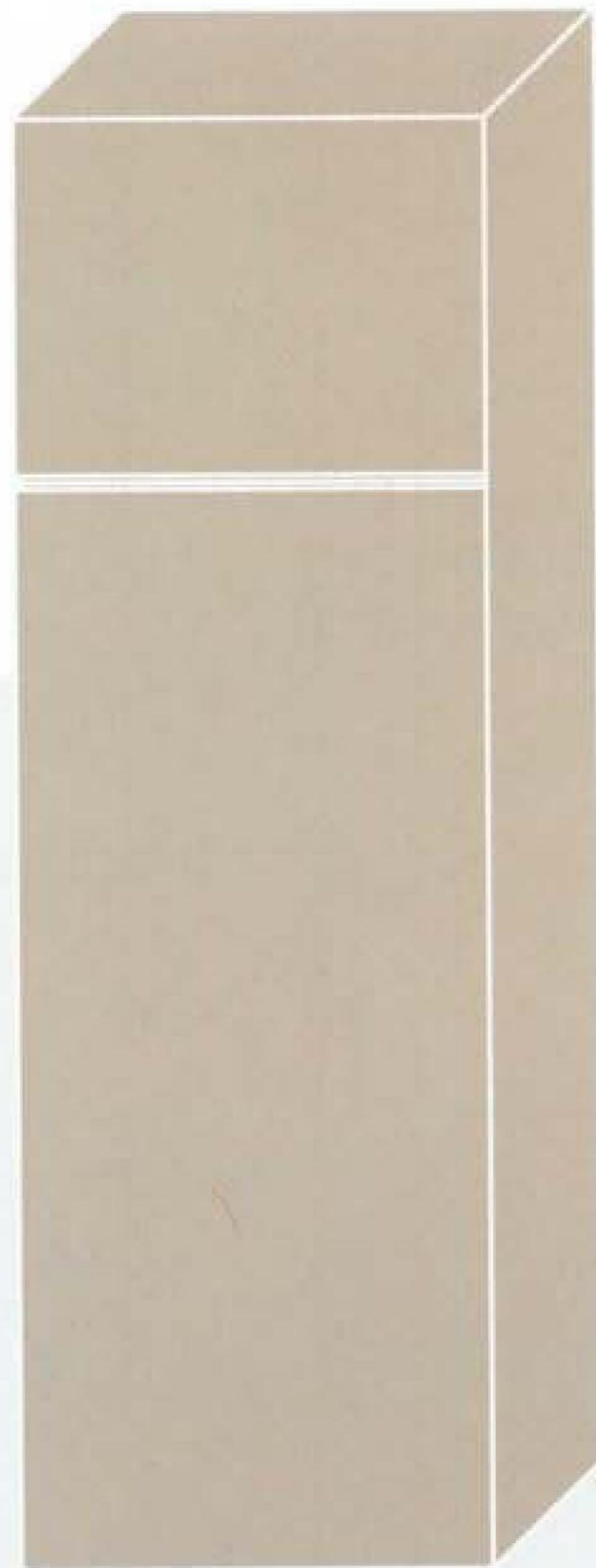
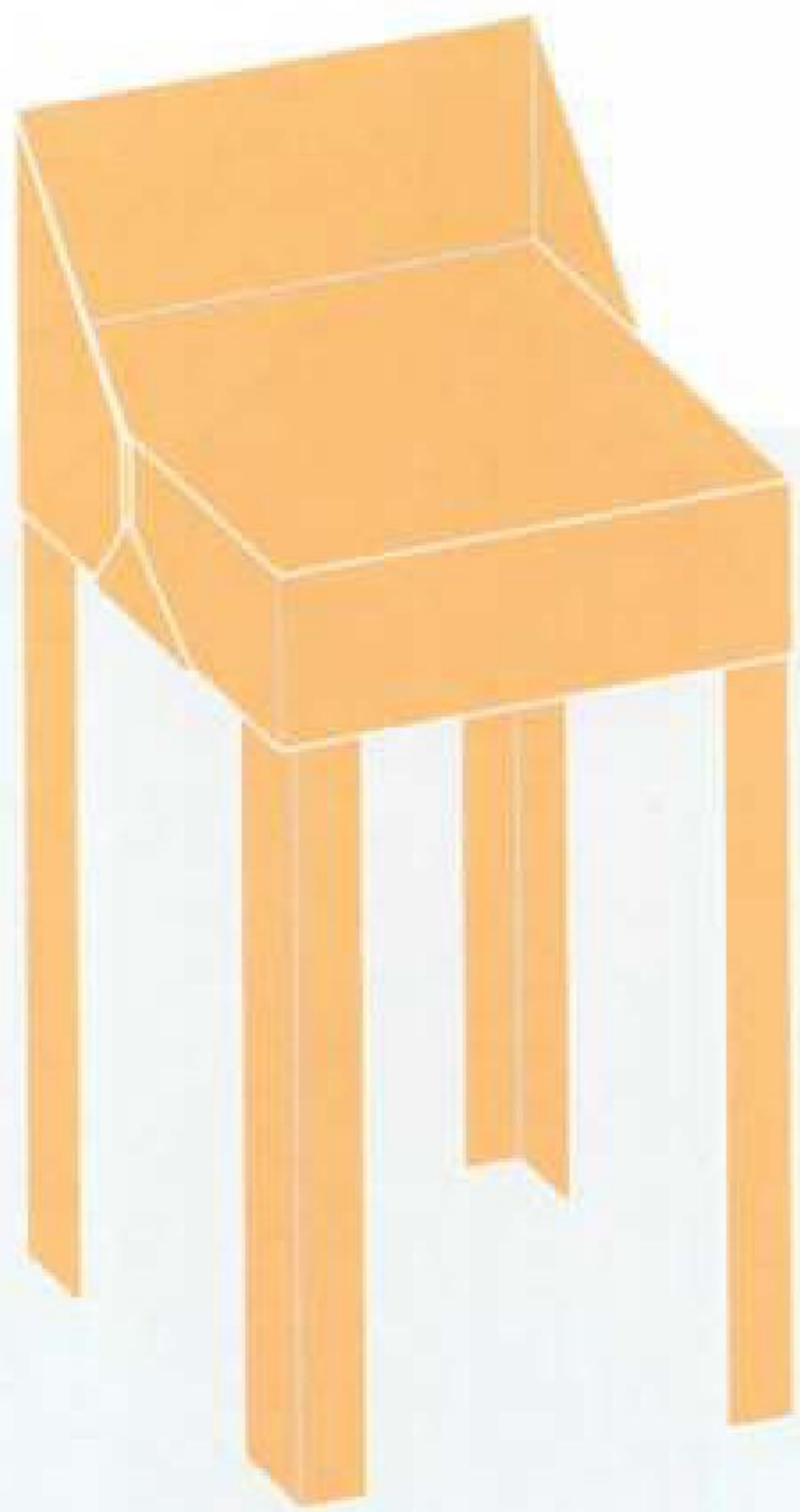

bar stool | refrigerator

▶ **bar stool**

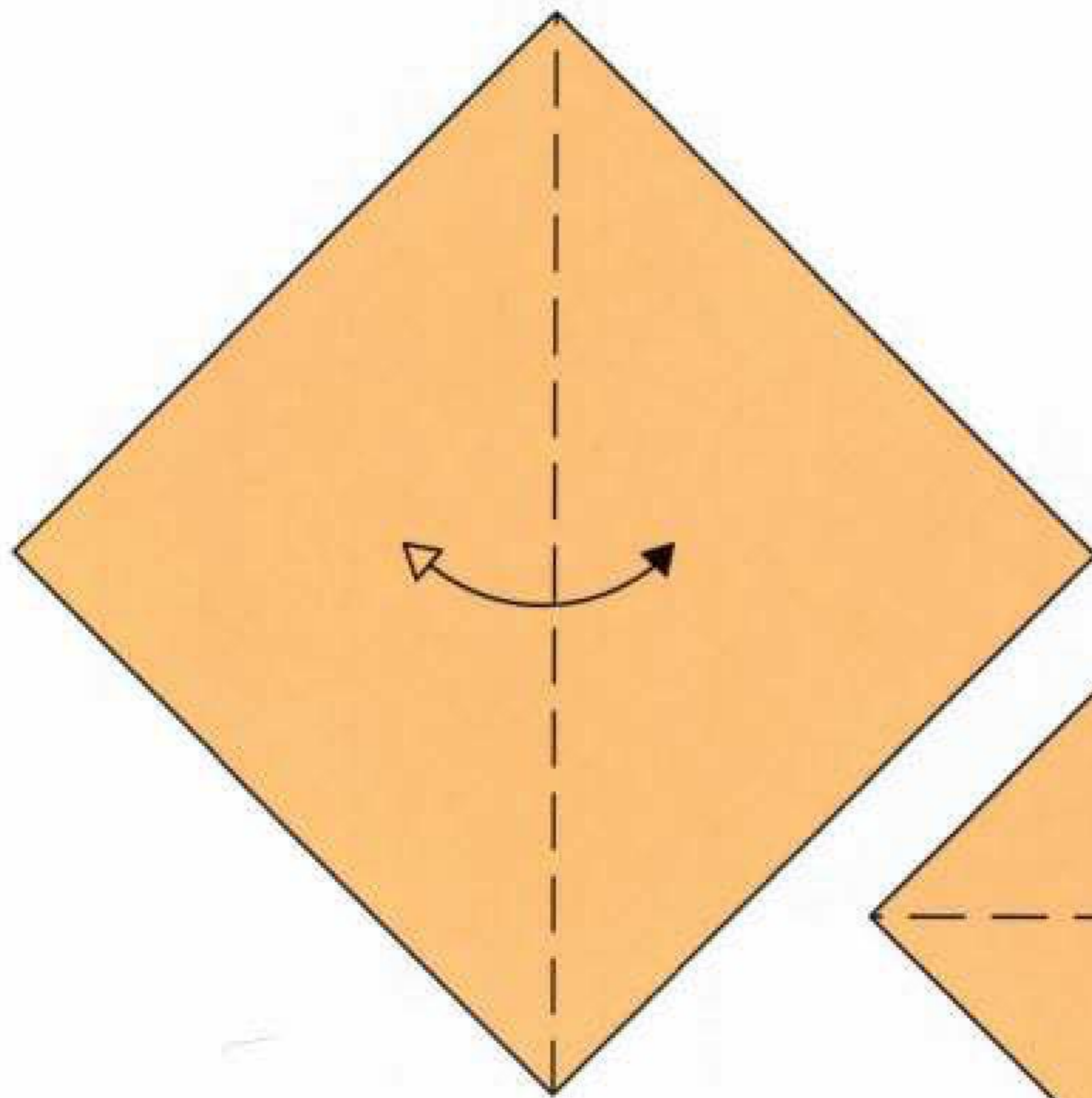

1. Valley fold and unfold

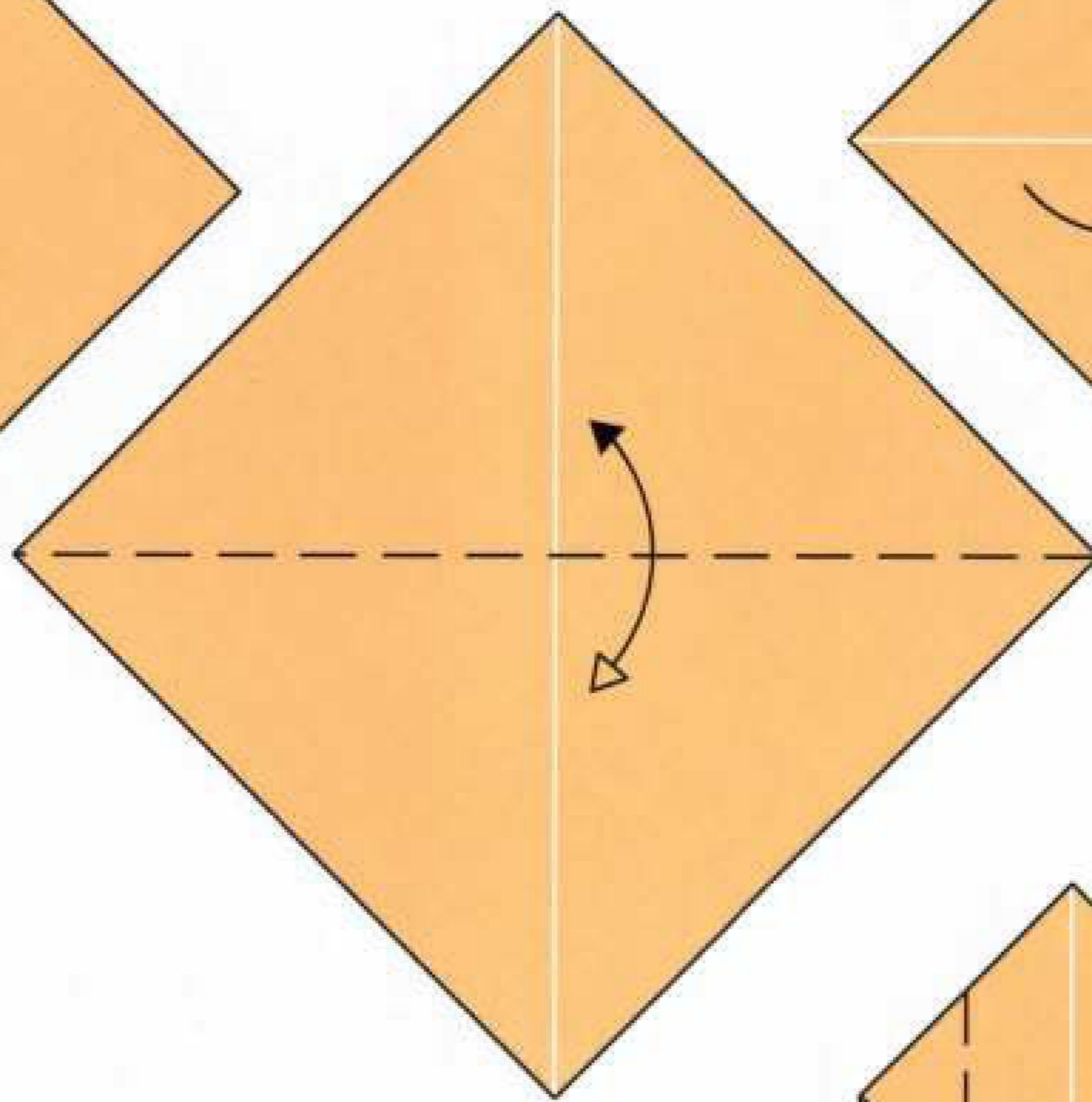

2. Valley fold and unfold

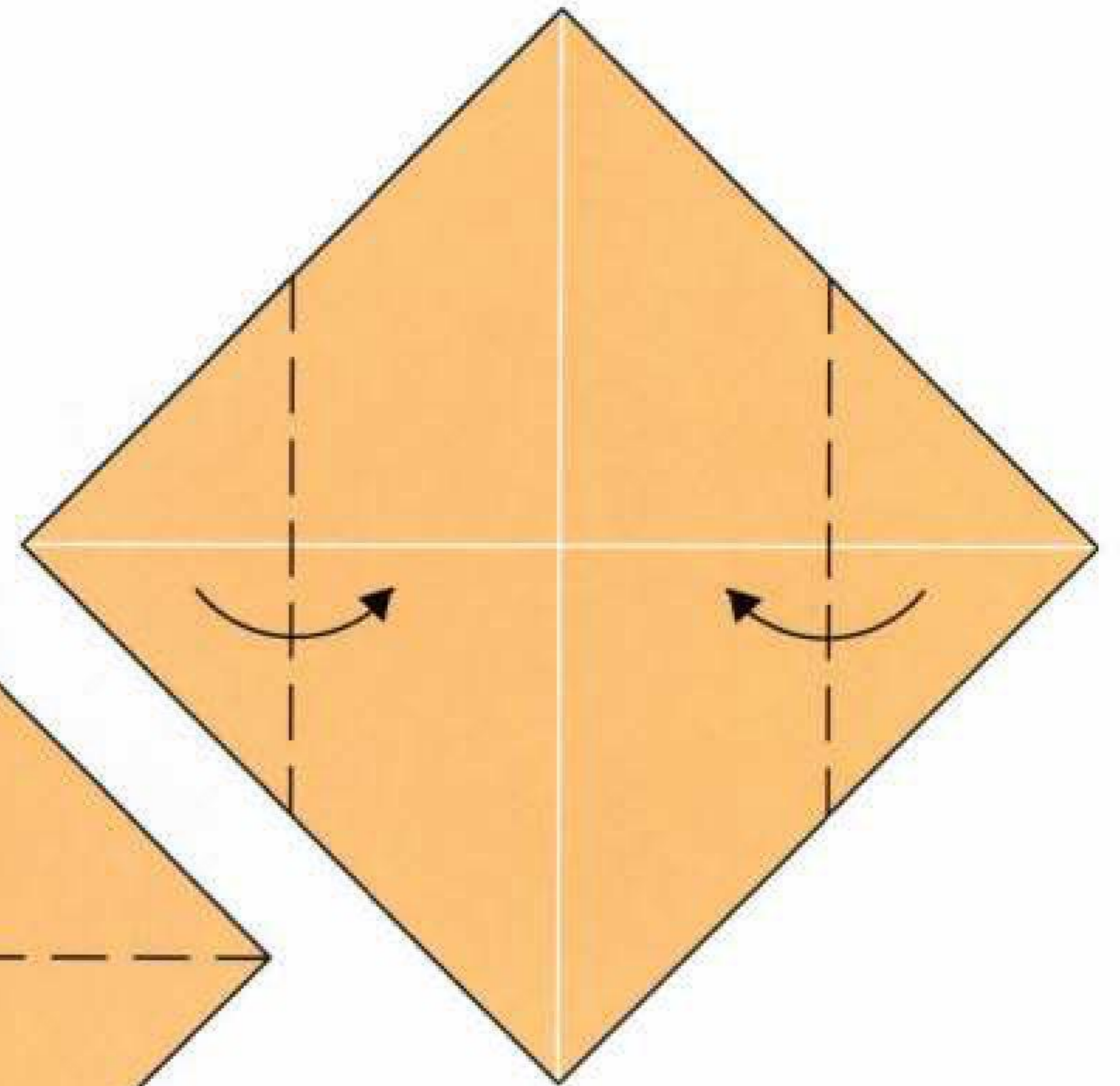

3. Valley folds

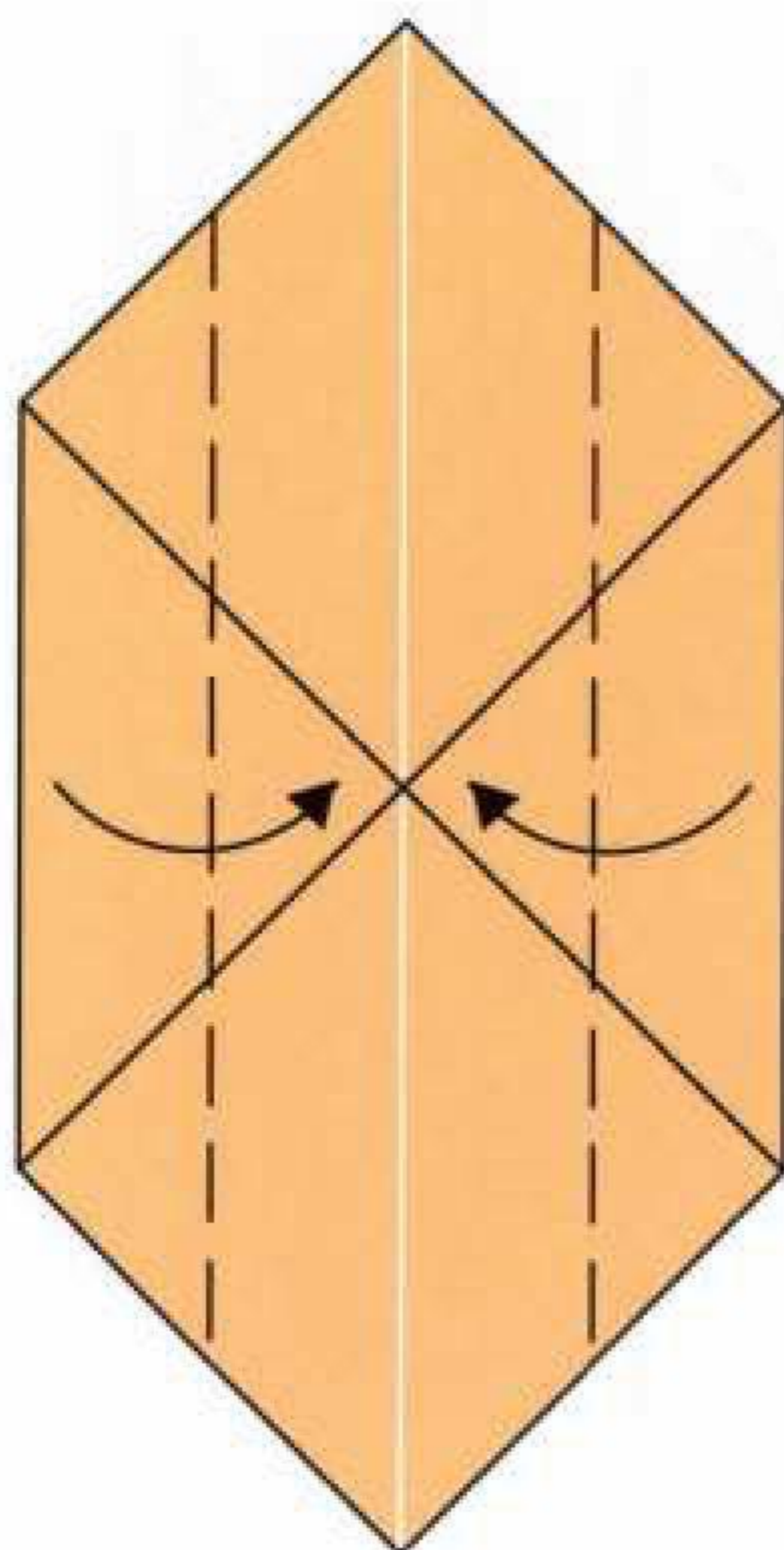

4. Valley folds

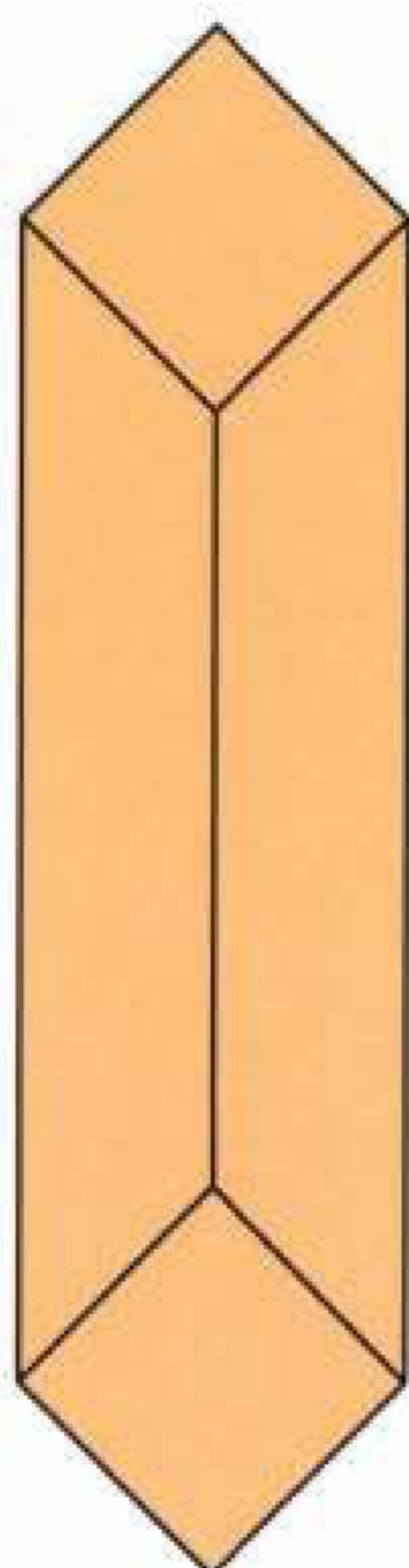

5. Scale-up

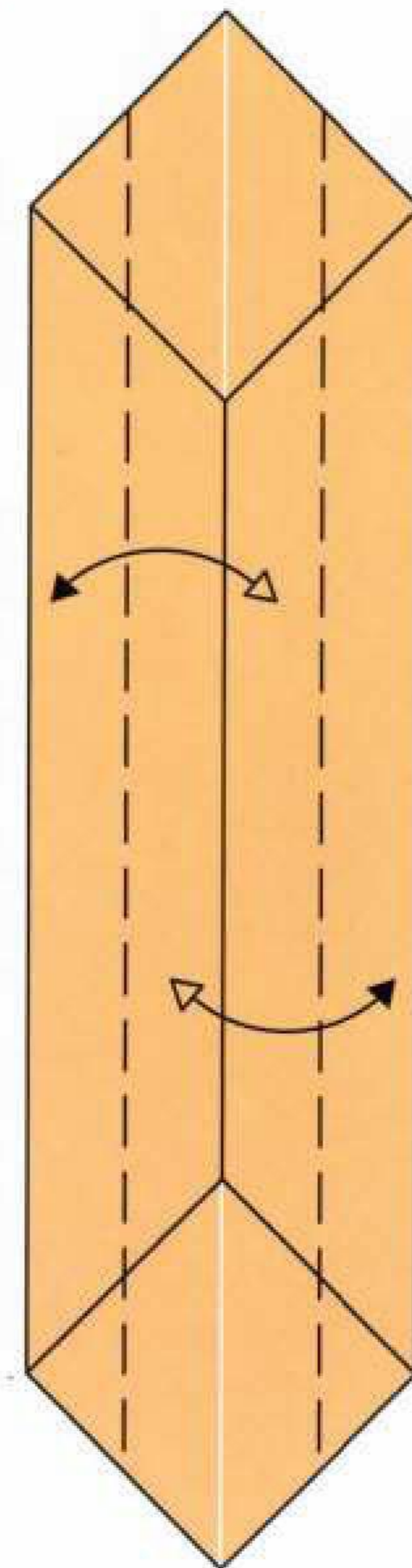

6. Fold and unfold

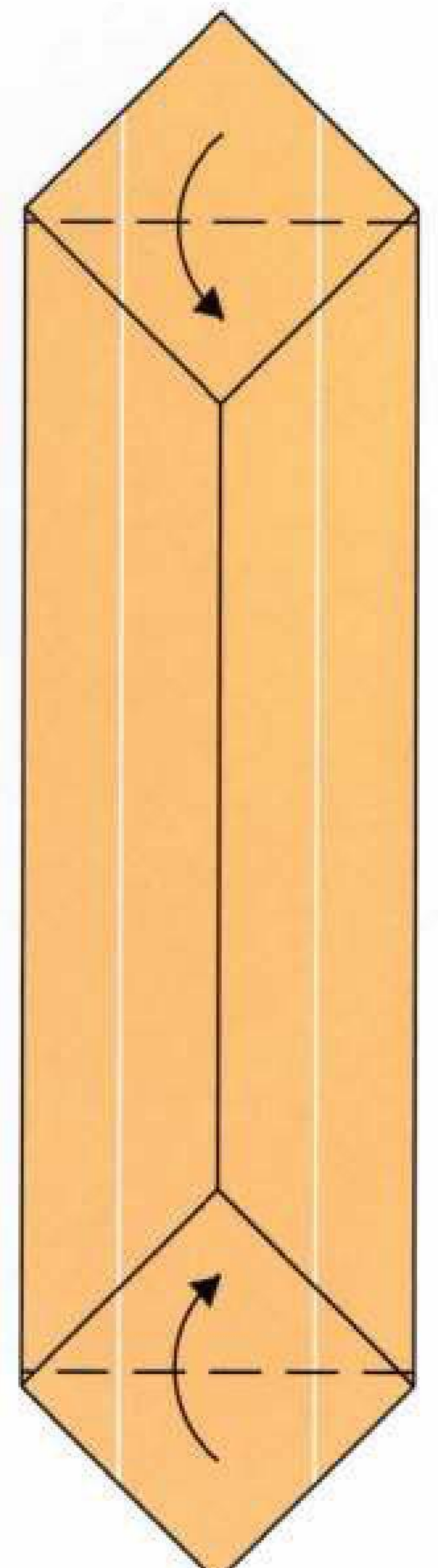

7. Valley folds

bar stool

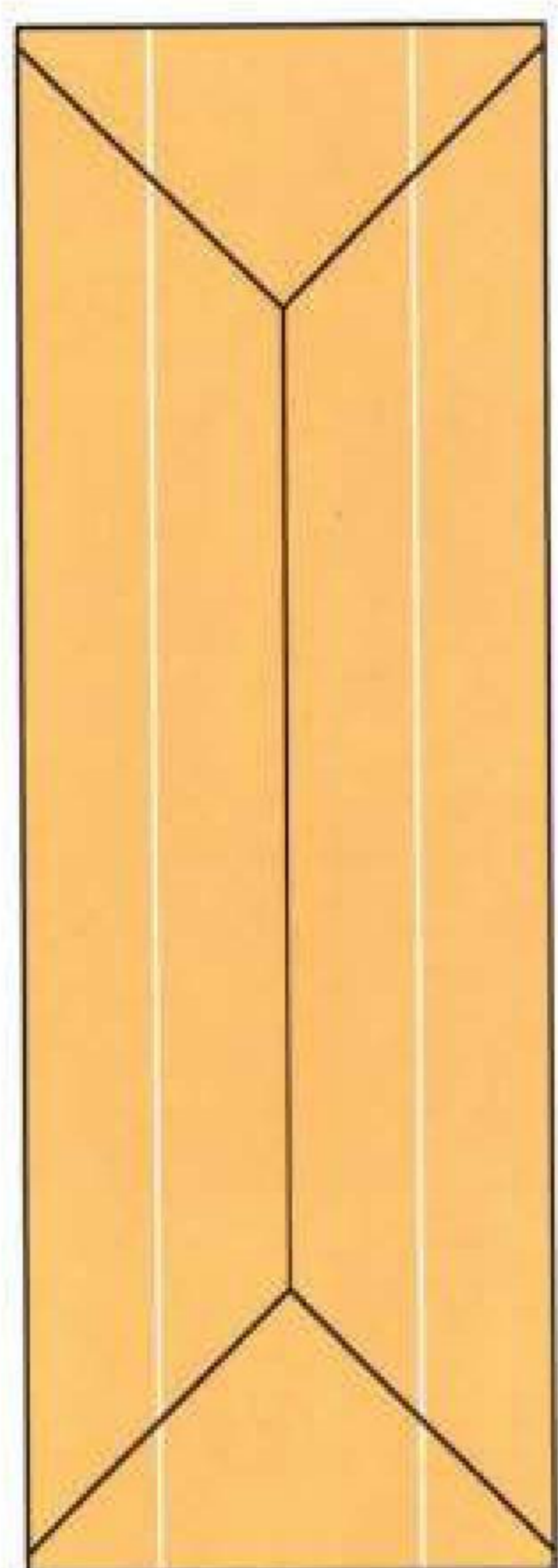

8. Turn over

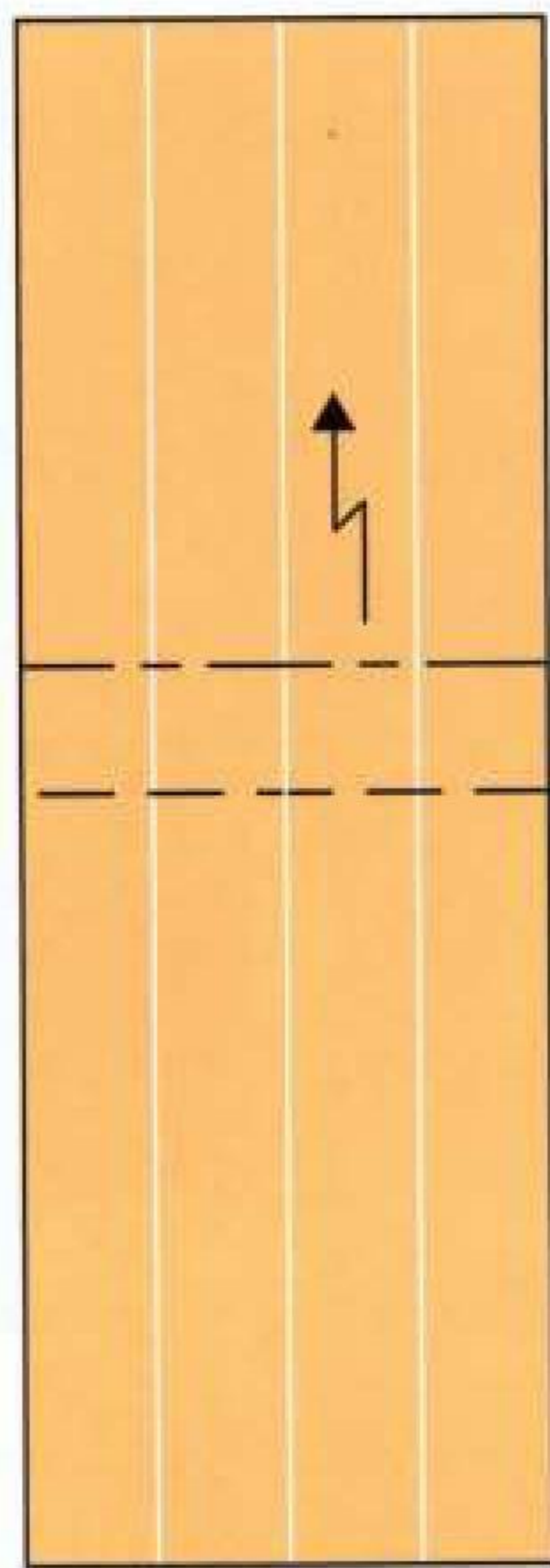

9. Pleat fold

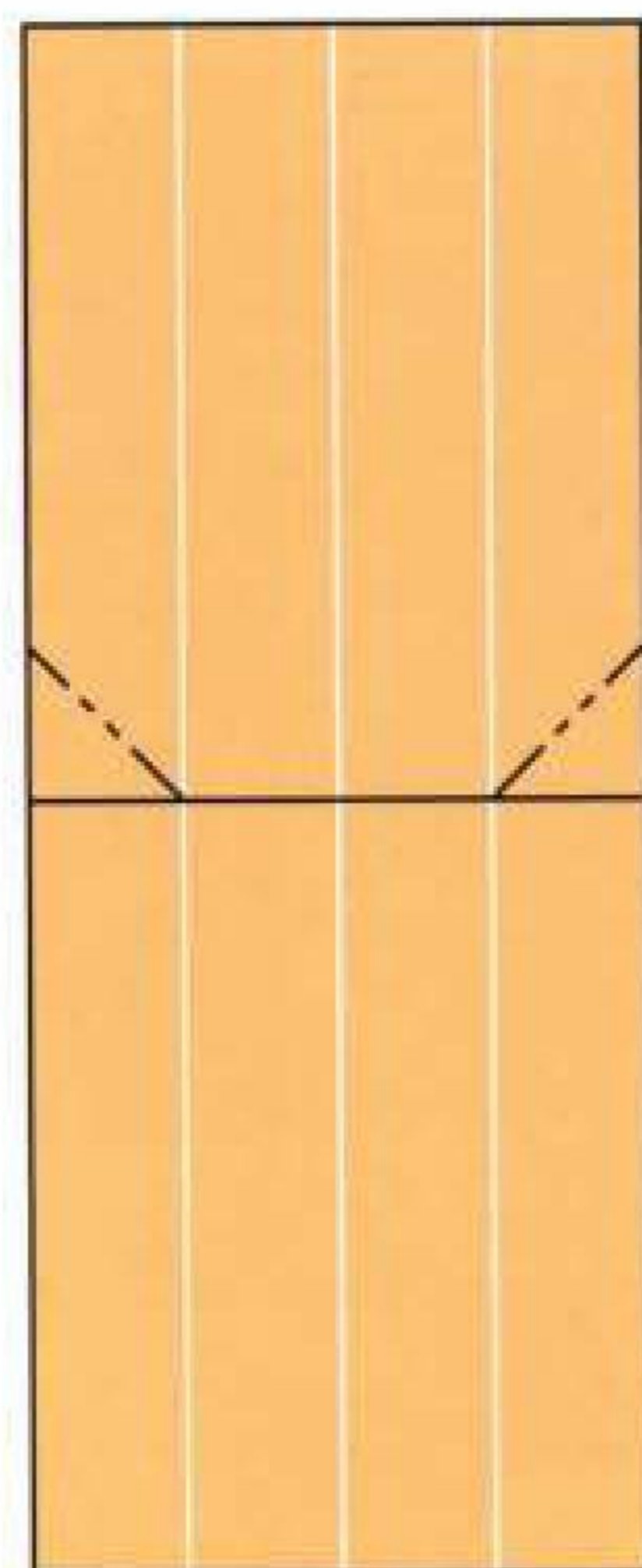

10. Inside reverse folds

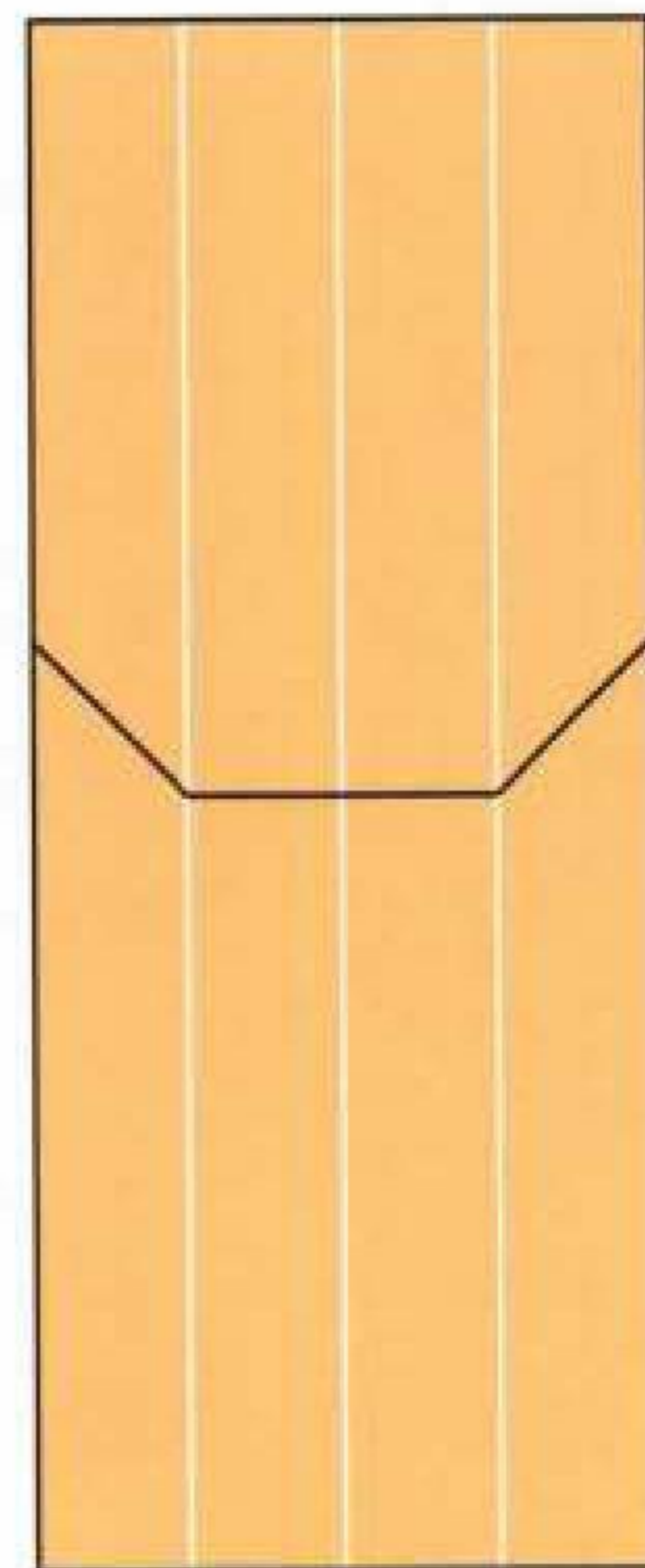

11. Turn over

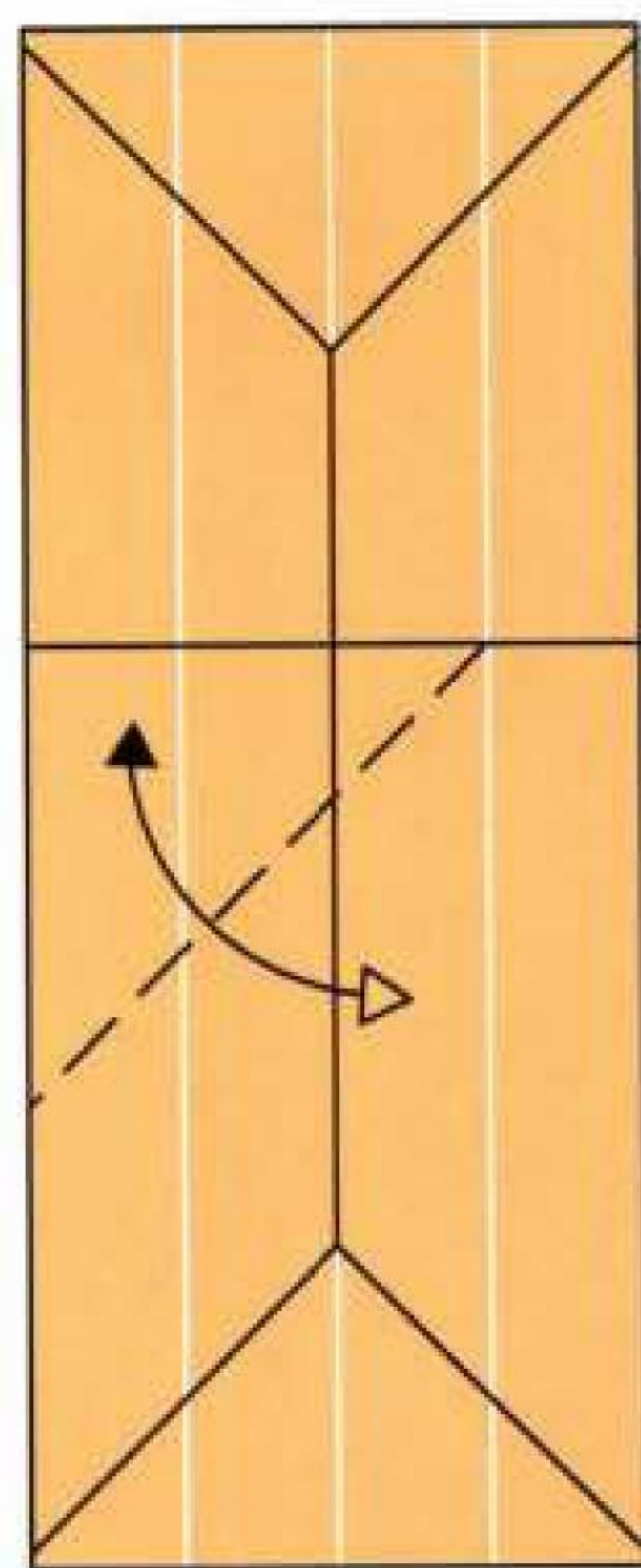

12. Valley fold and unfold

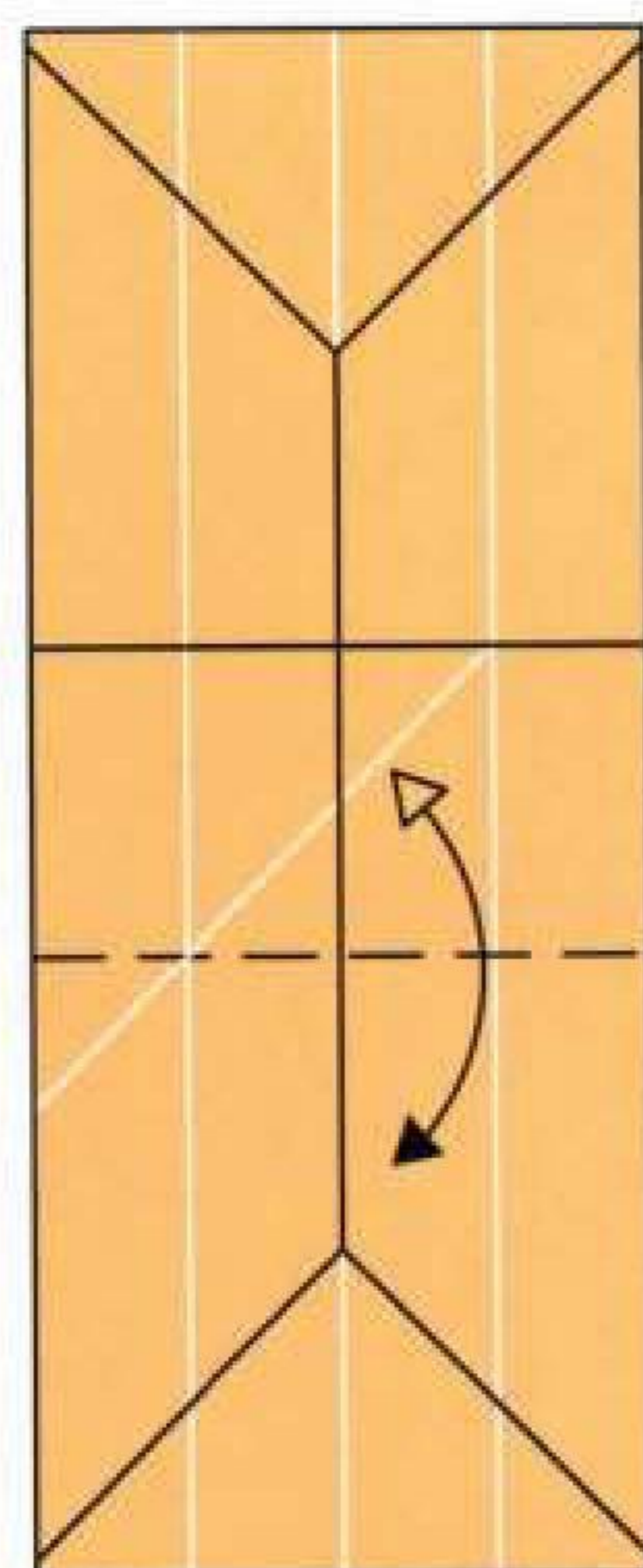

13. Repeat

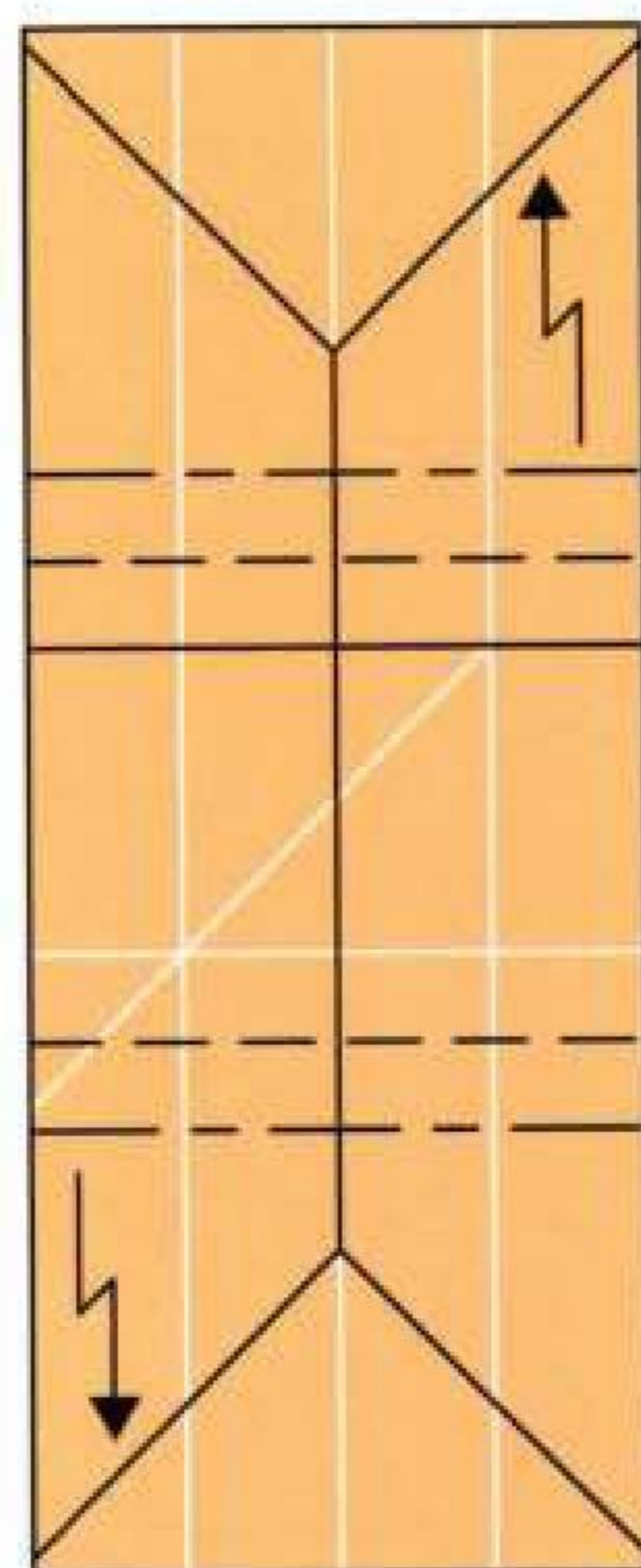

14. Pleat folds

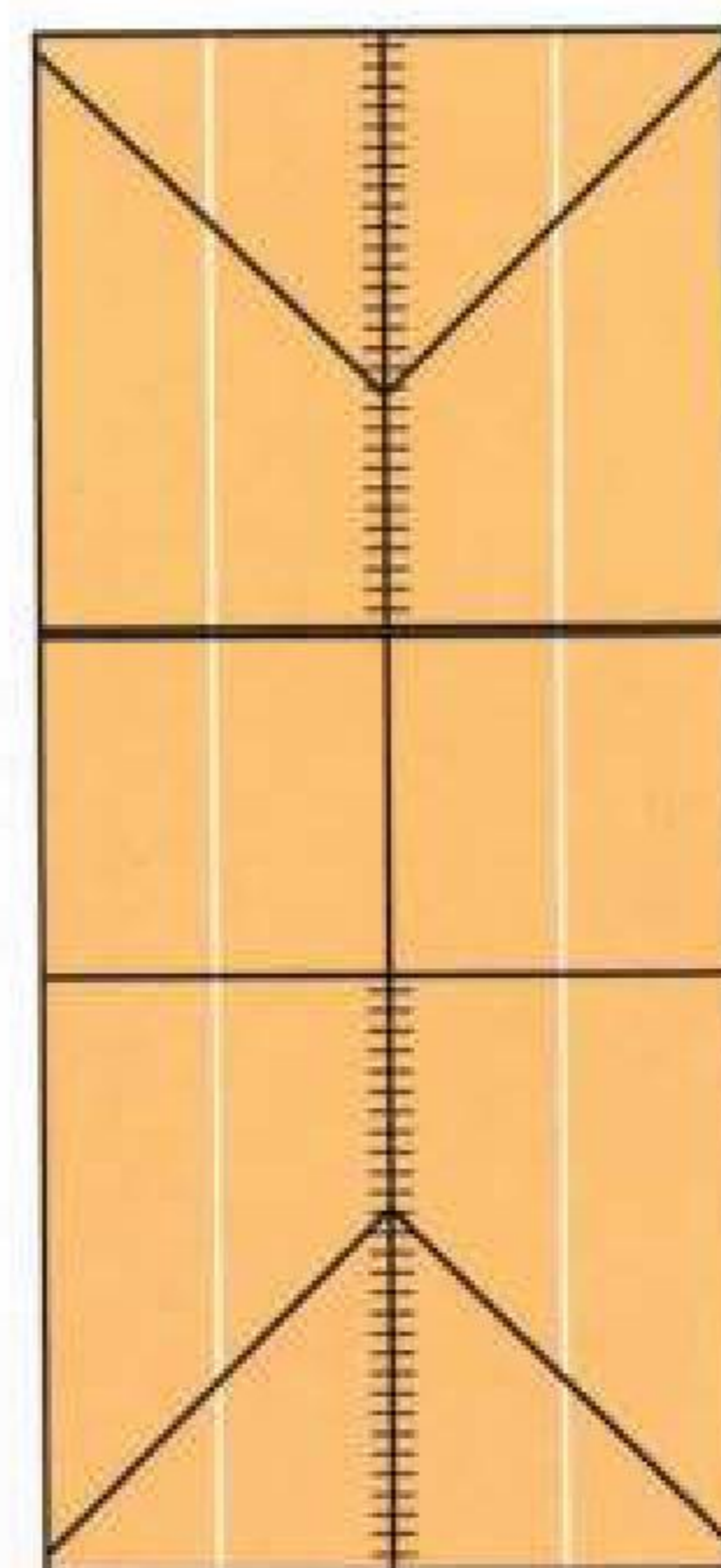

15. Cuts as shown

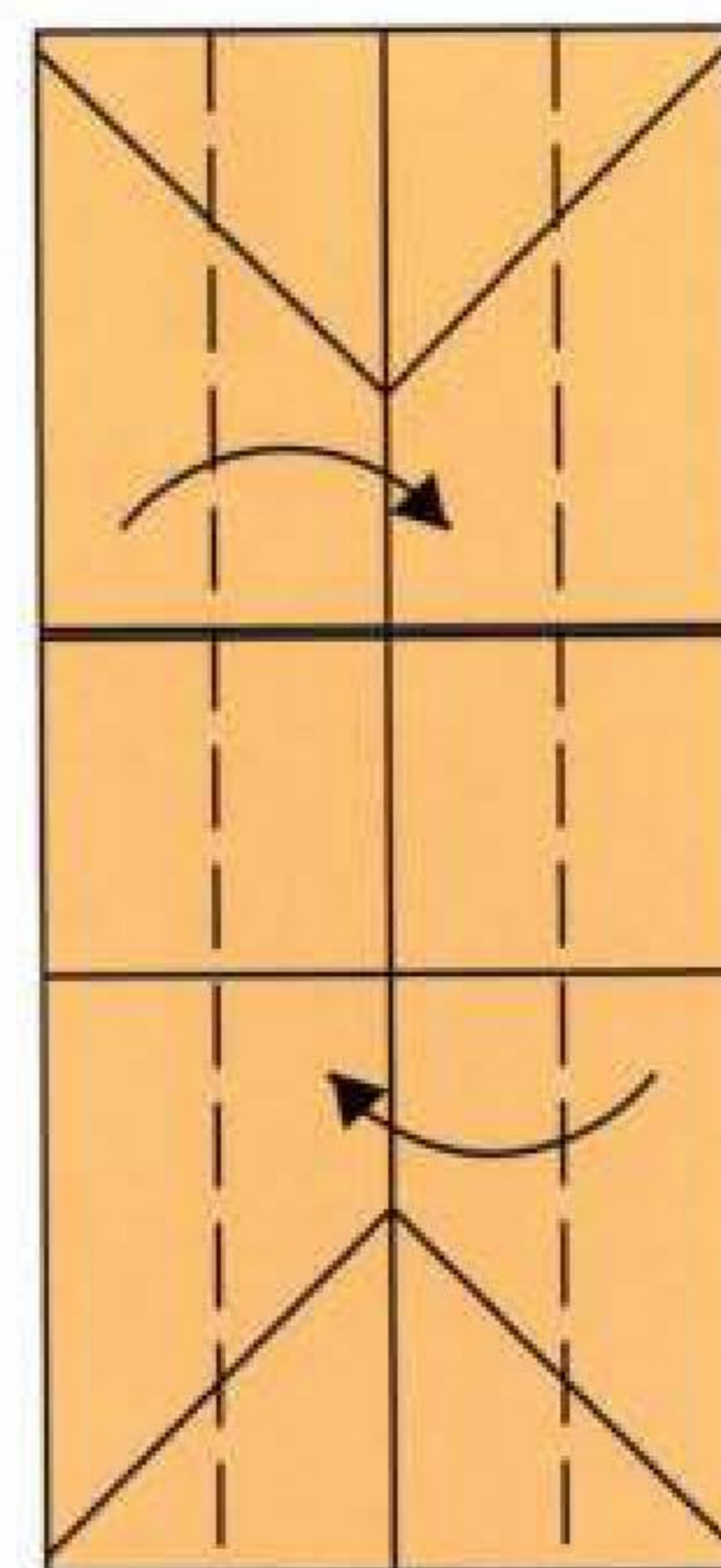

16. Valley folds

bar stool

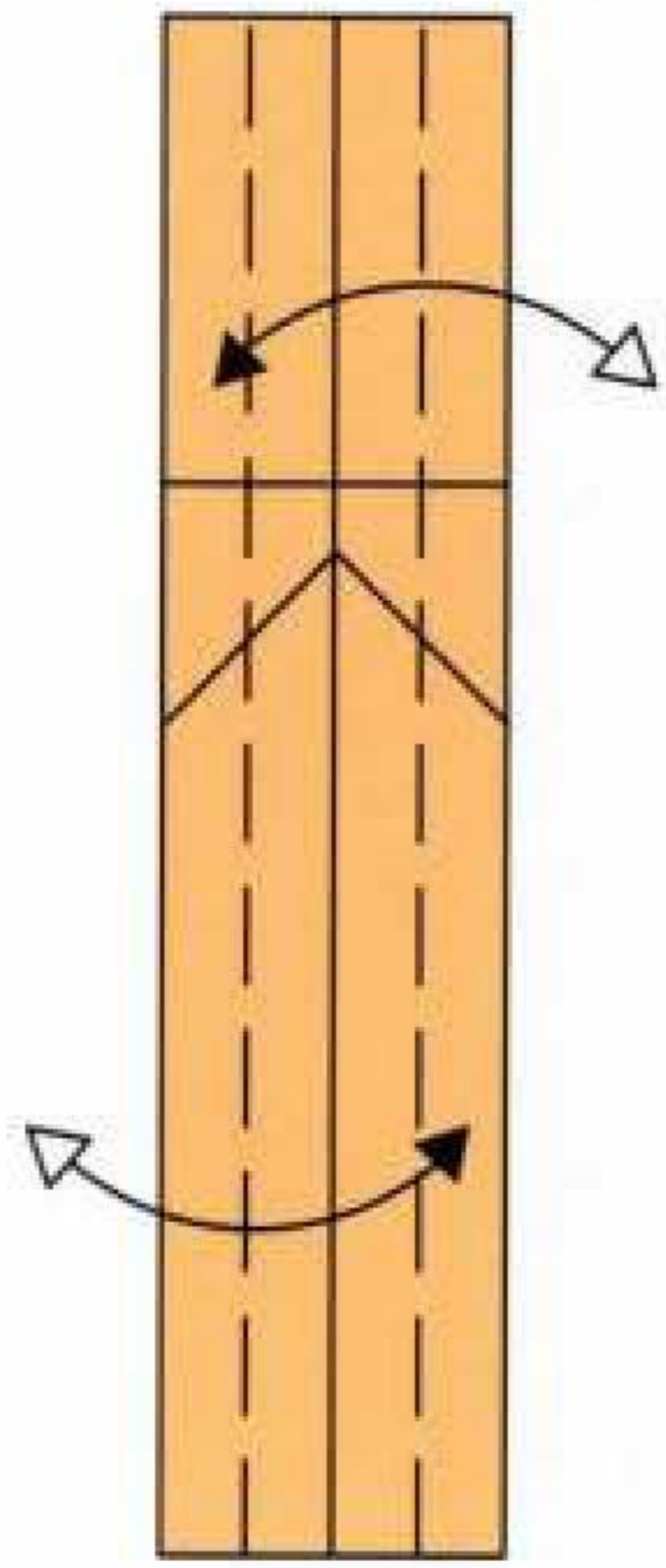

17. Valley folds and unfold

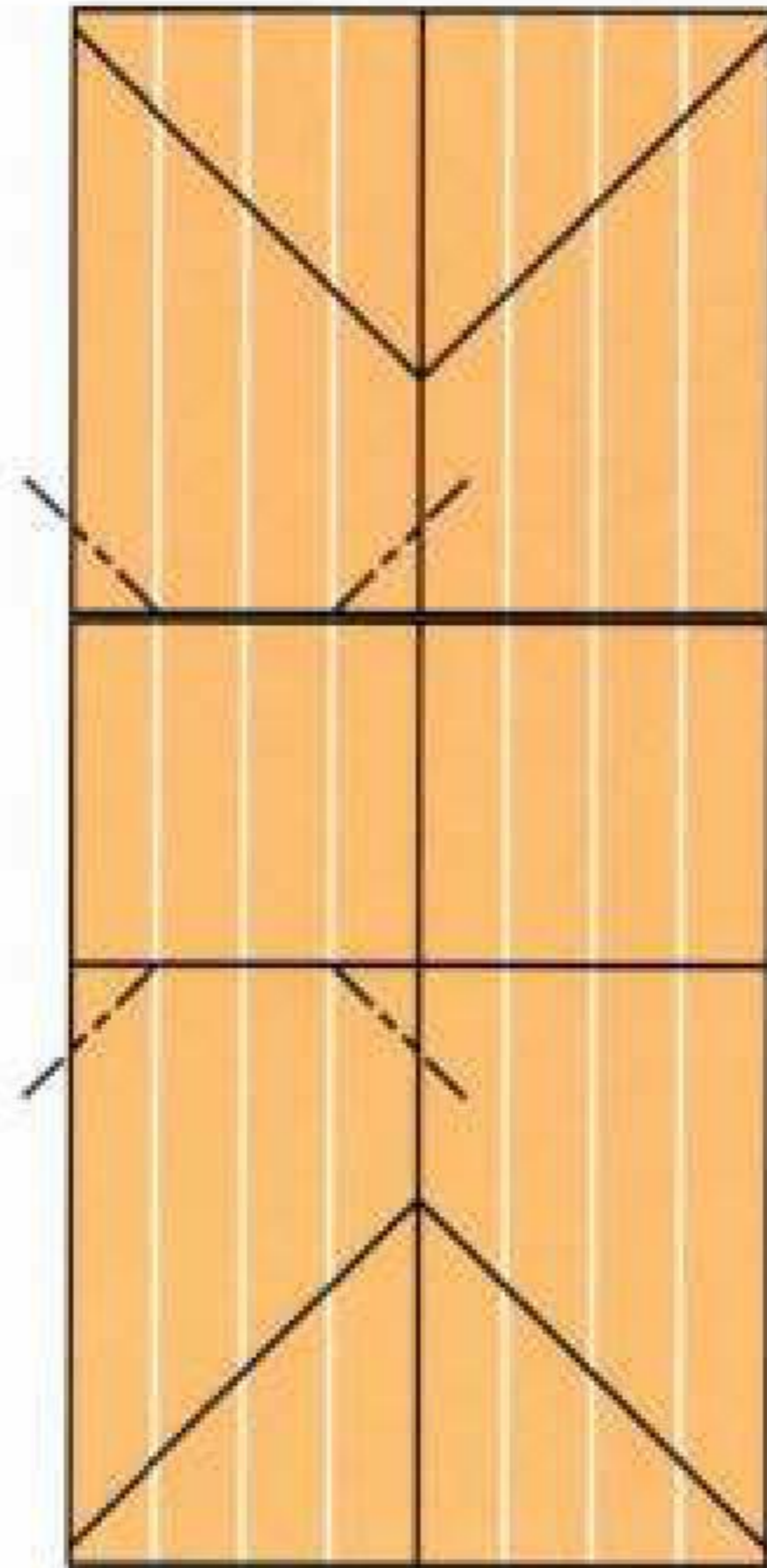

18. Inside reverse folds

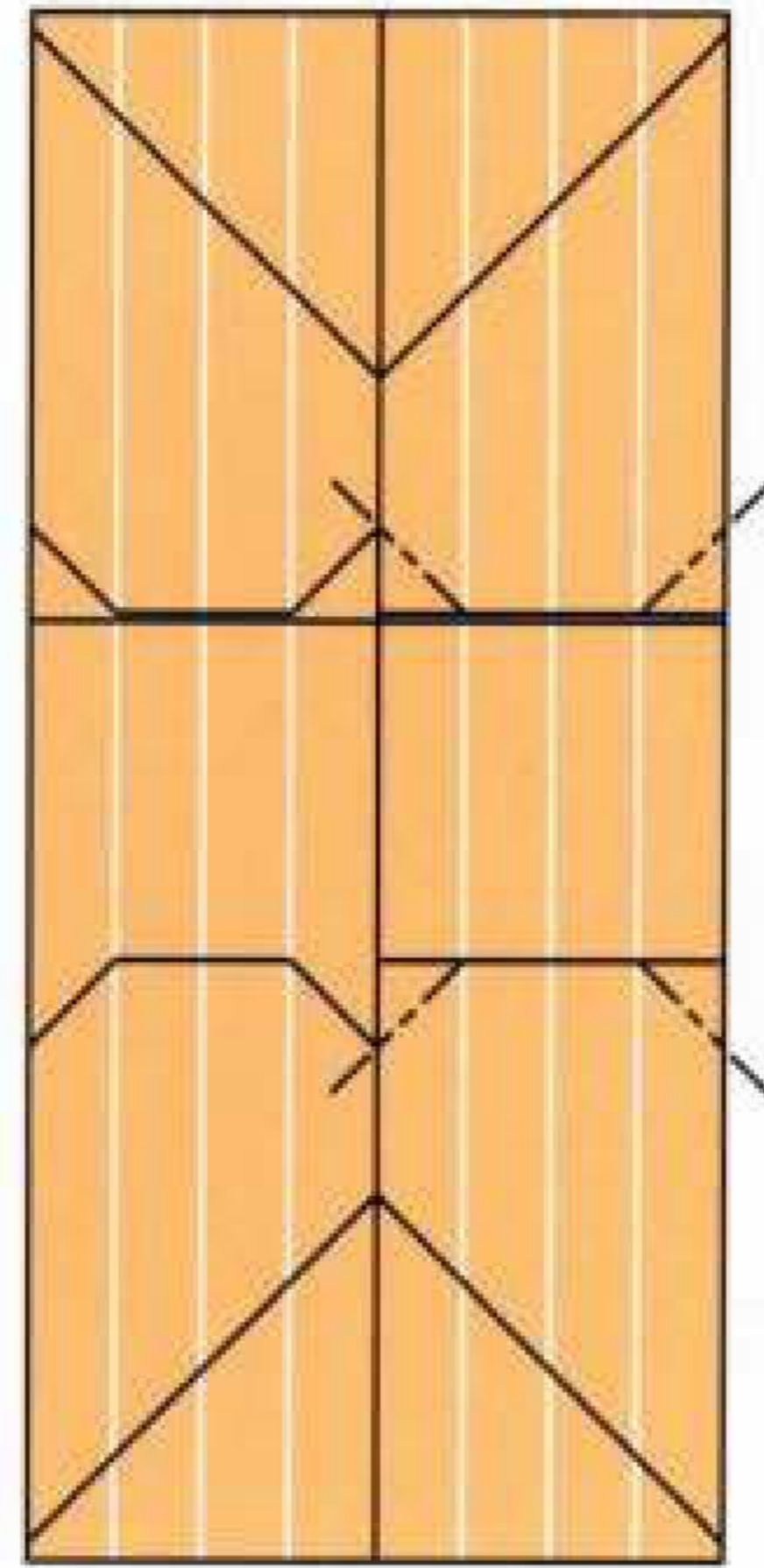

19. Repeat

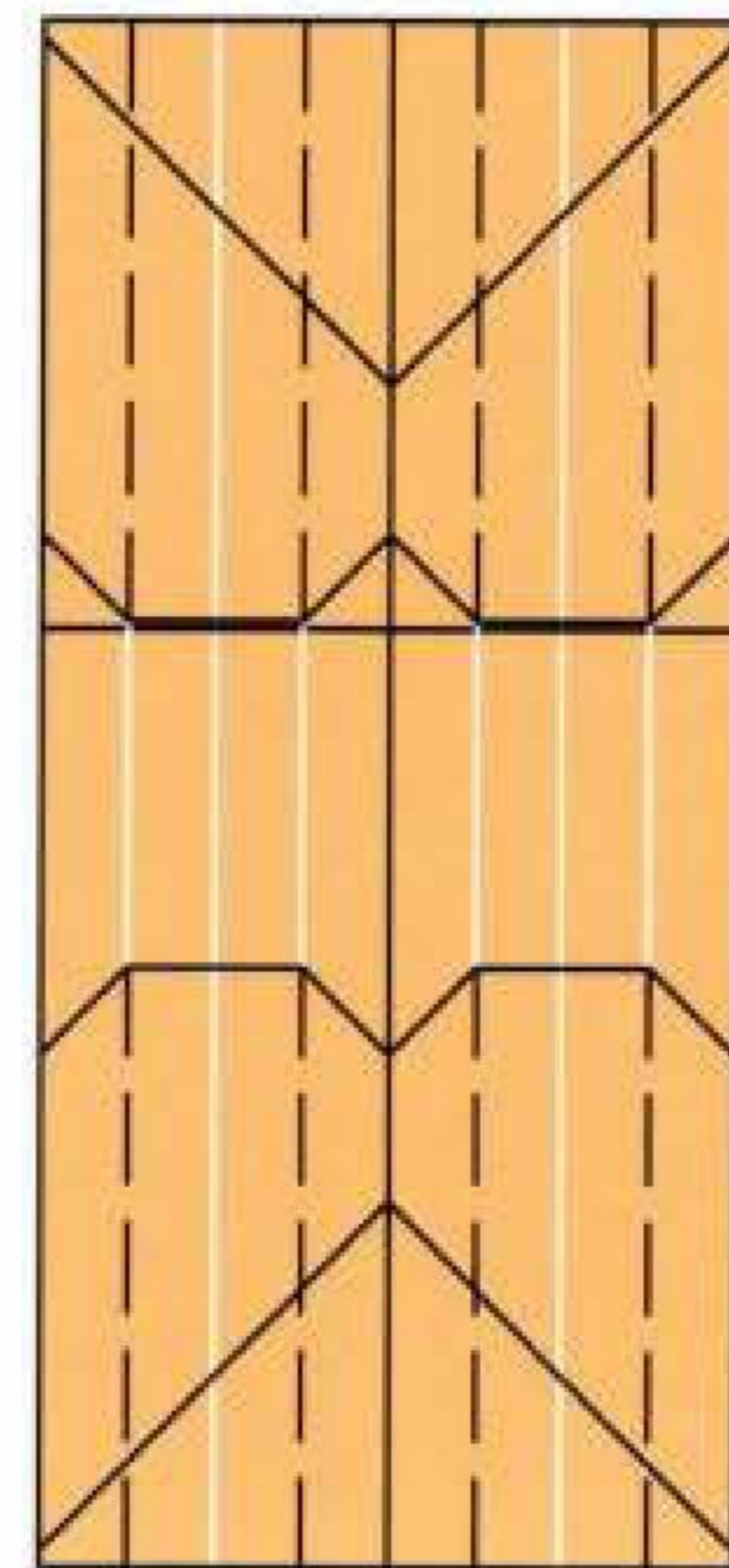

20. Valley folds

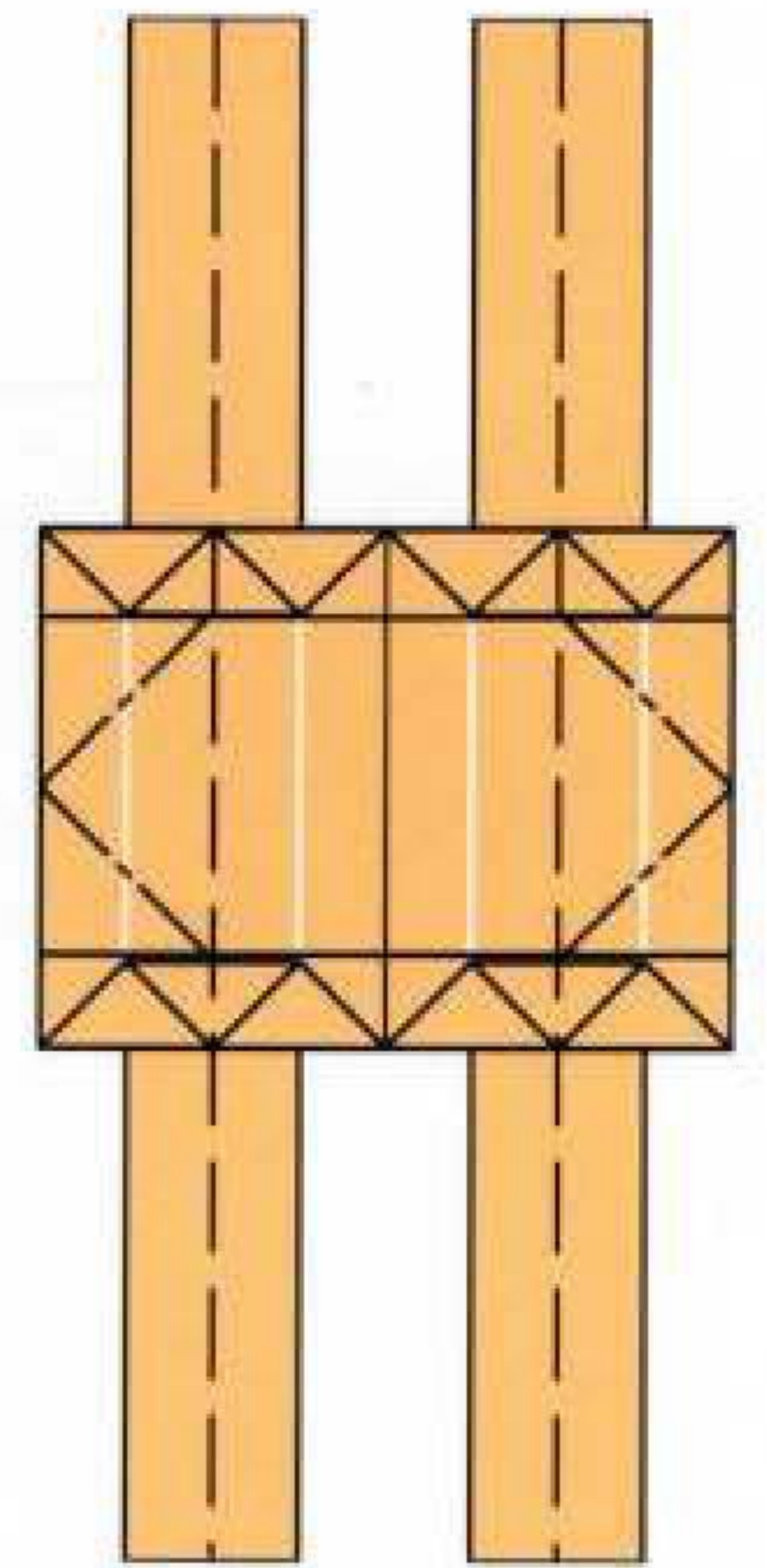

21. Valley folds and Squash folds at the same time

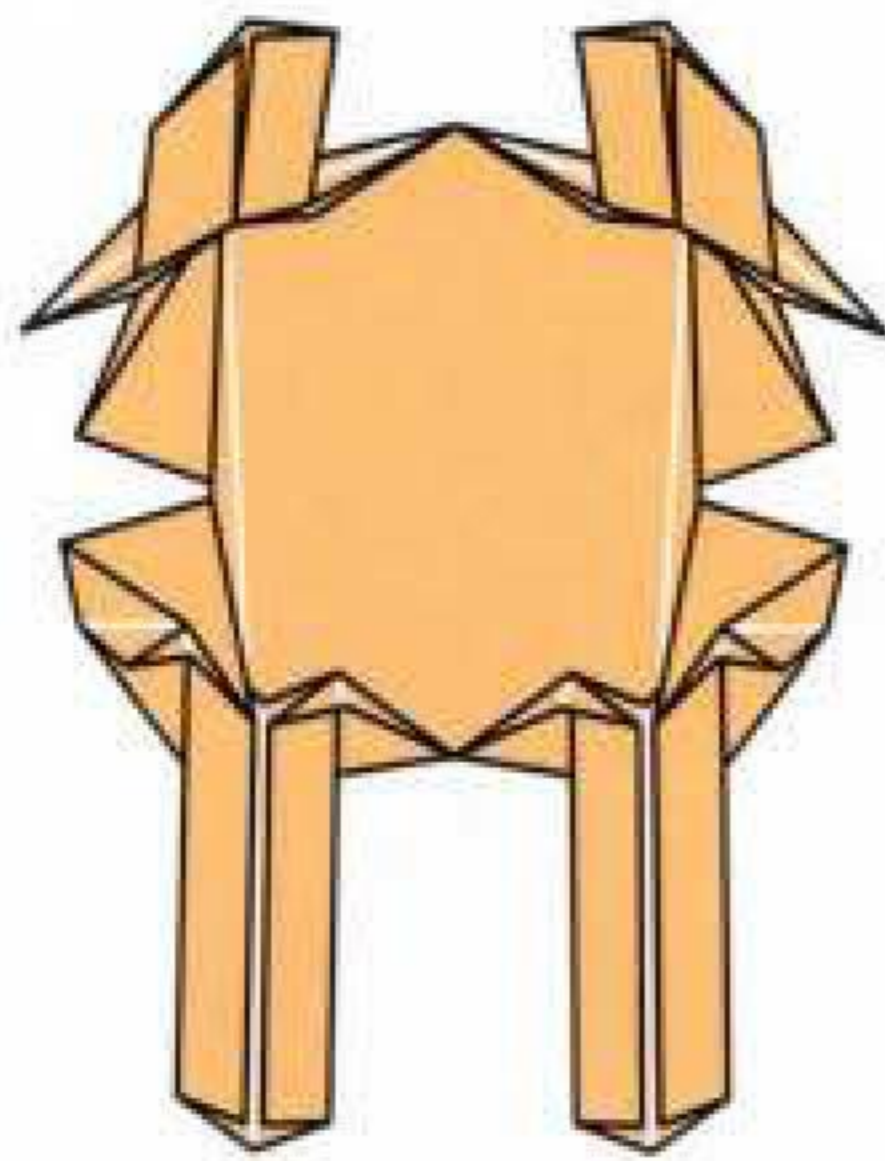

22. Almost complete

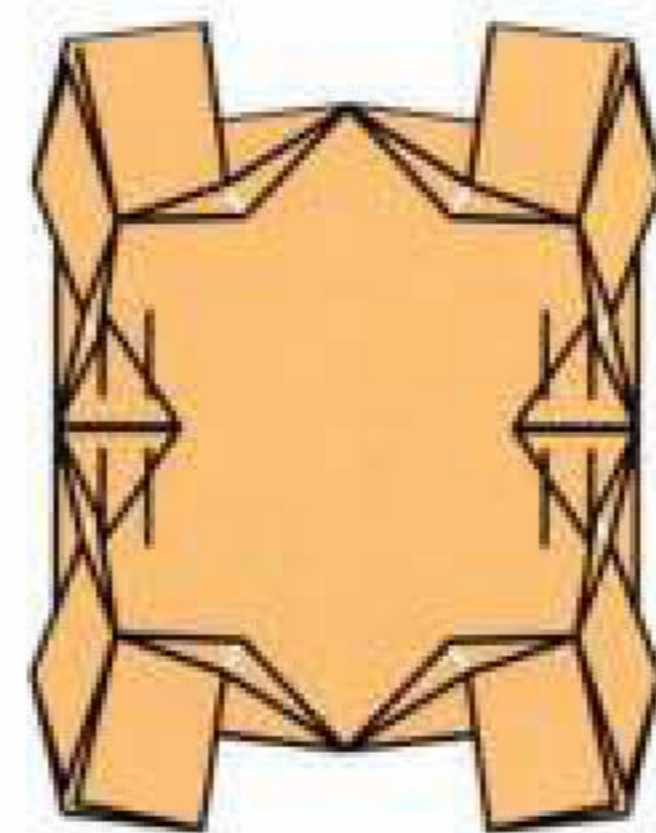

23. Valley folds to wrap around layers

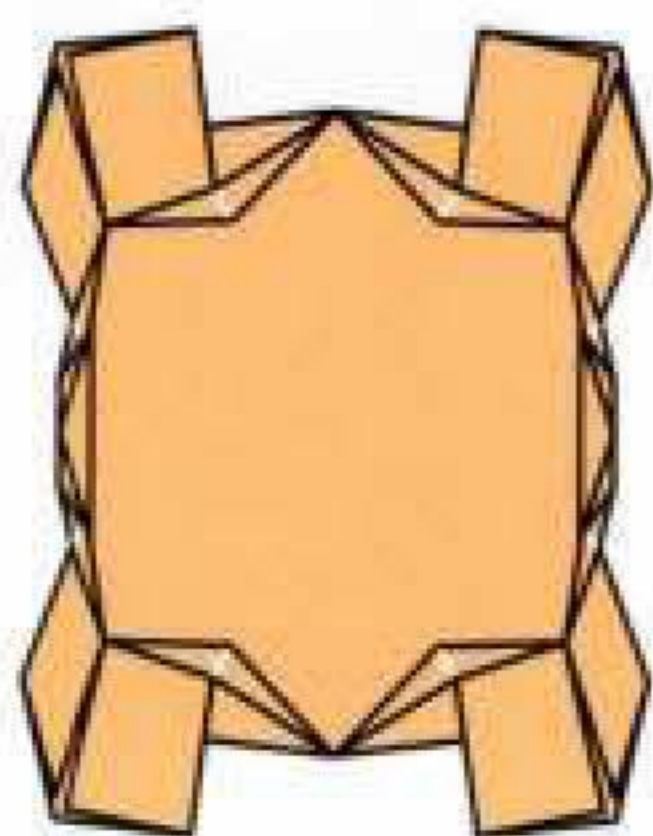

24. Rotate

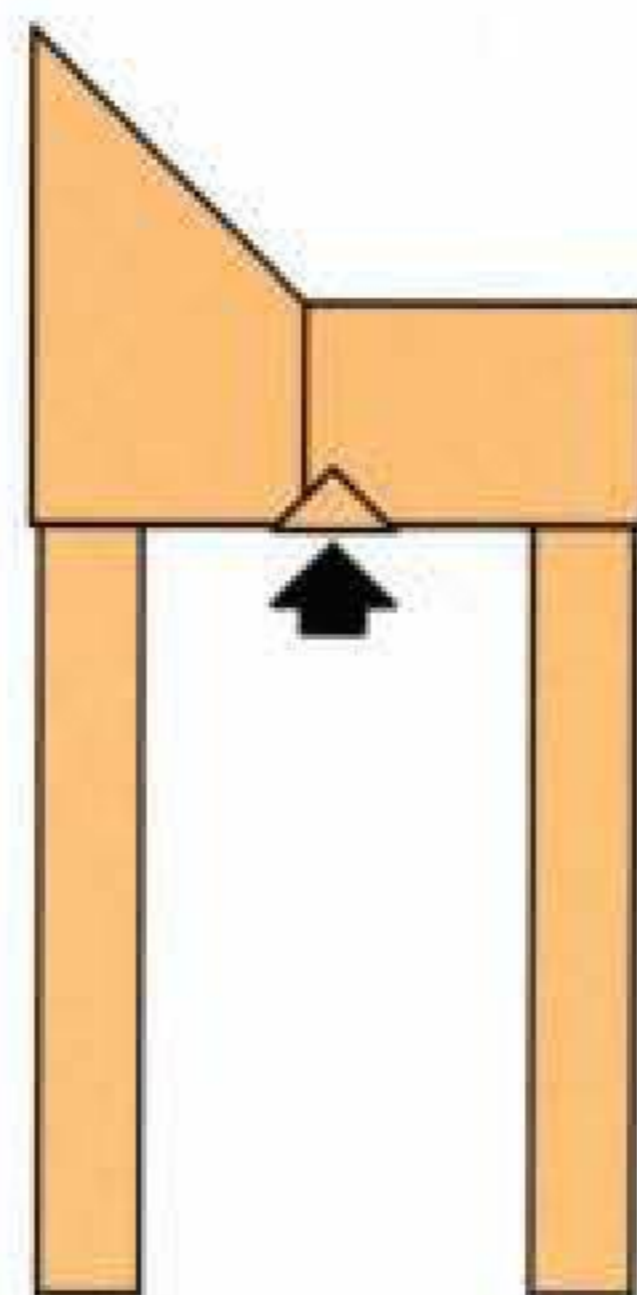

25. Apply glue to both sides and rotate

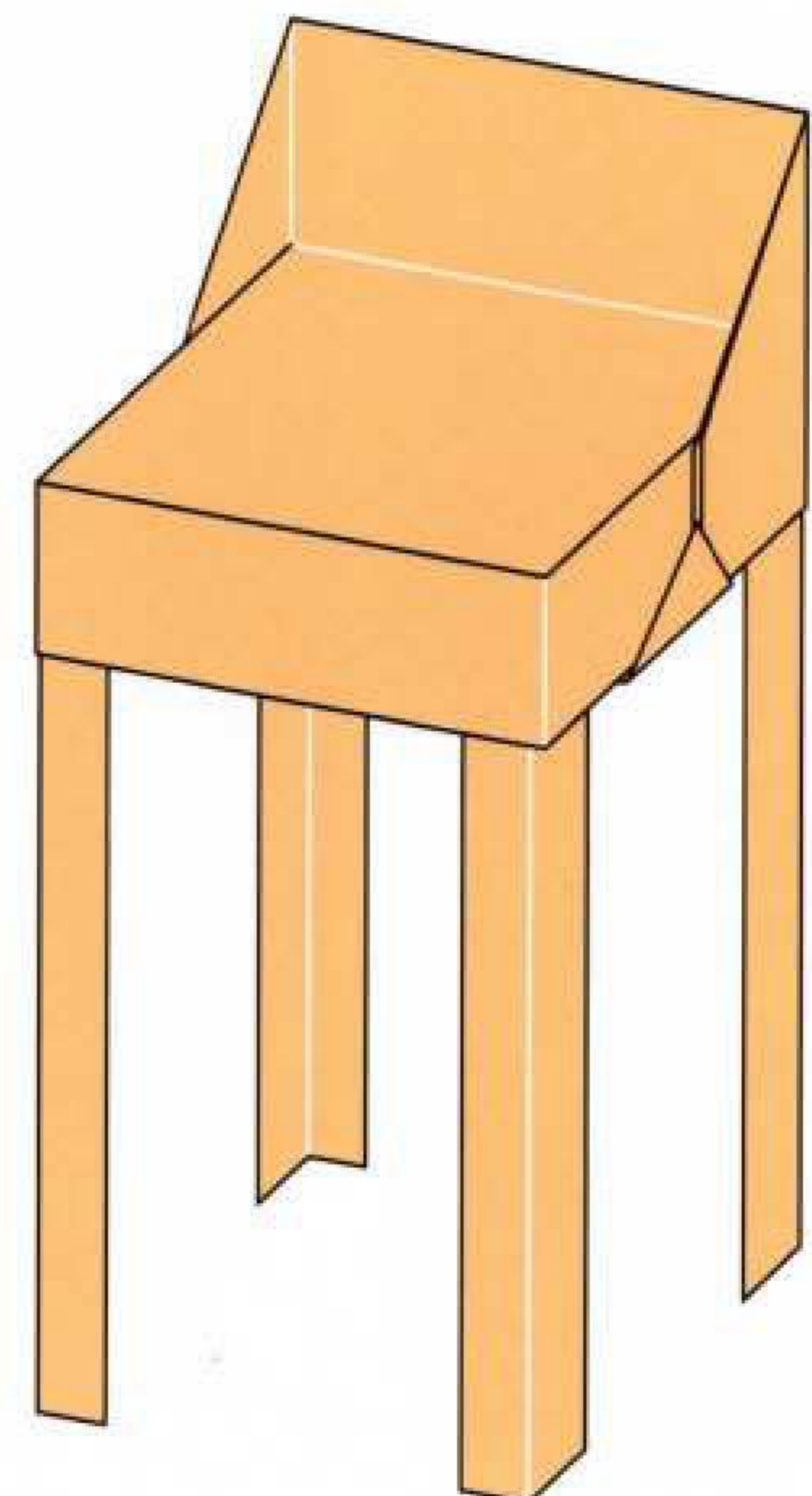

26. Completed BAR STOOL

► refrigerator: part 1

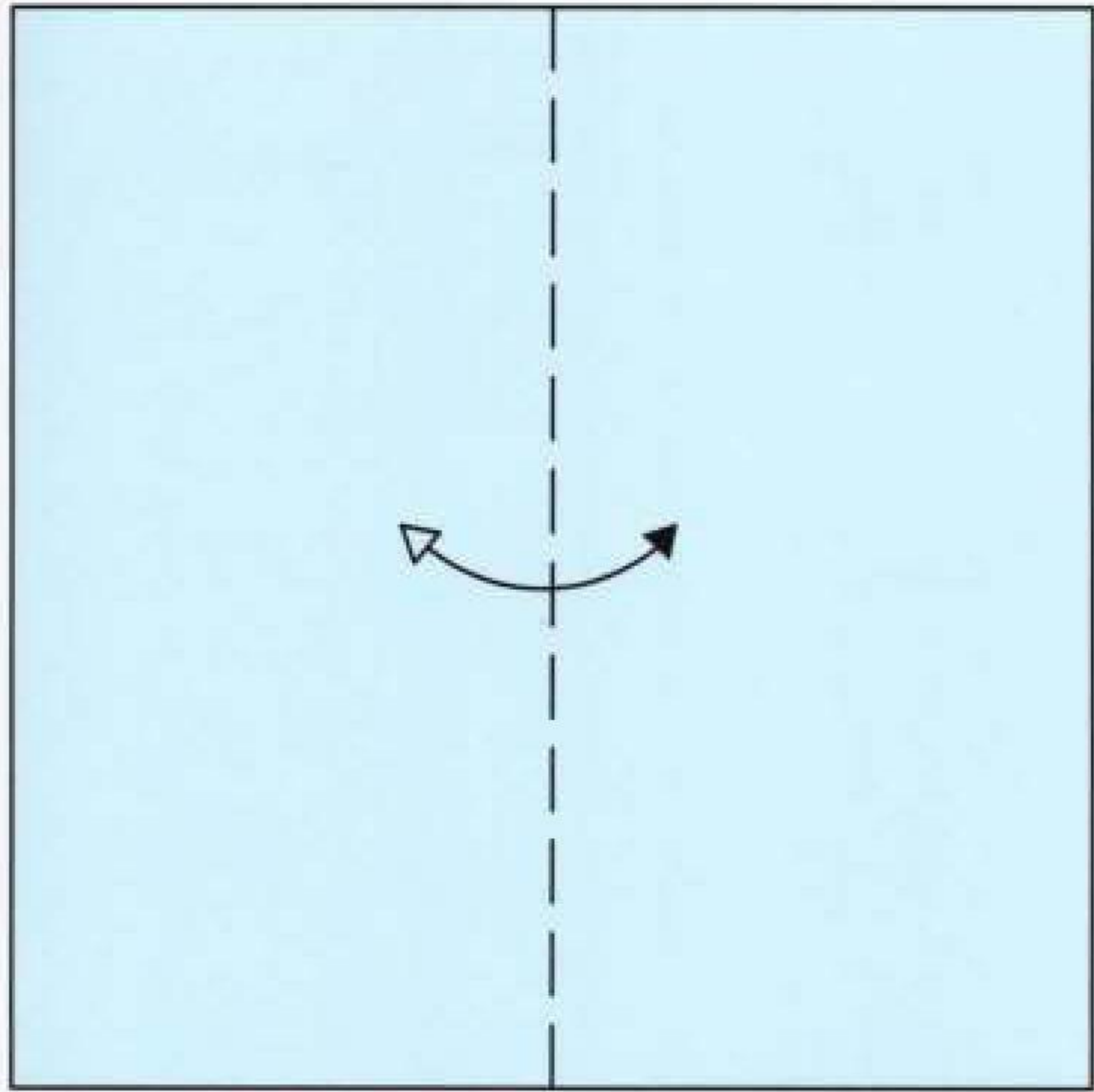

1. Valley fold and unfold

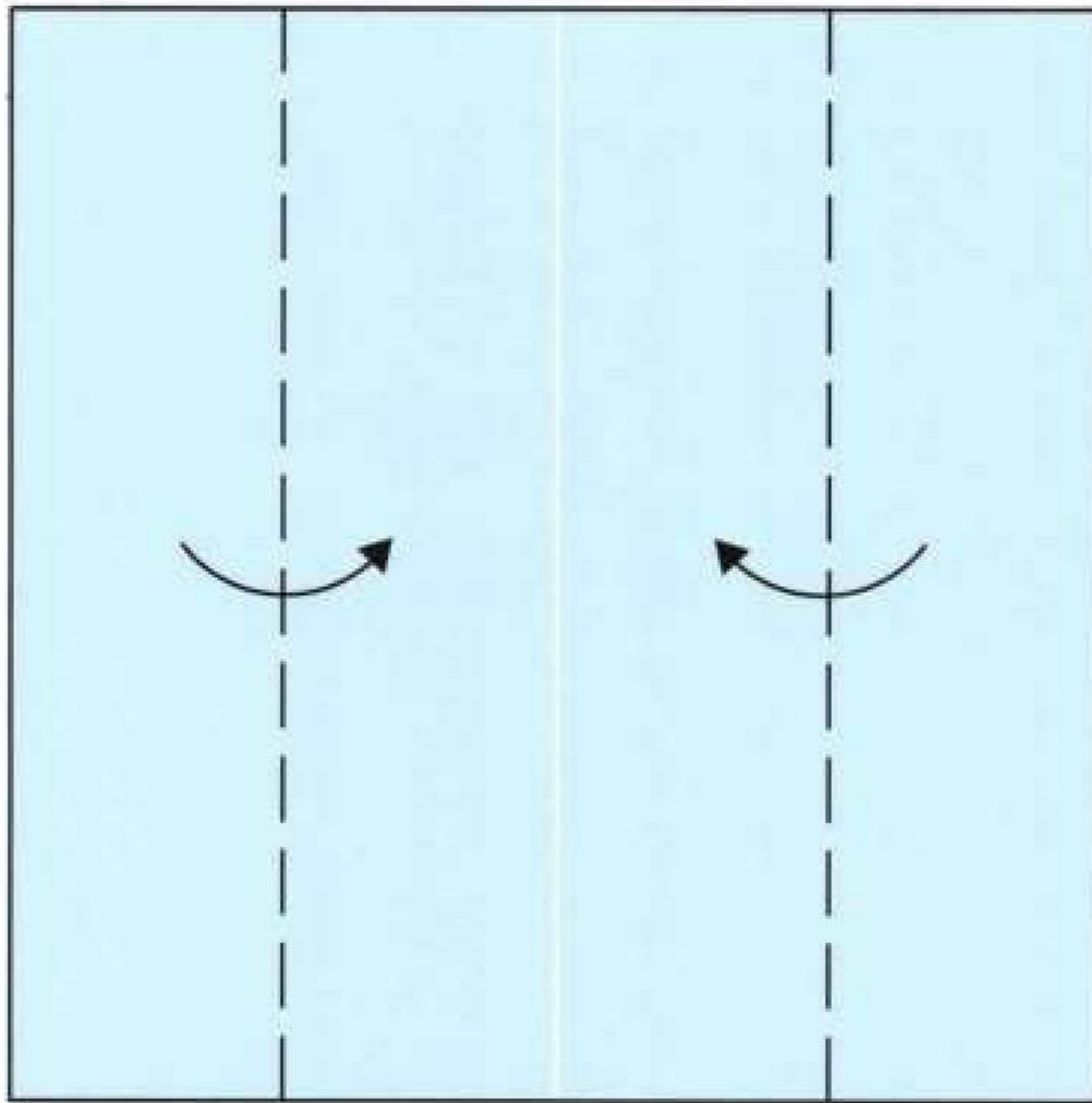

2. Valley folds

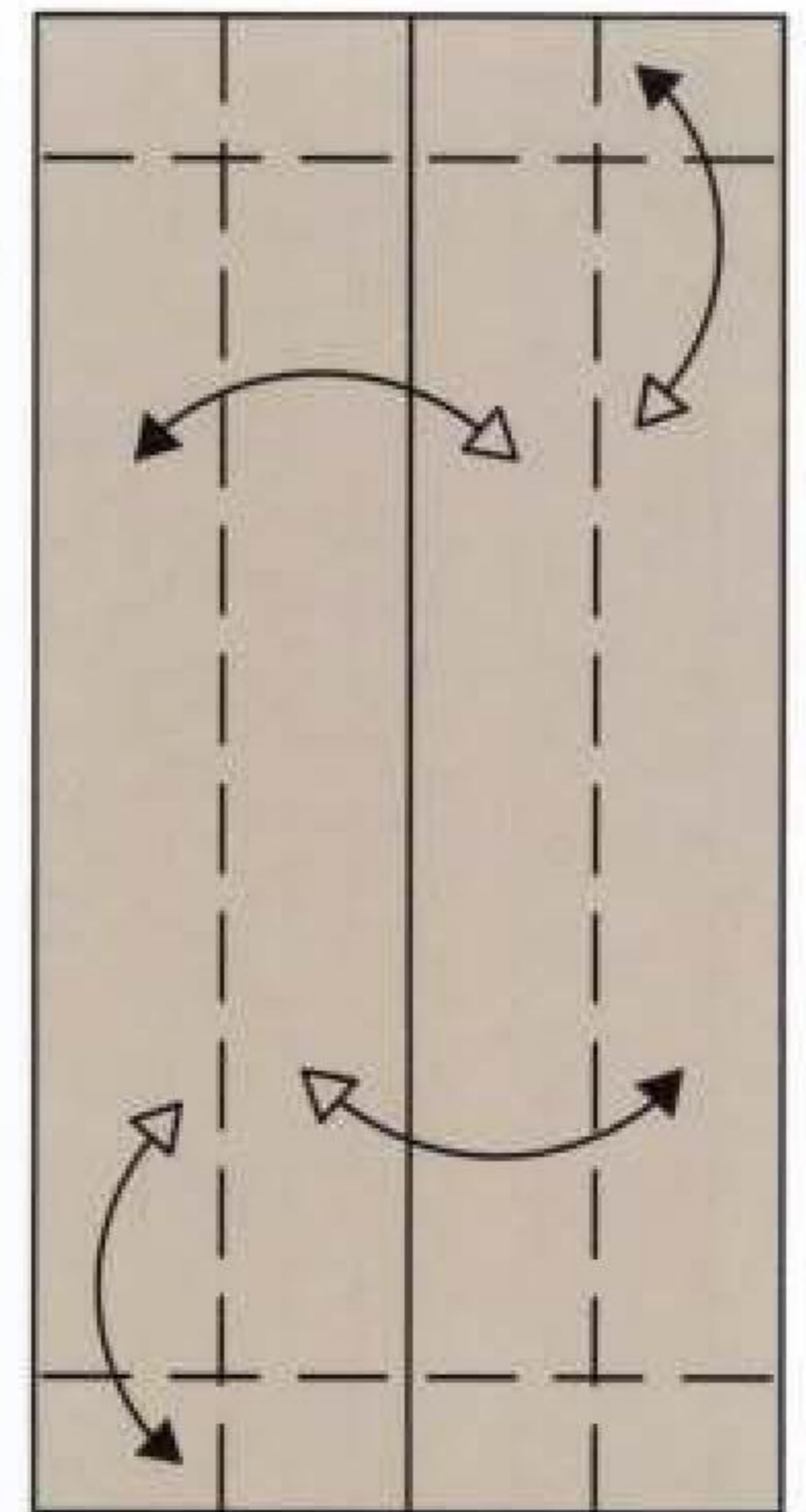

3. Valley folds and unfold

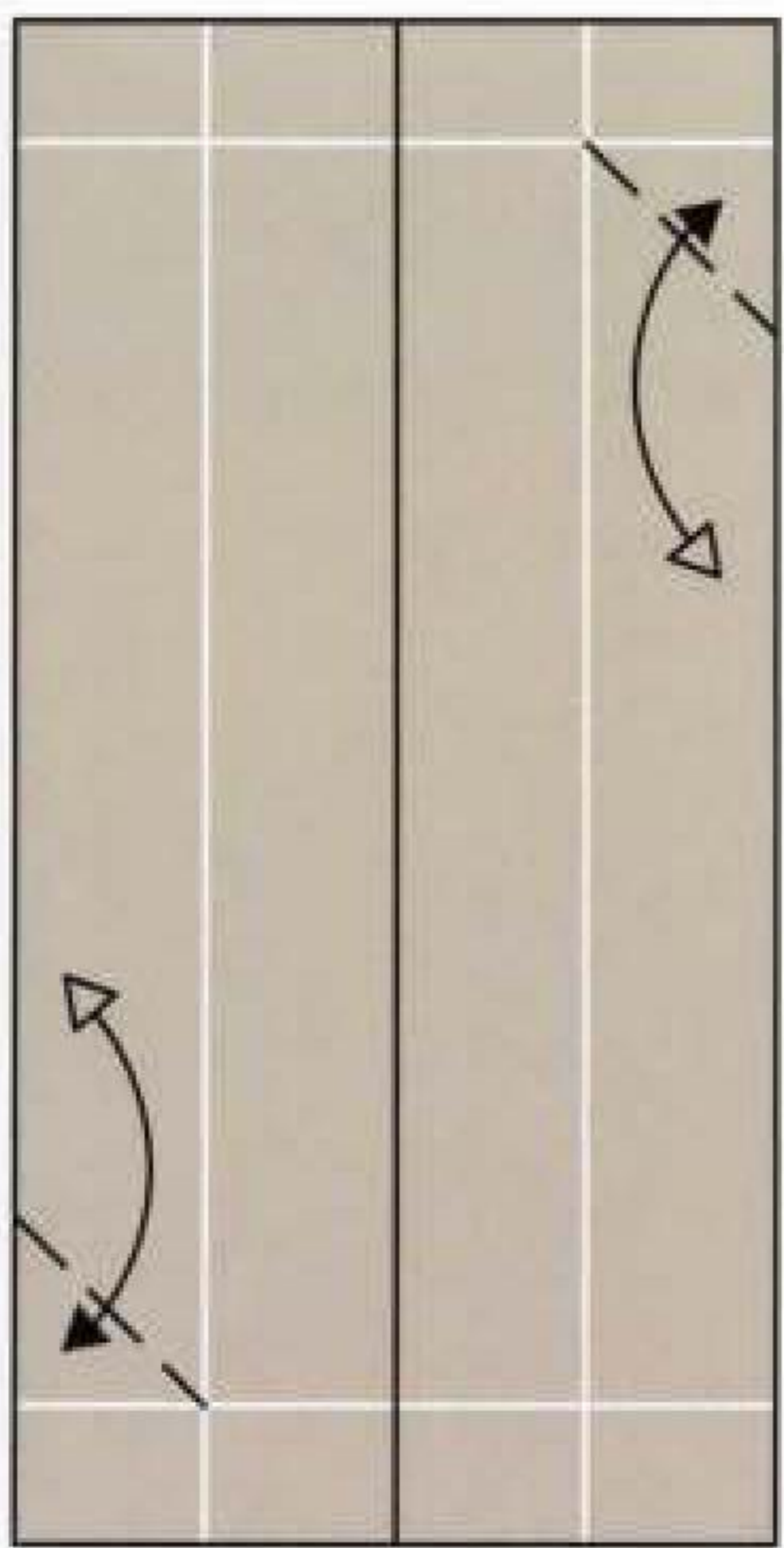

4. Repeat

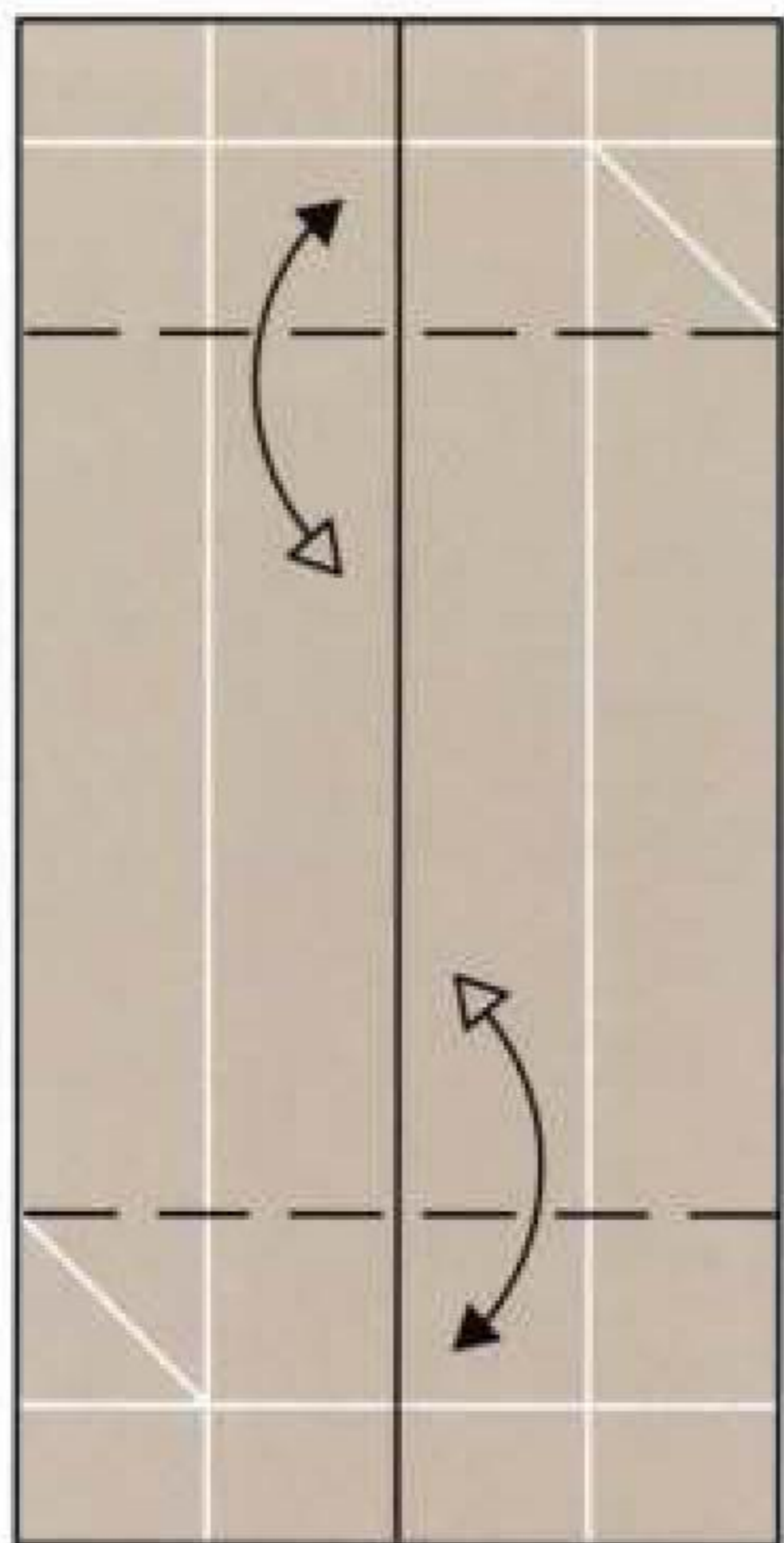

5. Valley folds and unfold

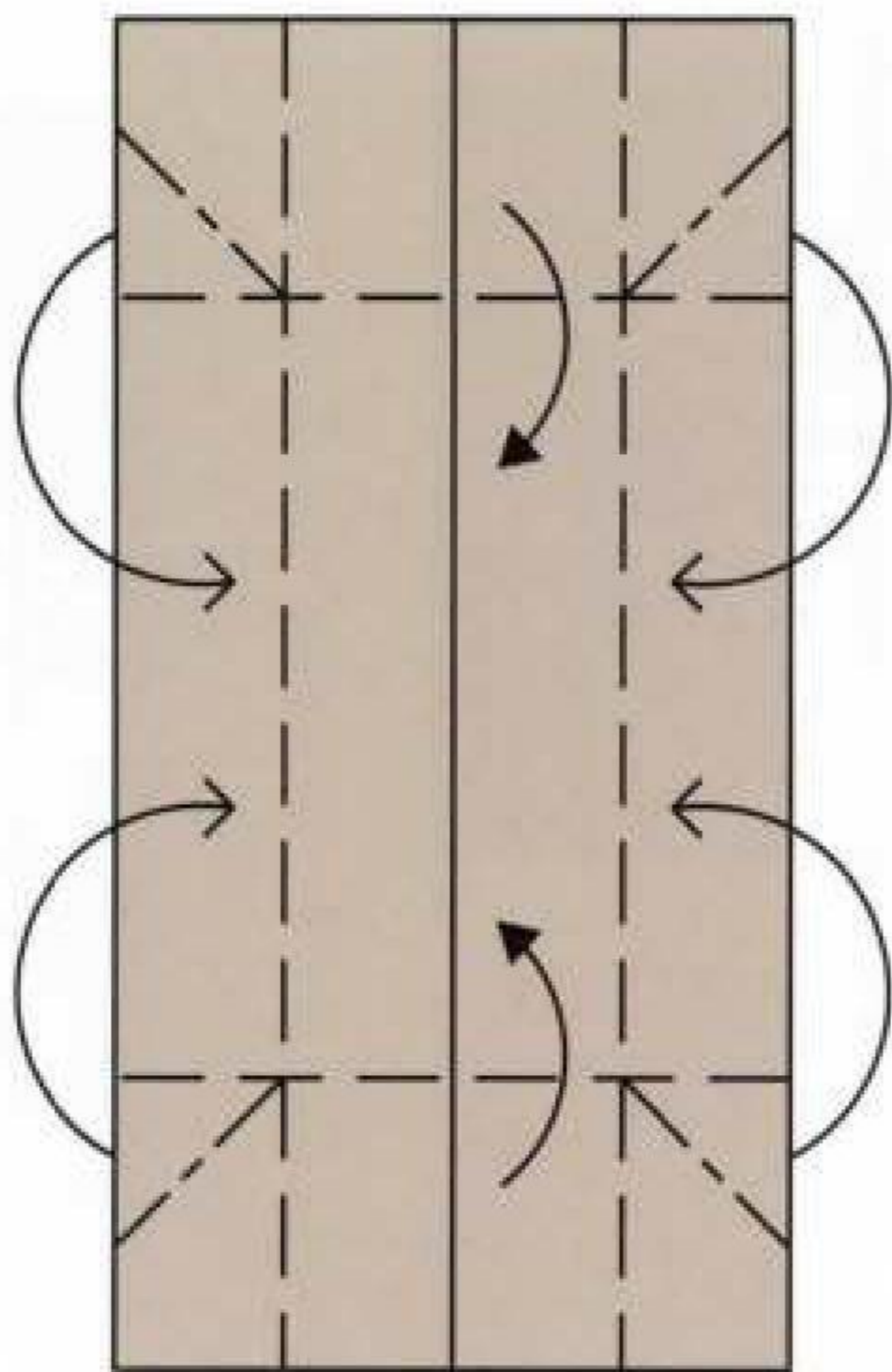

6. Valley folds and crimp folds



7. Valley fold the flaps at the top and bottom



8. Completed REFRIGERATOR PART 1

refrigerator: part 2

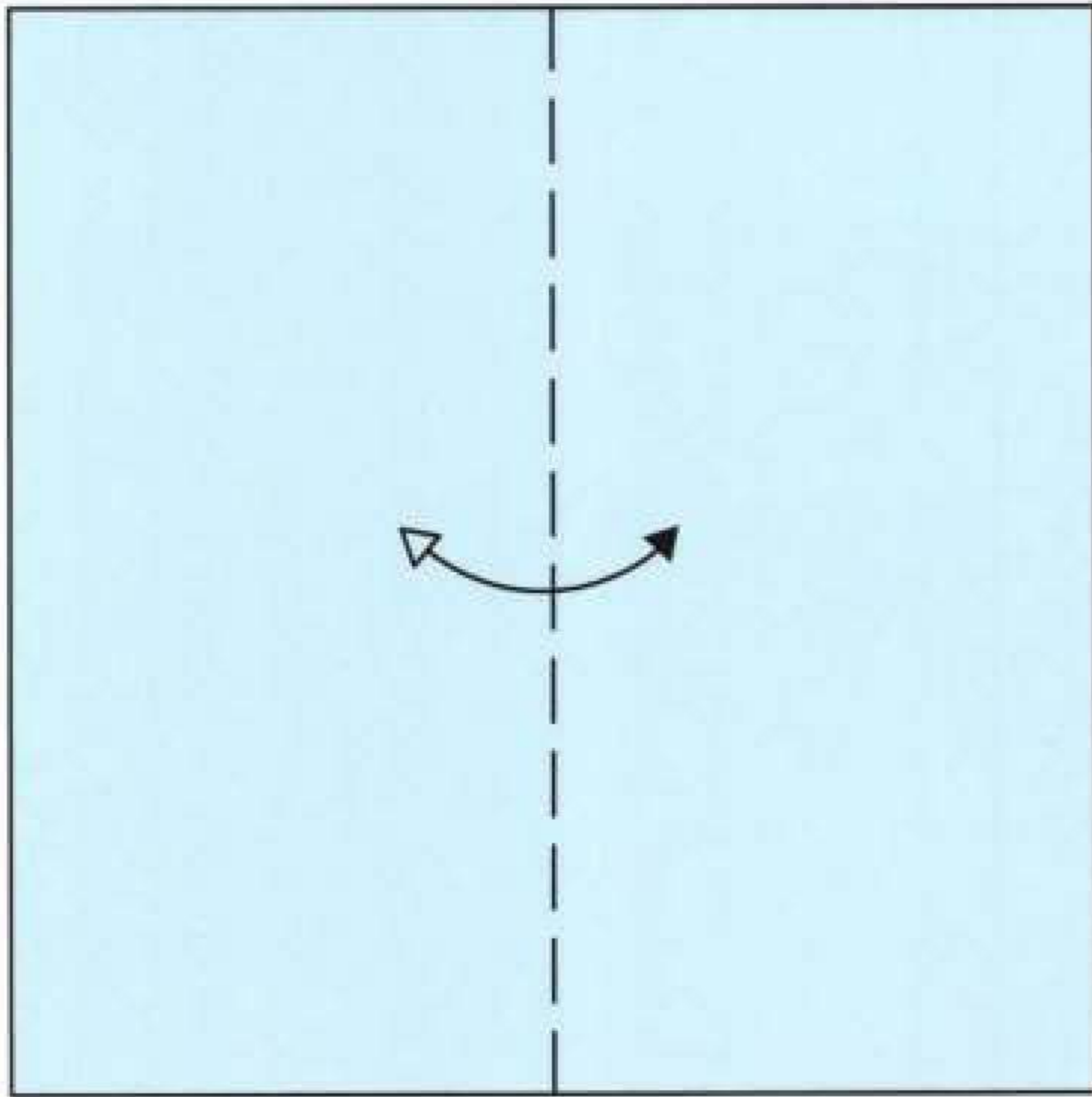

1. Valley fold and unfold

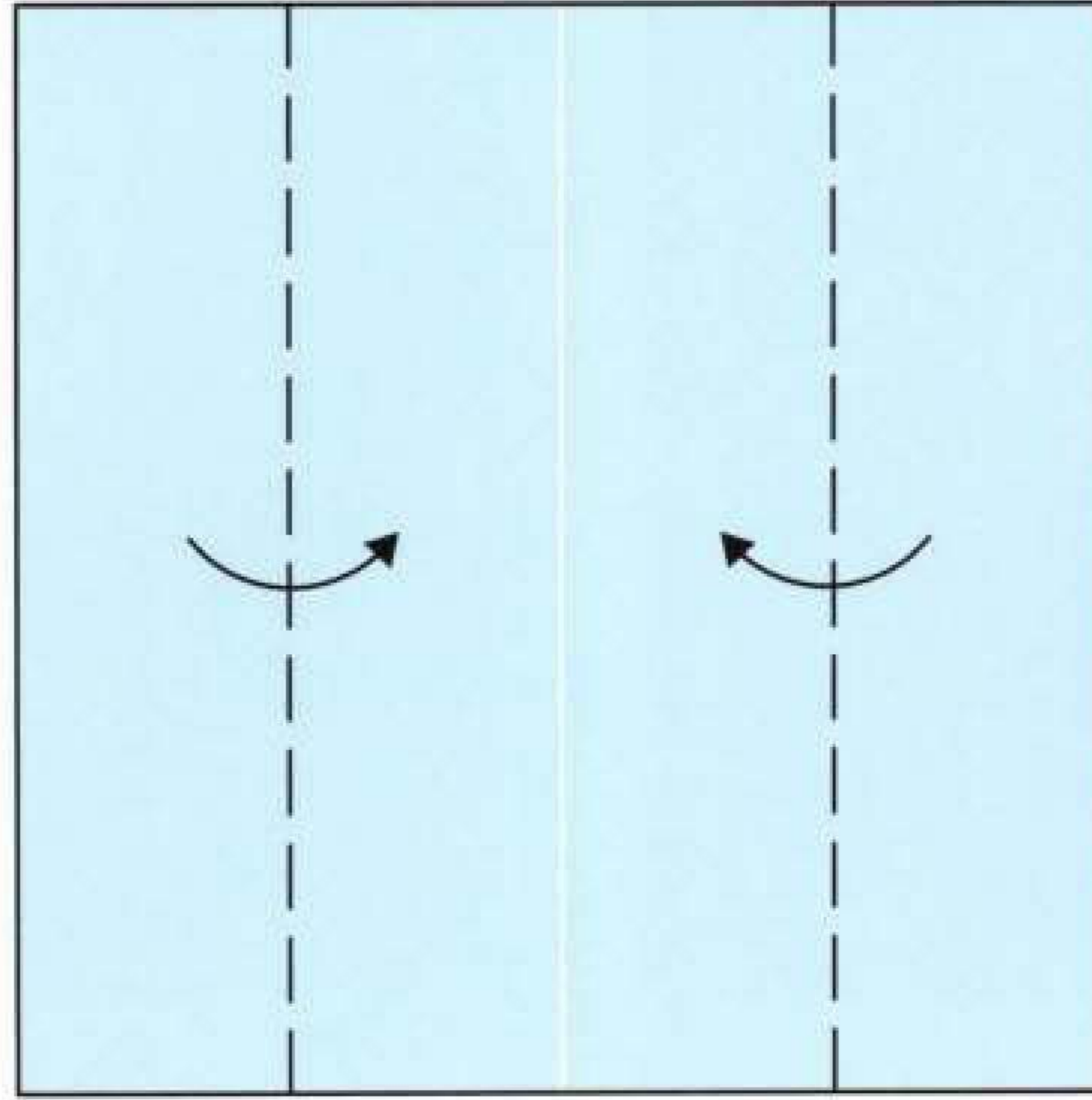

2. Valley folds

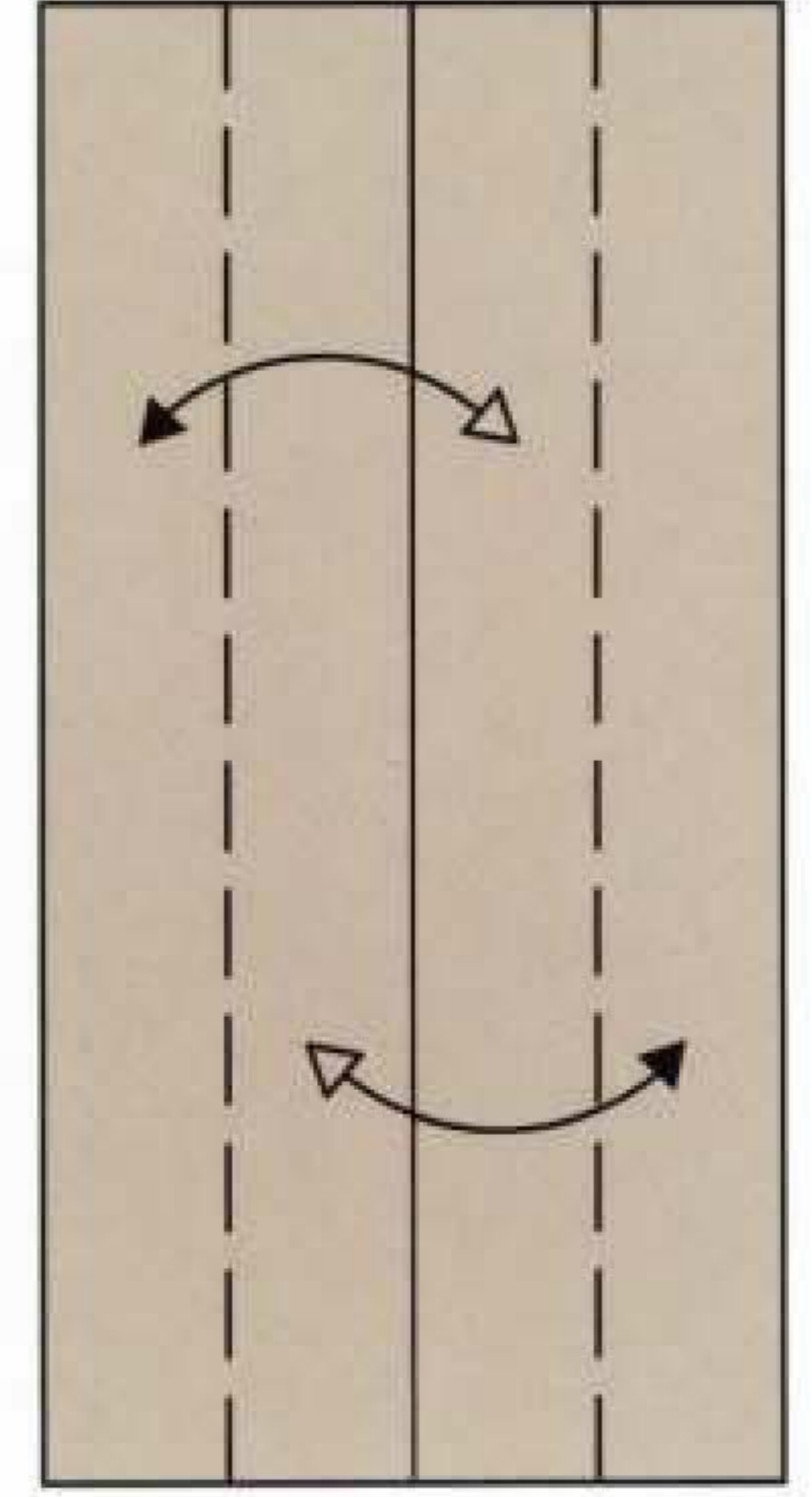

3. Valley folds and unfold

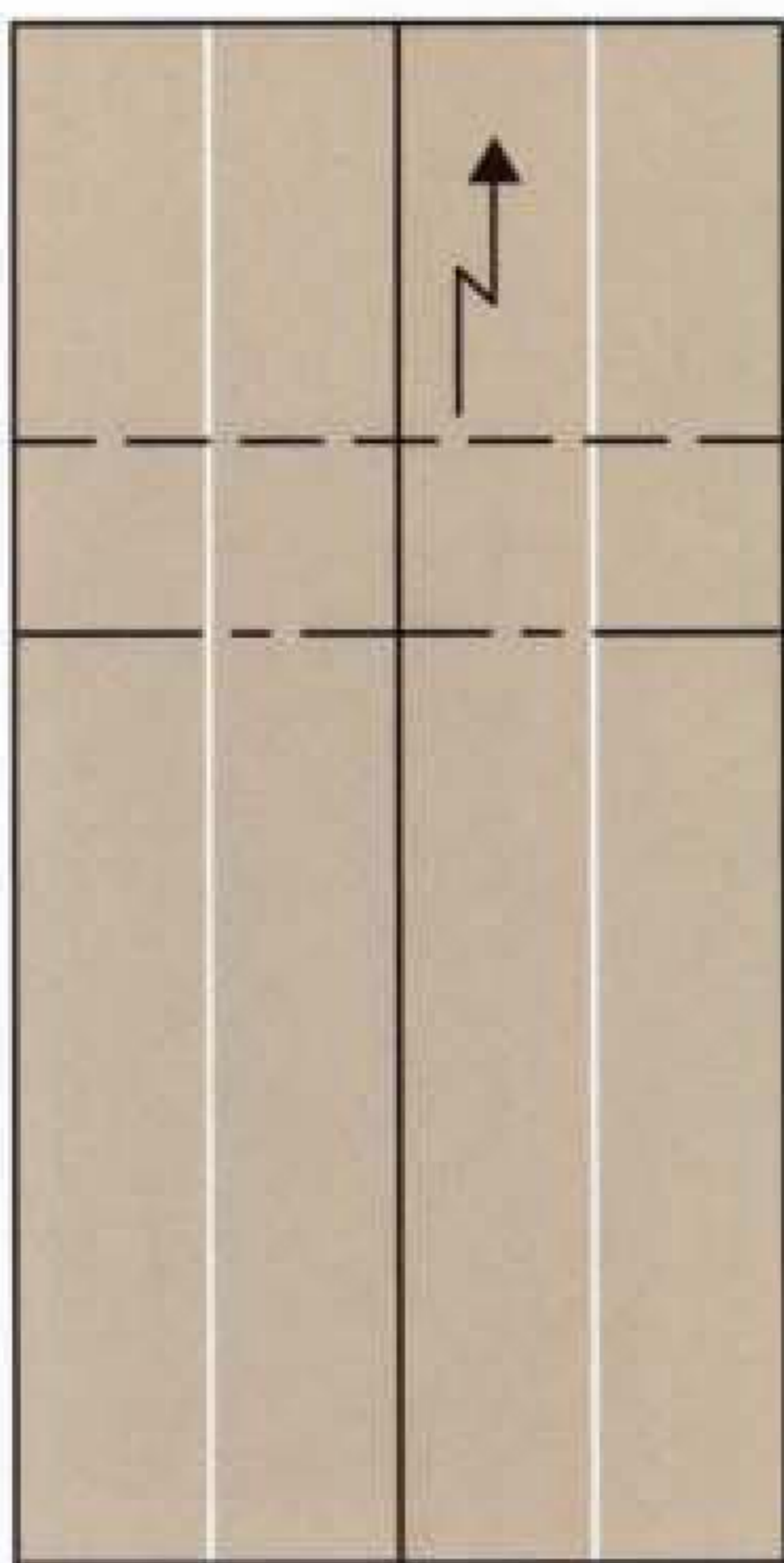

4. Pleat fold

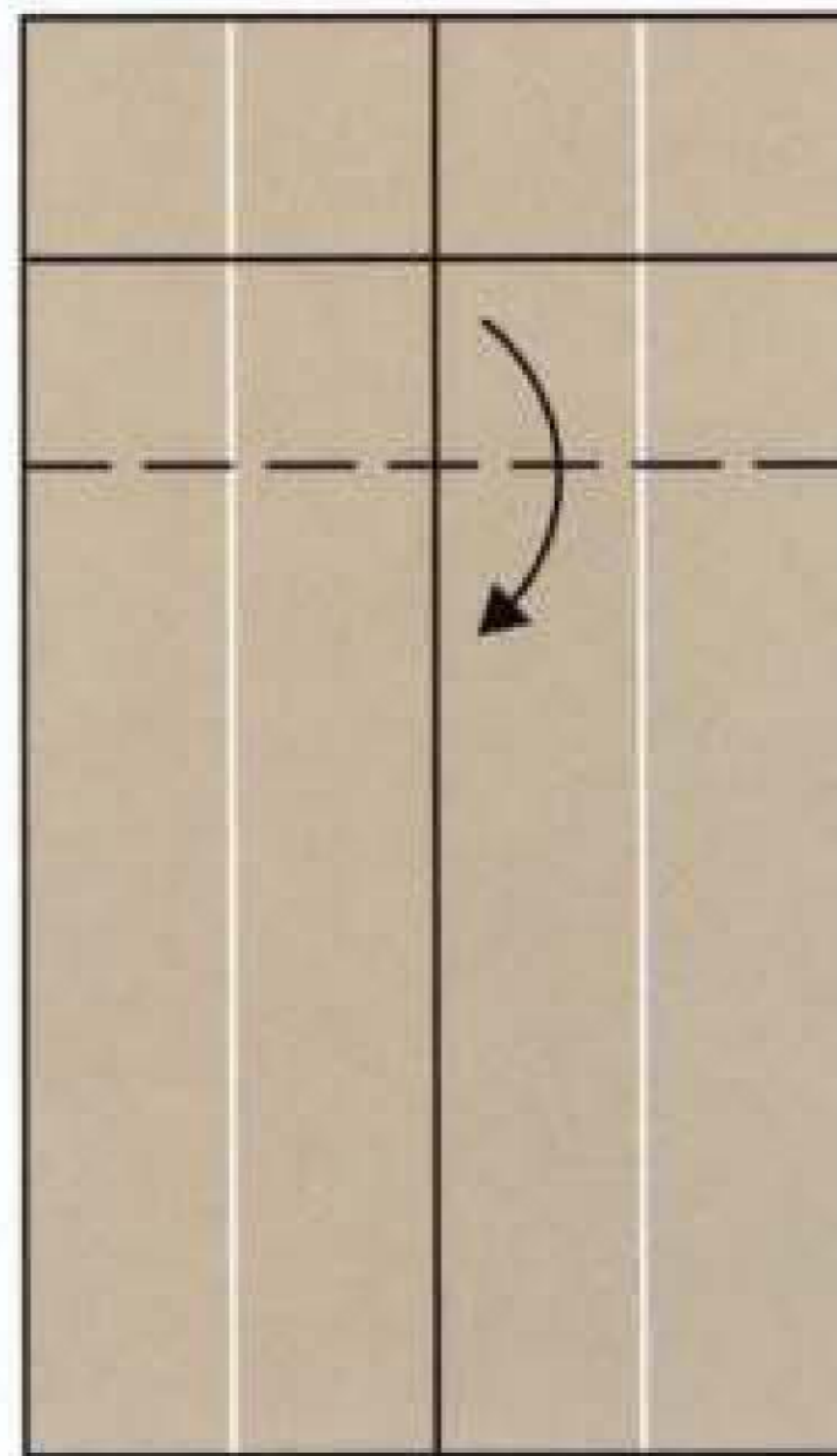

5. Valley fold

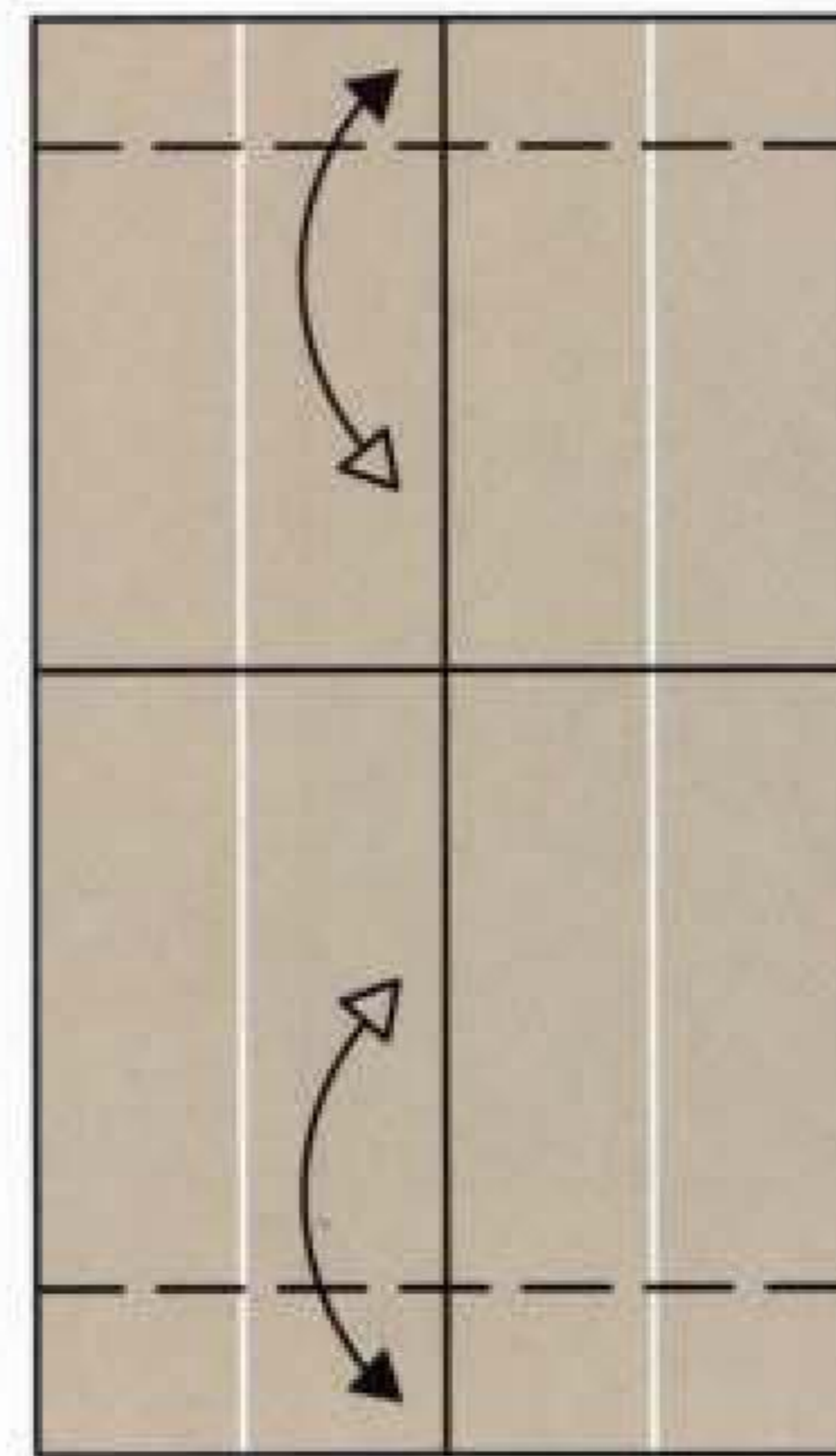

6. Valley folds and unfold

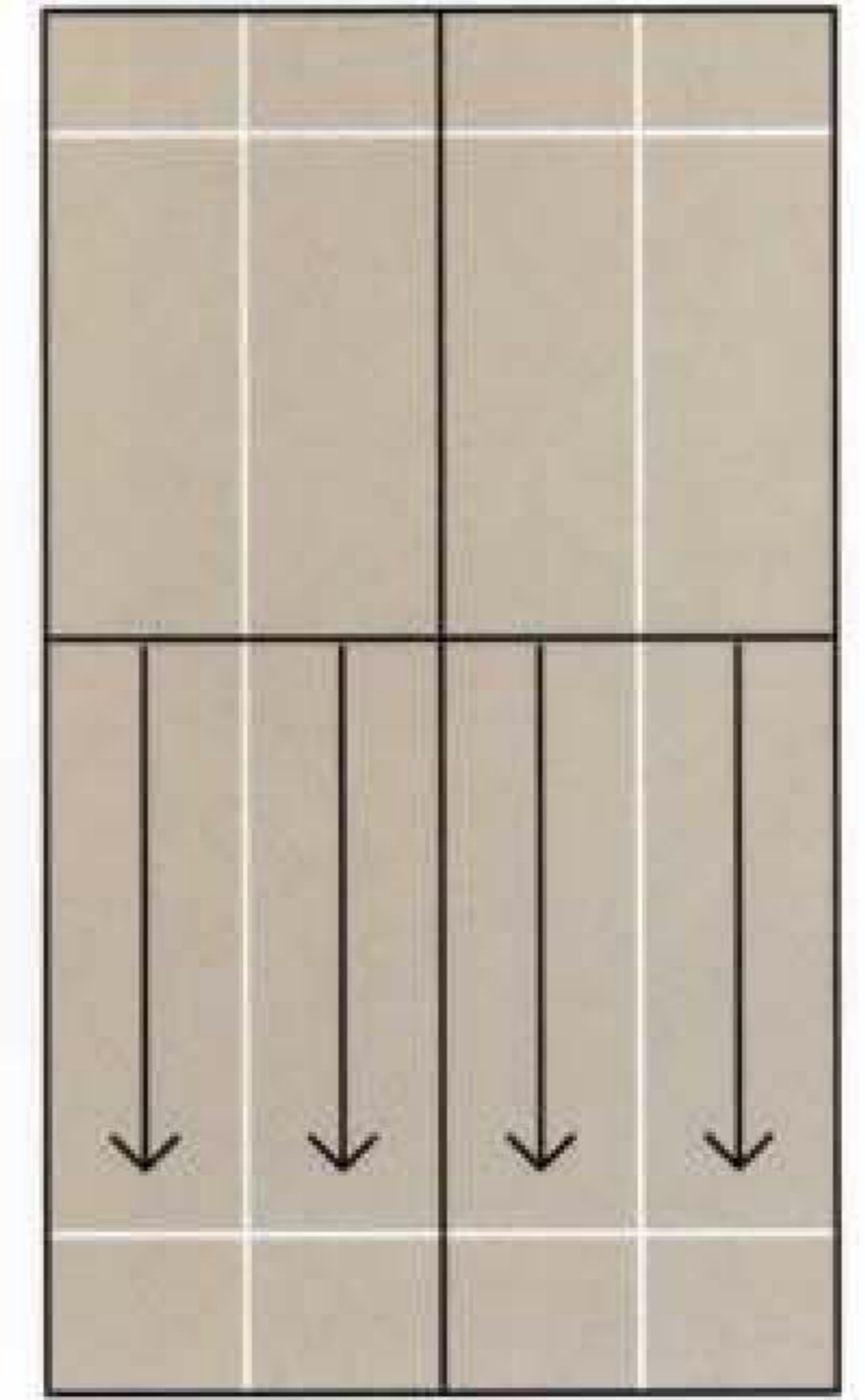

7. Pull to unfold

refrigerator: part 2

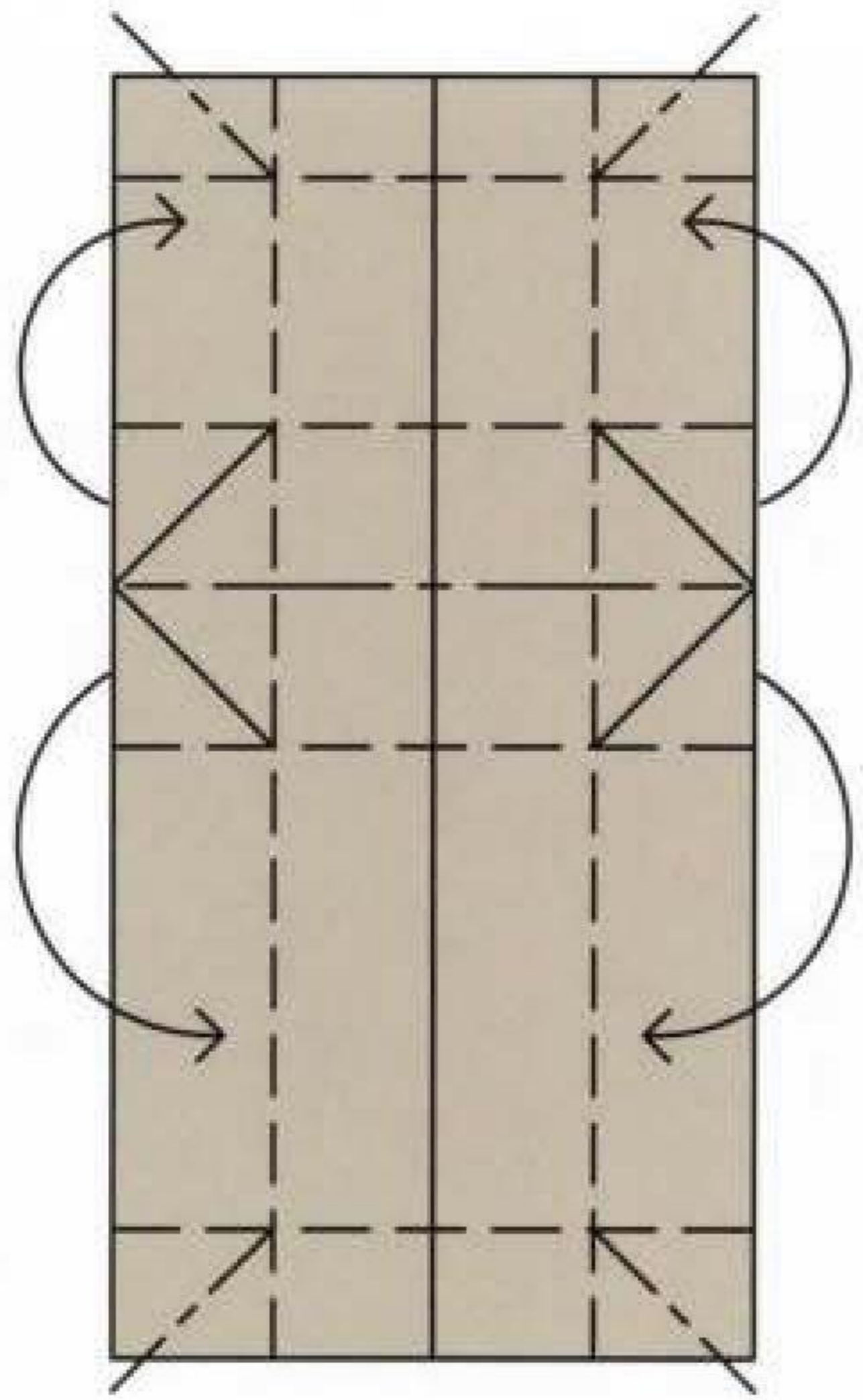

8. Valley folds and crimp folds at the same time

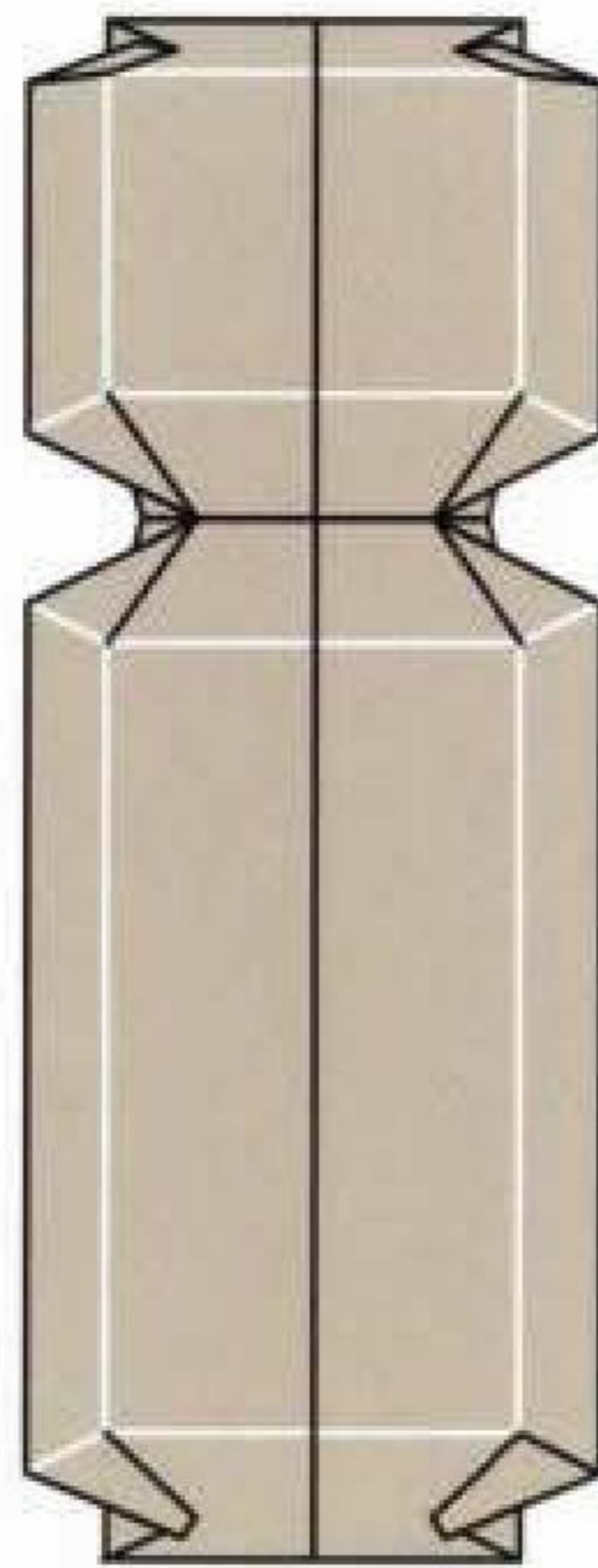

9. Before complete

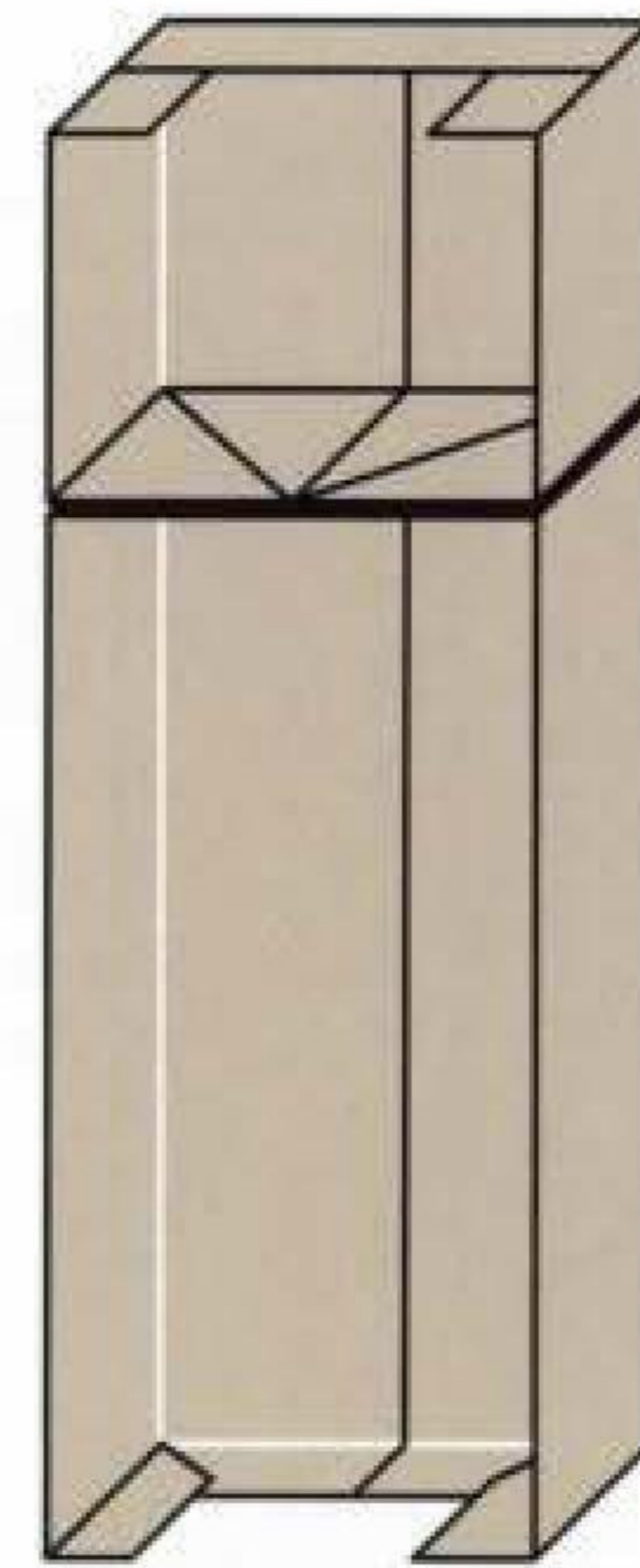

10. Completed
REFRIGERATOR PART 2

FIRST ASSEMBLY

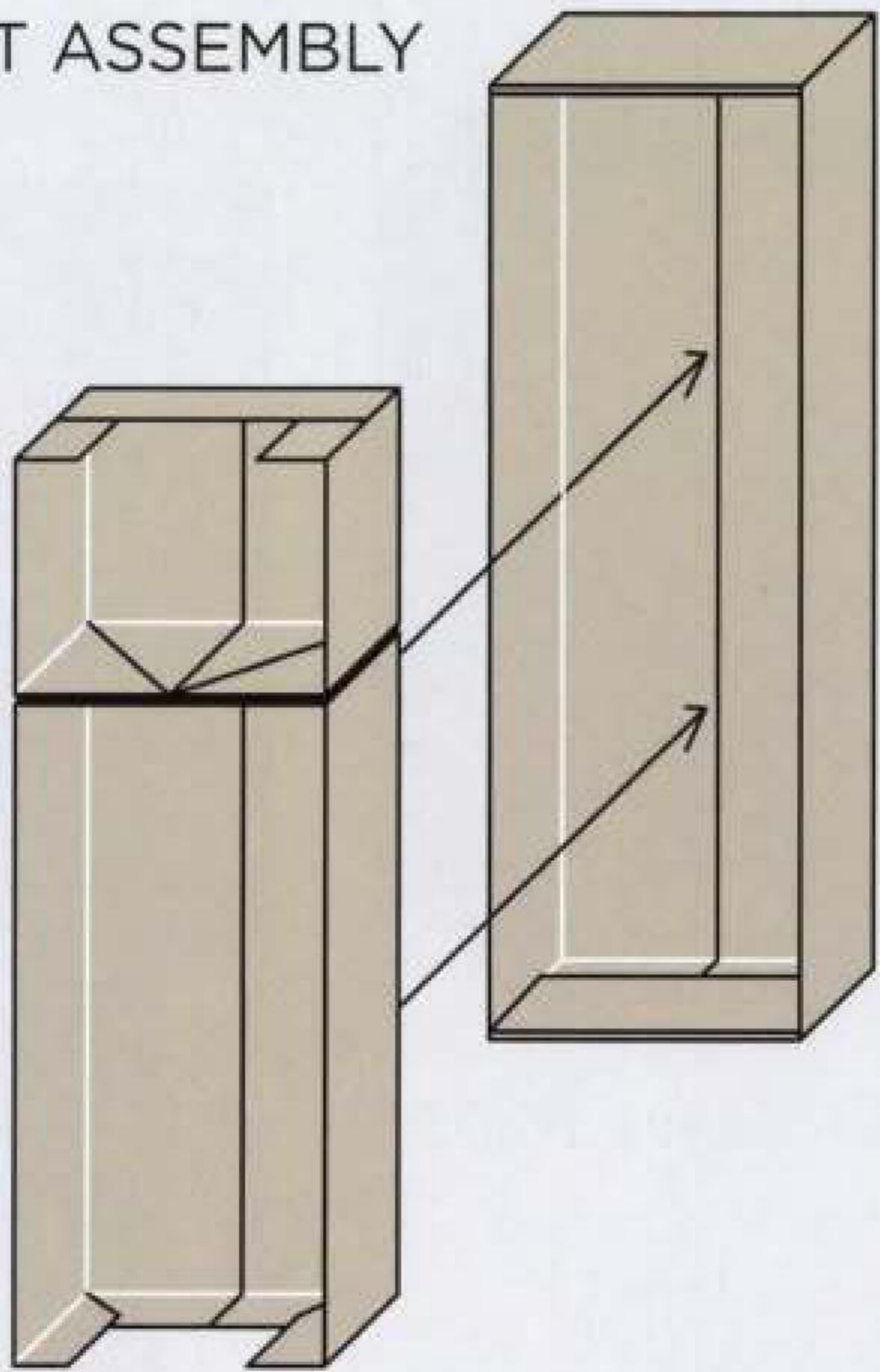

1. Insert Part 2 into Part 1
as the arrows indicate

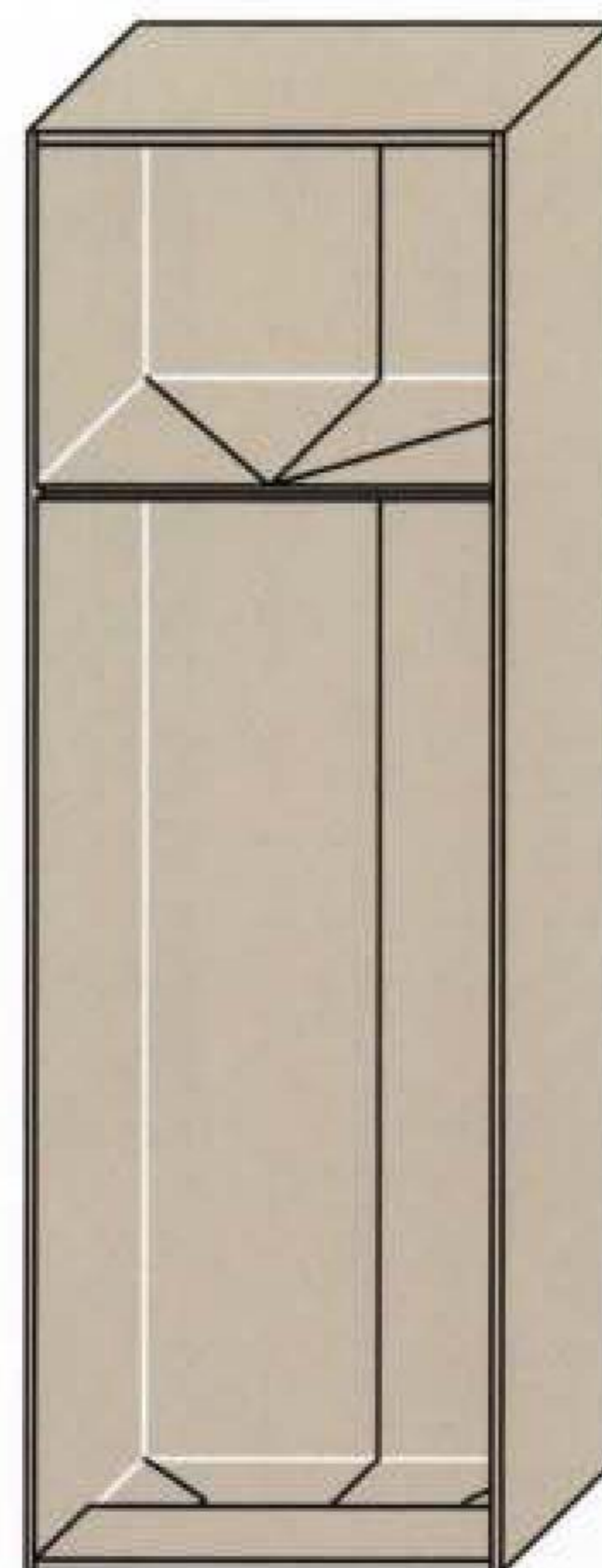

2. Completed
FIRST ASSEMBLY

refrigerator: part 3

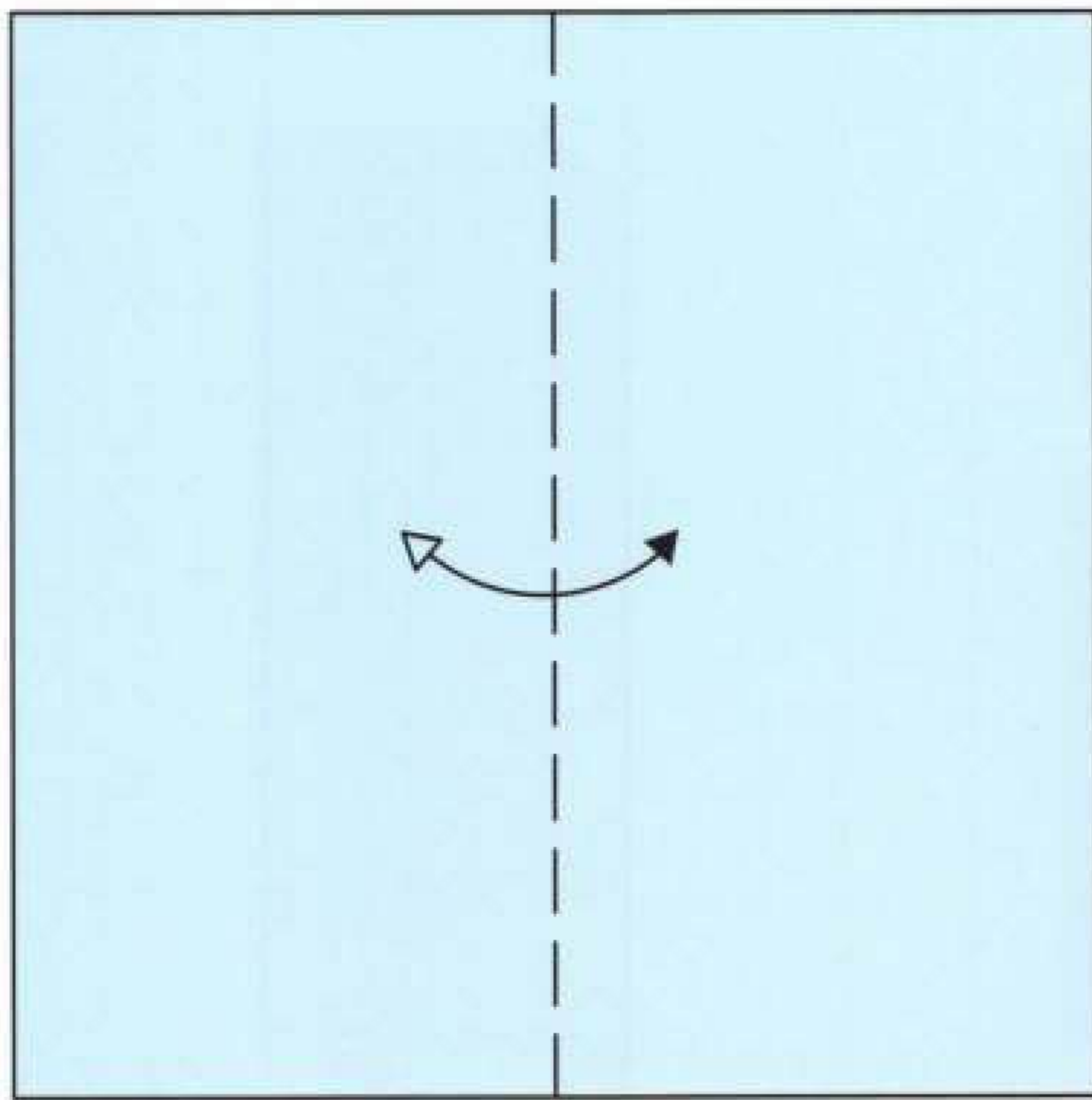

1. Valley fold and unfold

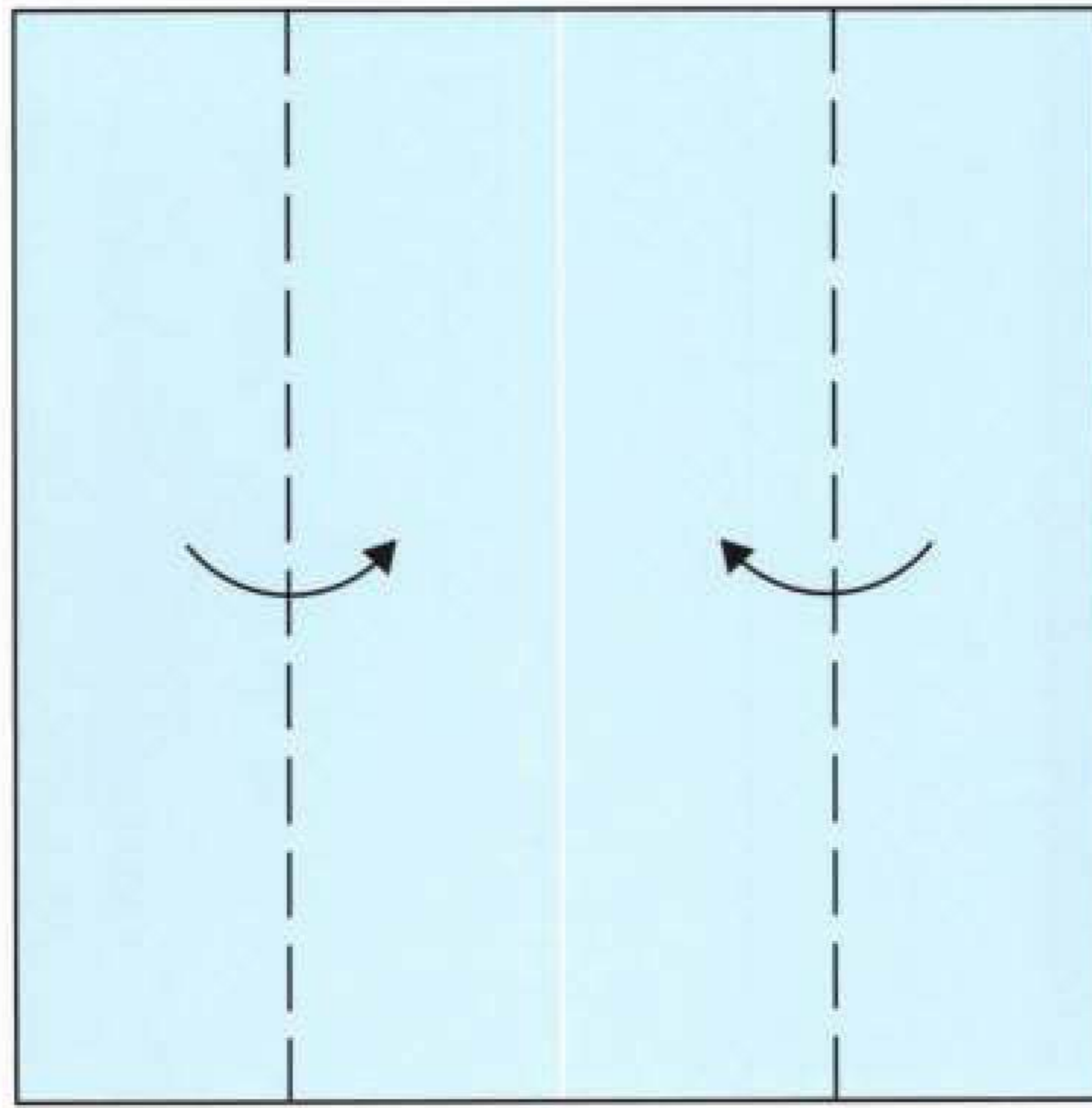

2. Valley folds

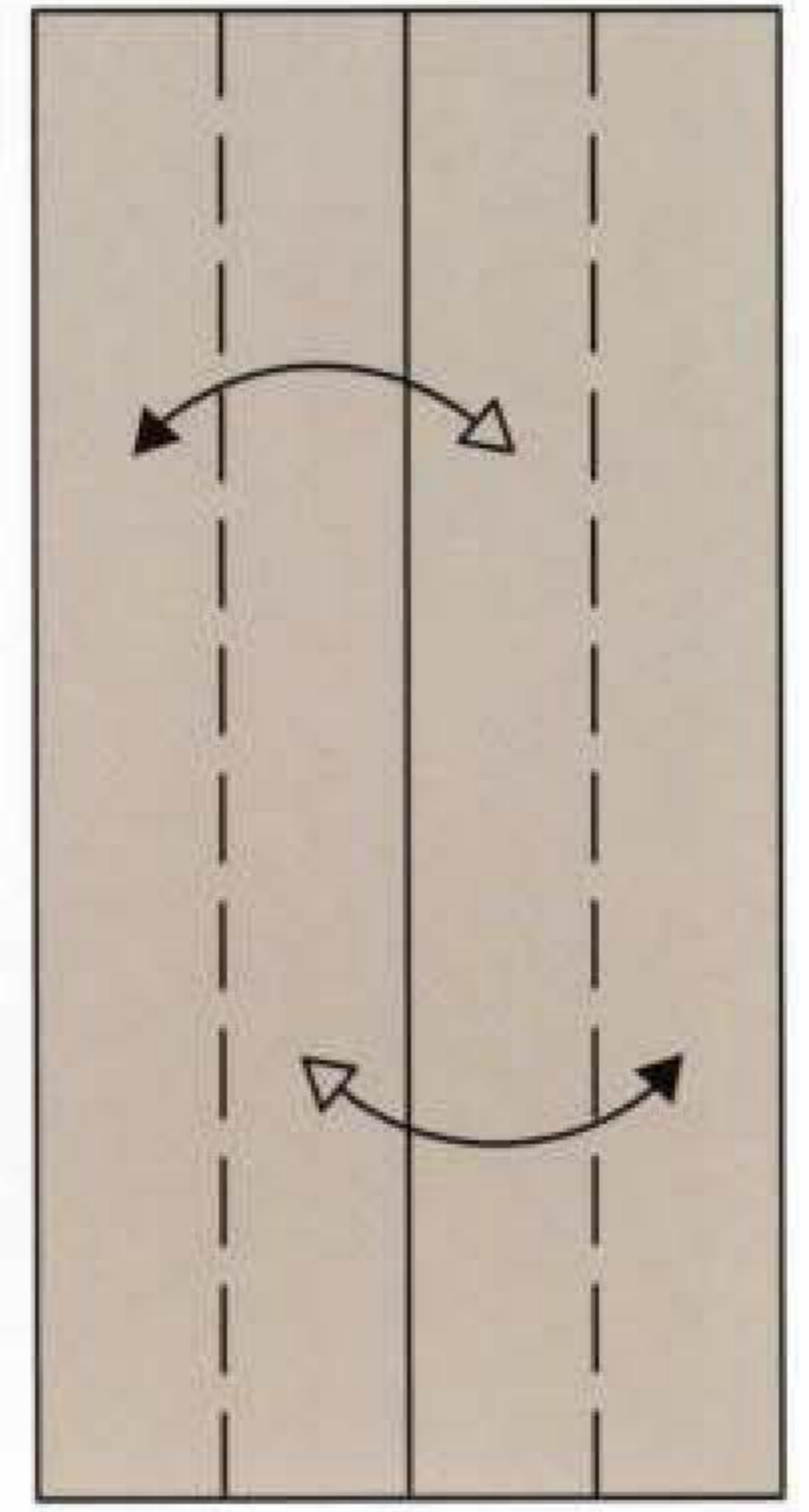

3. Valley folds and unfold



4. Valley folds

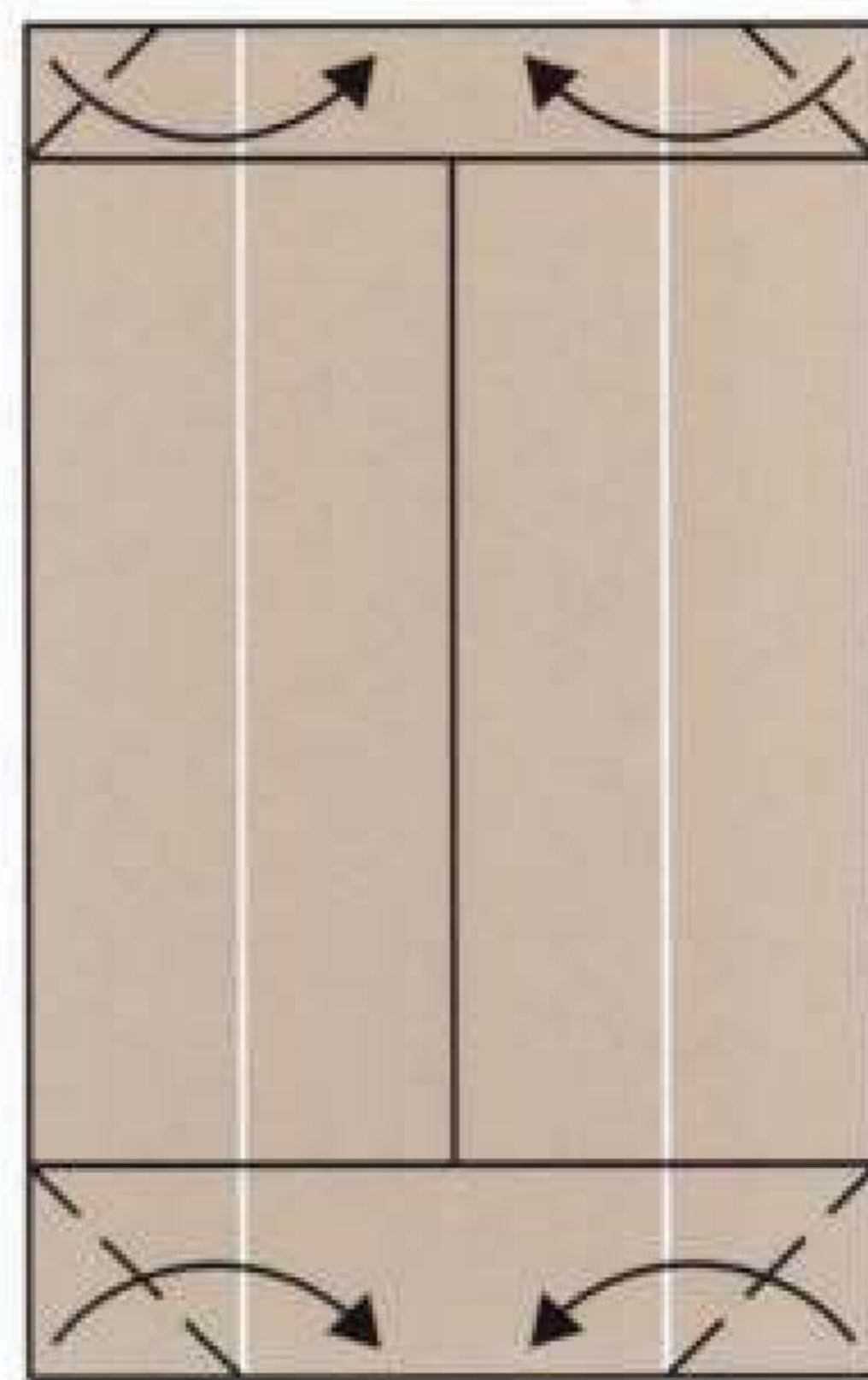

5. Valley folds

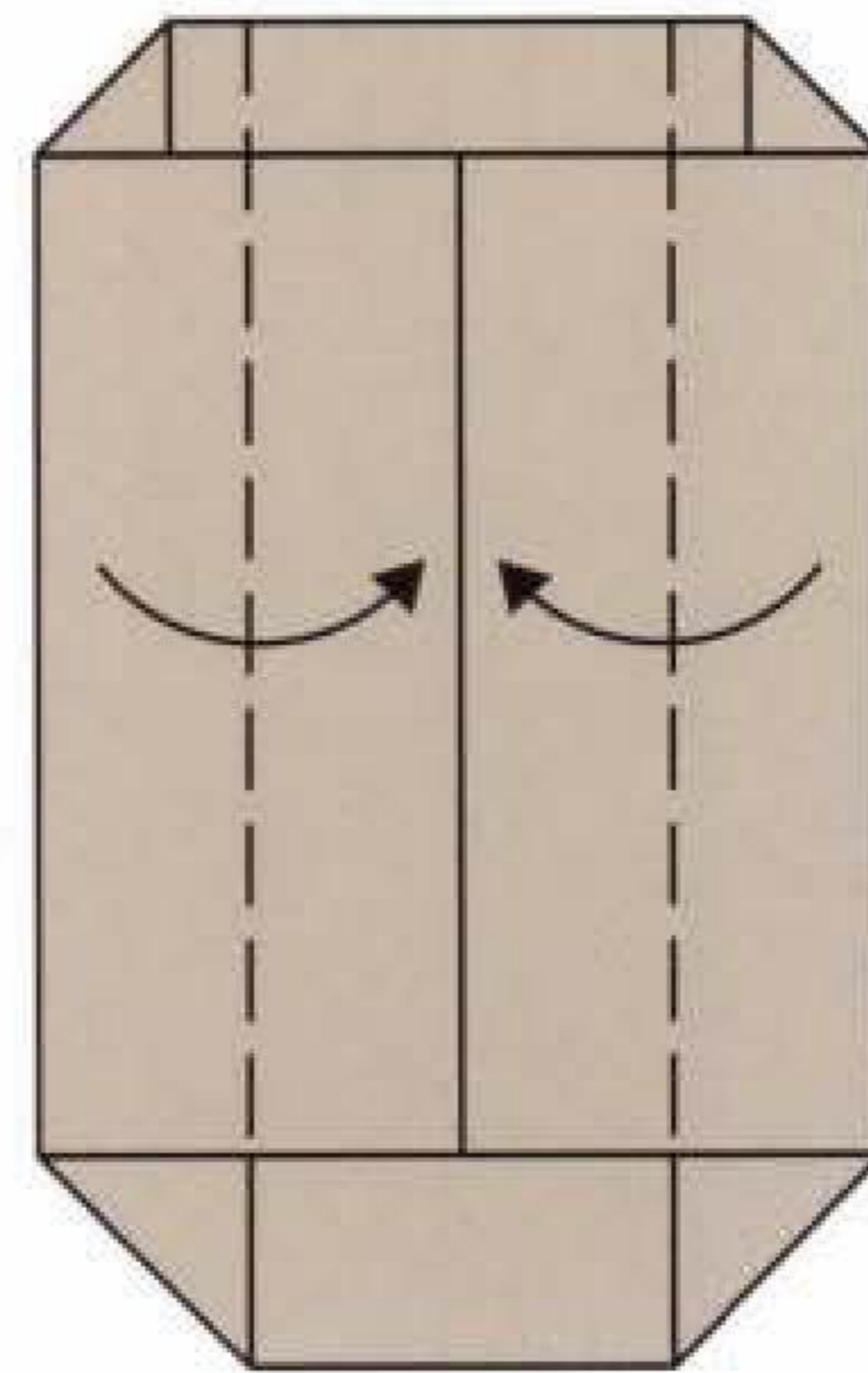

6. Valley folds

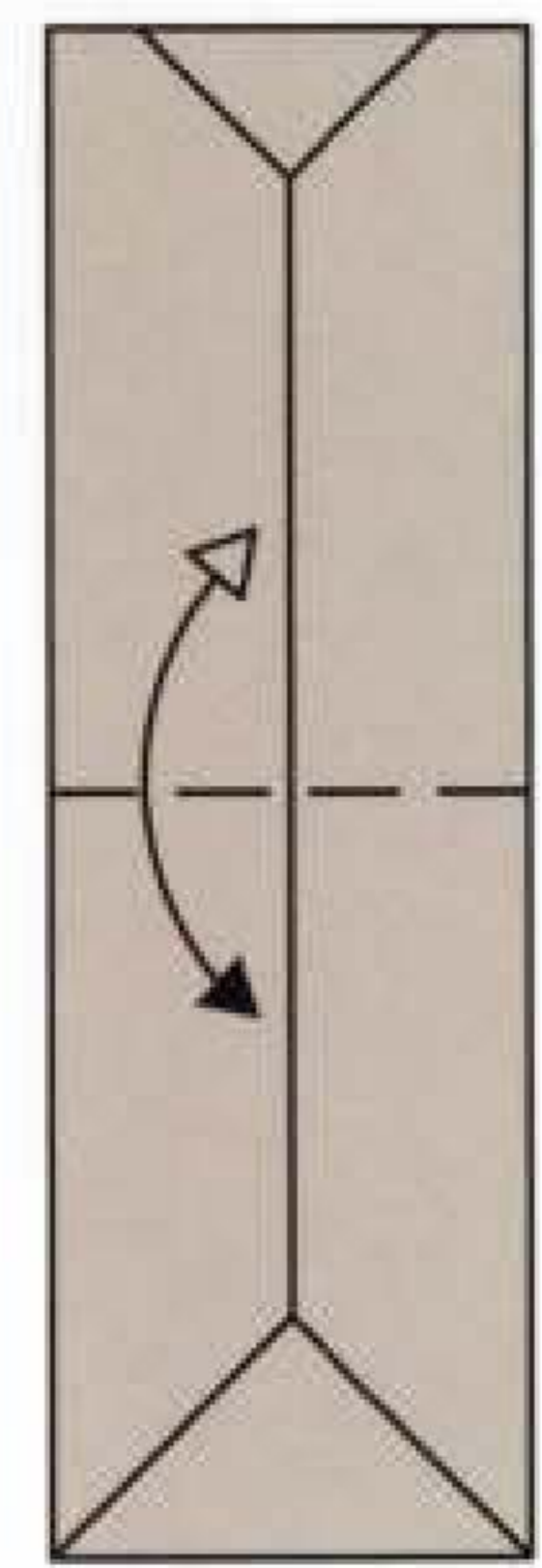

7. Valley fold and unfold

refrigerator: part 3

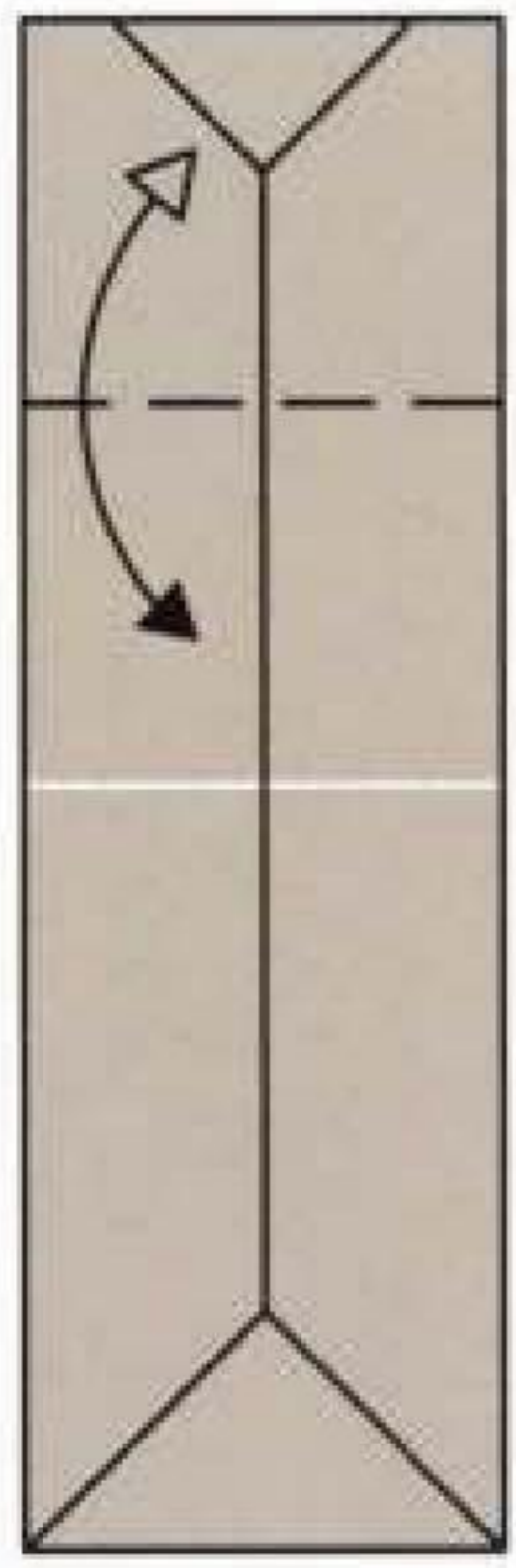

8. Valley fold and unfold

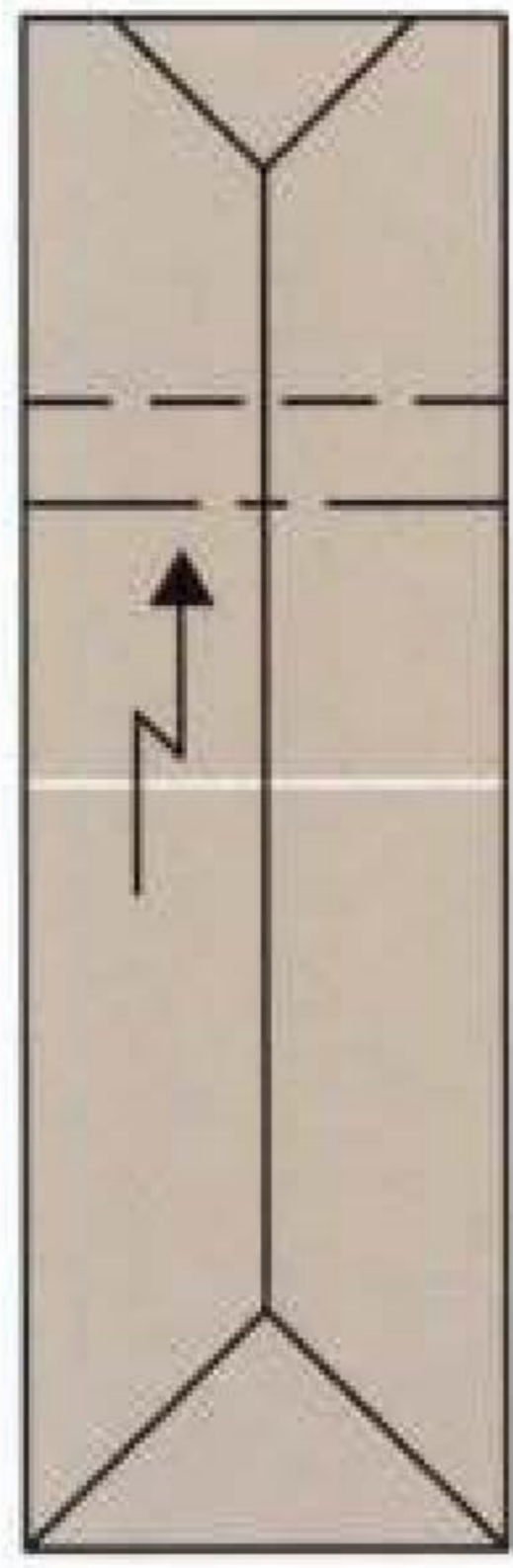

9. Pleat fold



10. Turn over

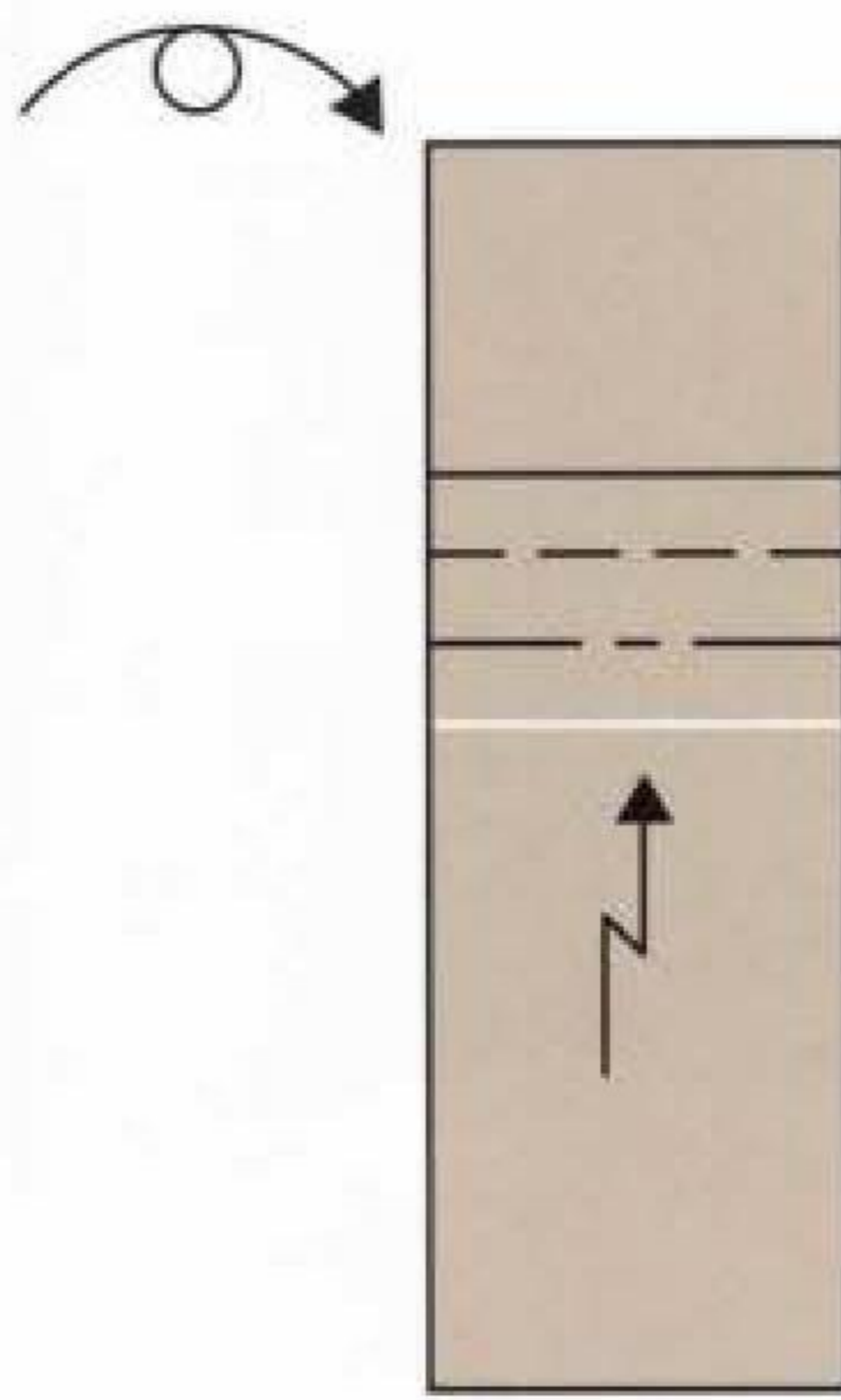

11. Pleat fold



12. Turn over

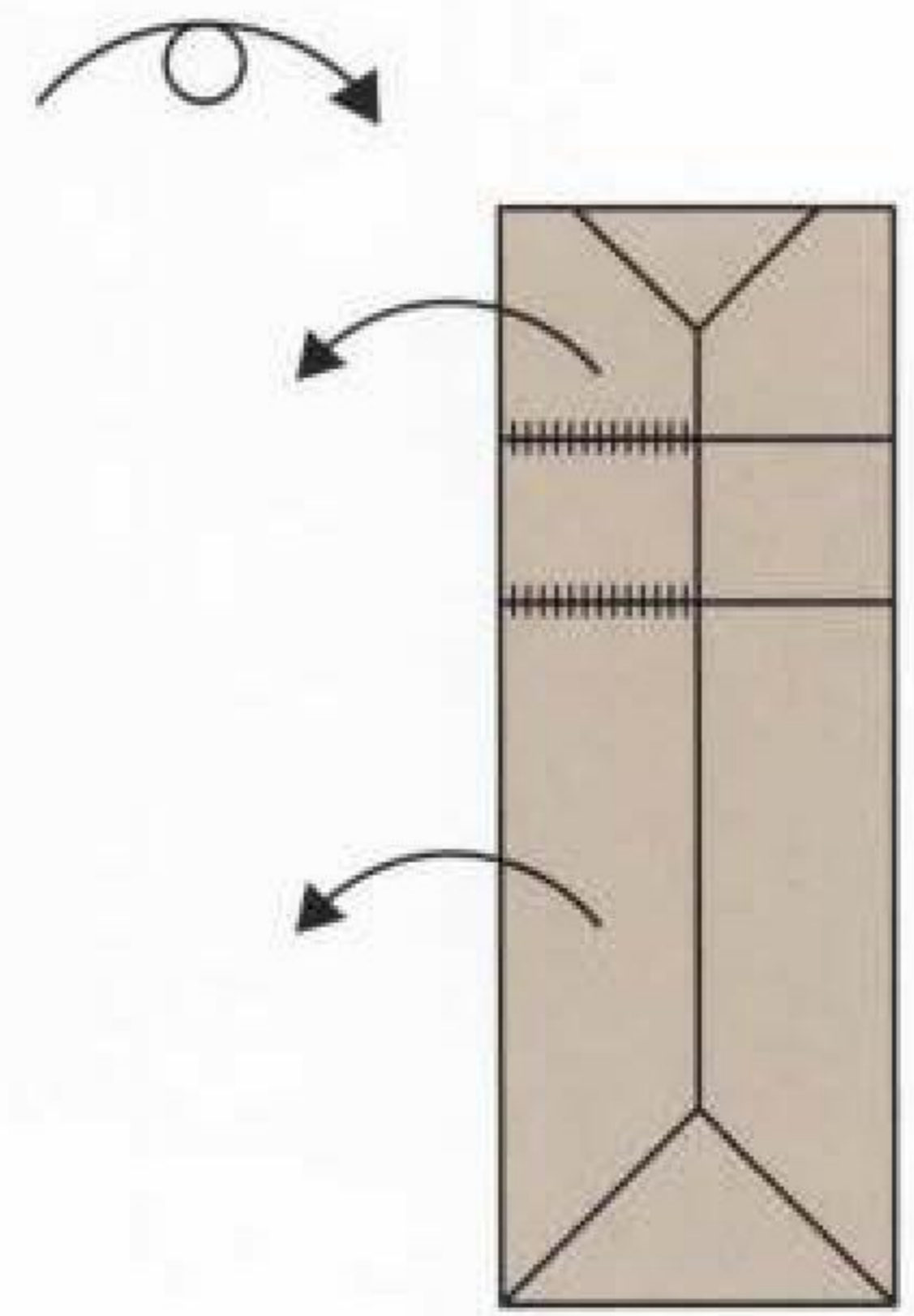

13. Cuts and valley folds

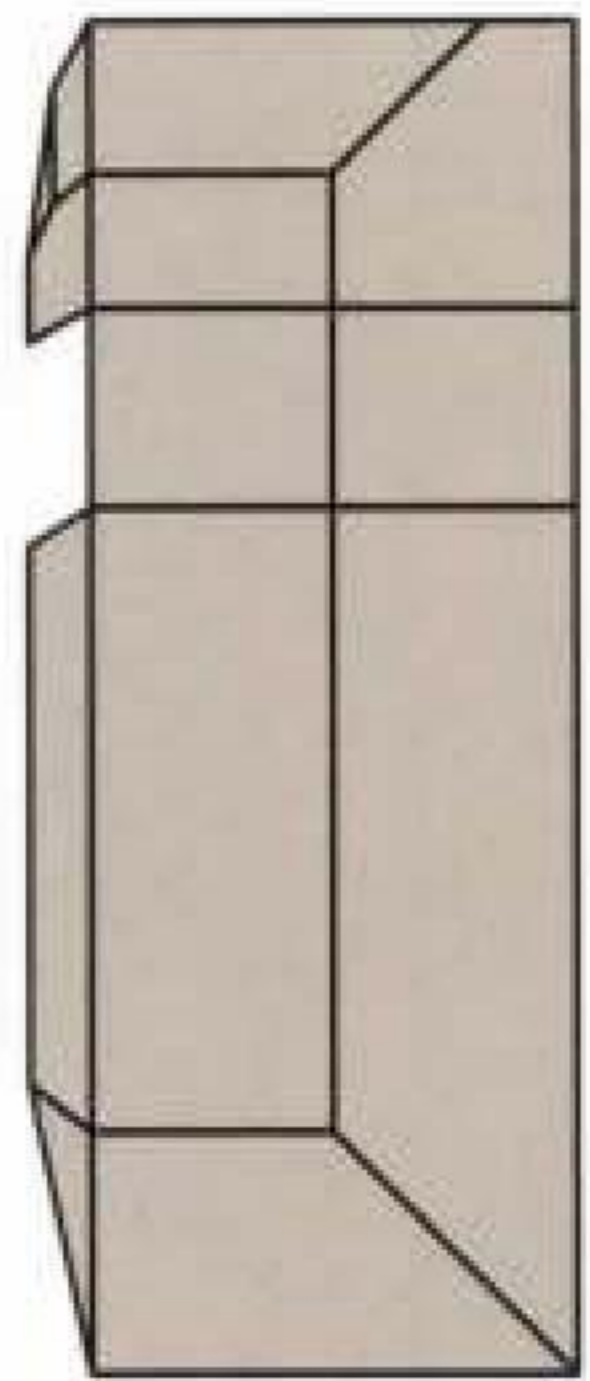

14. Completed PART 3

SECOND ASSEMBLY

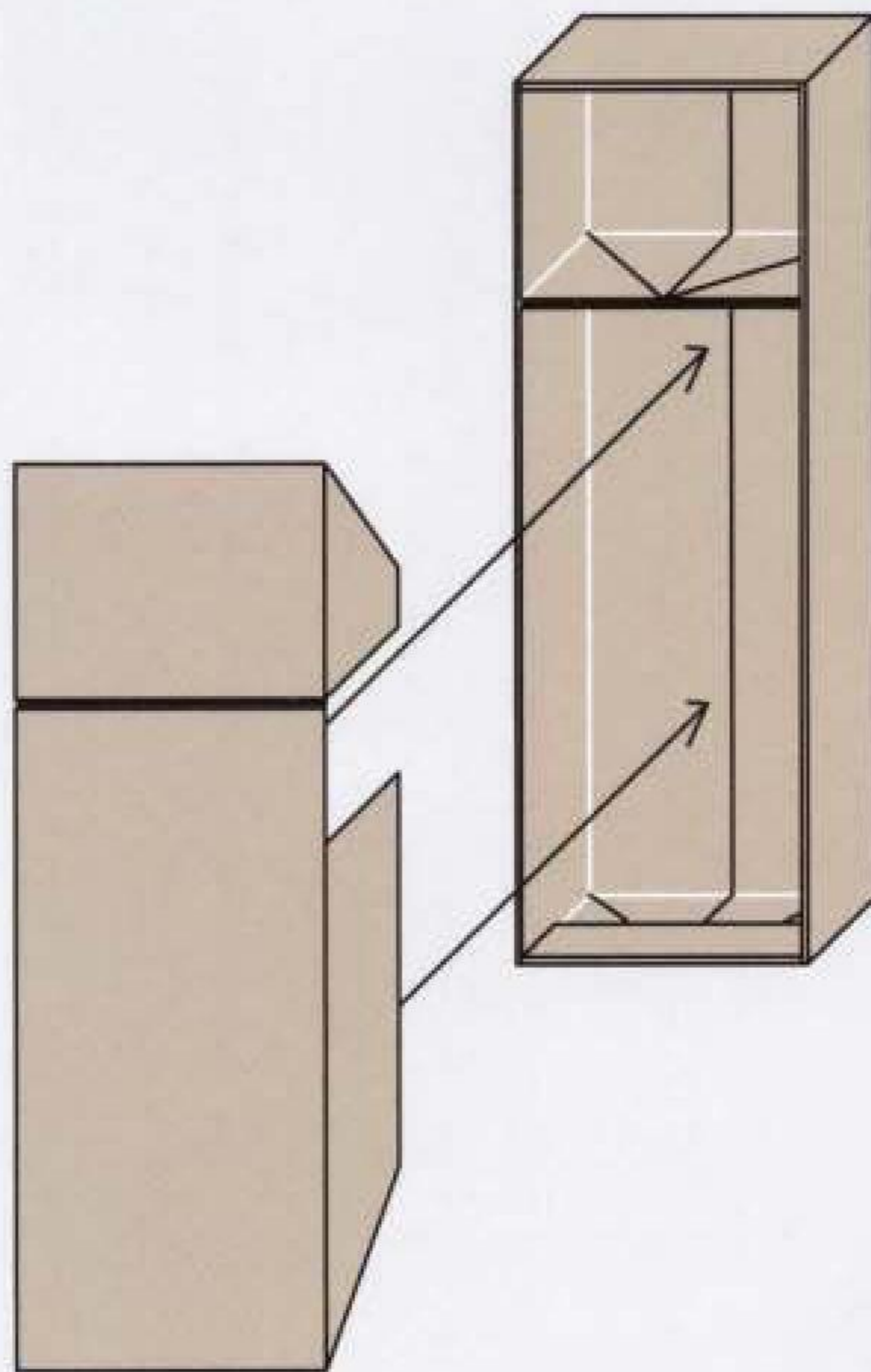

1. Join all parts together and apply glue

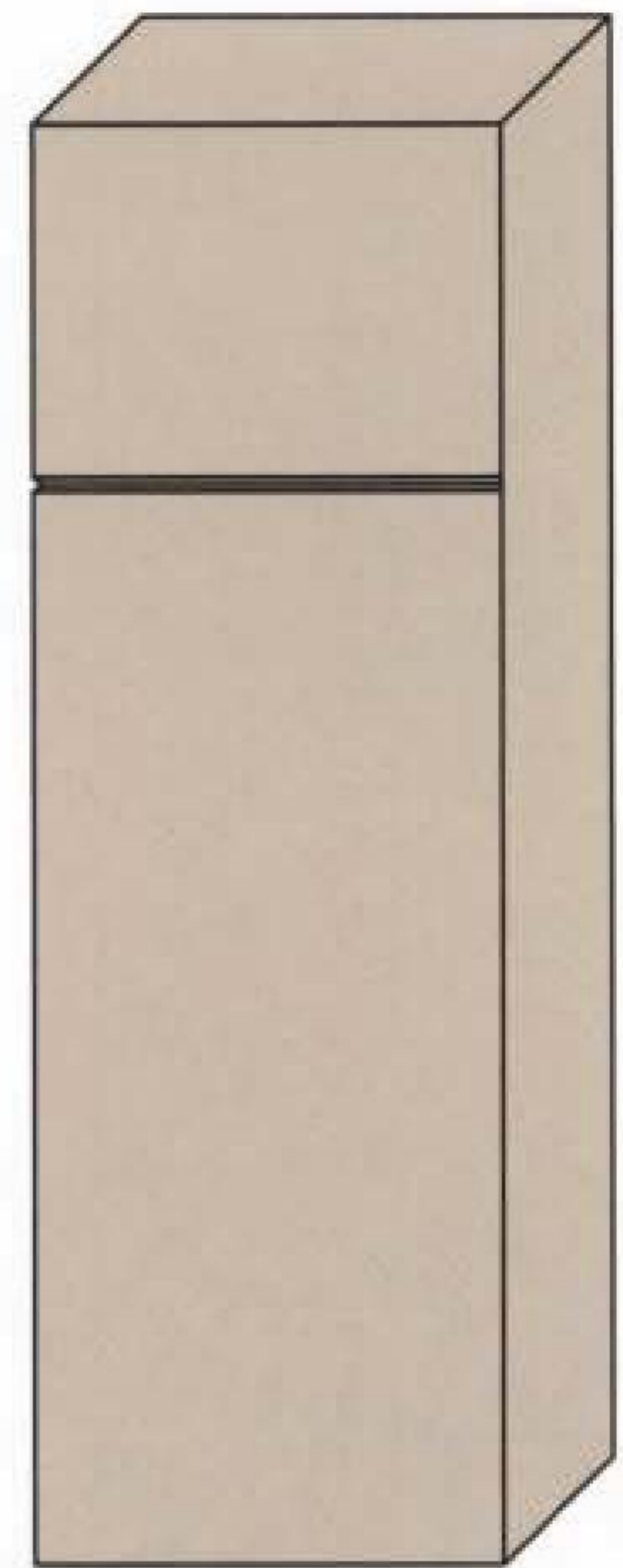

2. Completed REFRIGERATOR



4

office



*office chair | bookcase | computer | floor lamp
lounge chair | computer desk*

➤ office chair: part 1

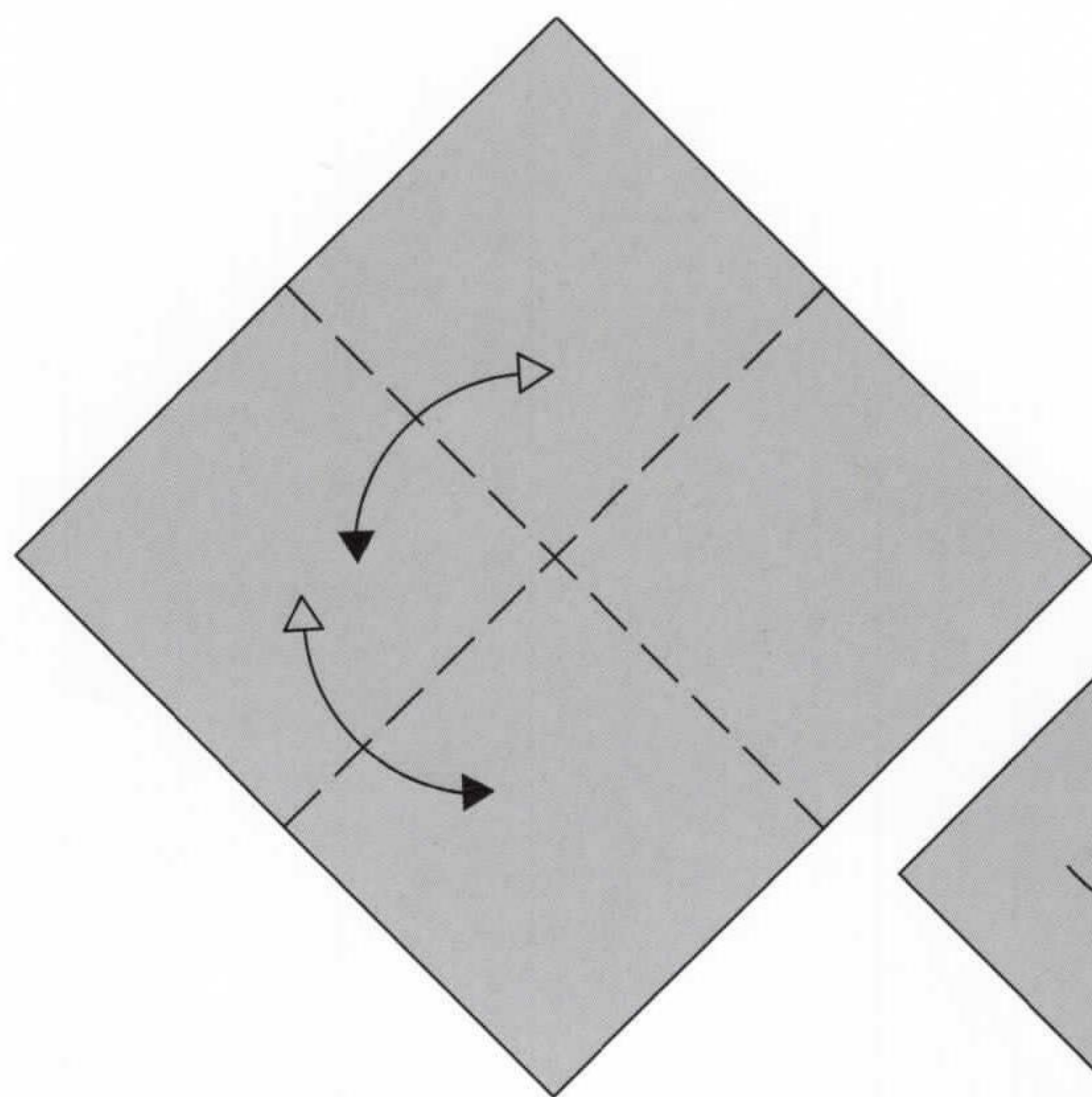

1. Use 4"x4" square.
Fold and unfold

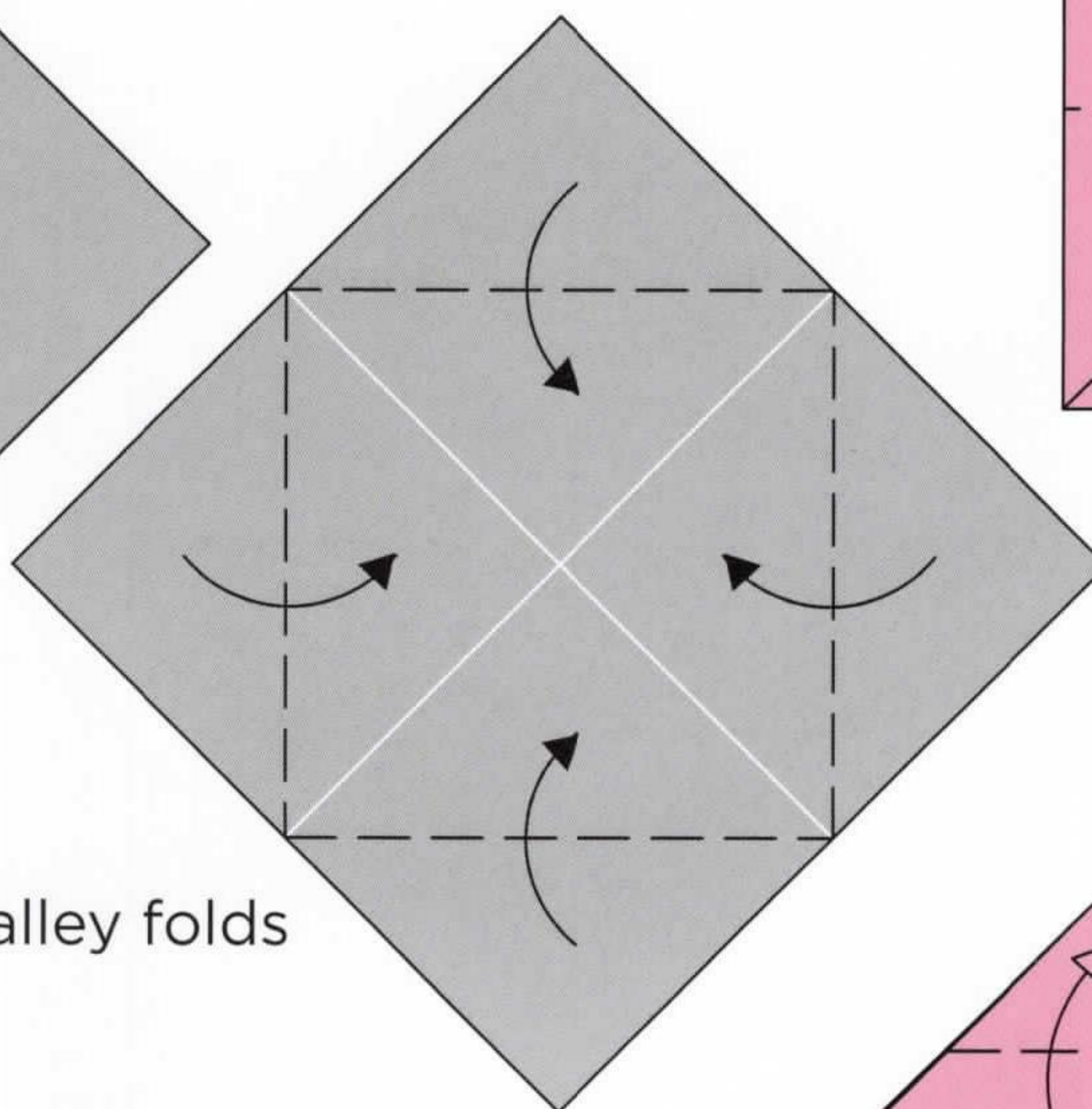

2. Valley folds

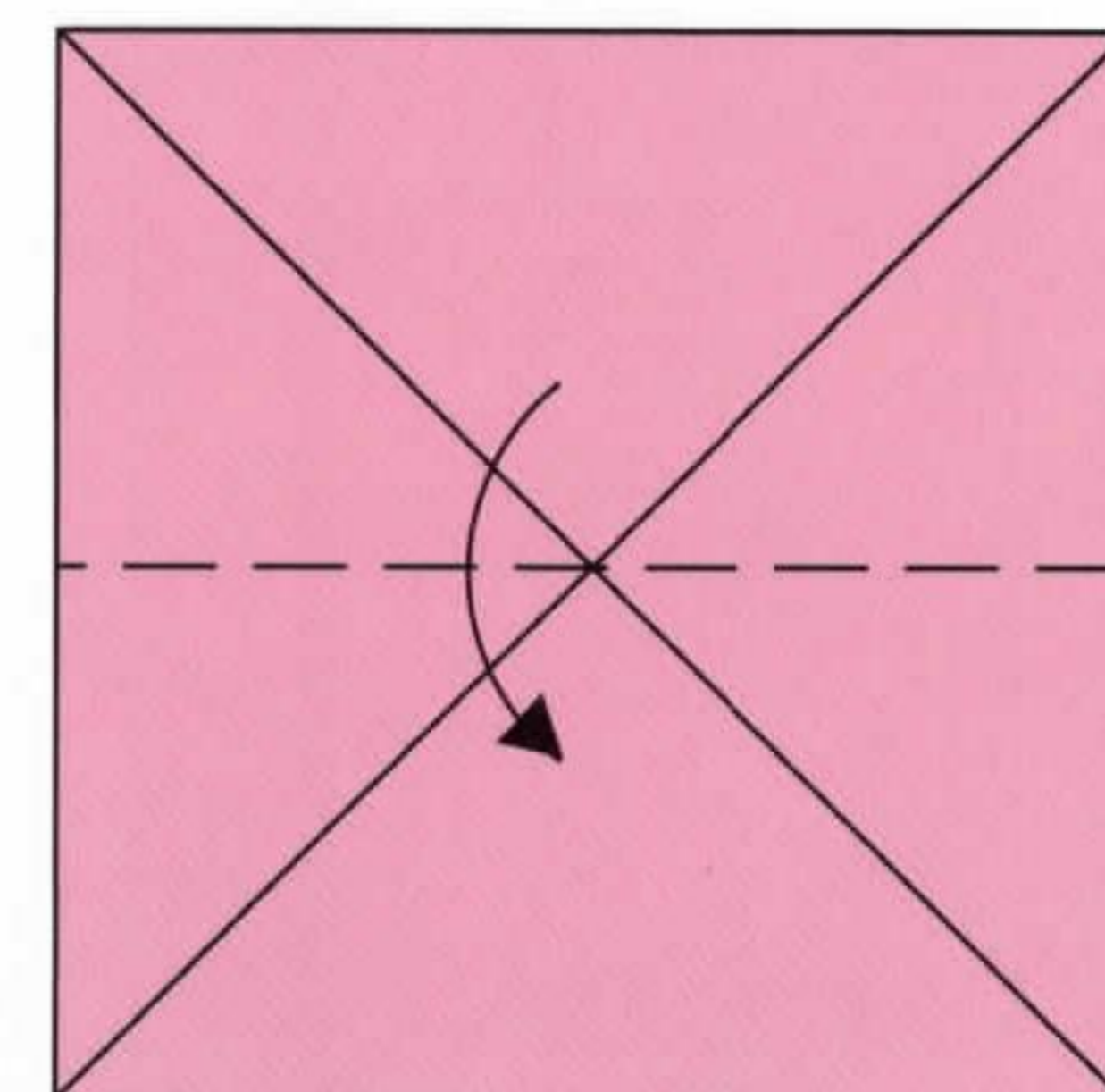

3. Valley fold

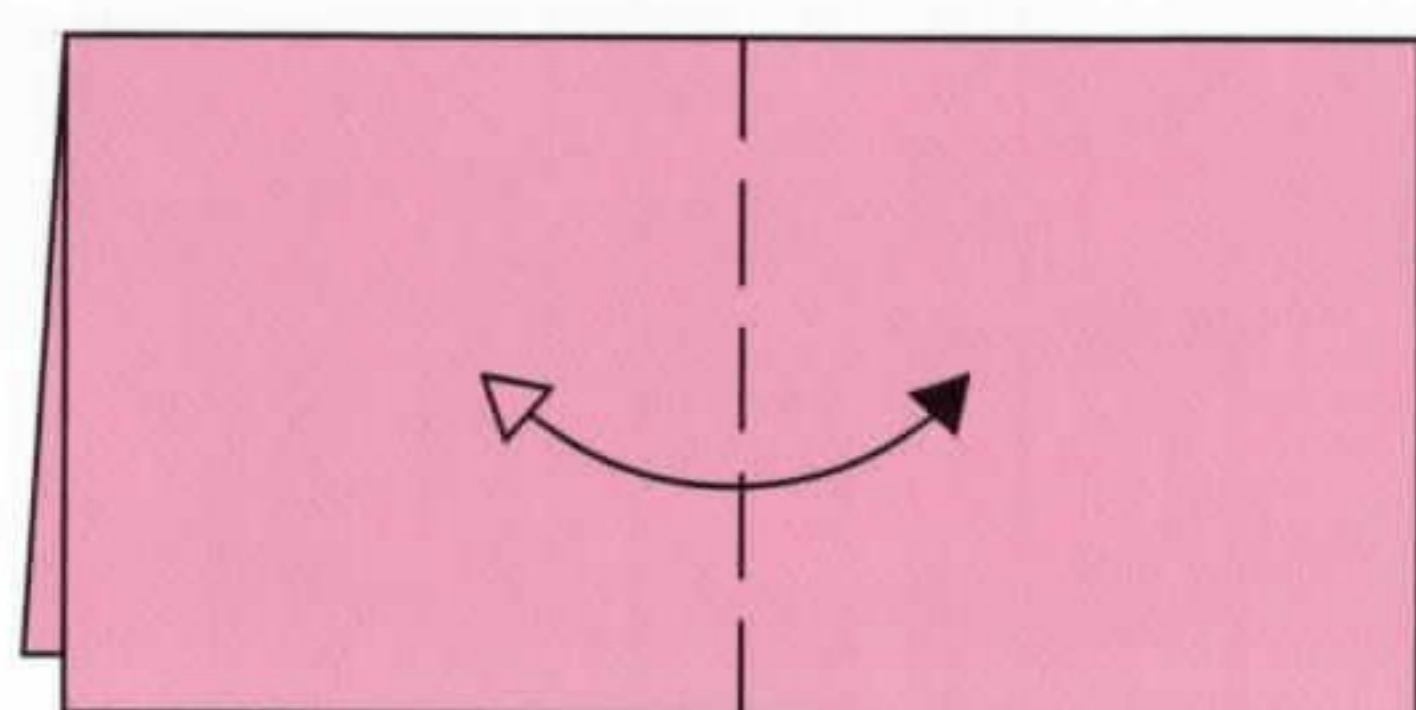

4. Valley fold
and unfold

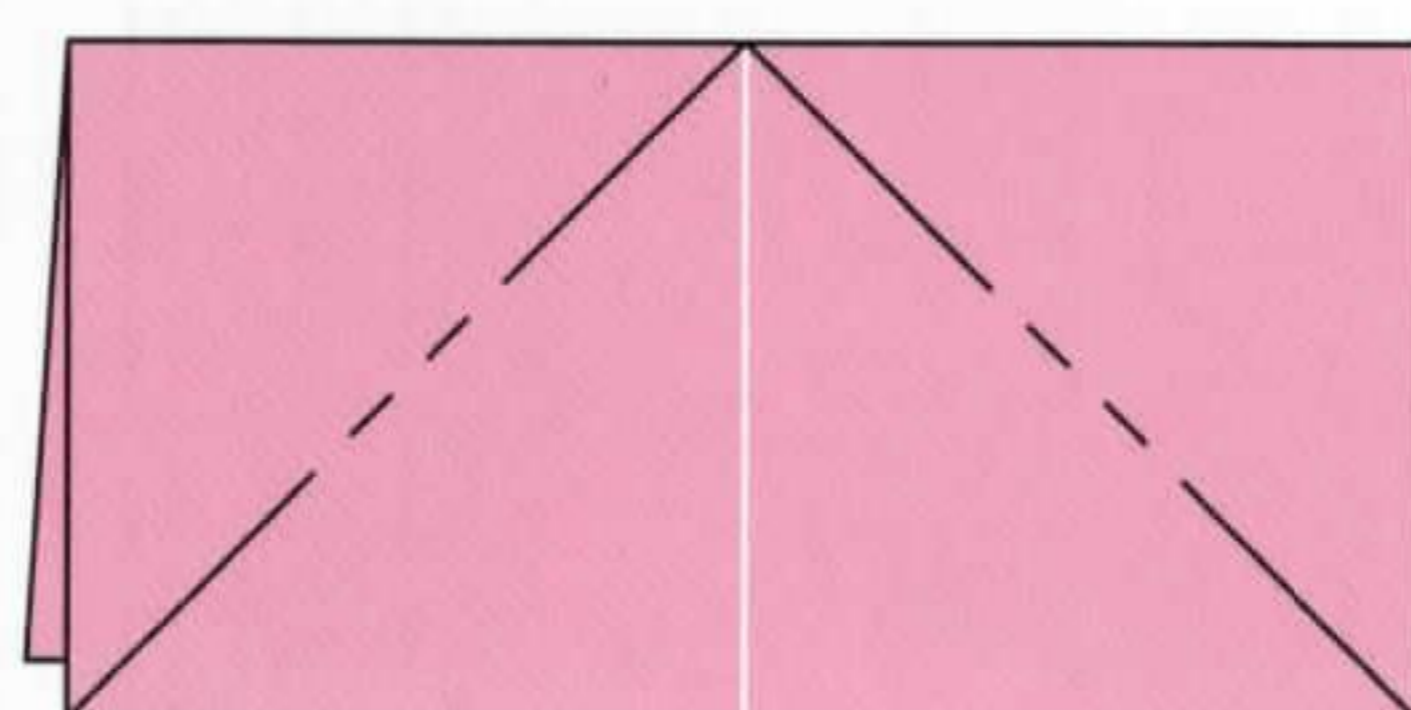

5. Inside reverse
folds

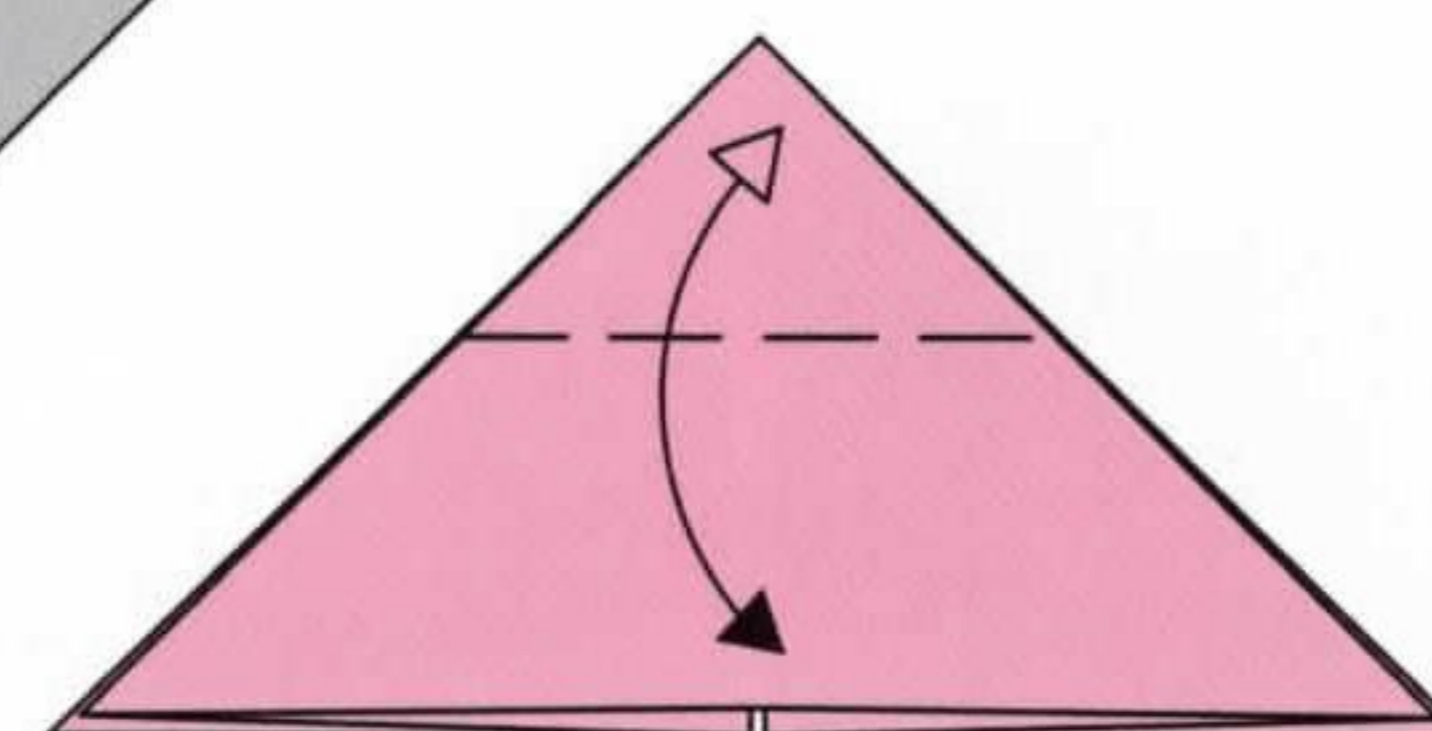

6. Valley fold
and unfold

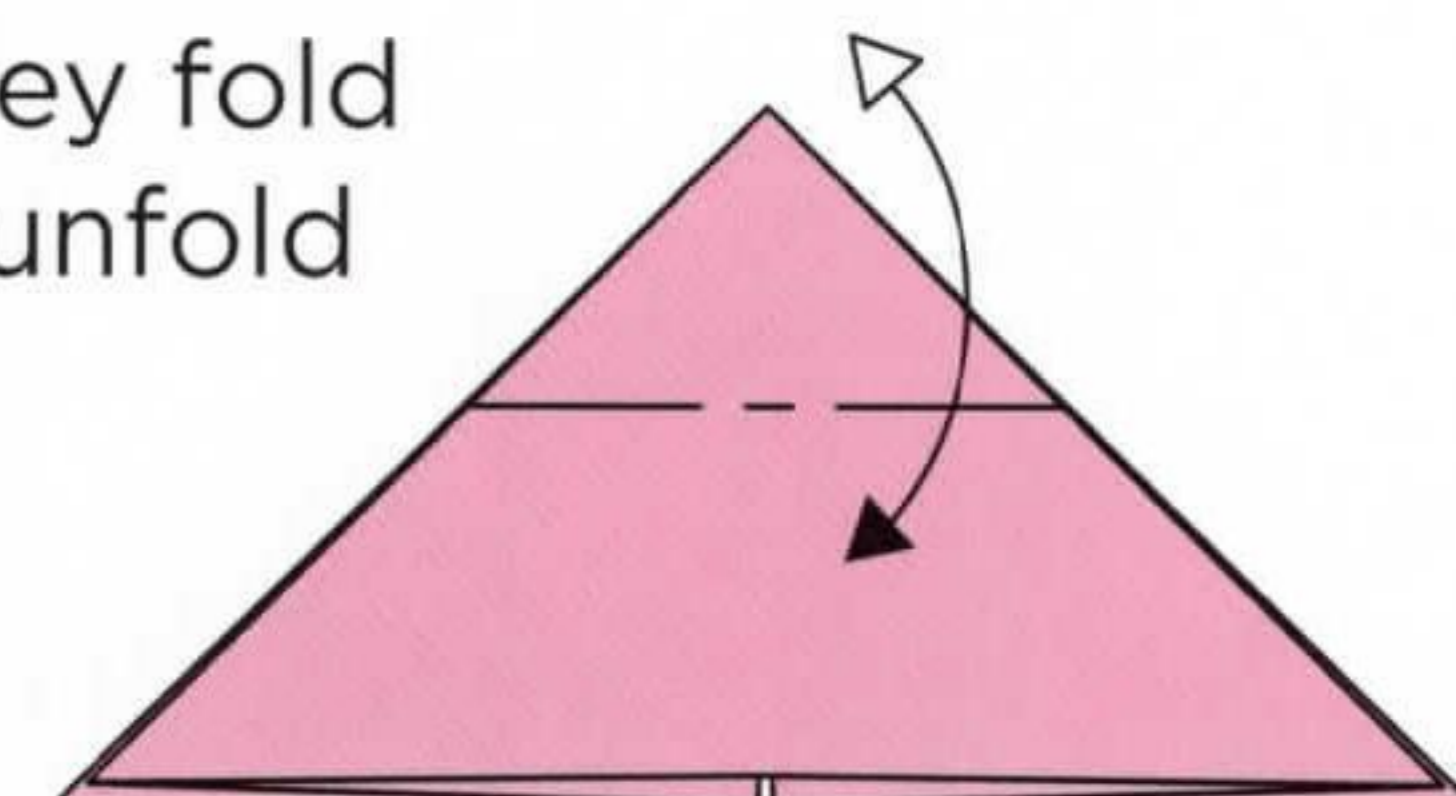

7. Mountain fold
and unfold

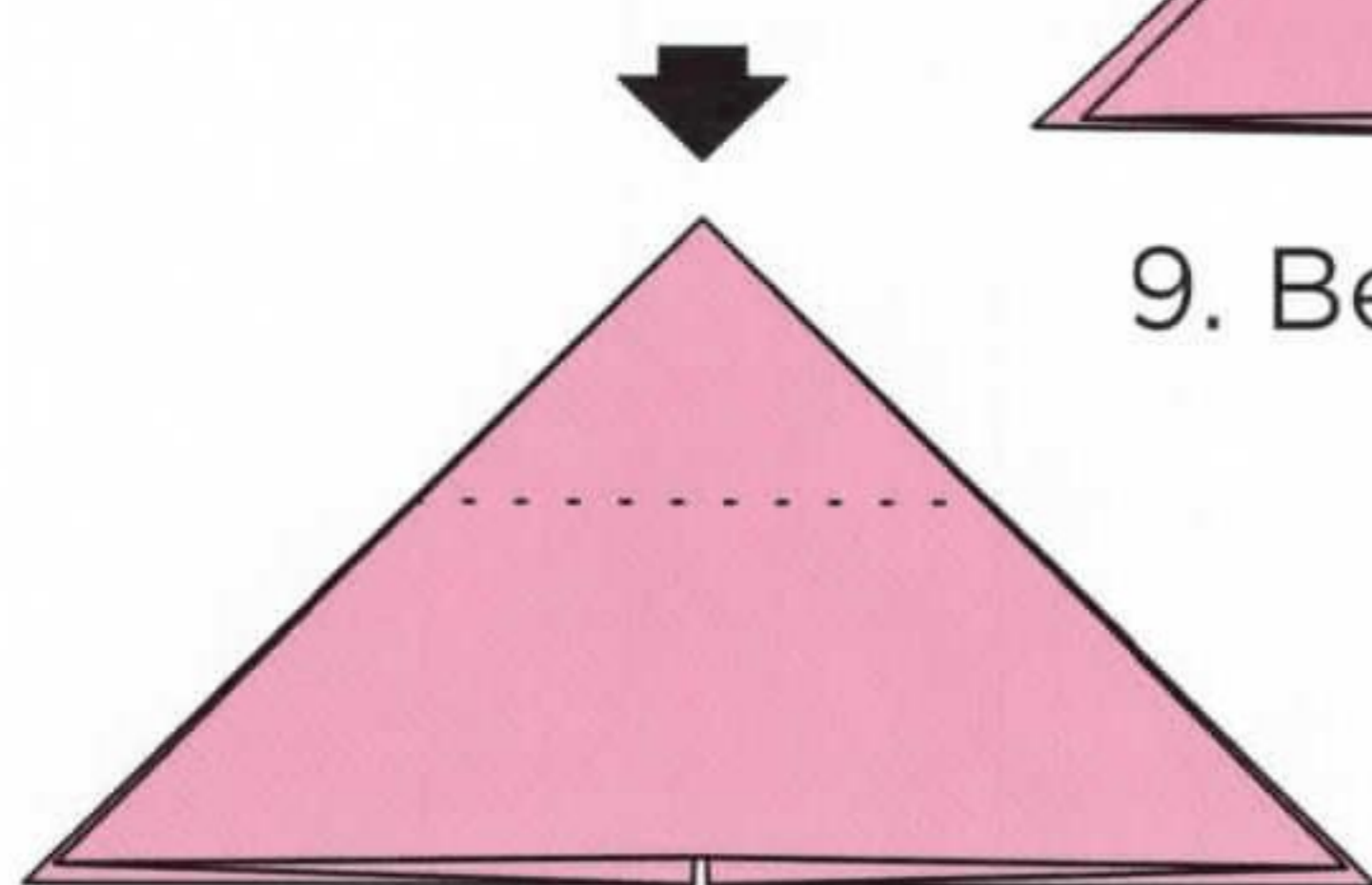

8. Push down
as a sink fold

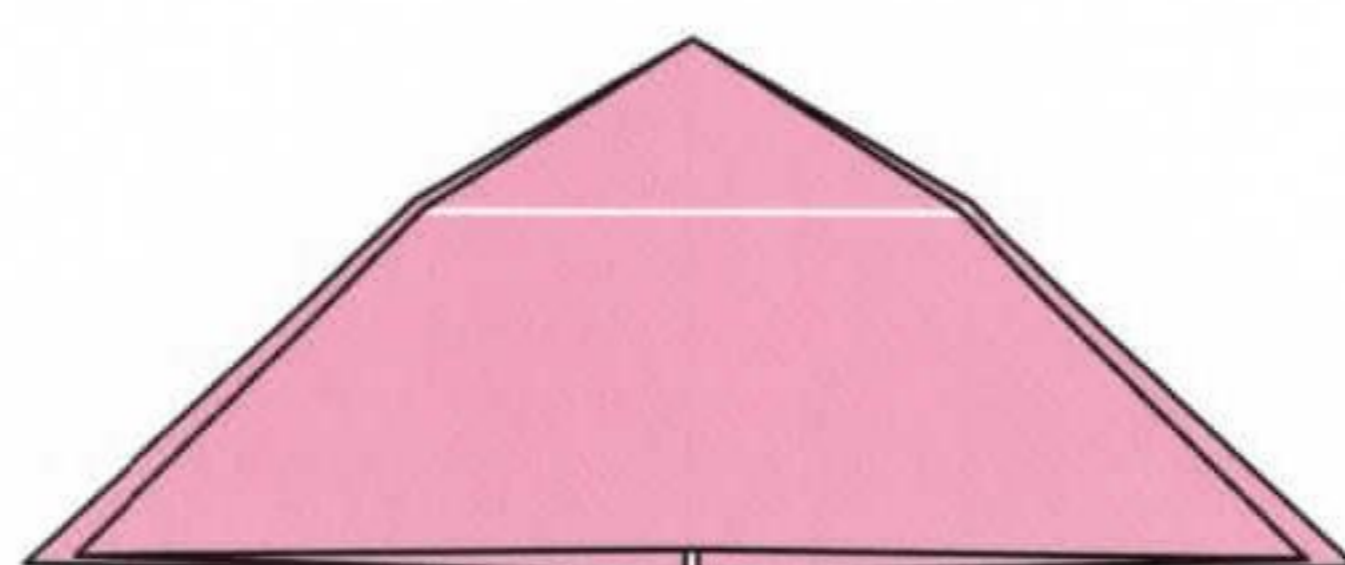

9. Before complete

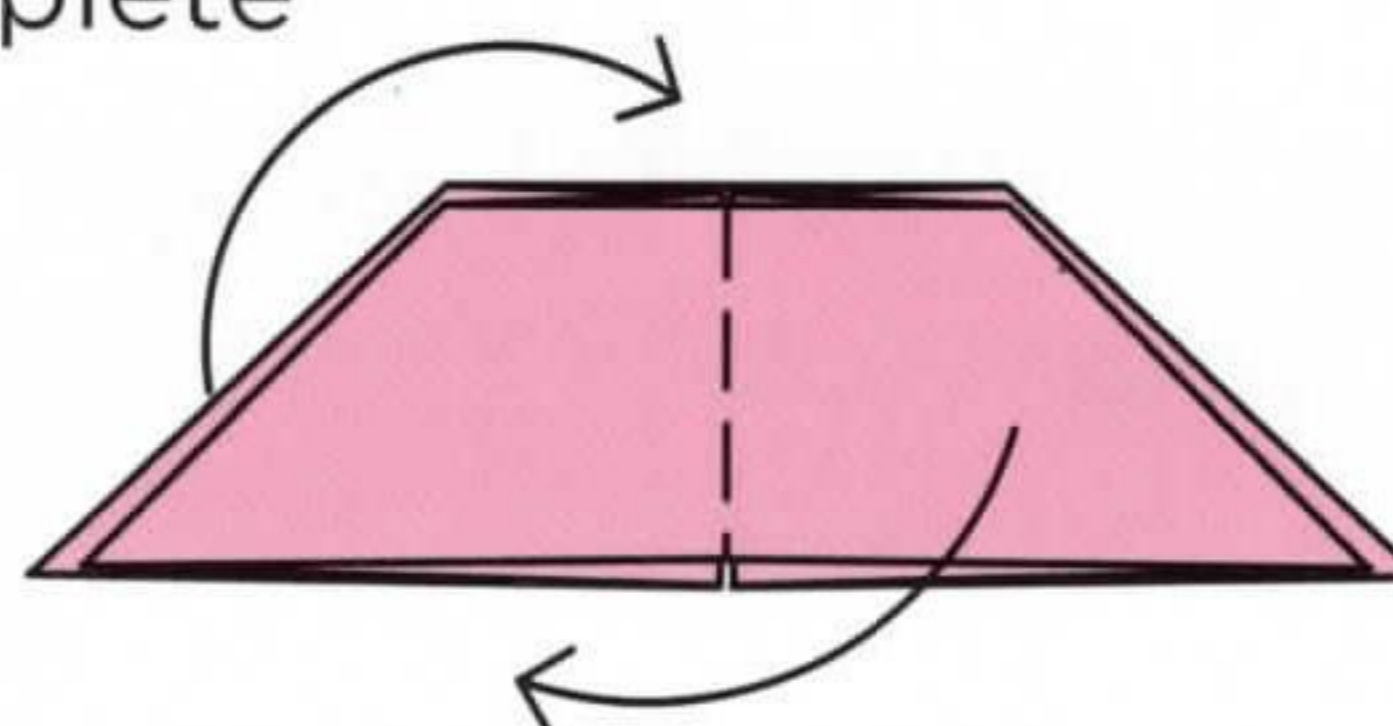

10. Separate all four legs

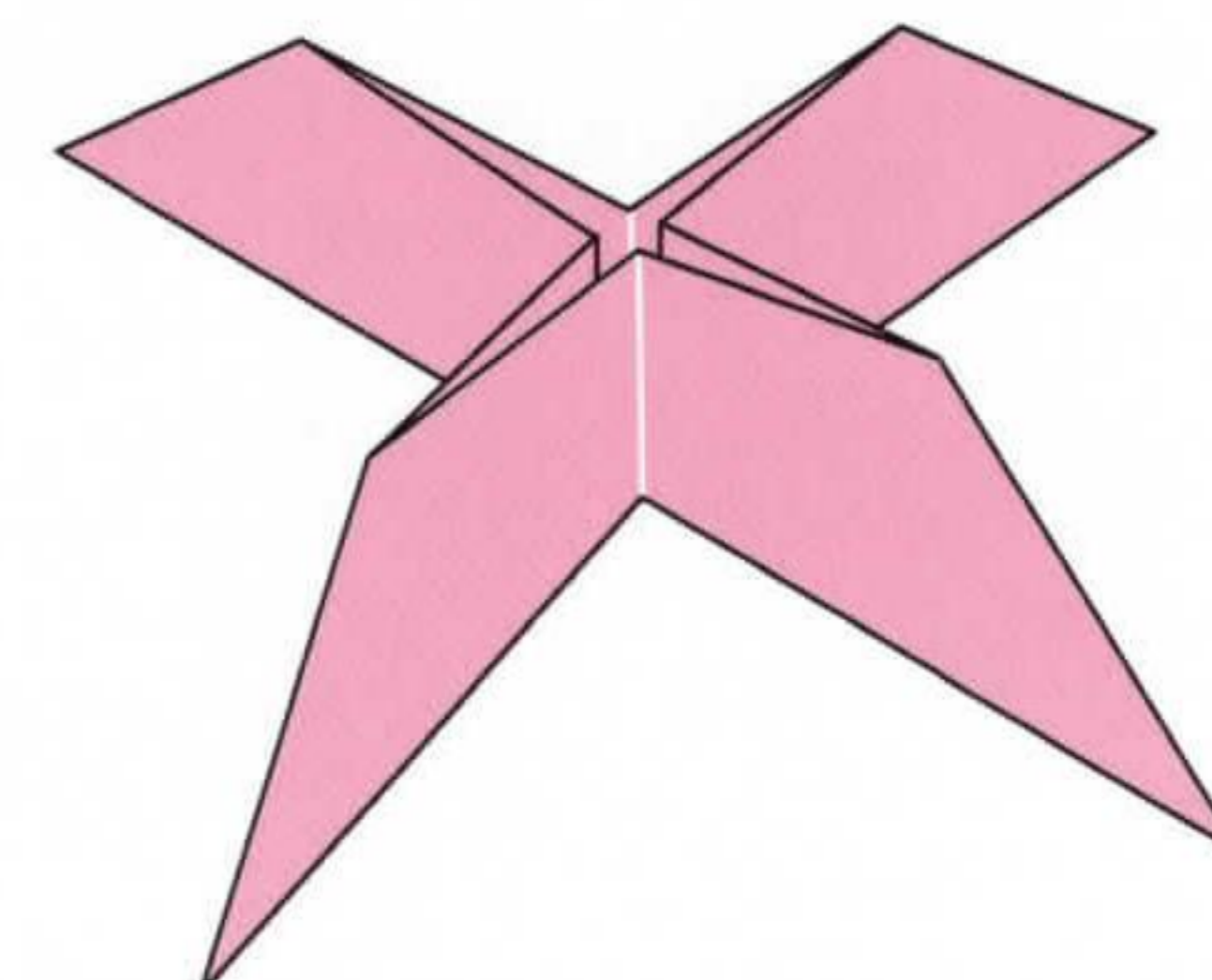

11. Completed PART 1

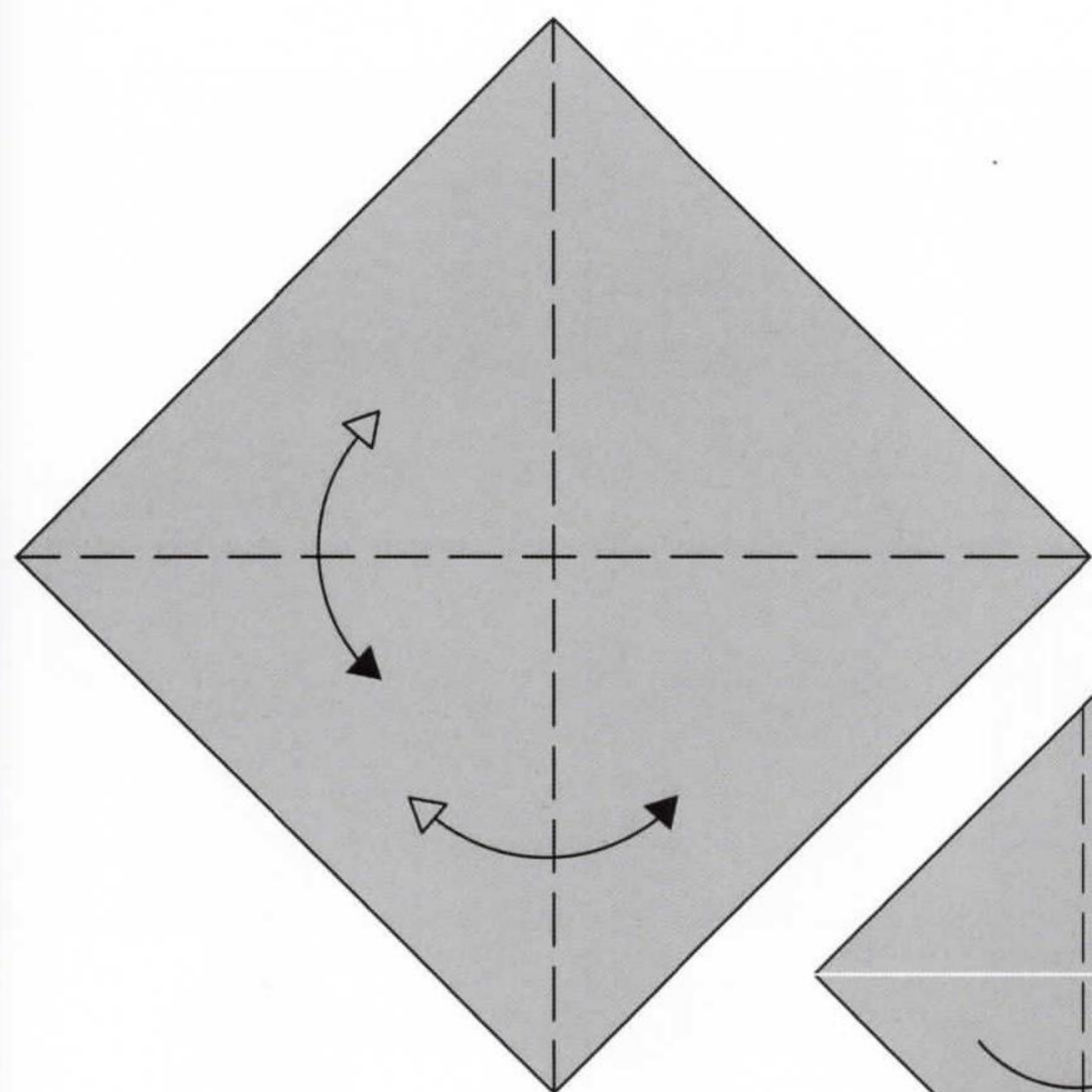

1. Valley folds and unfold

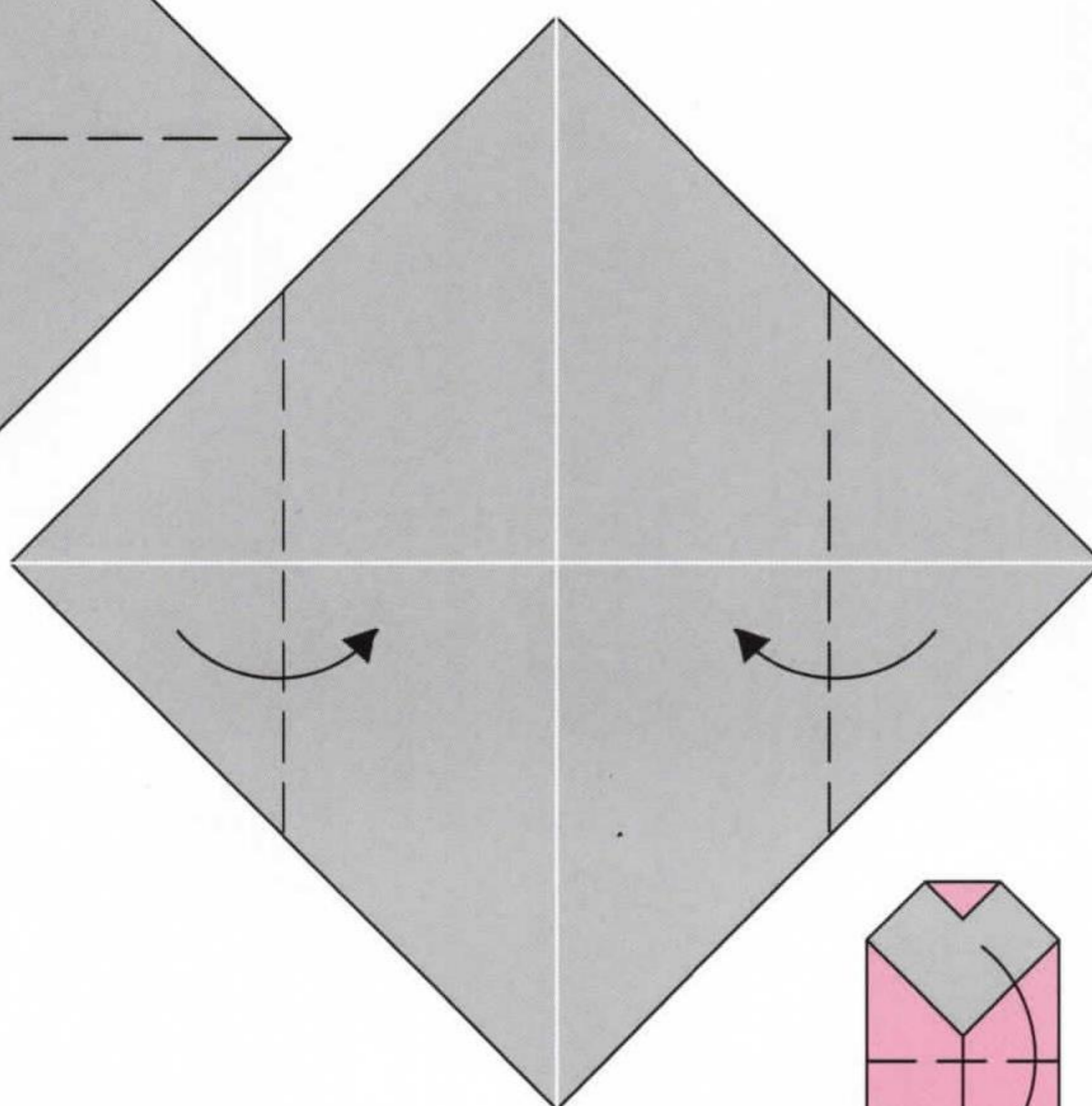

2. Valley folds

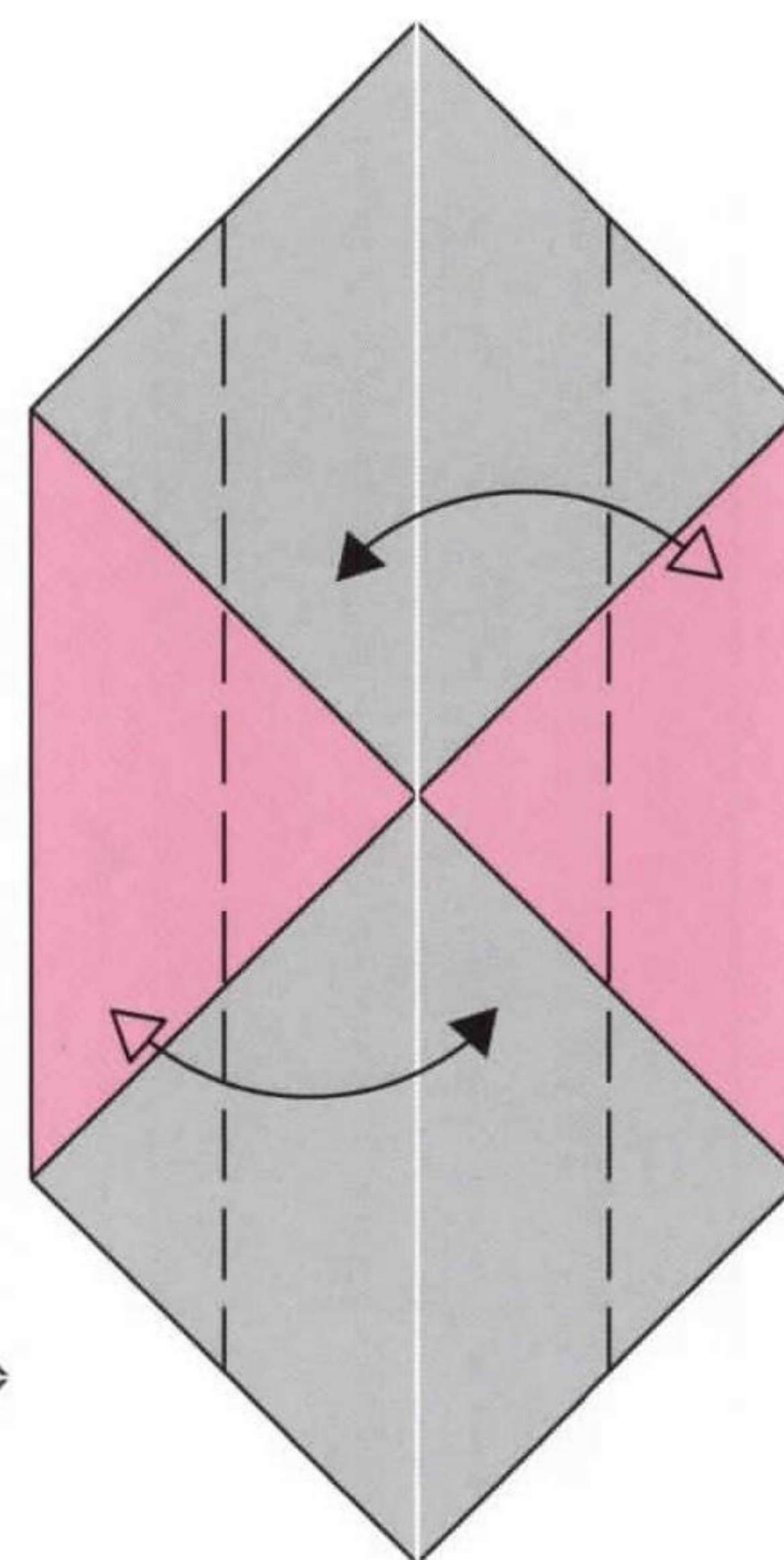

3. Valley folds and unfold

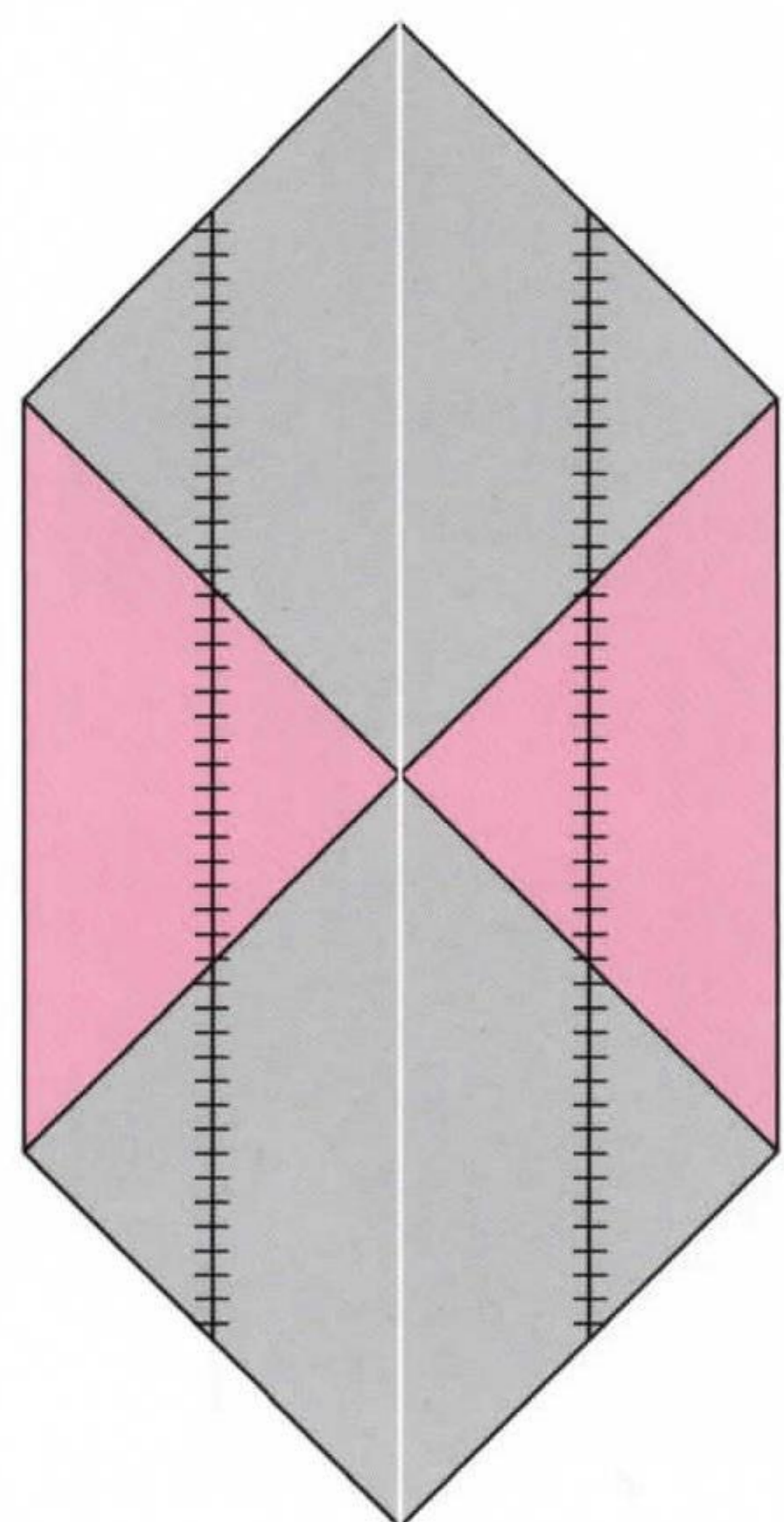

4. Cuts as shown

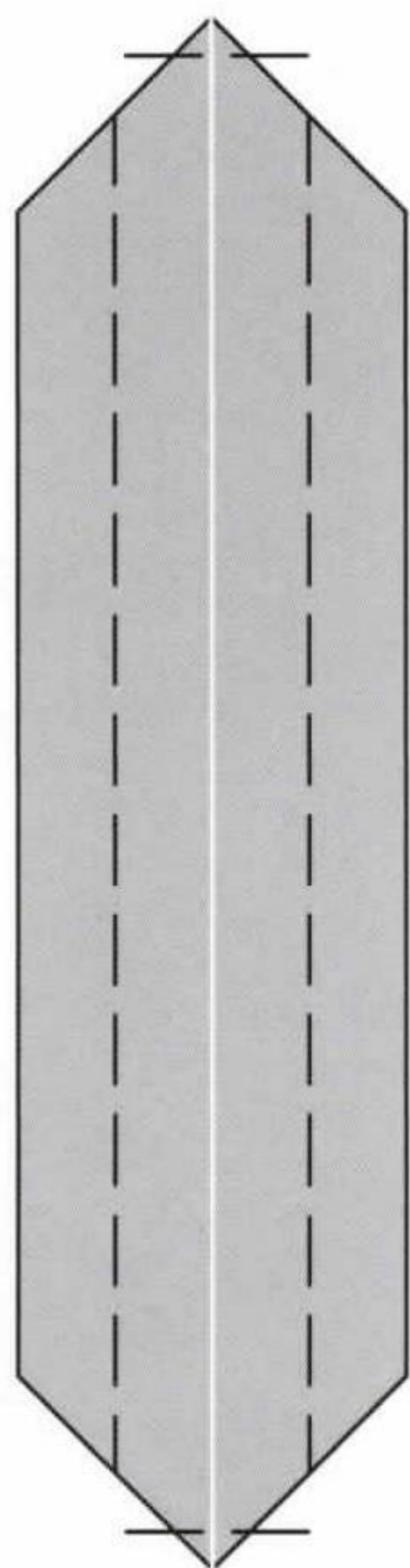

5. Valley folds and scale-up



6. Valley folds

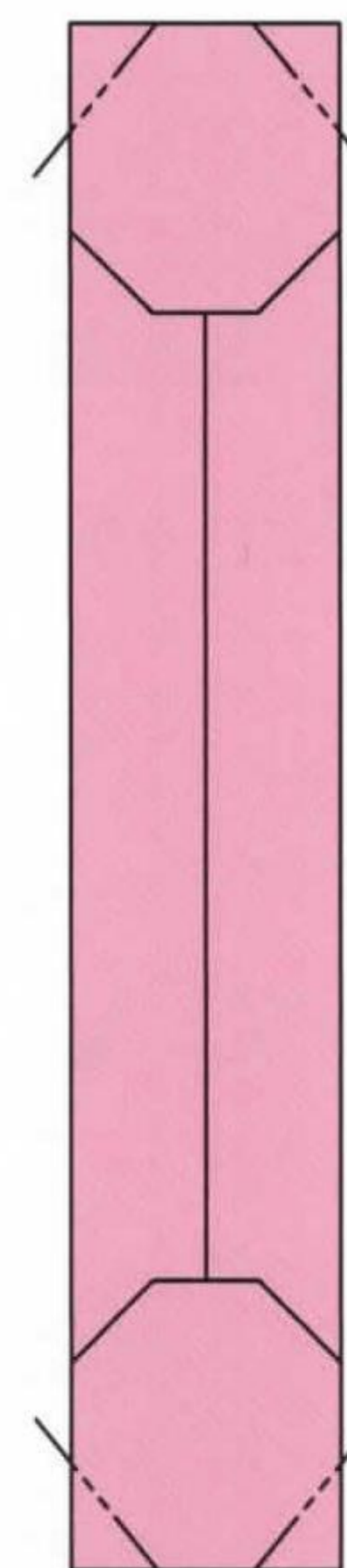

7. Inside reverse folds

office chair: part 2

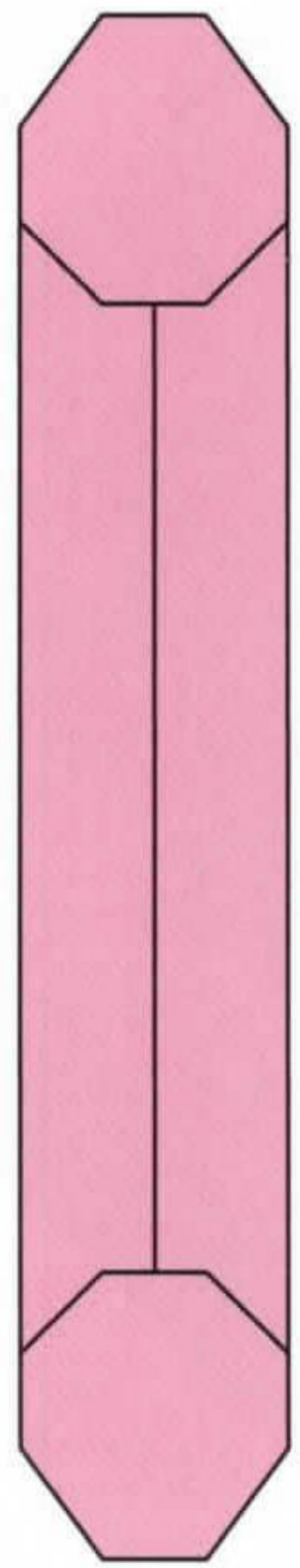

8. Turn over

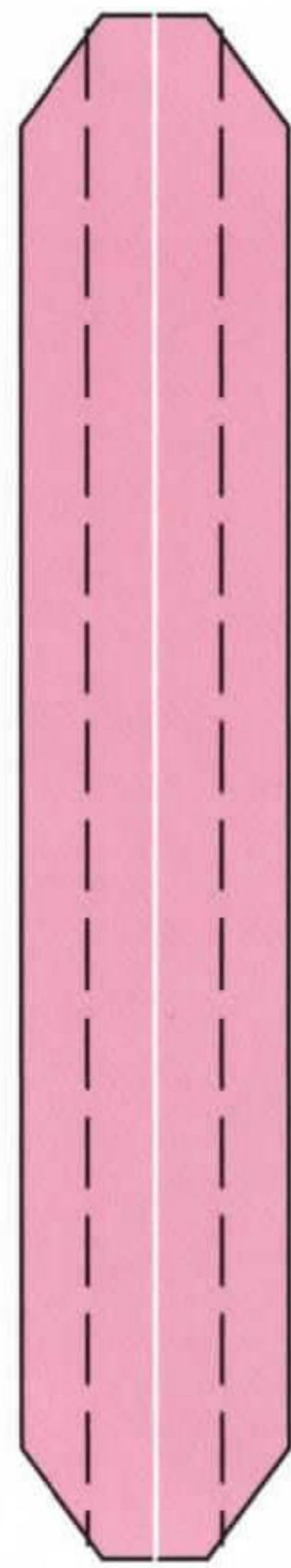
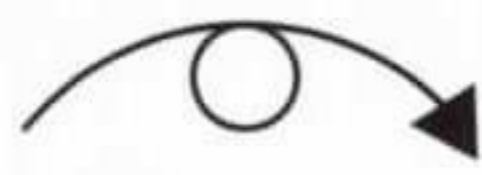

9. Valley folds

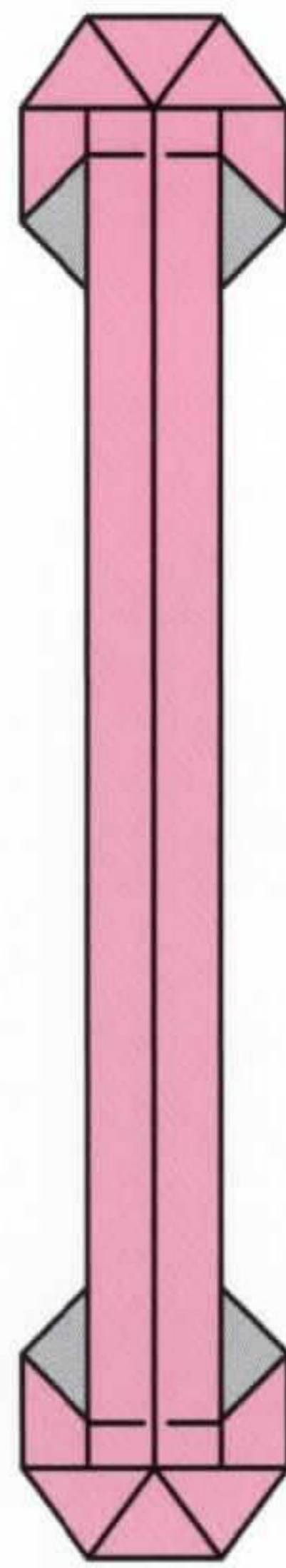

10. Valley fold

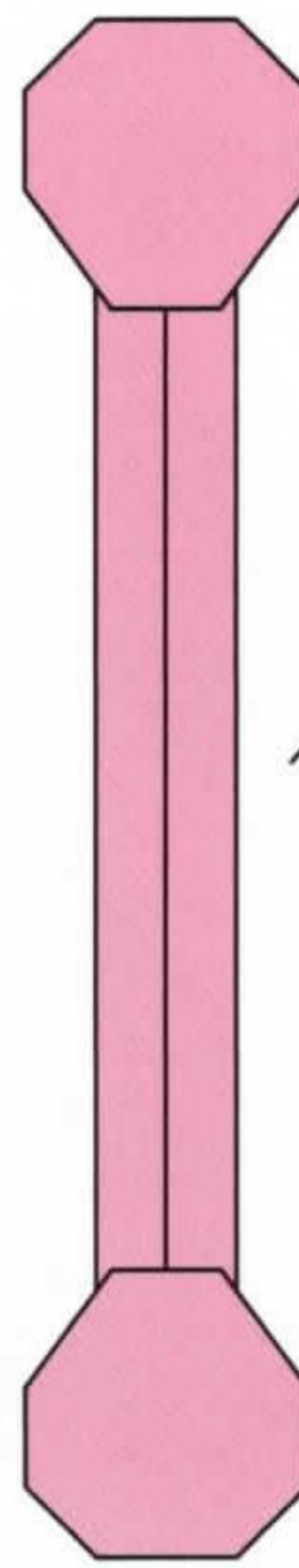

11. Turn over

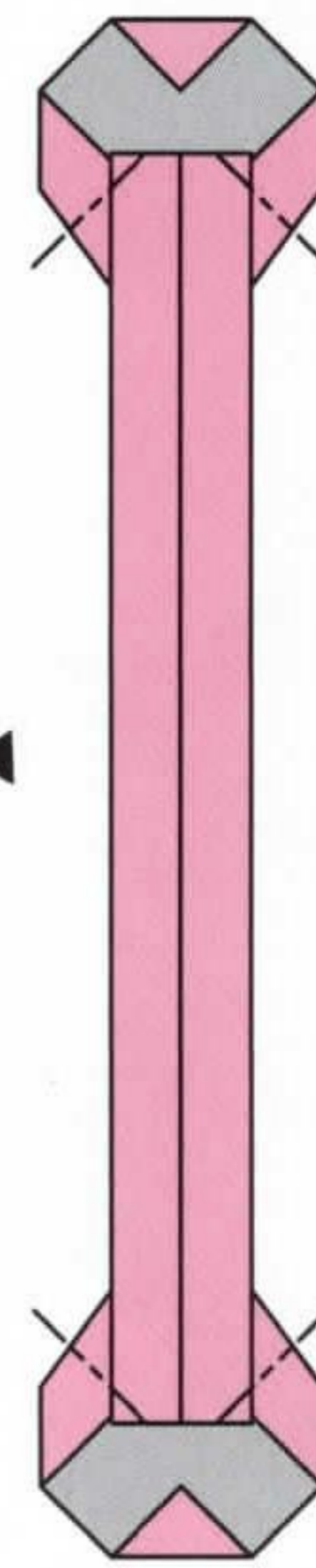

12. Inside reverse folds

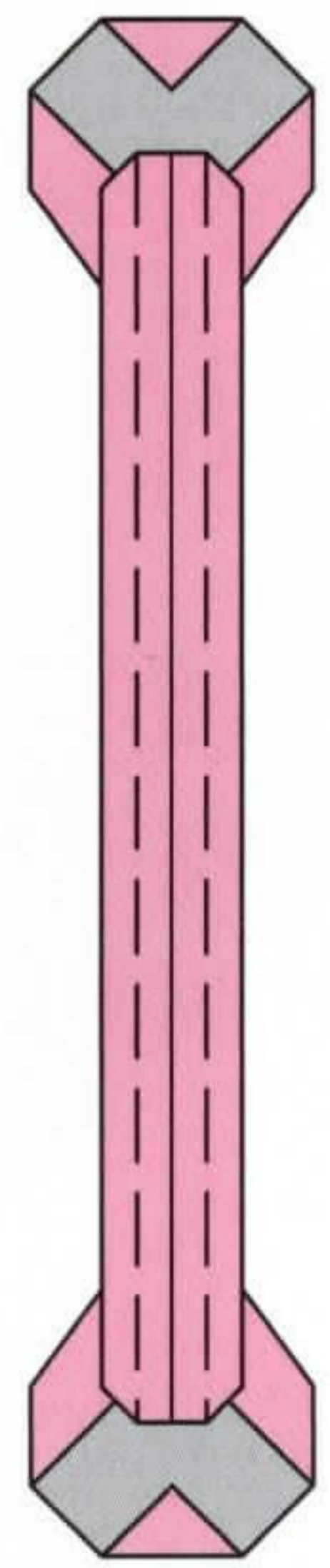

13. Valley folds

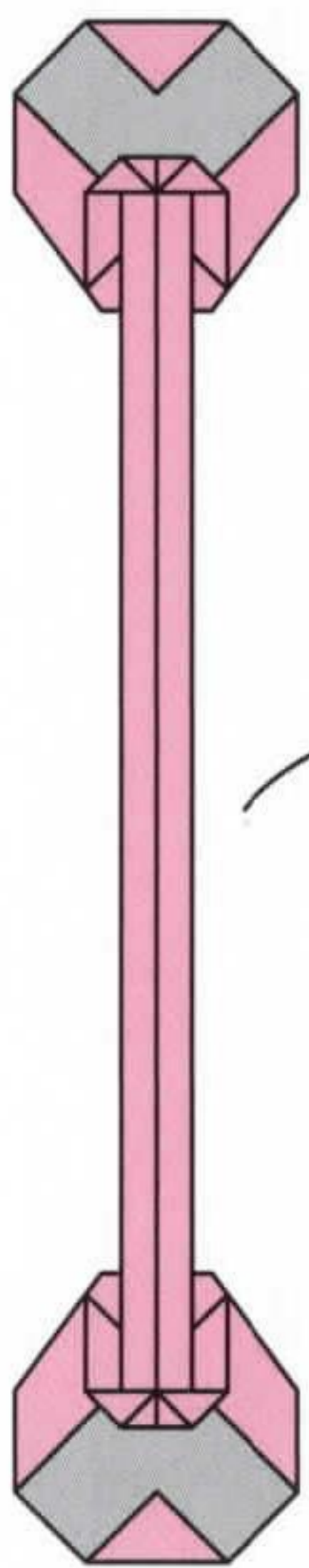

14. Rotate

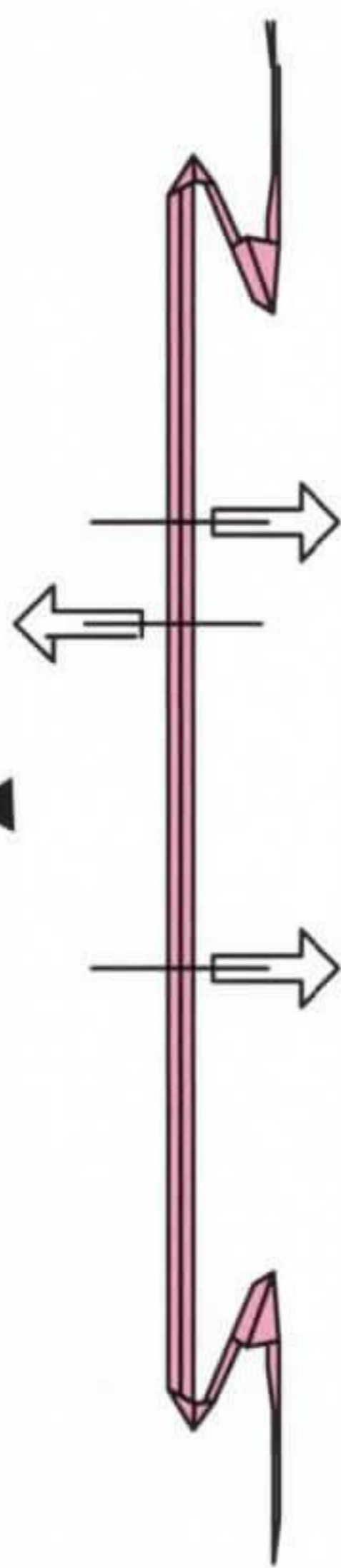

15. Bend as shown

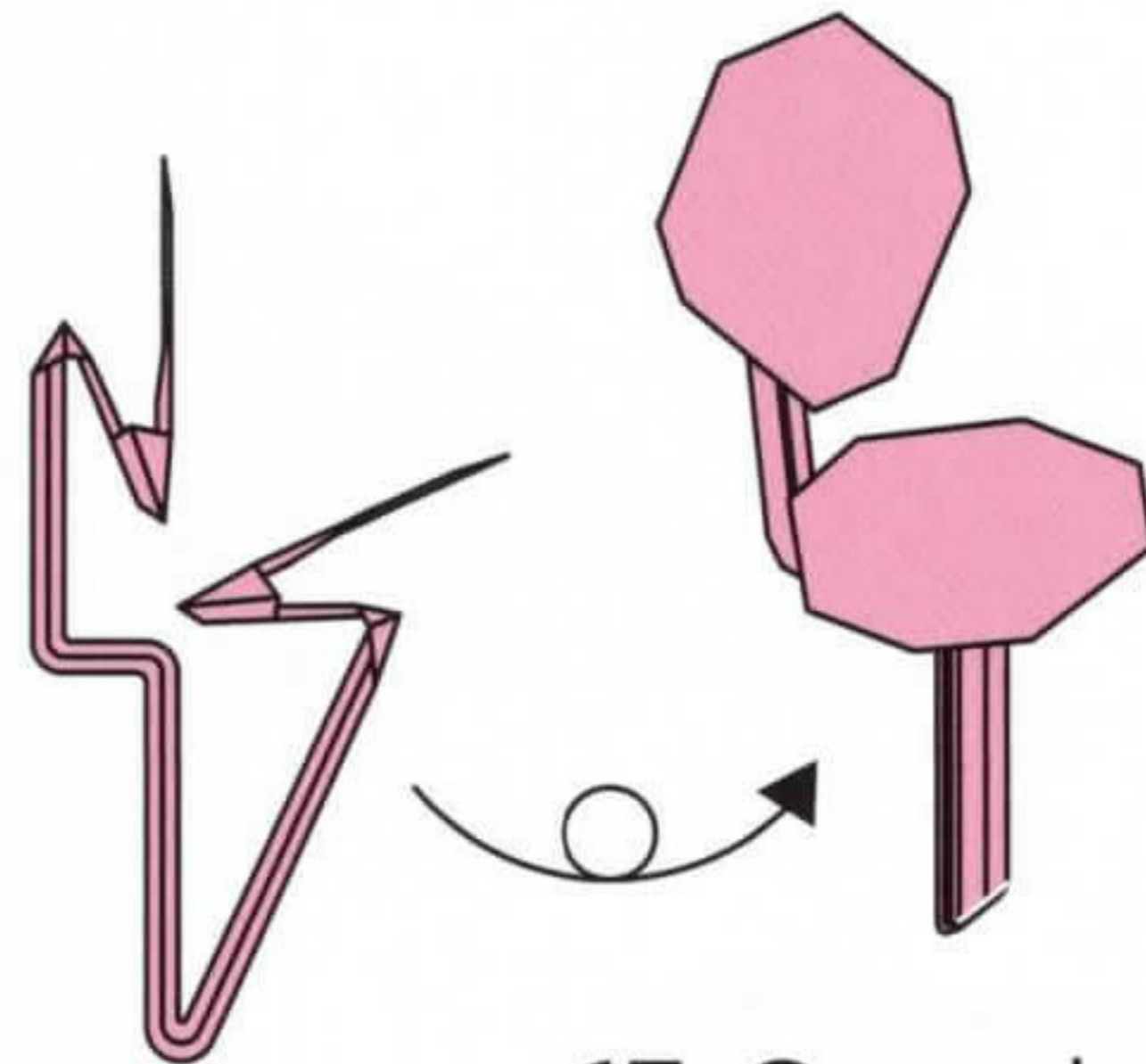

16. Rotate

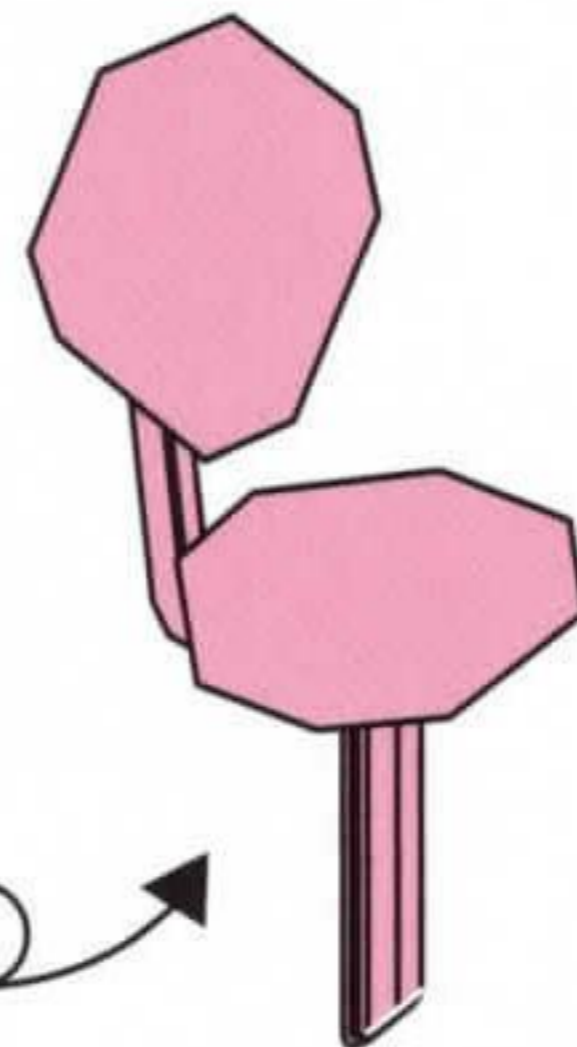

17. Completed PART 2

ASSEMBLY

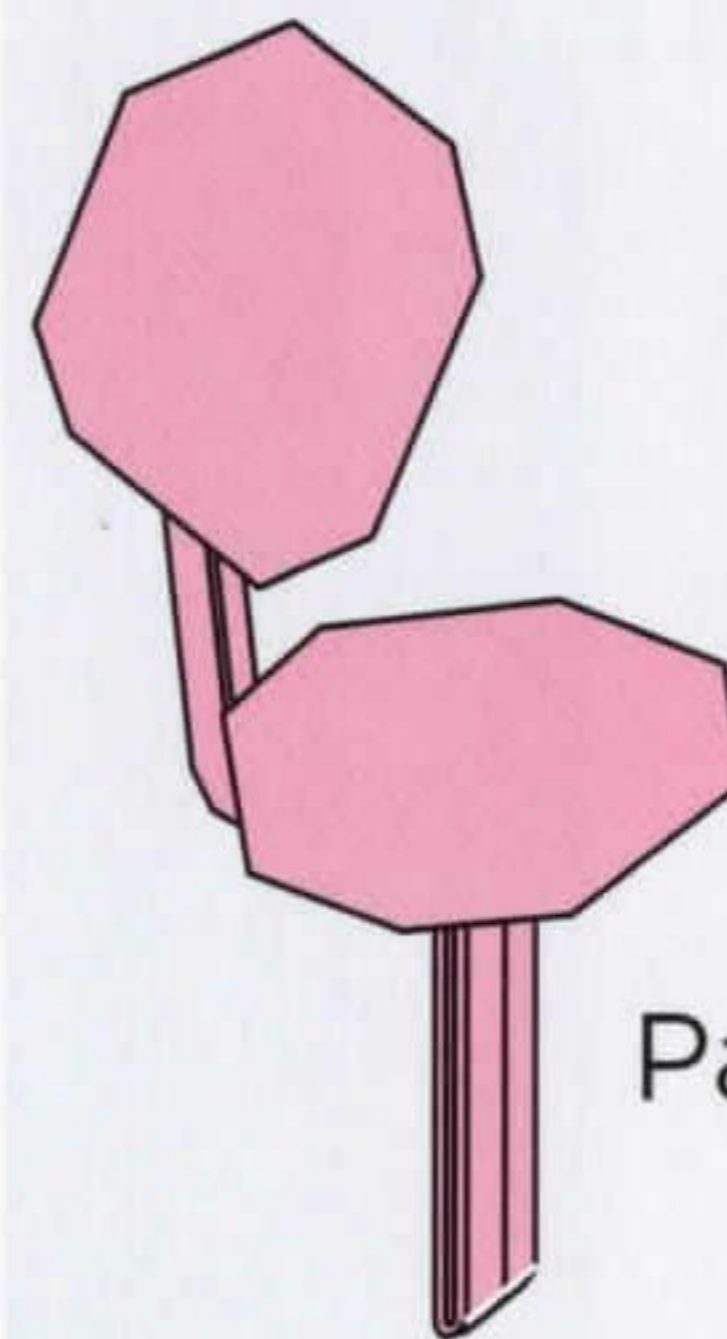

1. Insert and apply glue

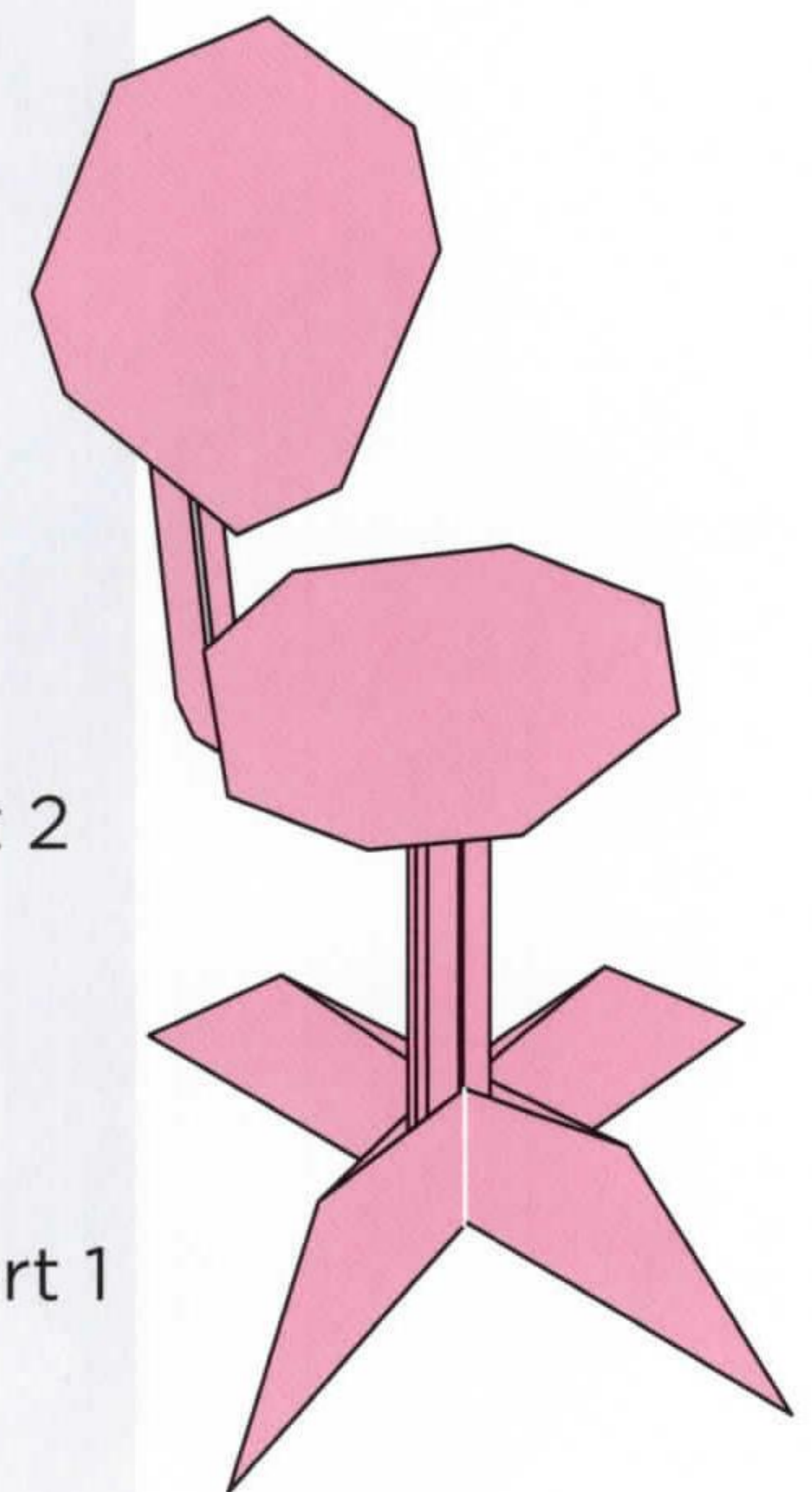

2. Completed OFFICE CHAIR

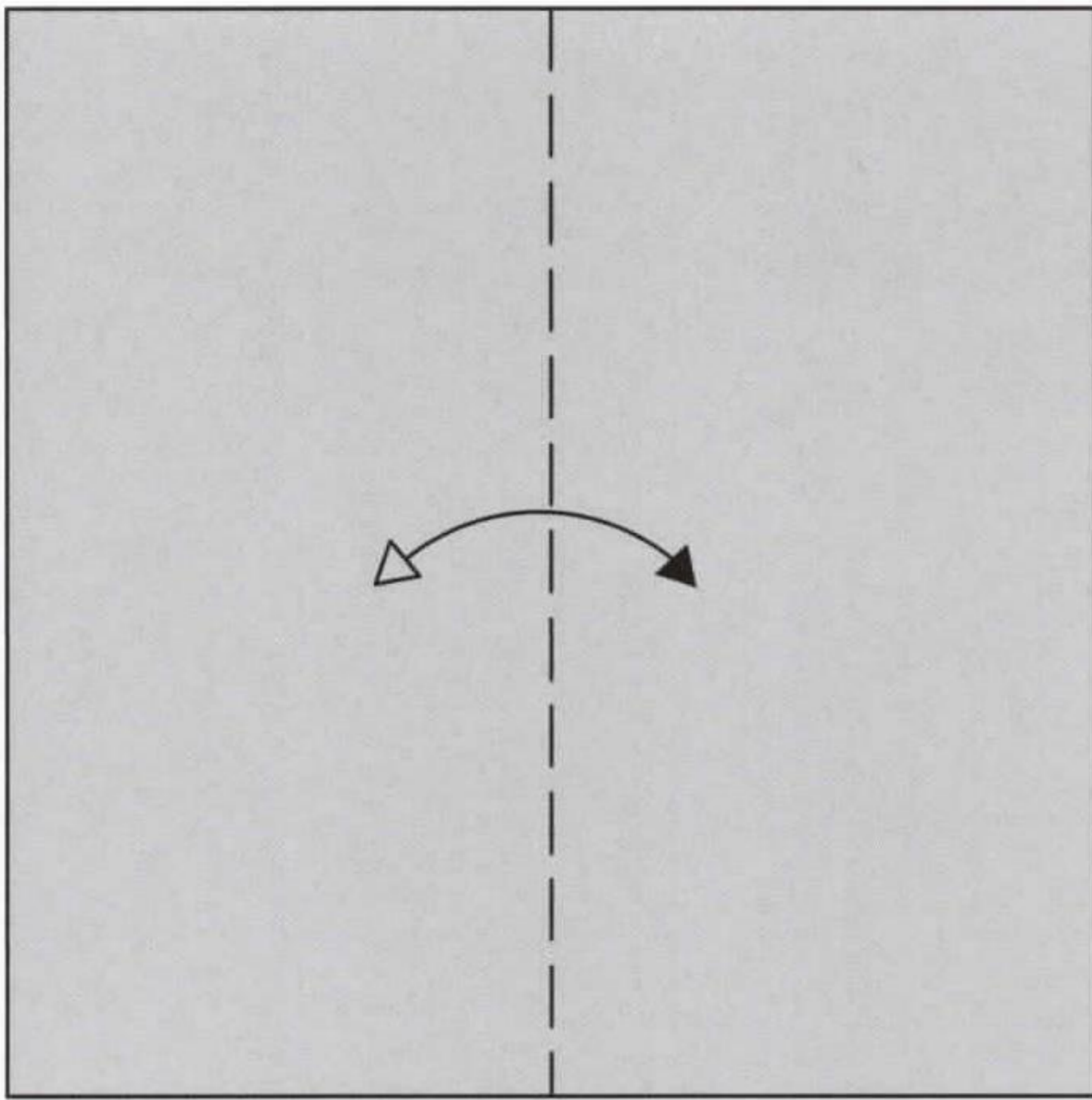

1. Valley fold and unfold

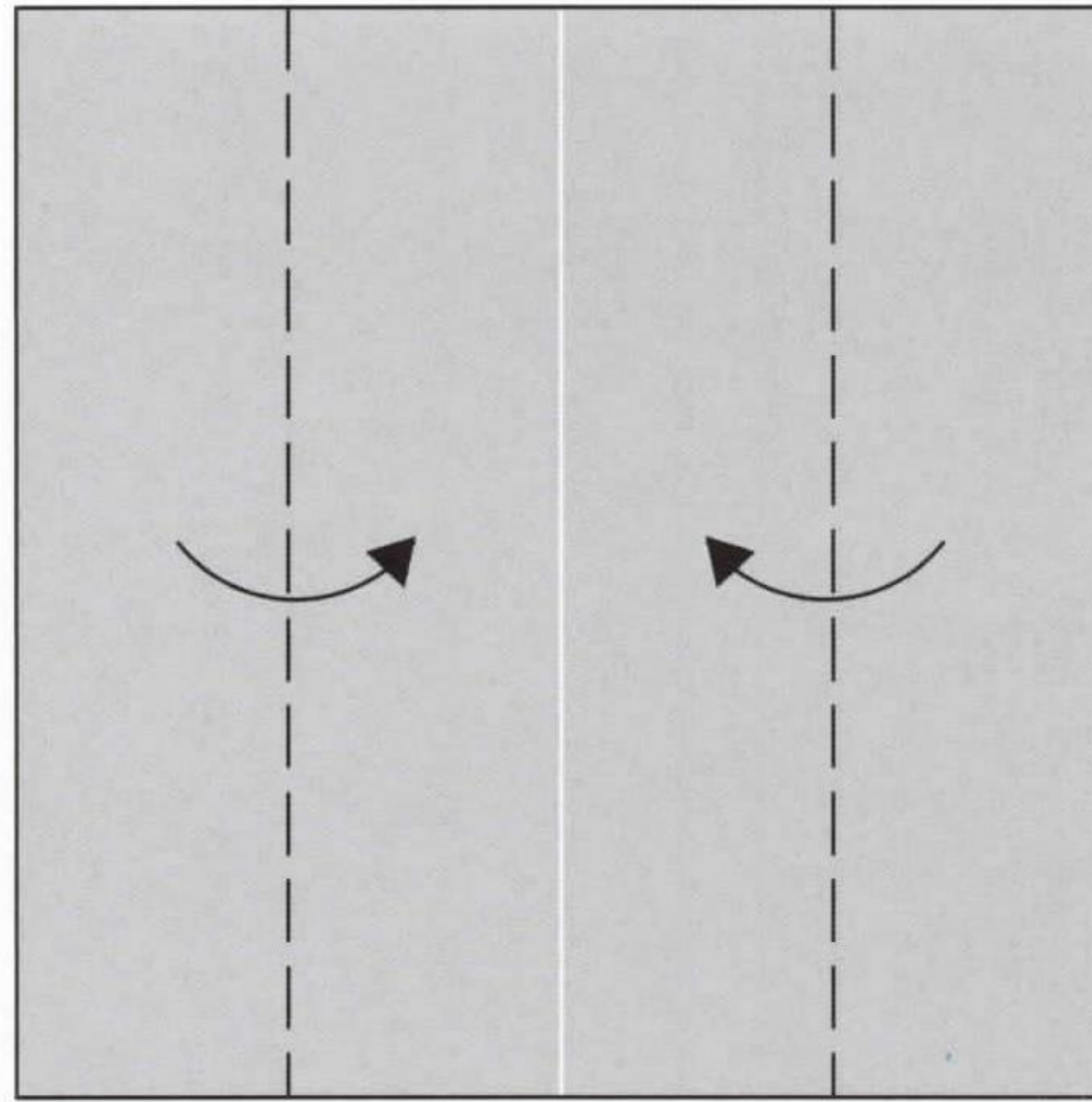

2. Valley folds

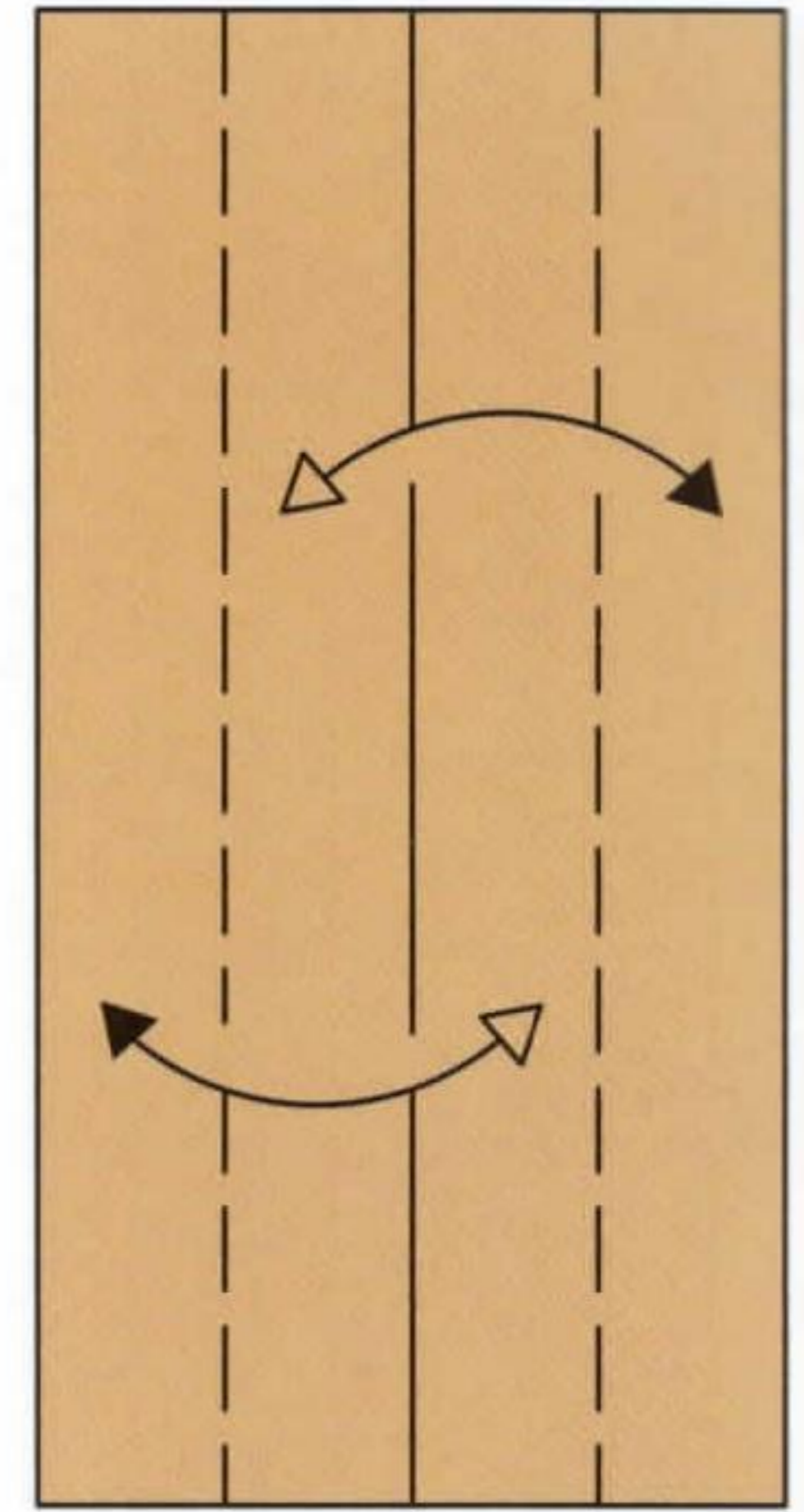

3. Valley folds and unfold

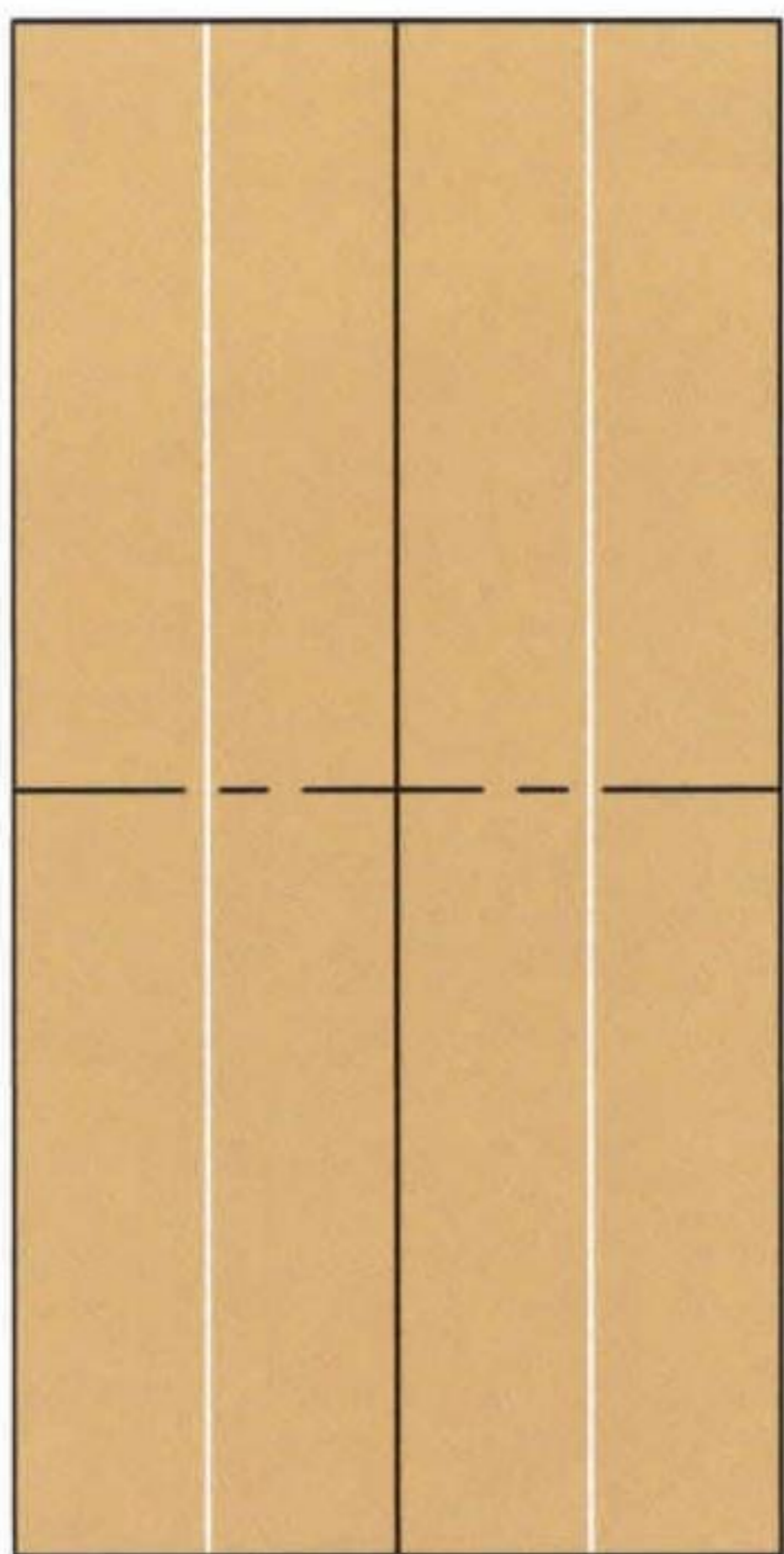

4. Mountain fold

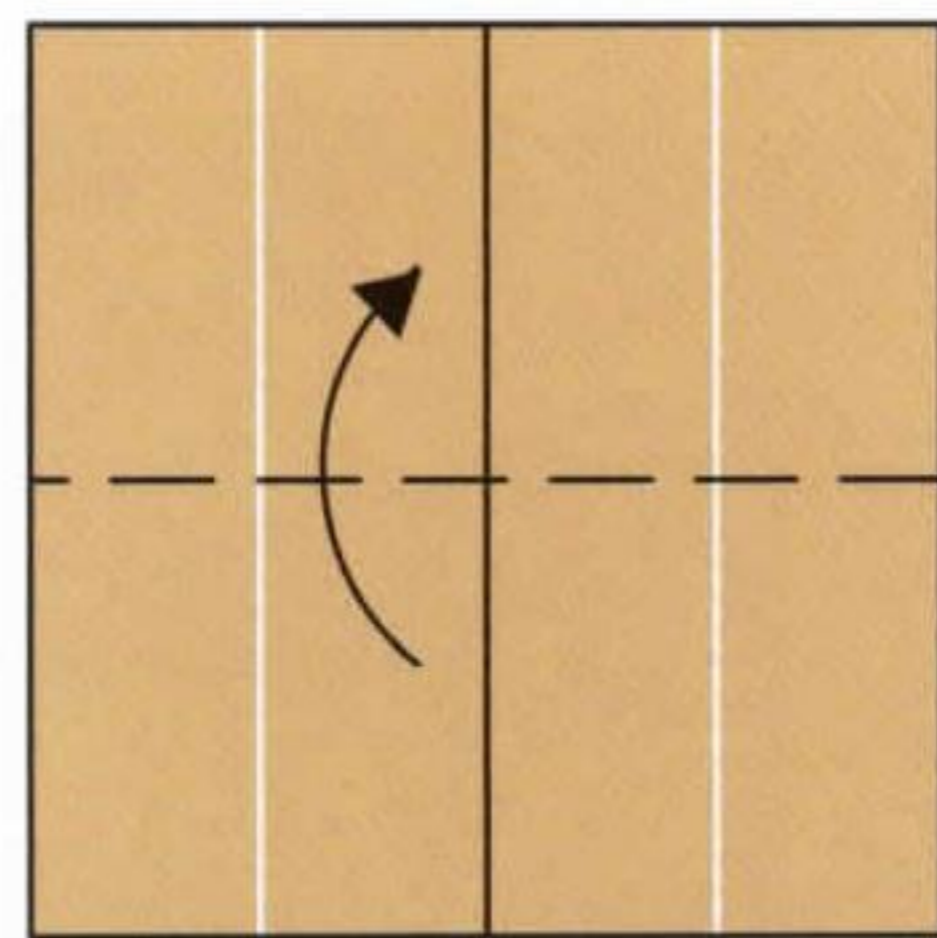

5. Valley fold

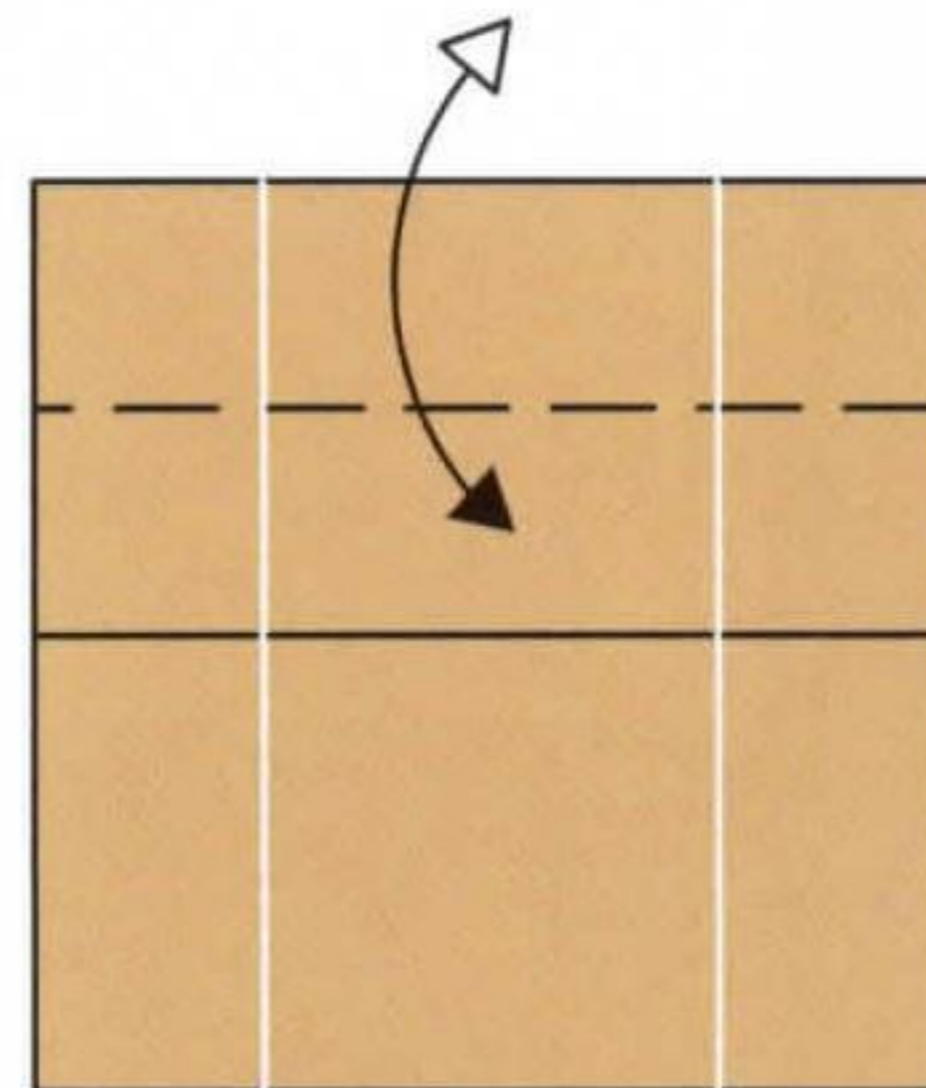

6. Valley fold and unfold

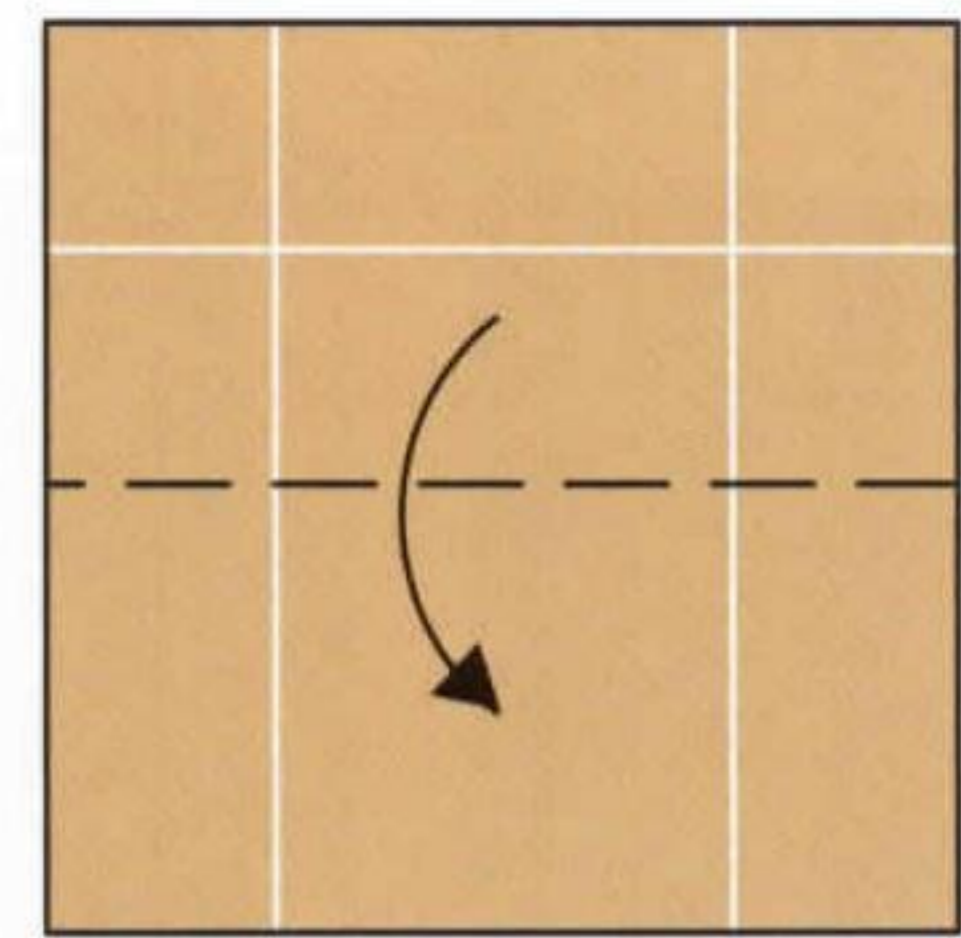

7. Valley fold

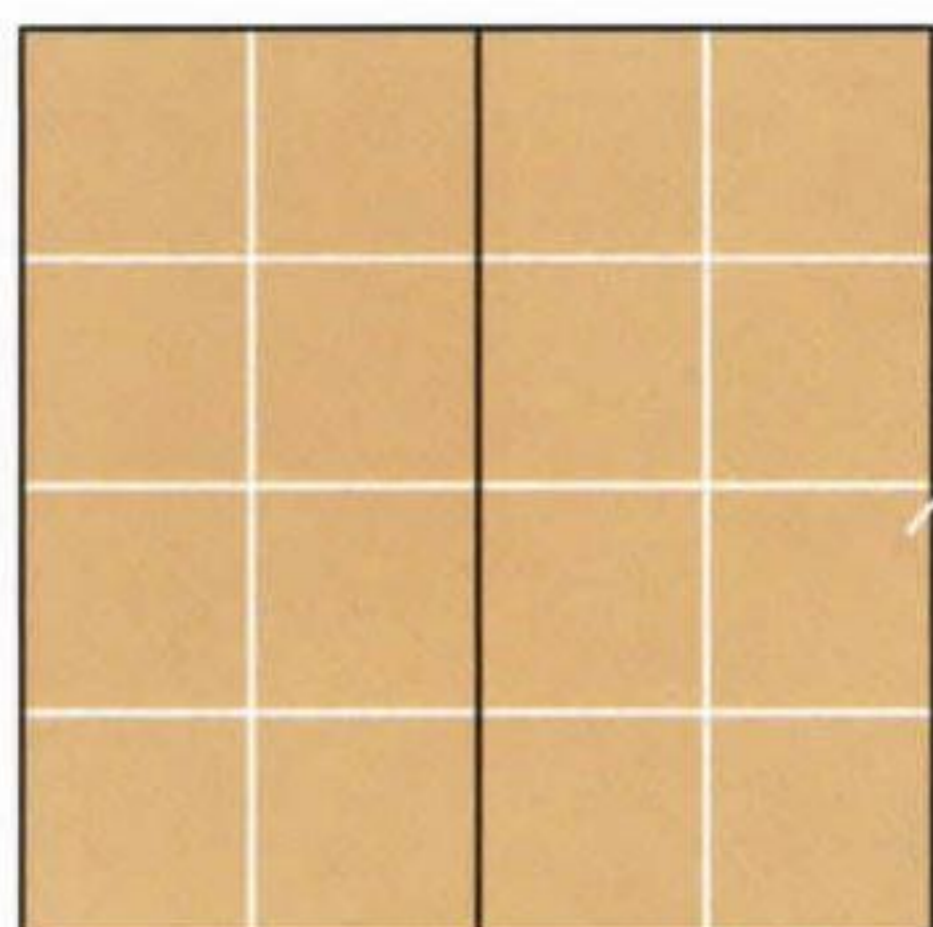

8. Turn over

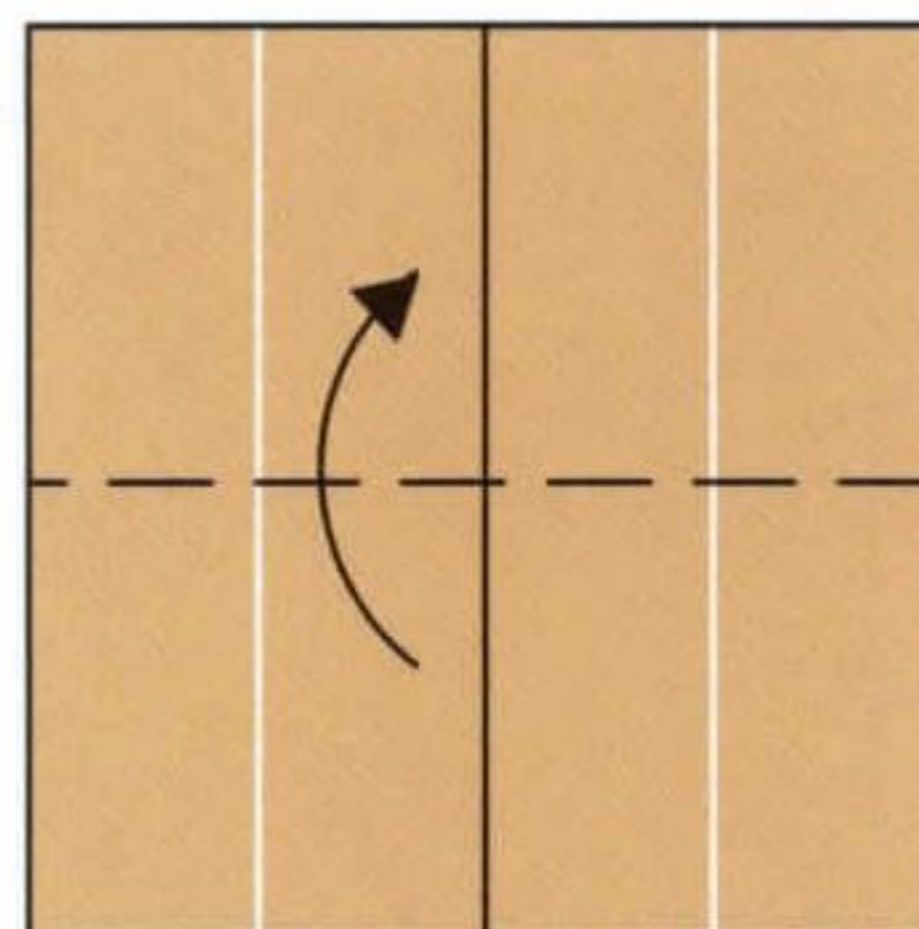

9. Repeat steps 5 to 7

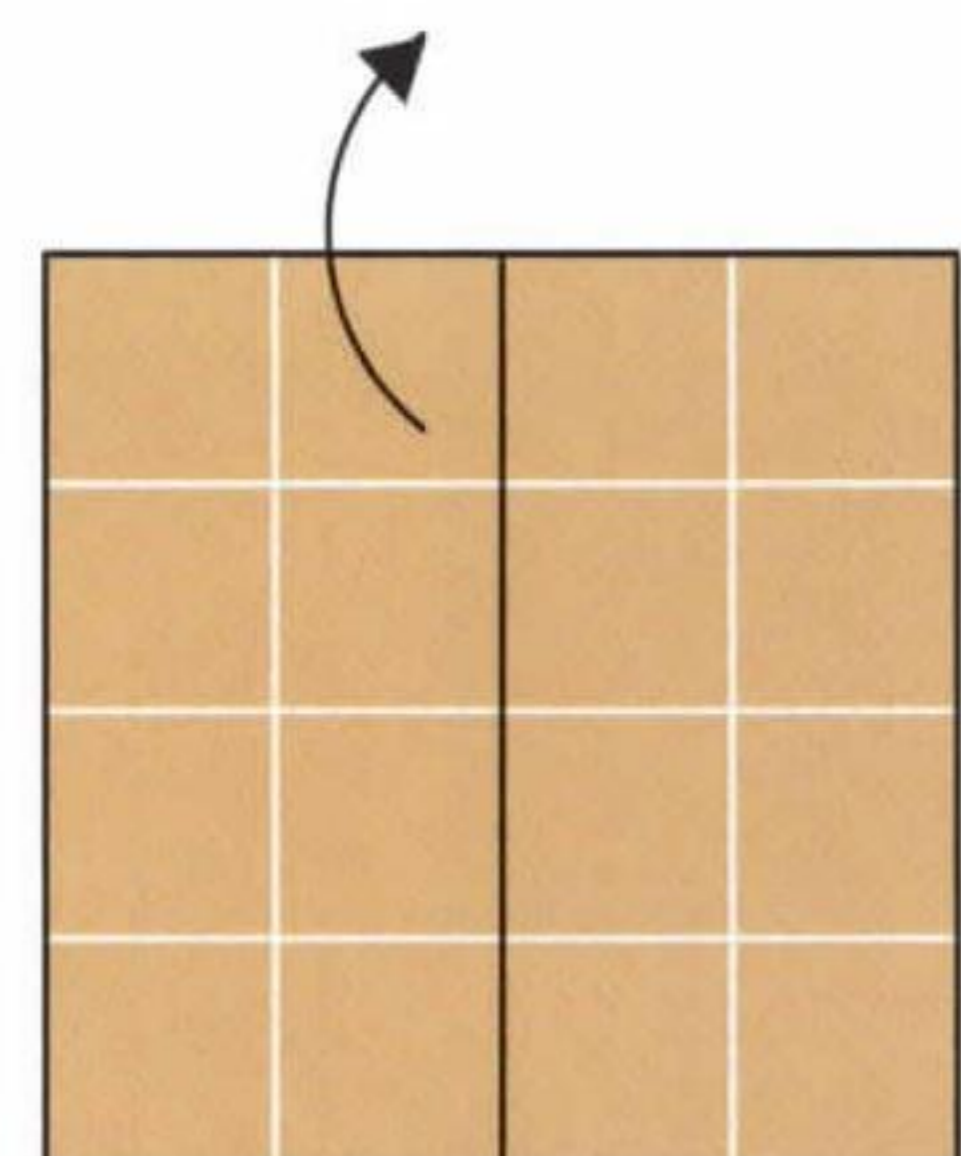

10. Valley fold

bookcase: part 1

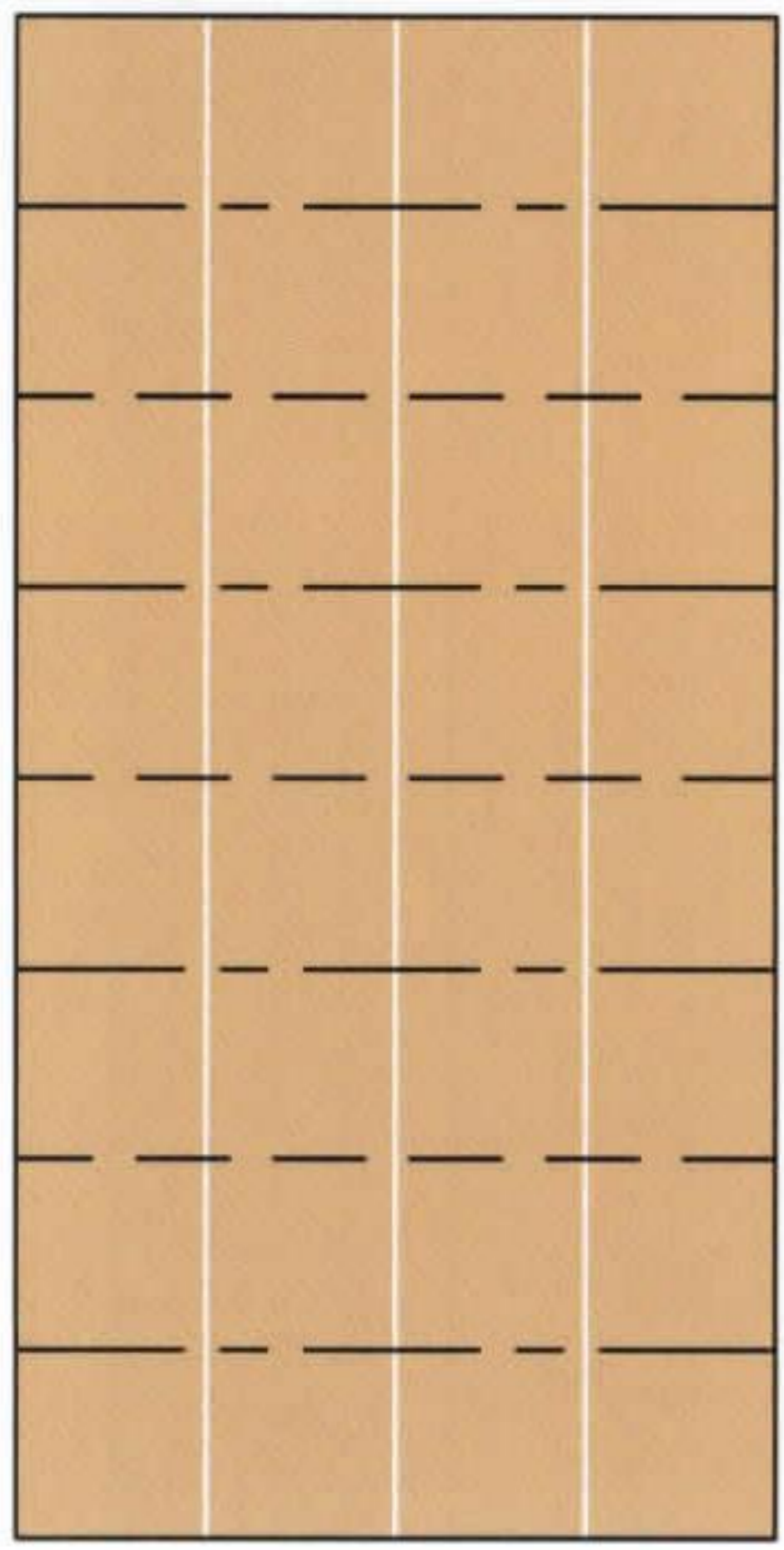

11. Pleat folds and unfold

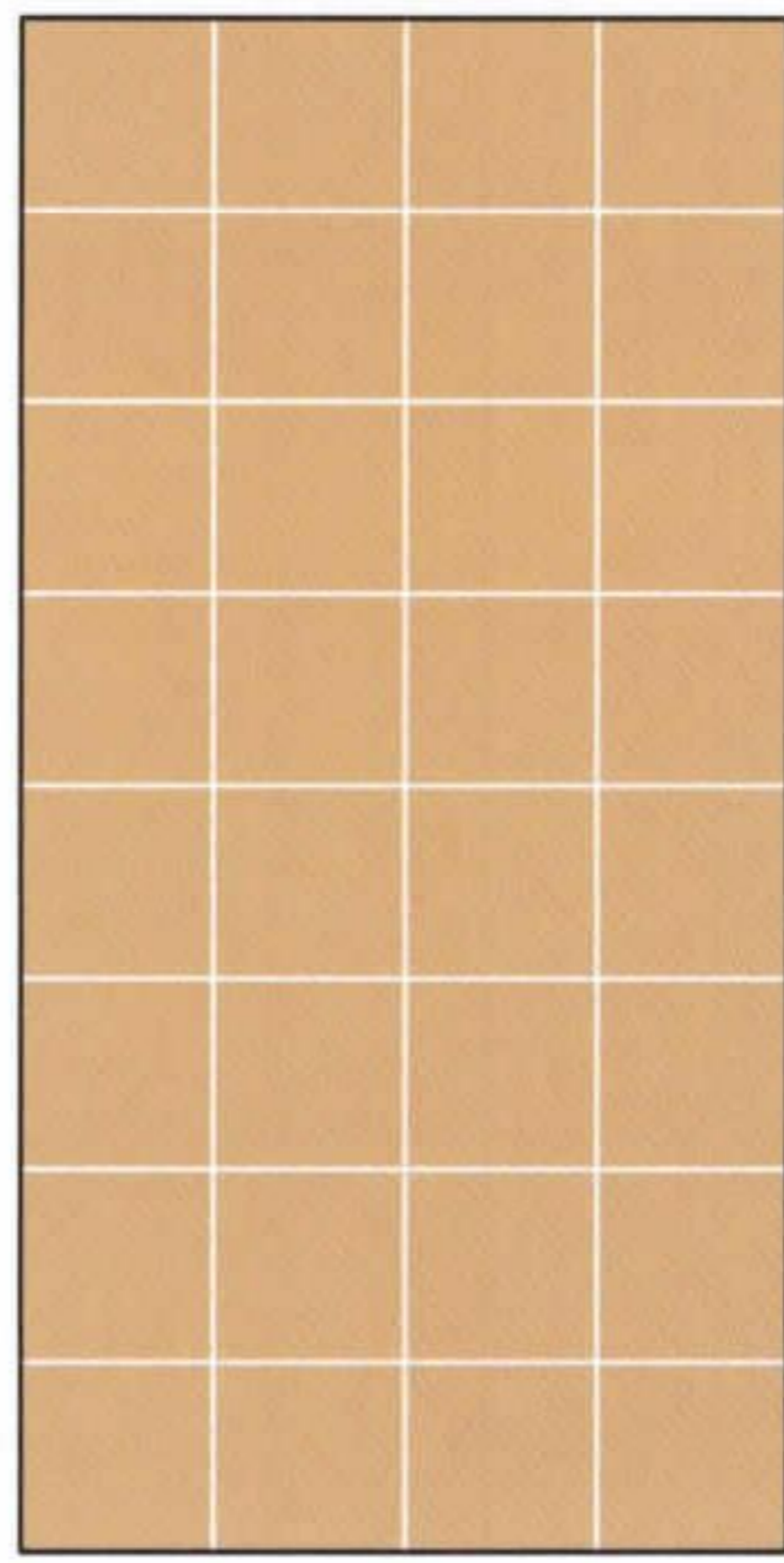

12. Turn over

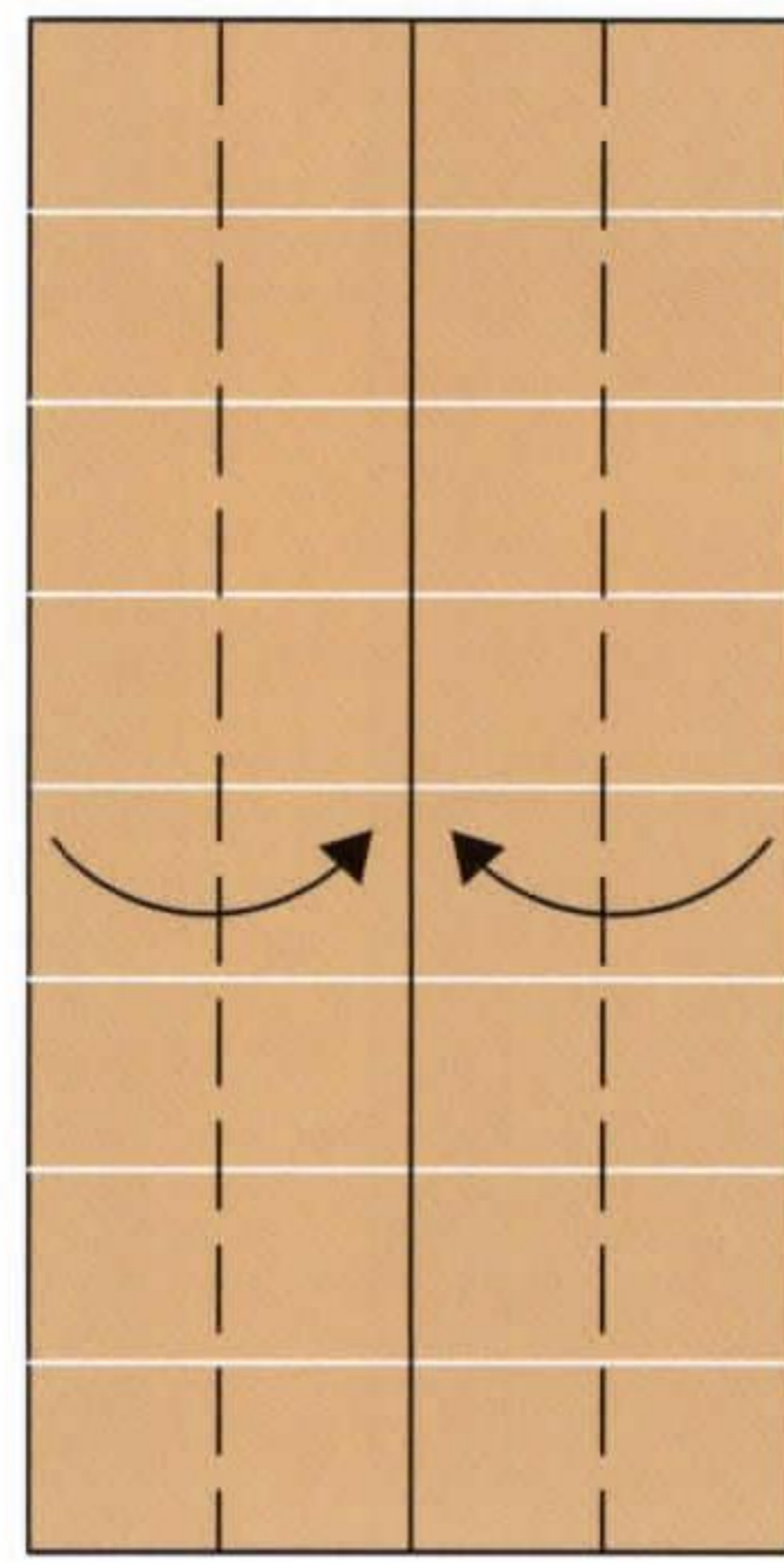

13. Valley folds

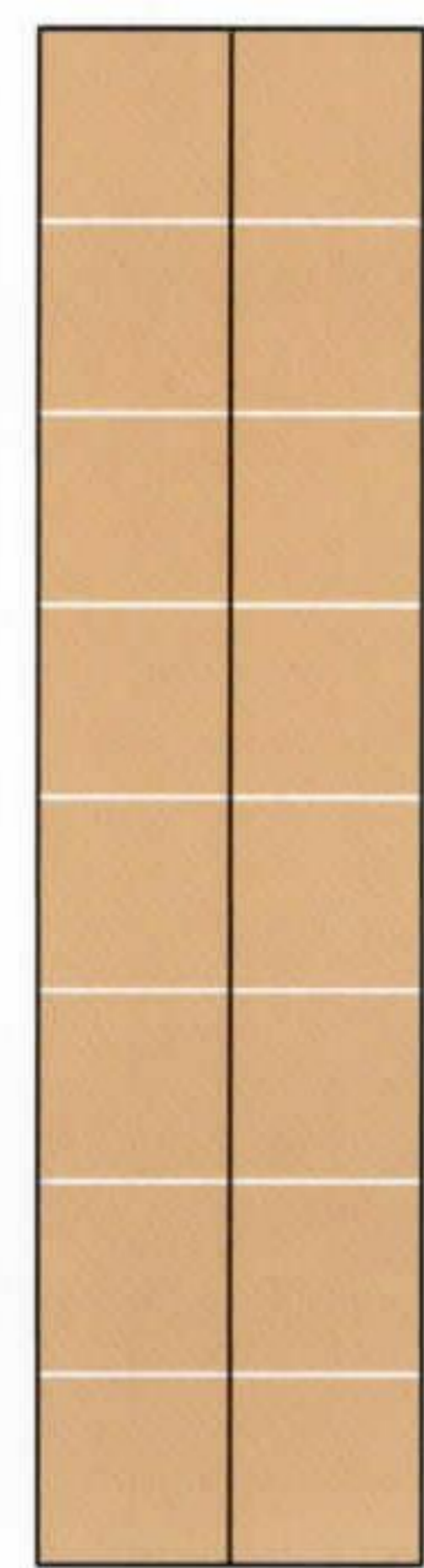

14. Scale-up

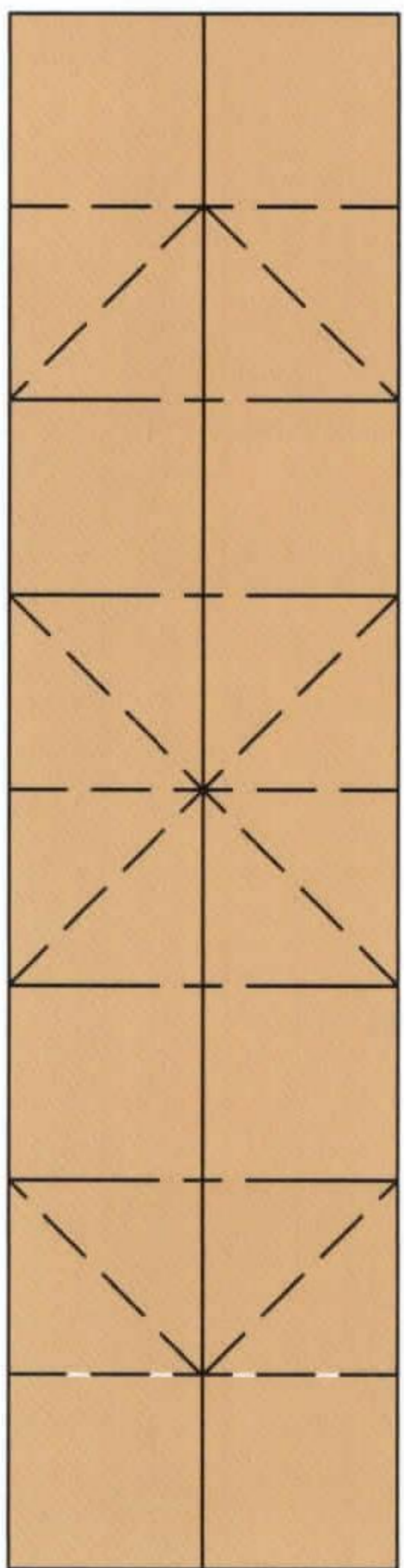

15. Pleat folds and crimp folds at the same time

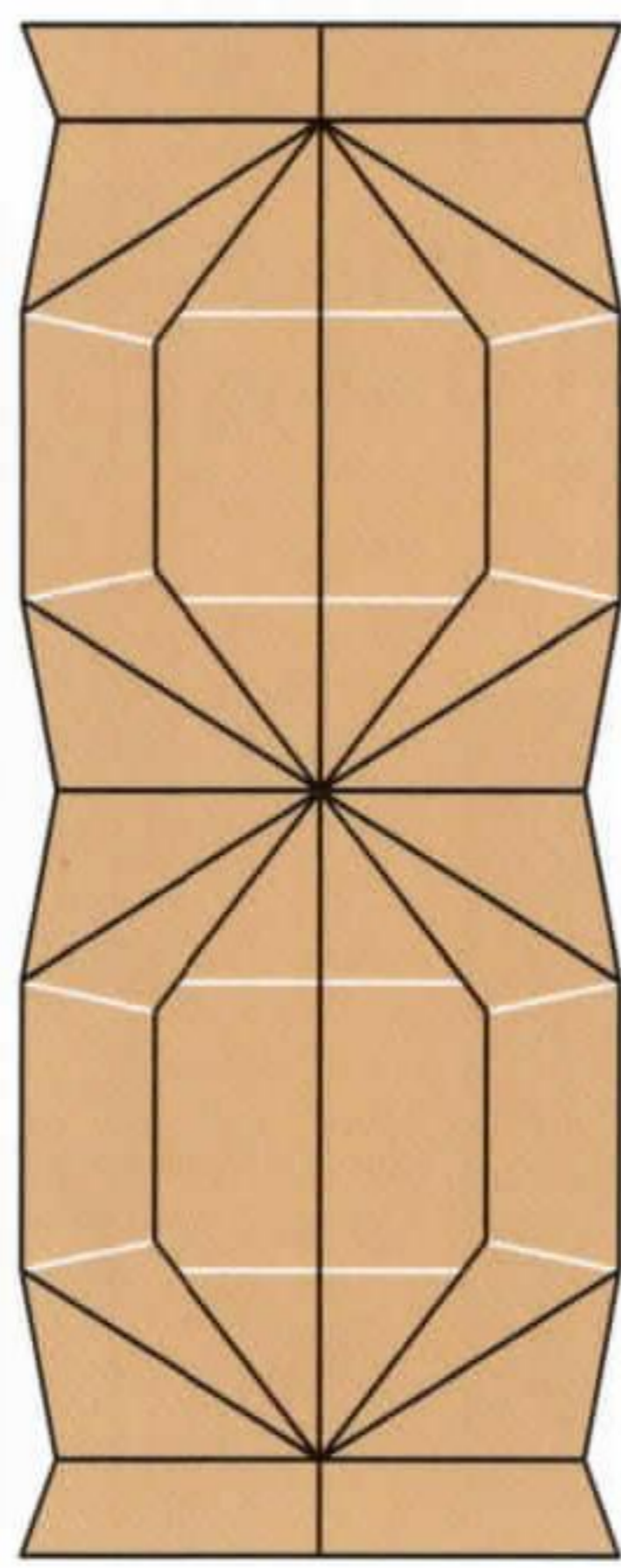

16. Before complete

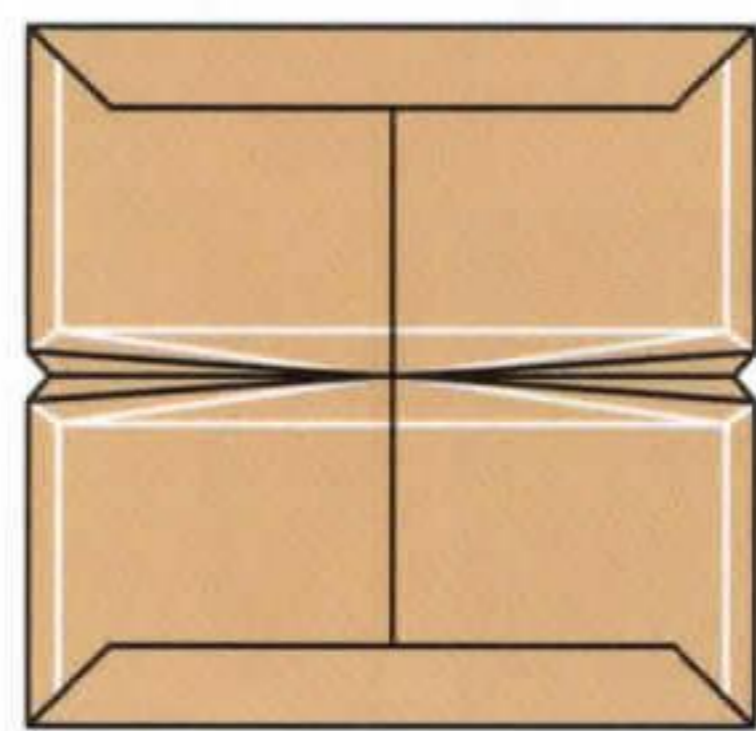

17. Add glue

FIRST ASSEMBLY

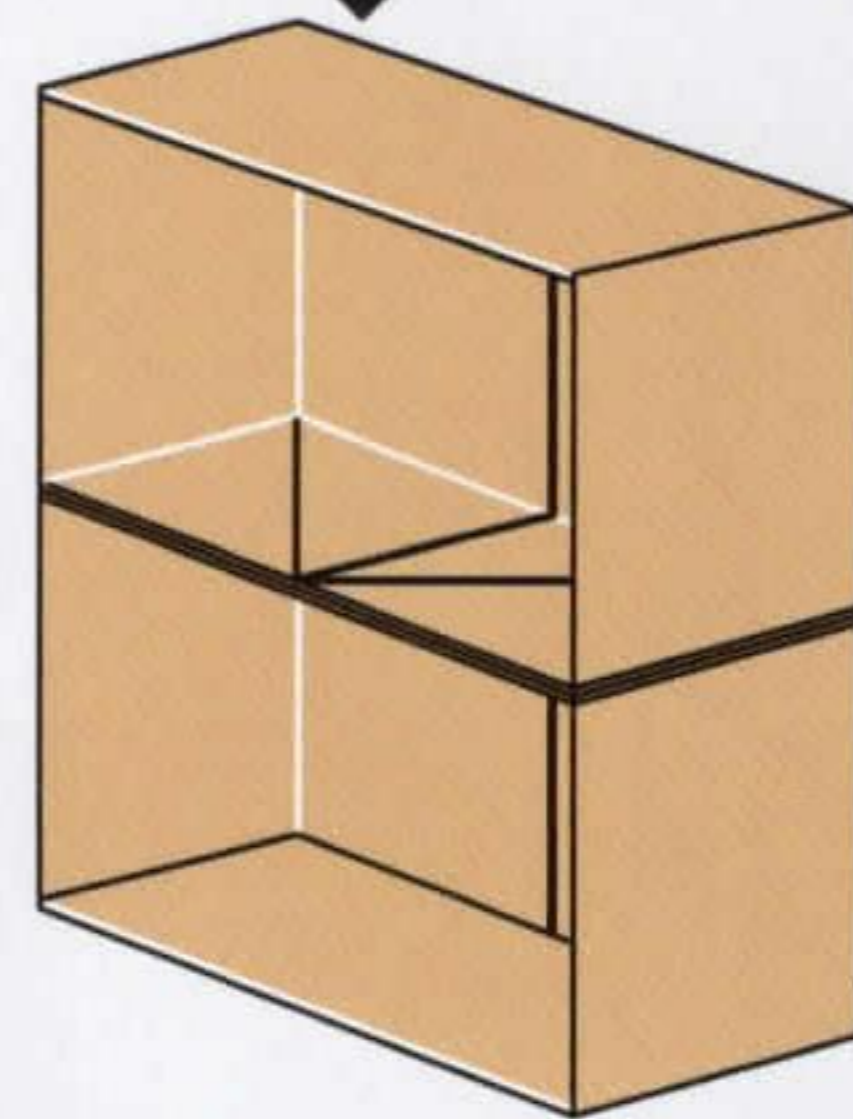
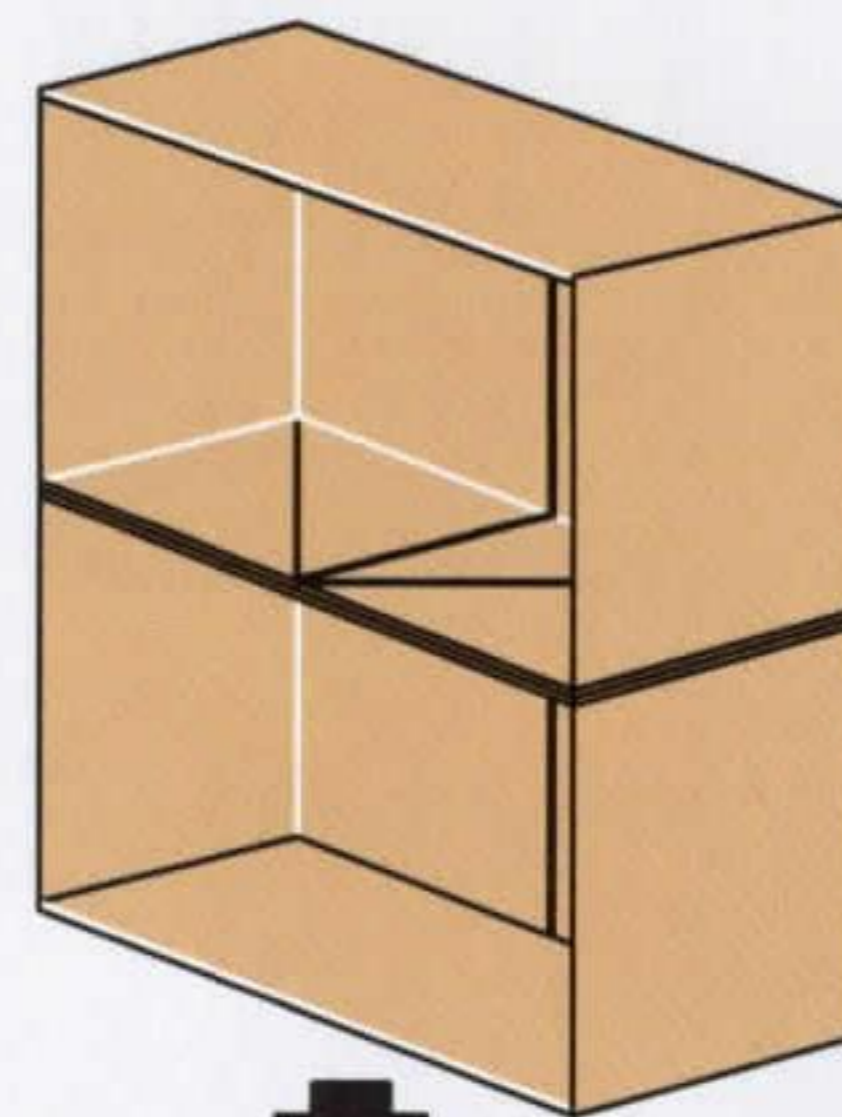

1. Make another one for the First Assembly

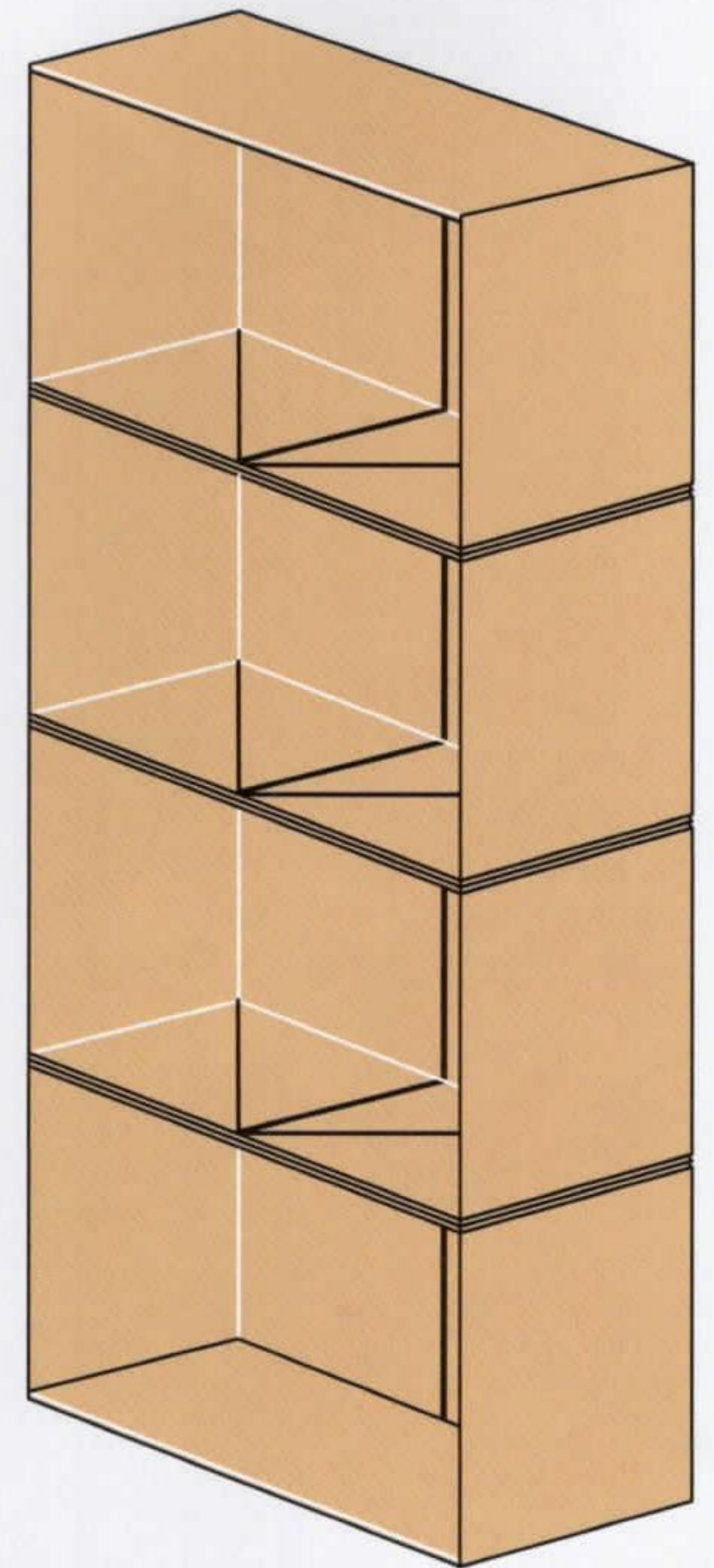

2. Completed PART 1 and FIRST ASSEMBLY

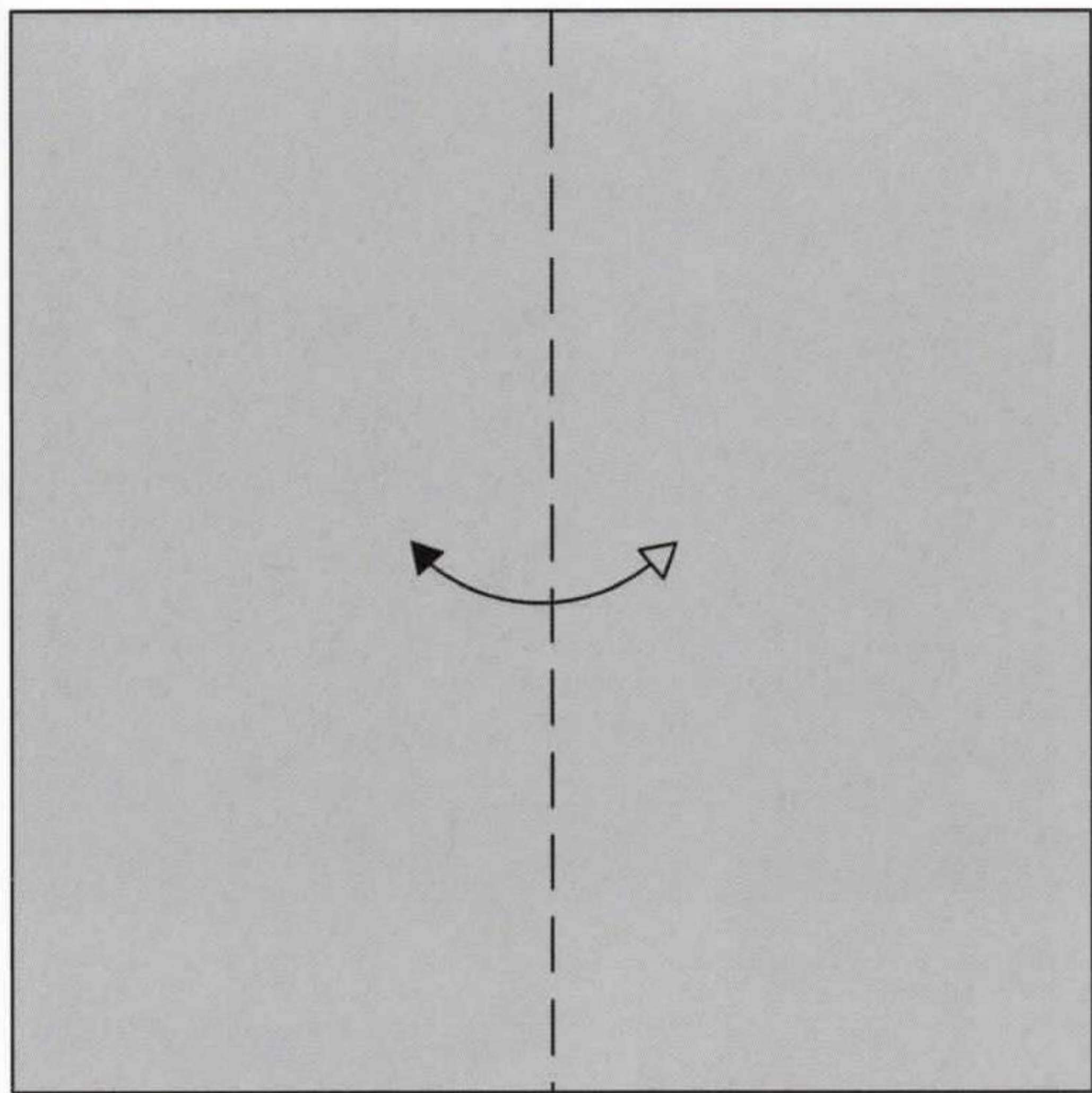

1. Valley fold and unfold

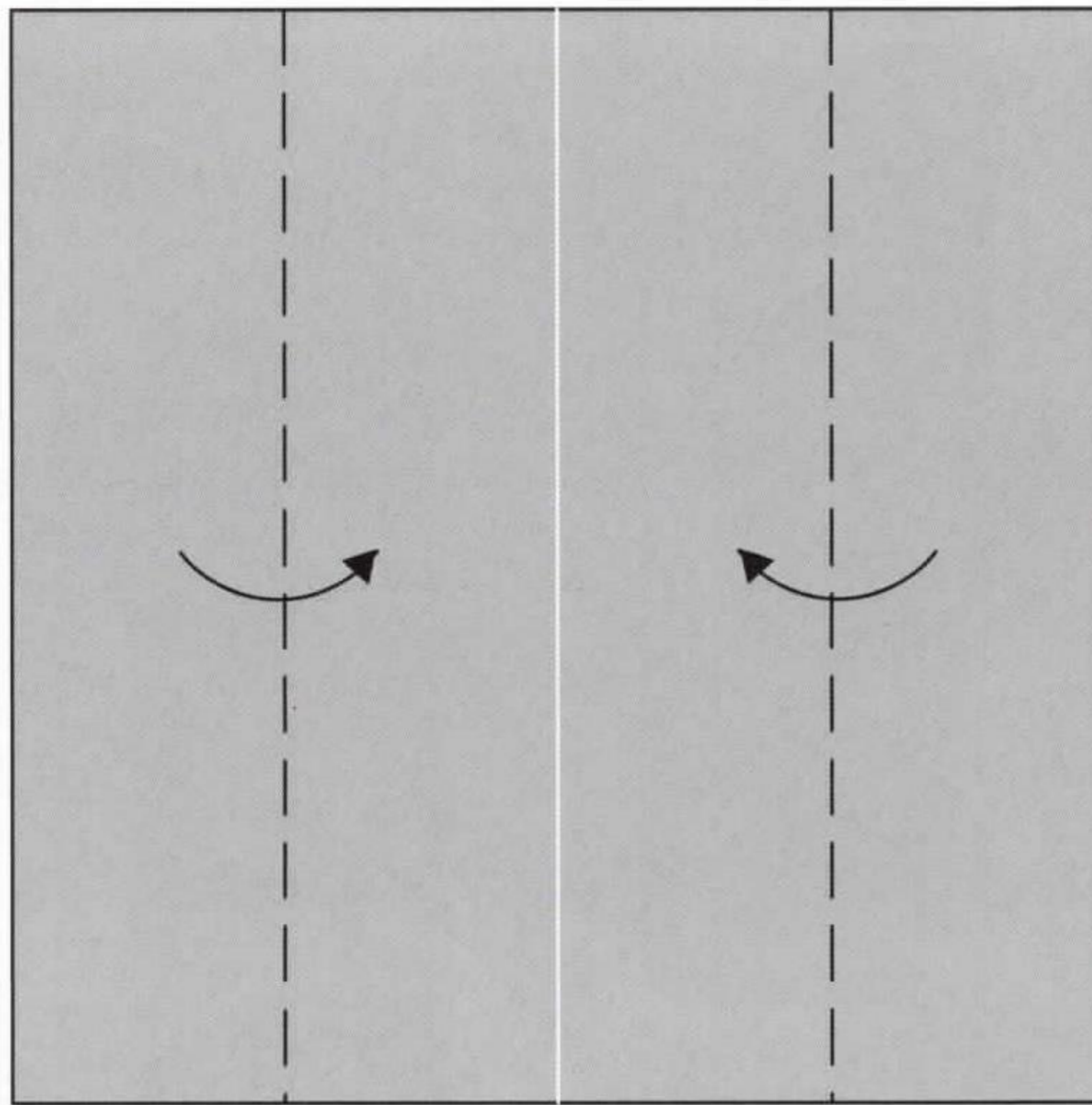

2. Valley folds

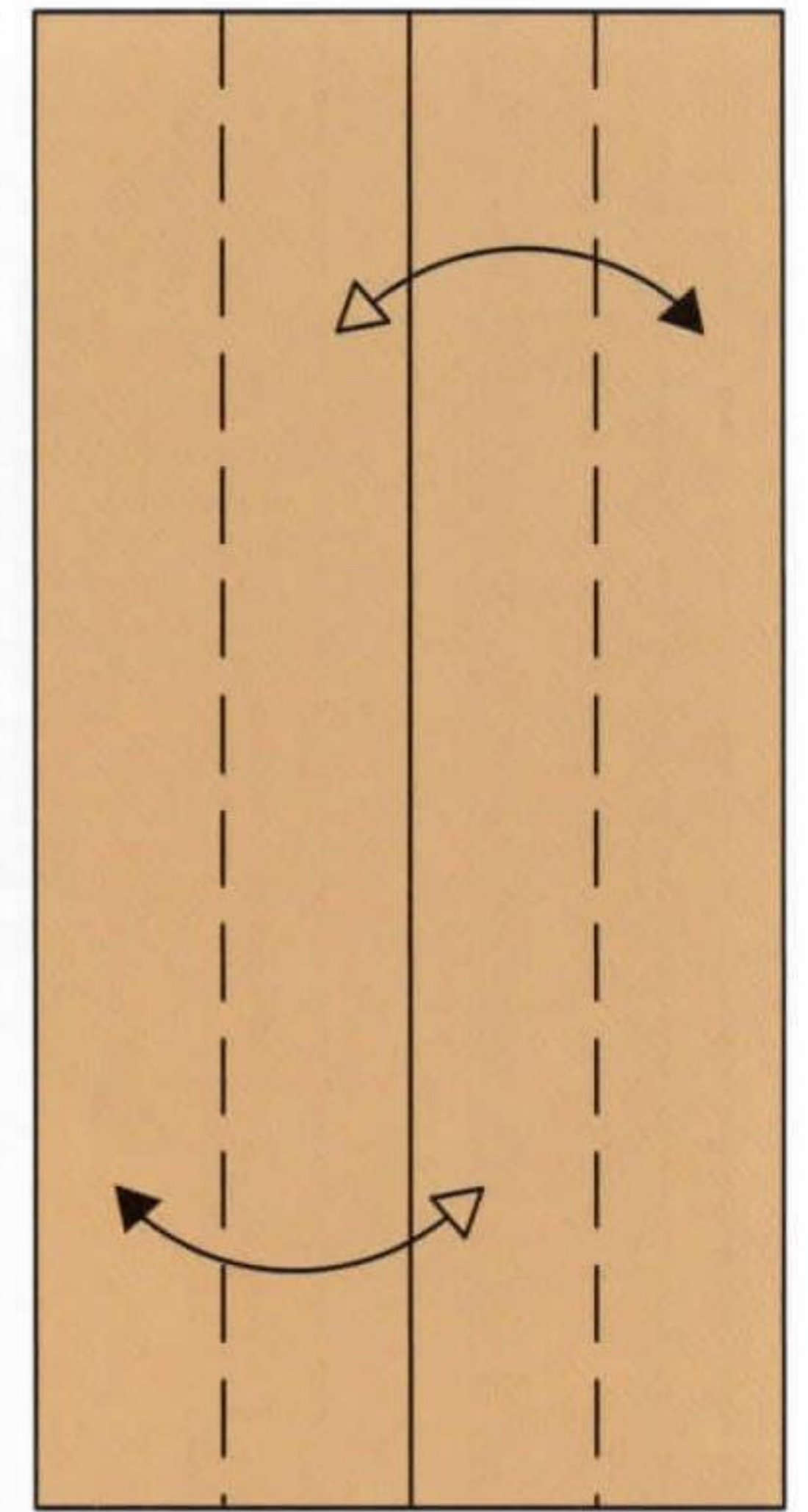

3. Valley folds and unfold

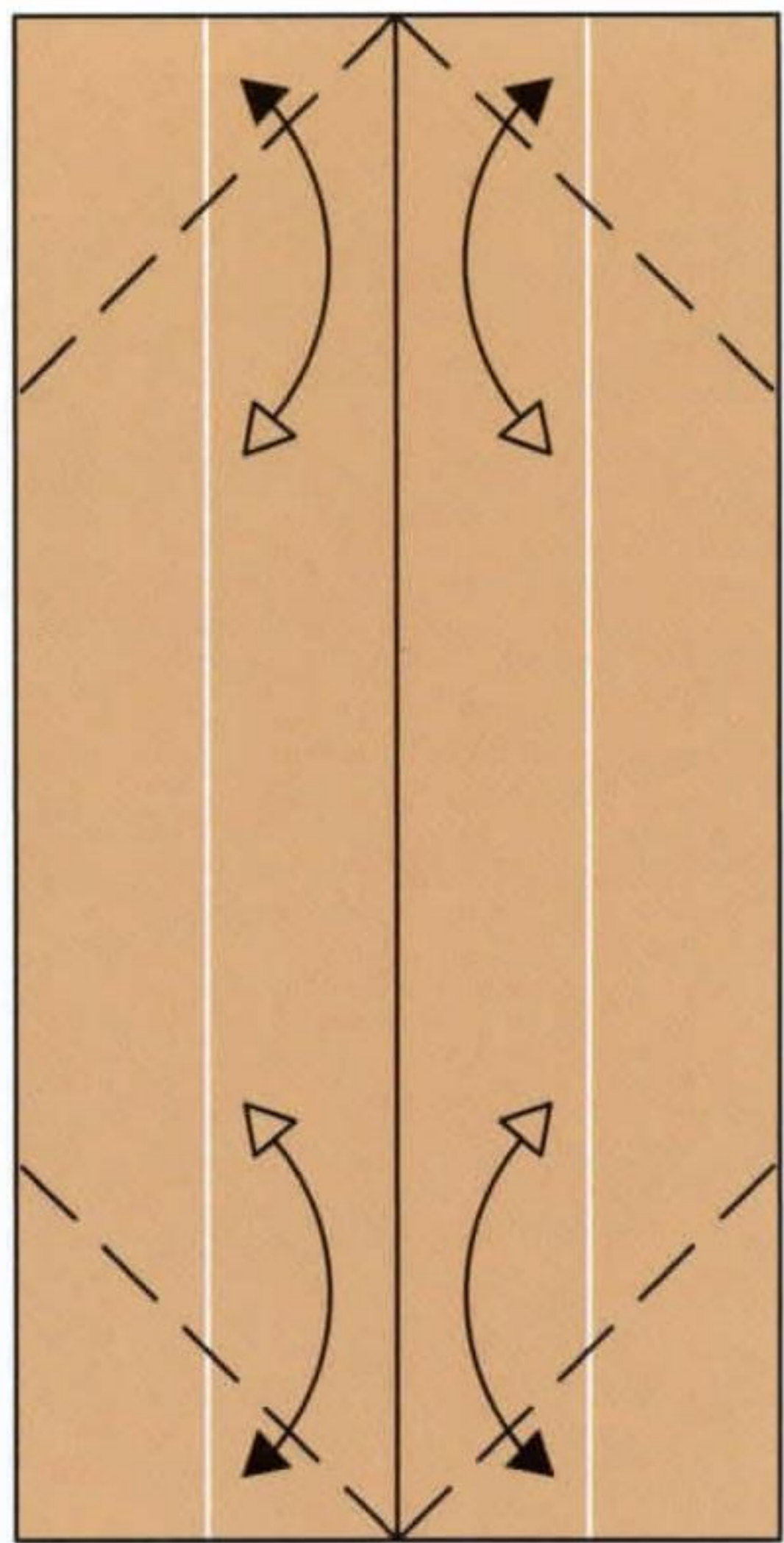

4. Valley folds and unfolds

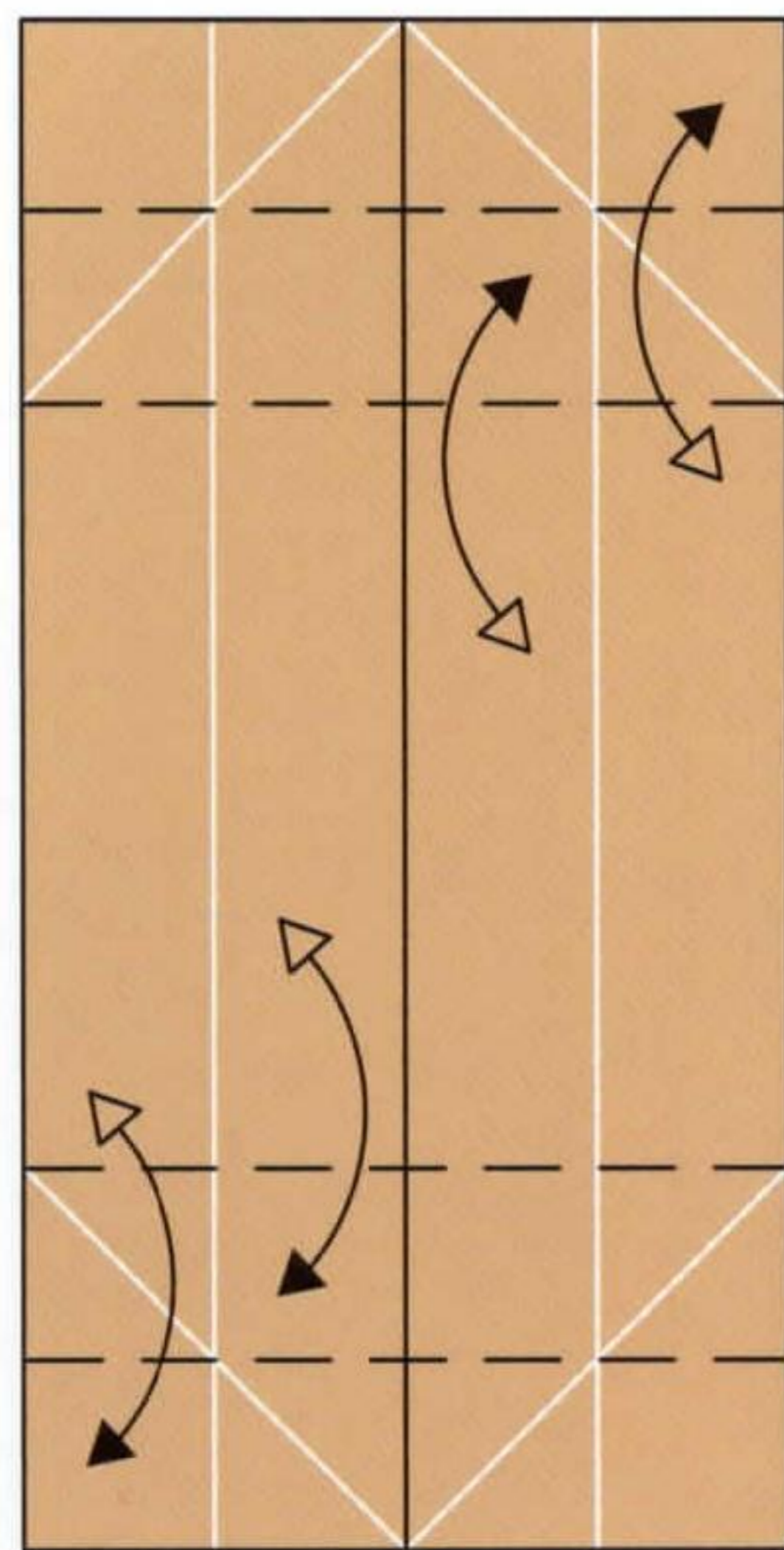

5. Repeat

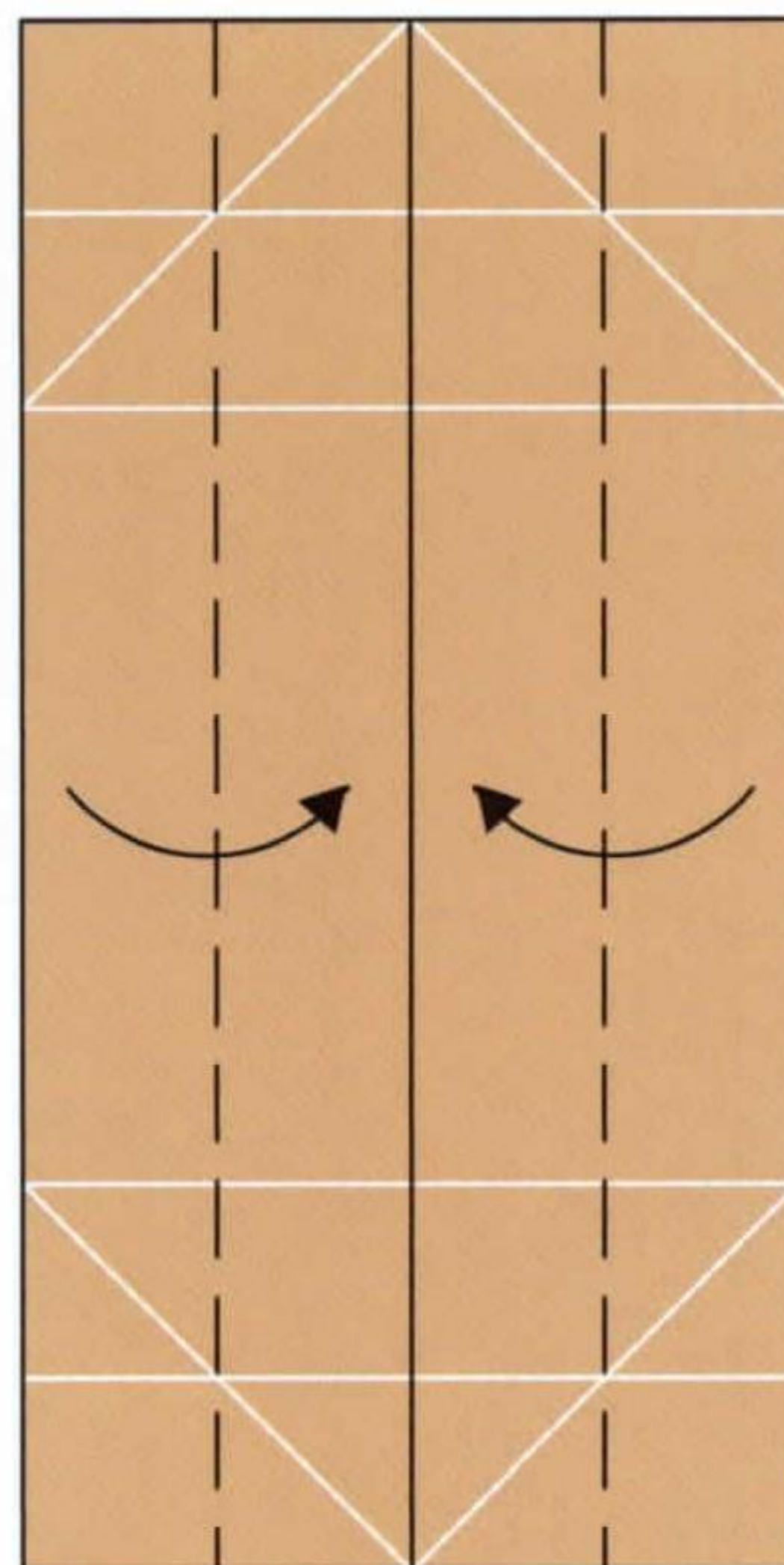

6. Valley folds

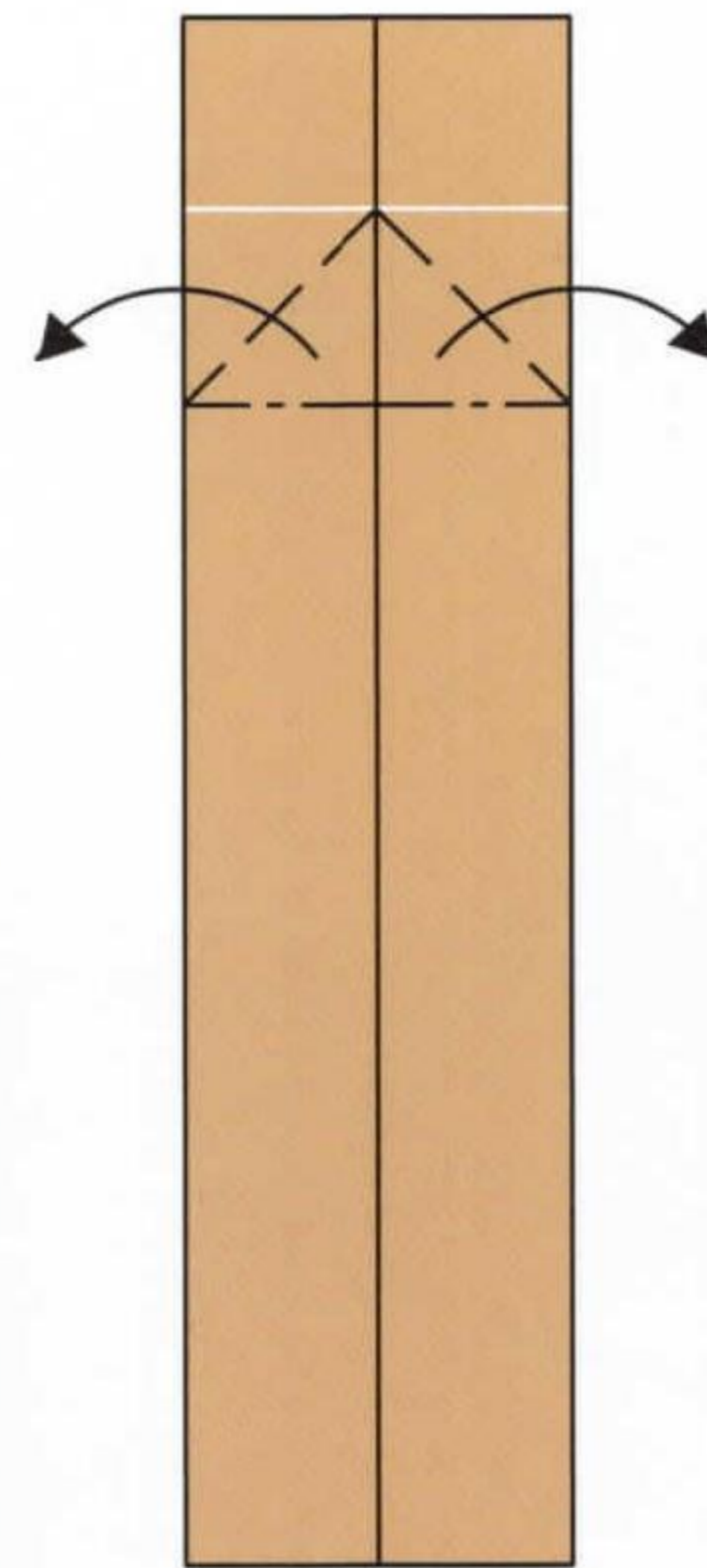

7. Crimp folds

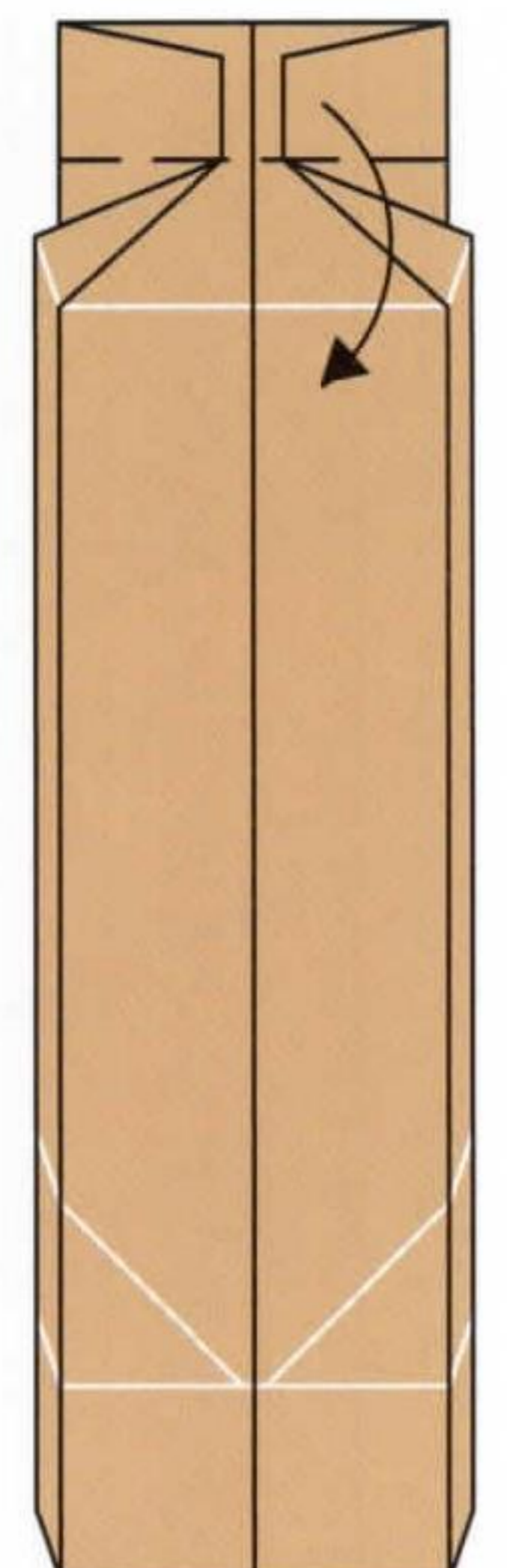

8. Valley fold

bookcase: part 2

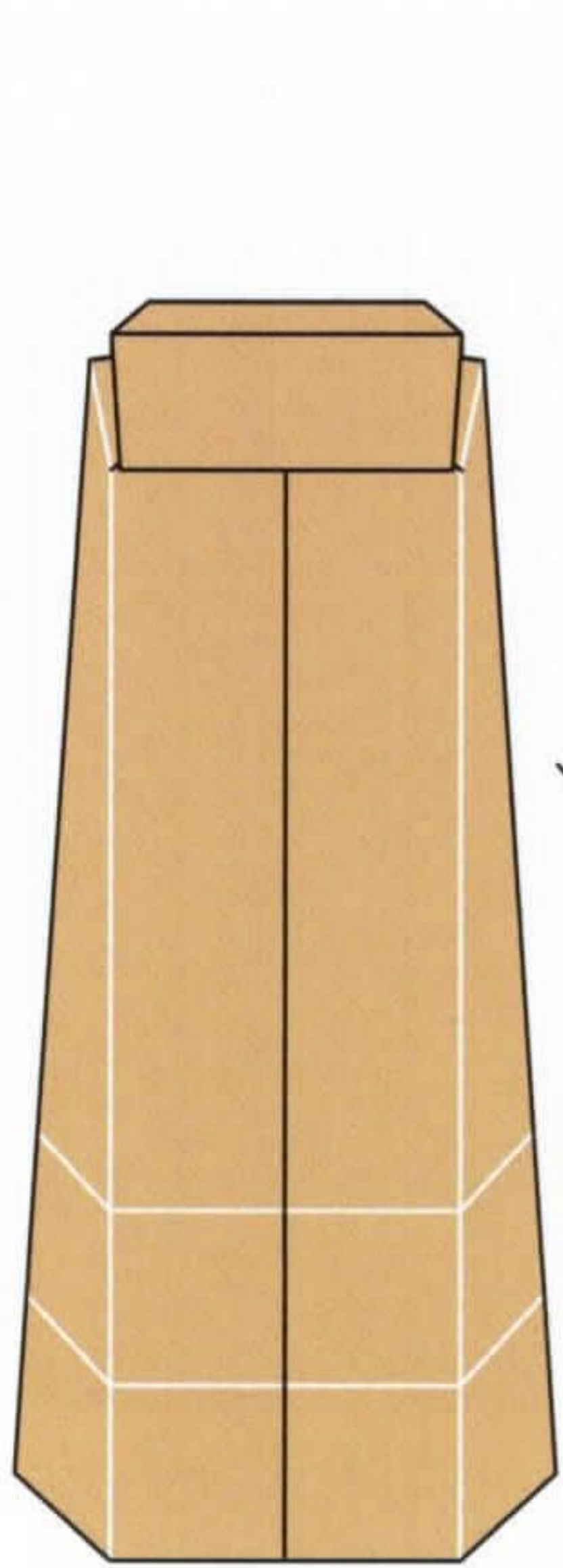

9. Rotate

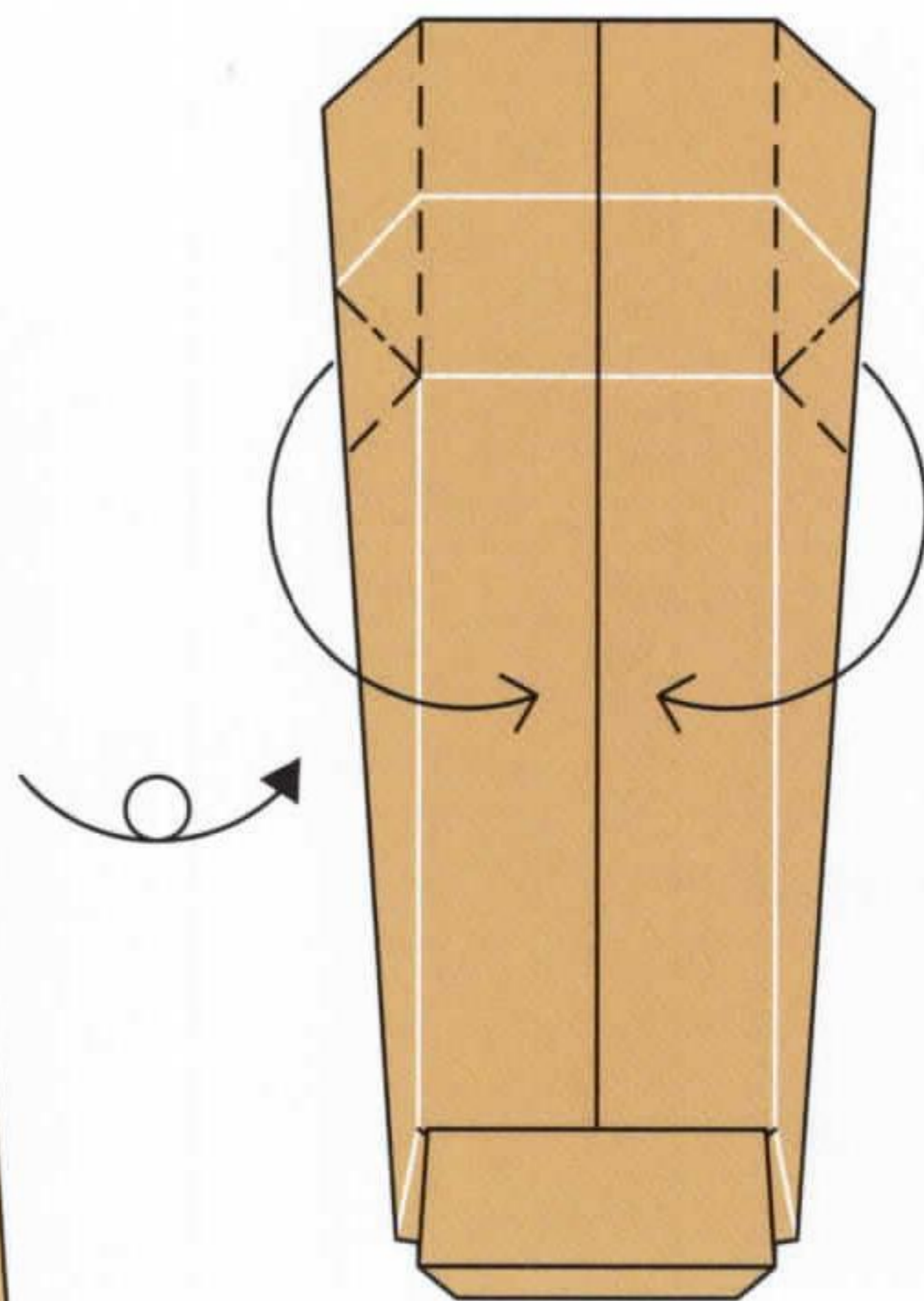

10. Crimp folds

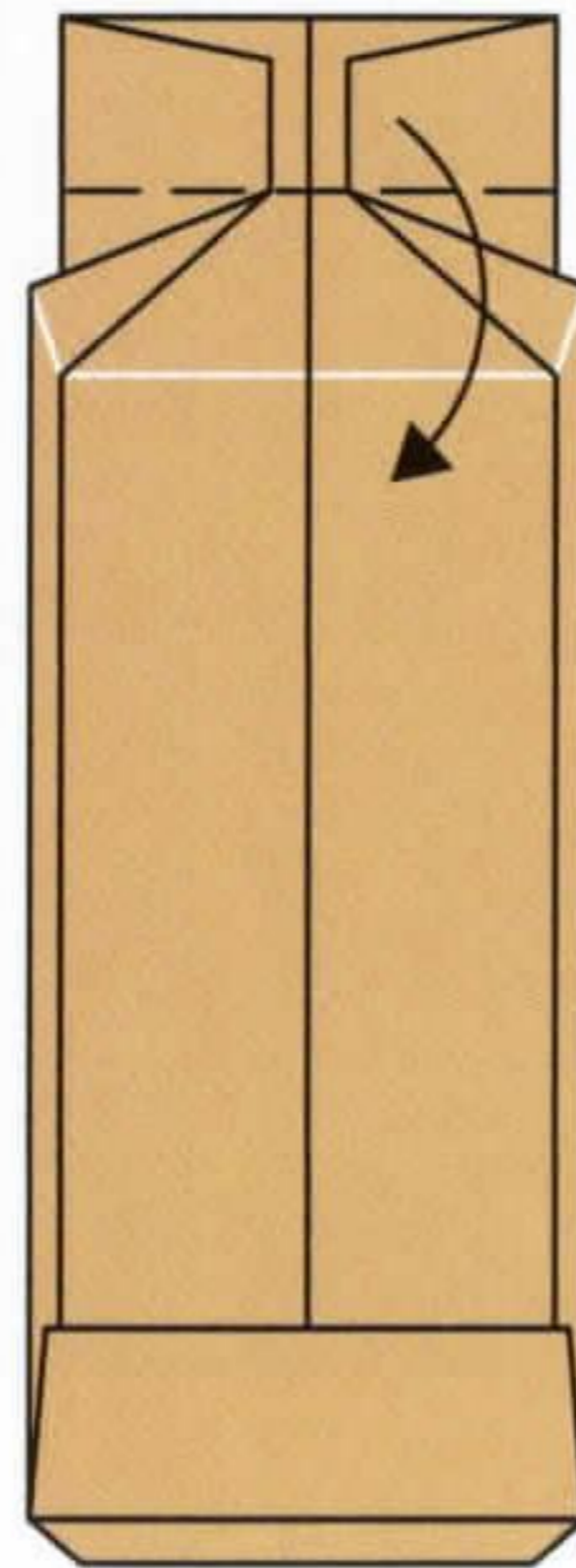

11. Valley fold



12. Push to close

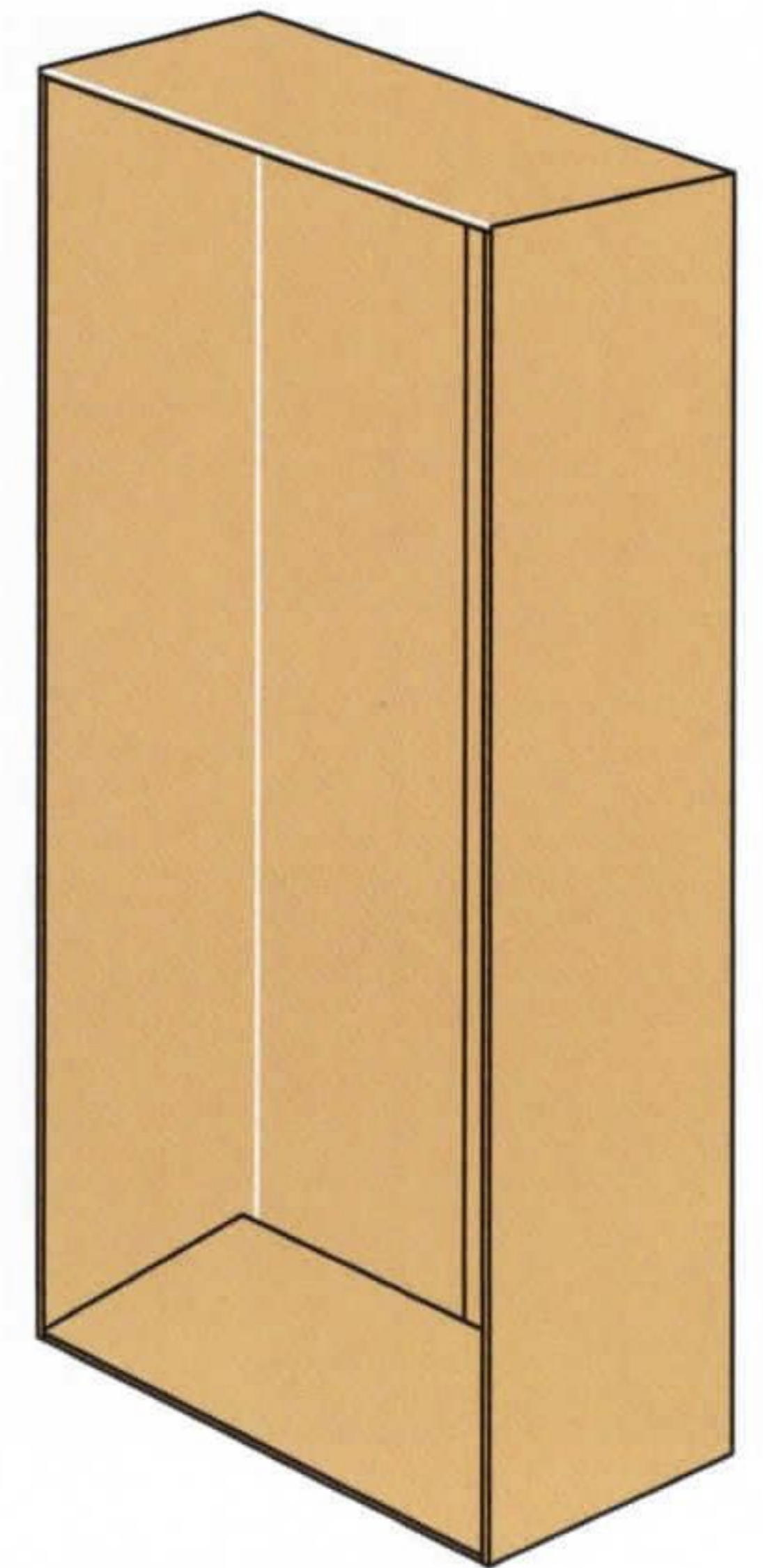

13. Completed PART 2

SECOND ASSEMBLY

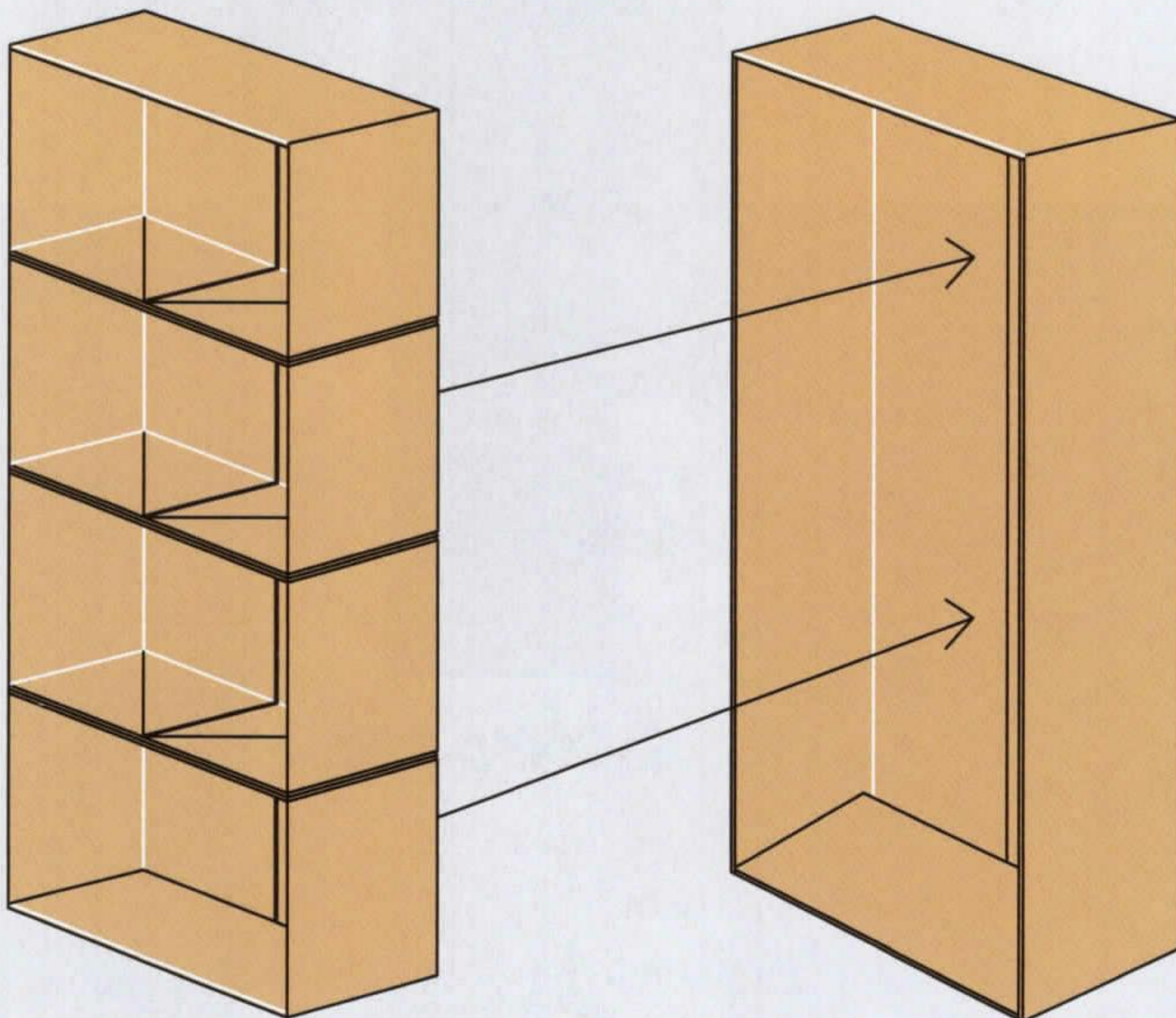

1. Insert as indicated by the arrows and apply glue if needed

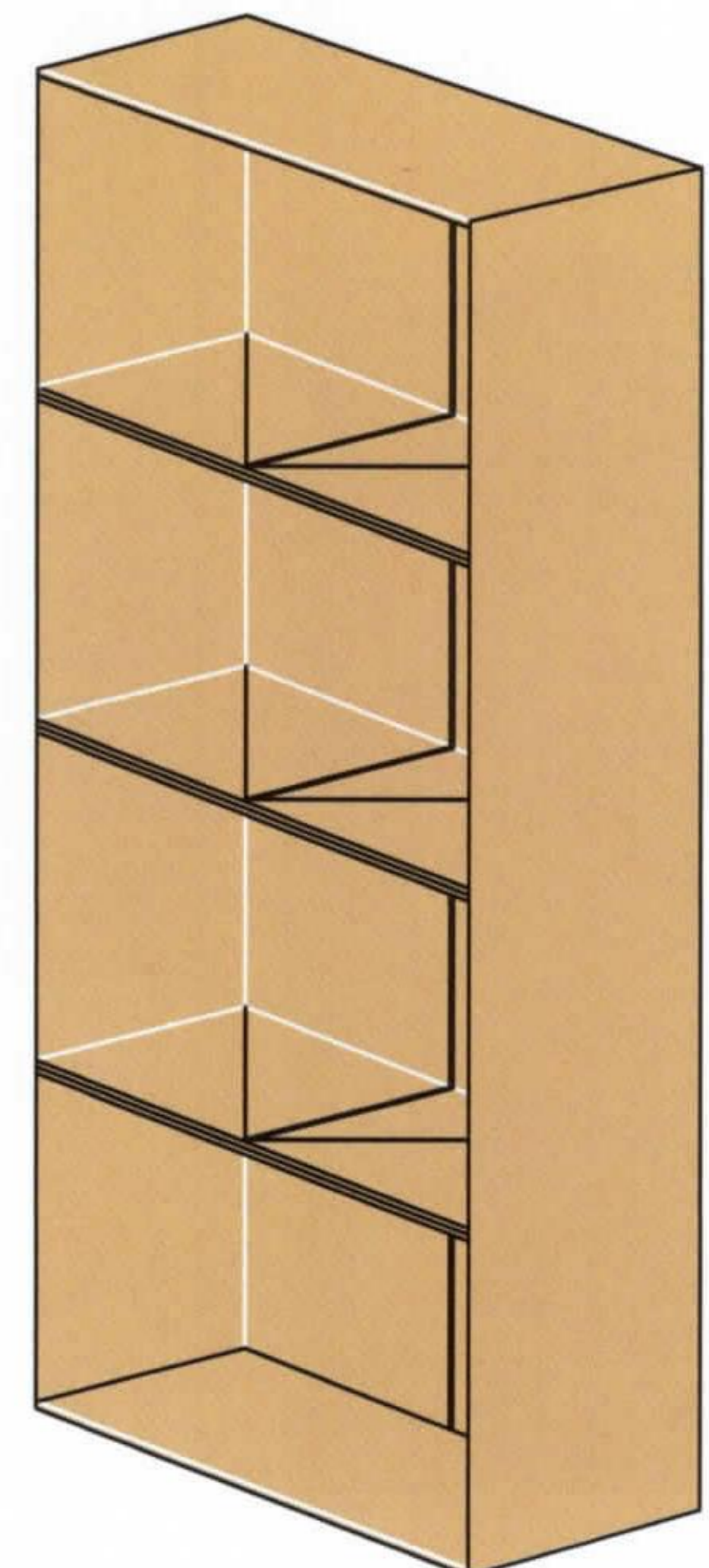

2. Completed BOOKCASE

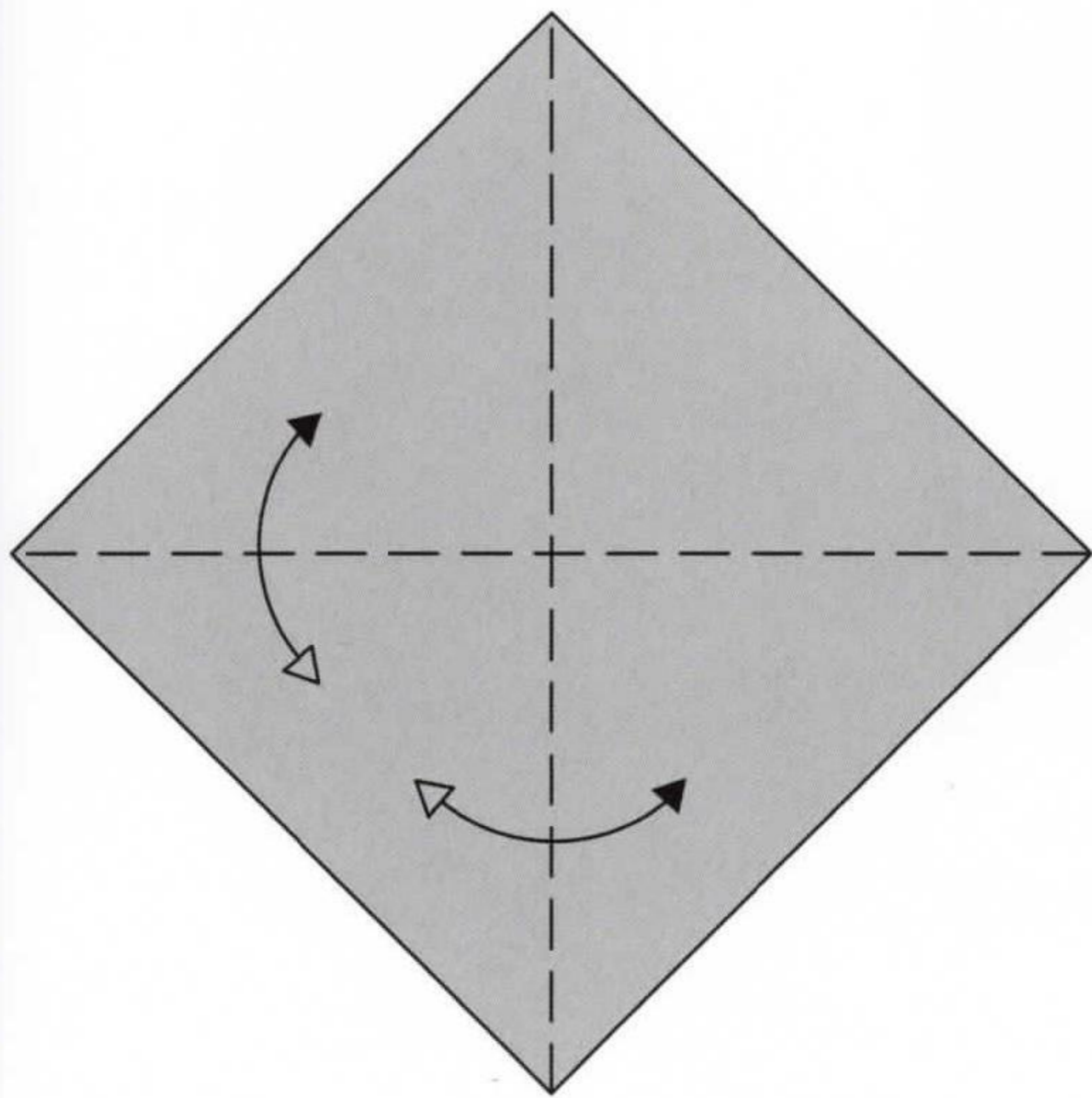

1. Valley fold and unfold

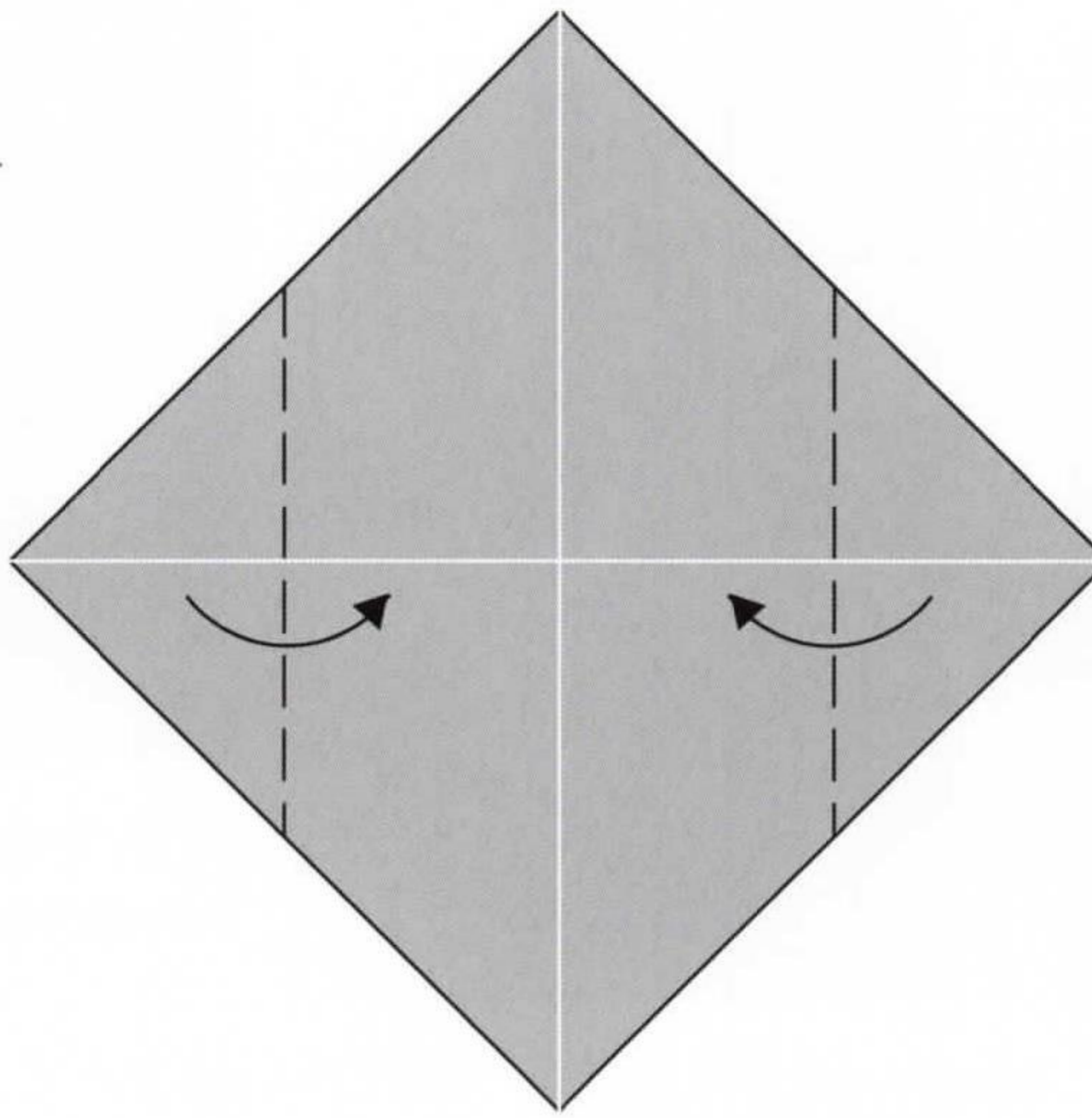

2. Valley folds

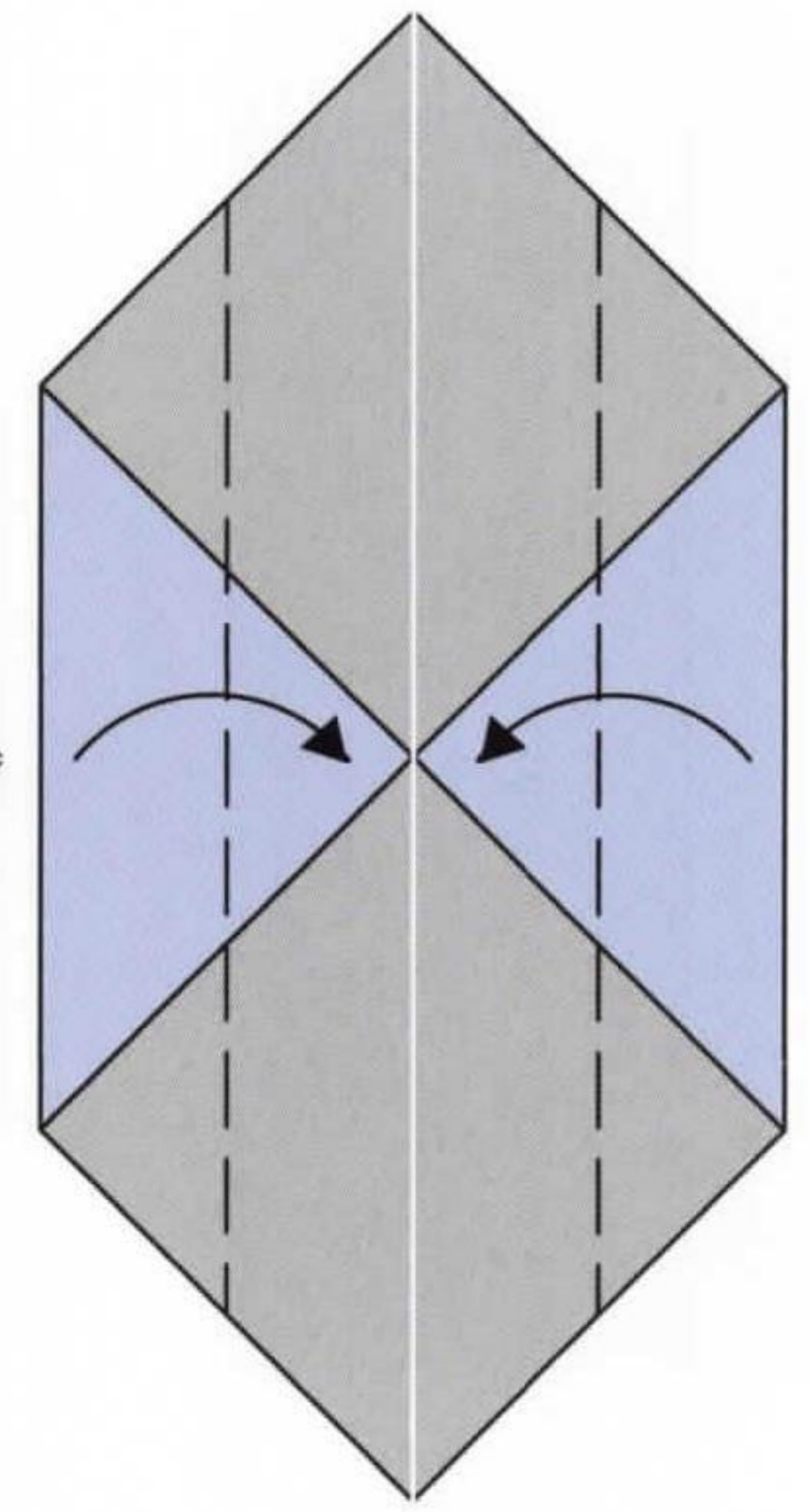

3. Valley folds

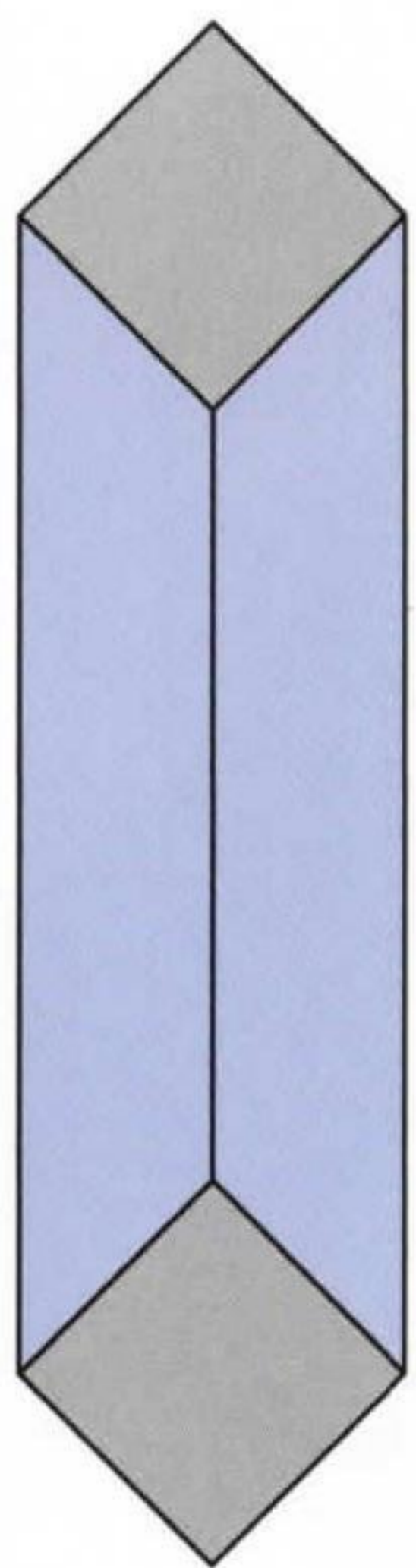

4. Scale-up

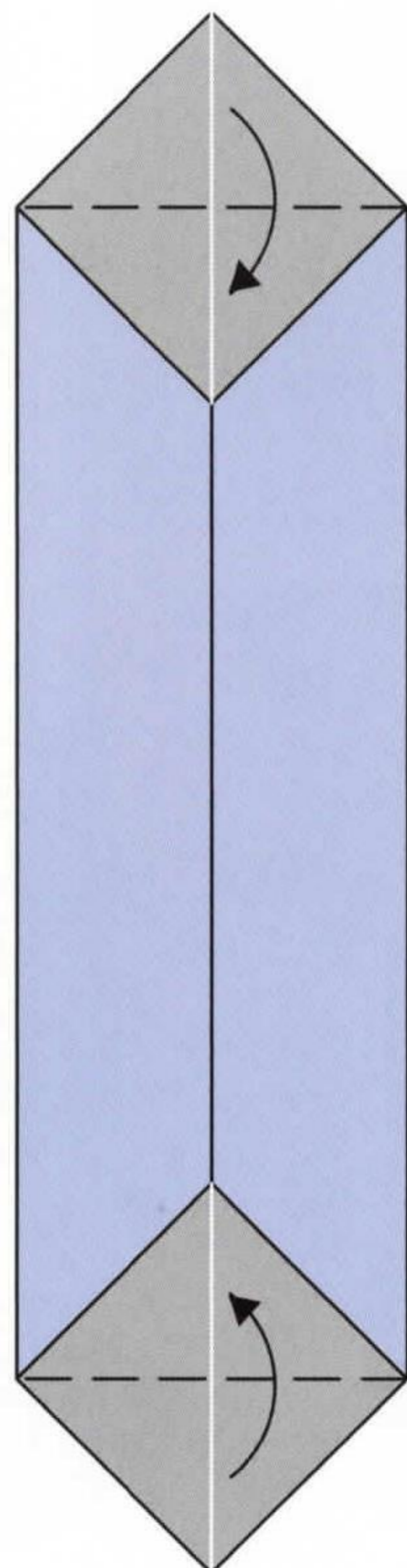

5. Valley folds

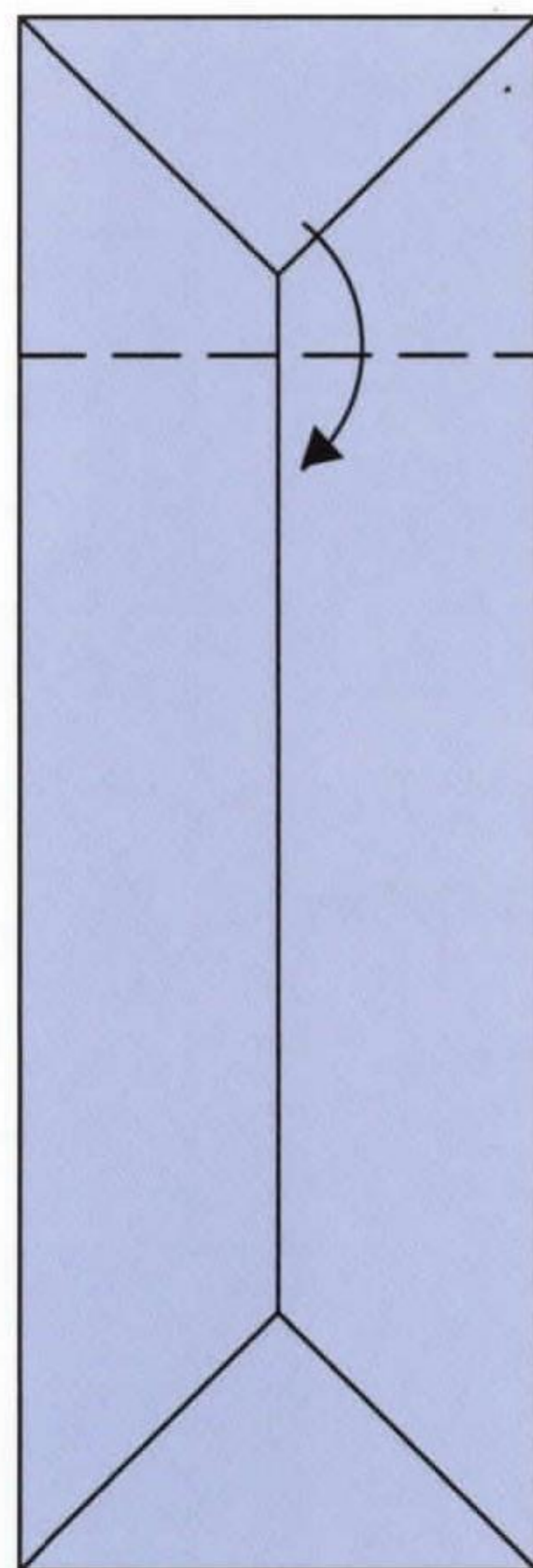

6. Valley fold

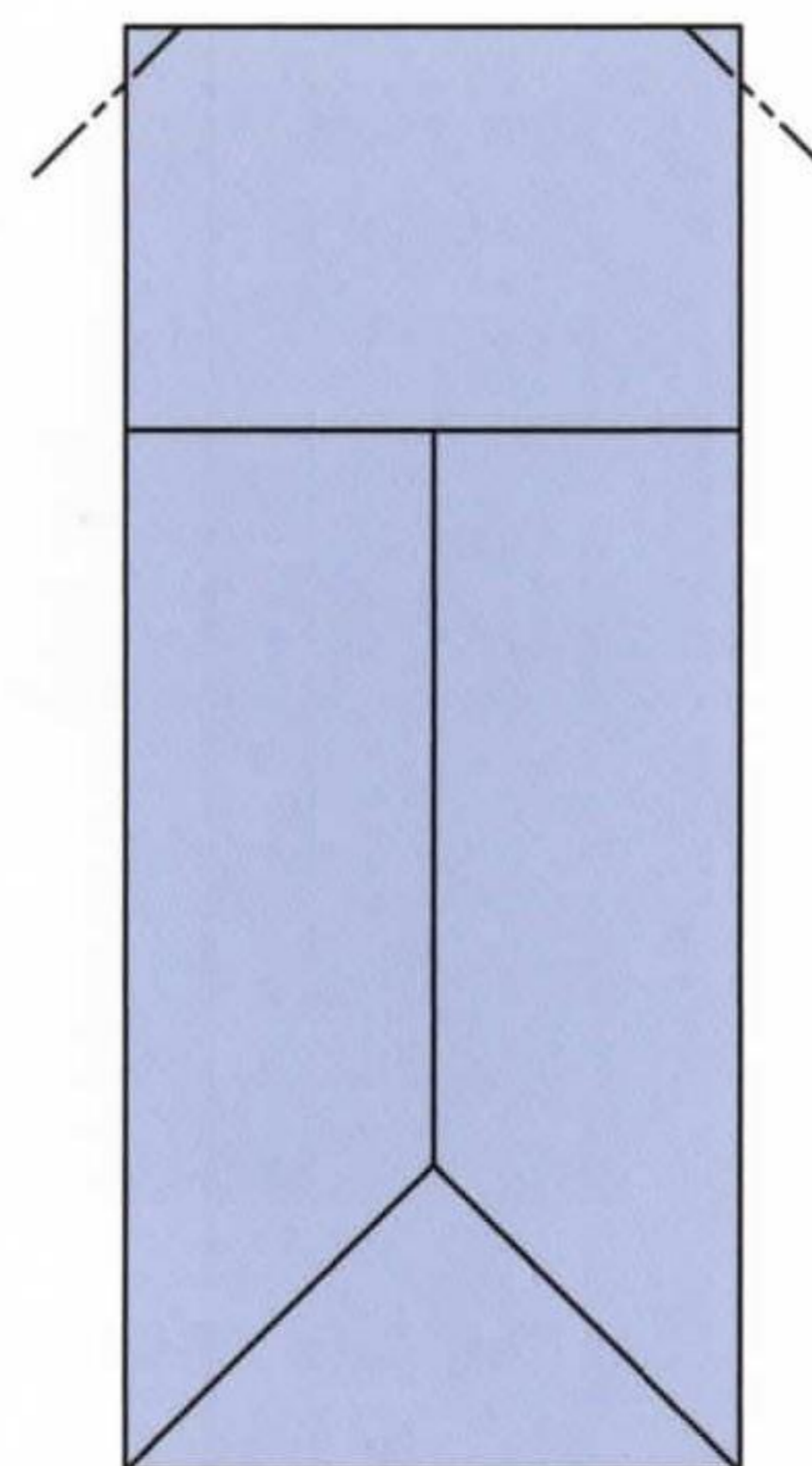

7. Inside reverse folds

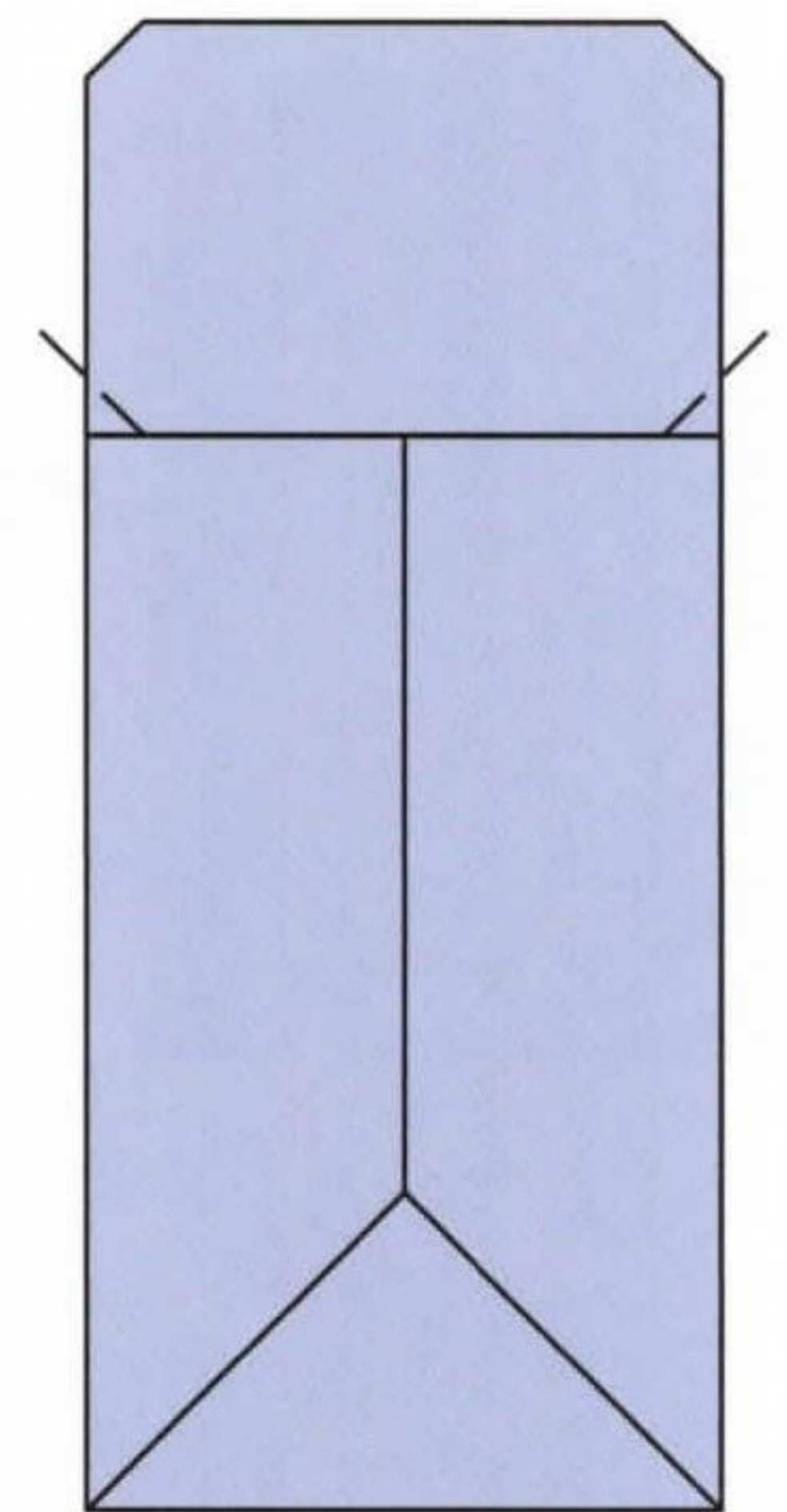

8. Valley folds

computer

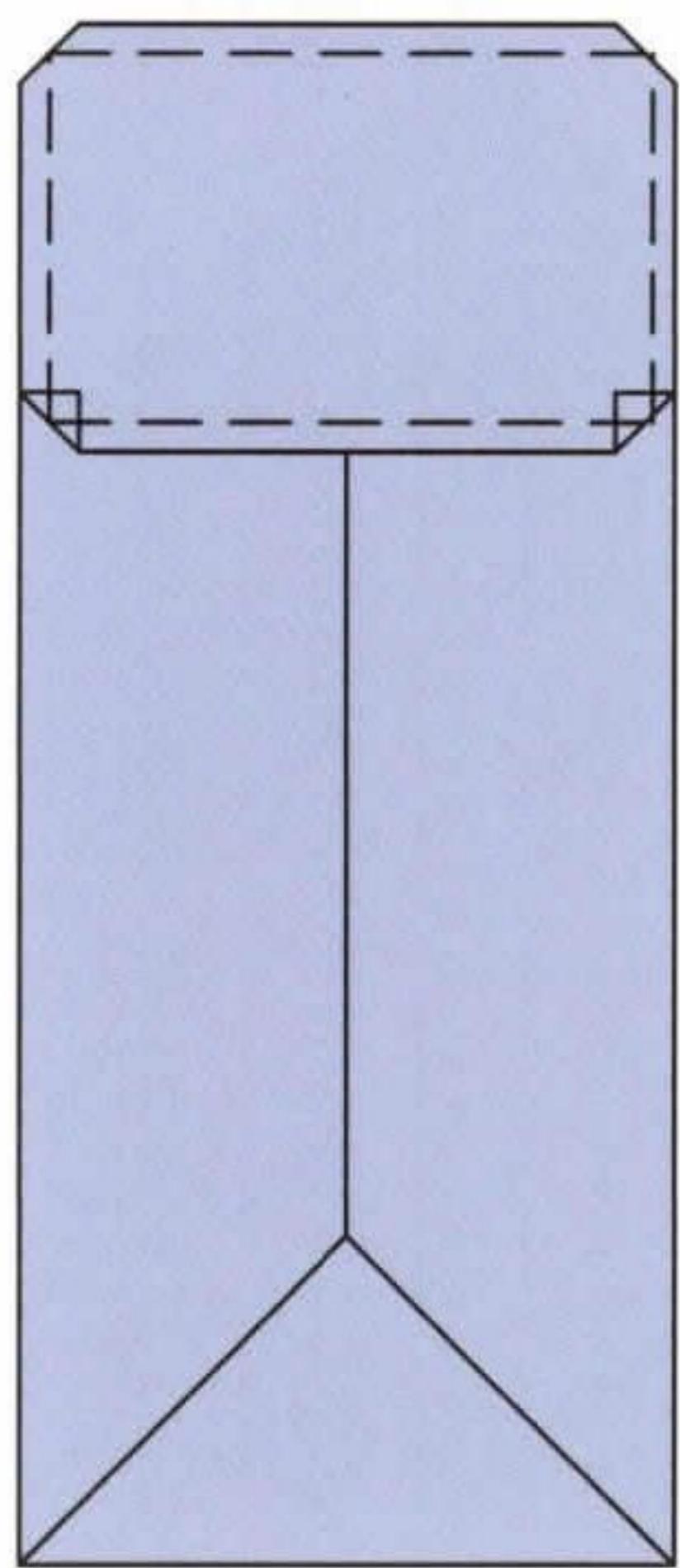

9. Valley folds

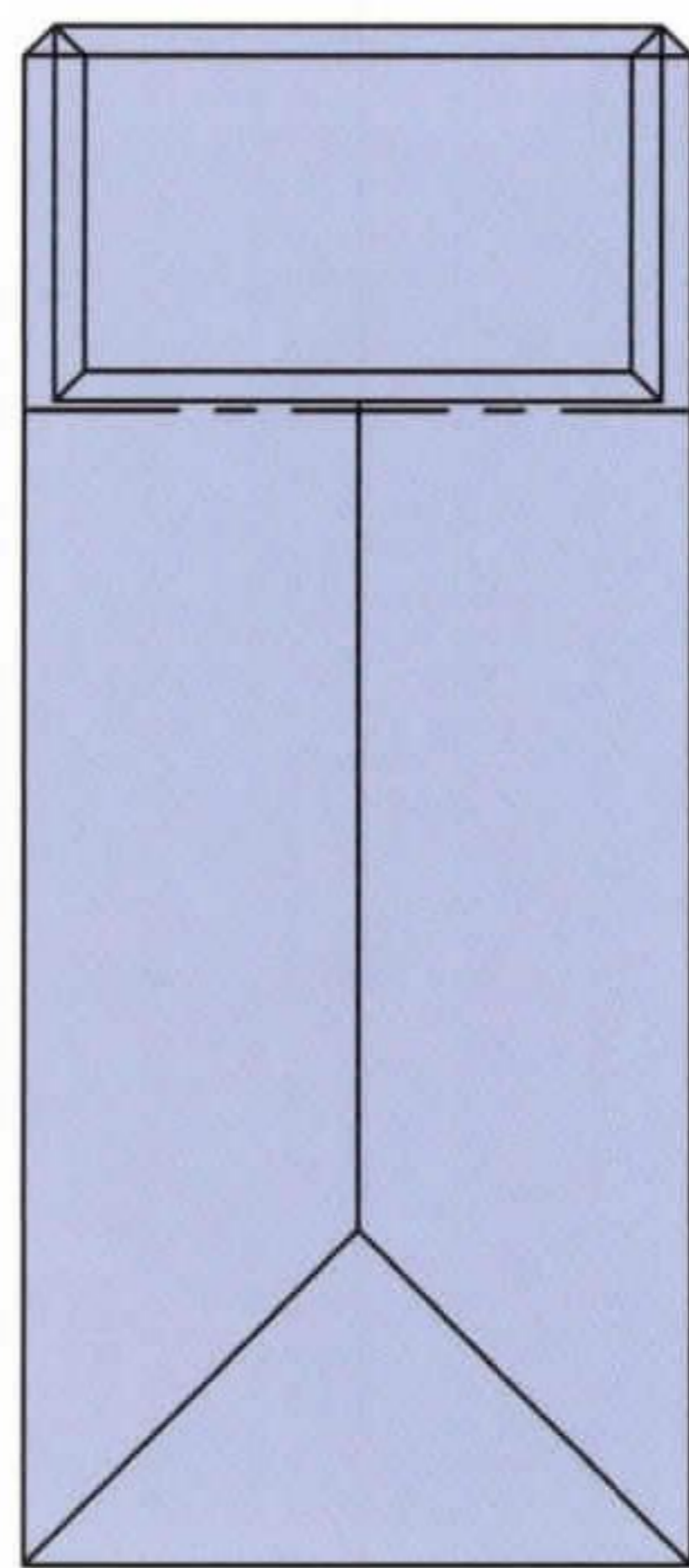

10. Mountain fold

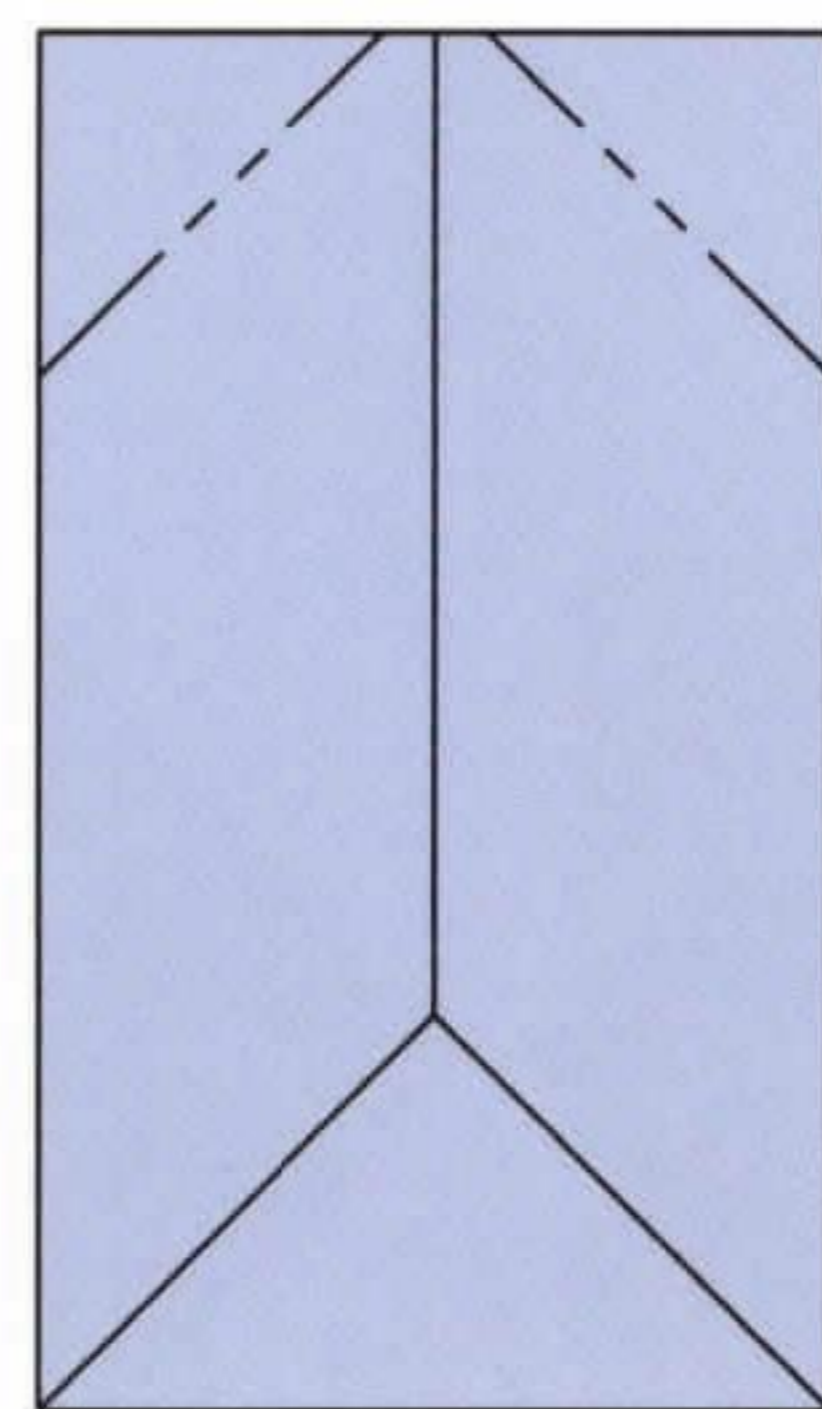

11. Inside reverse folds

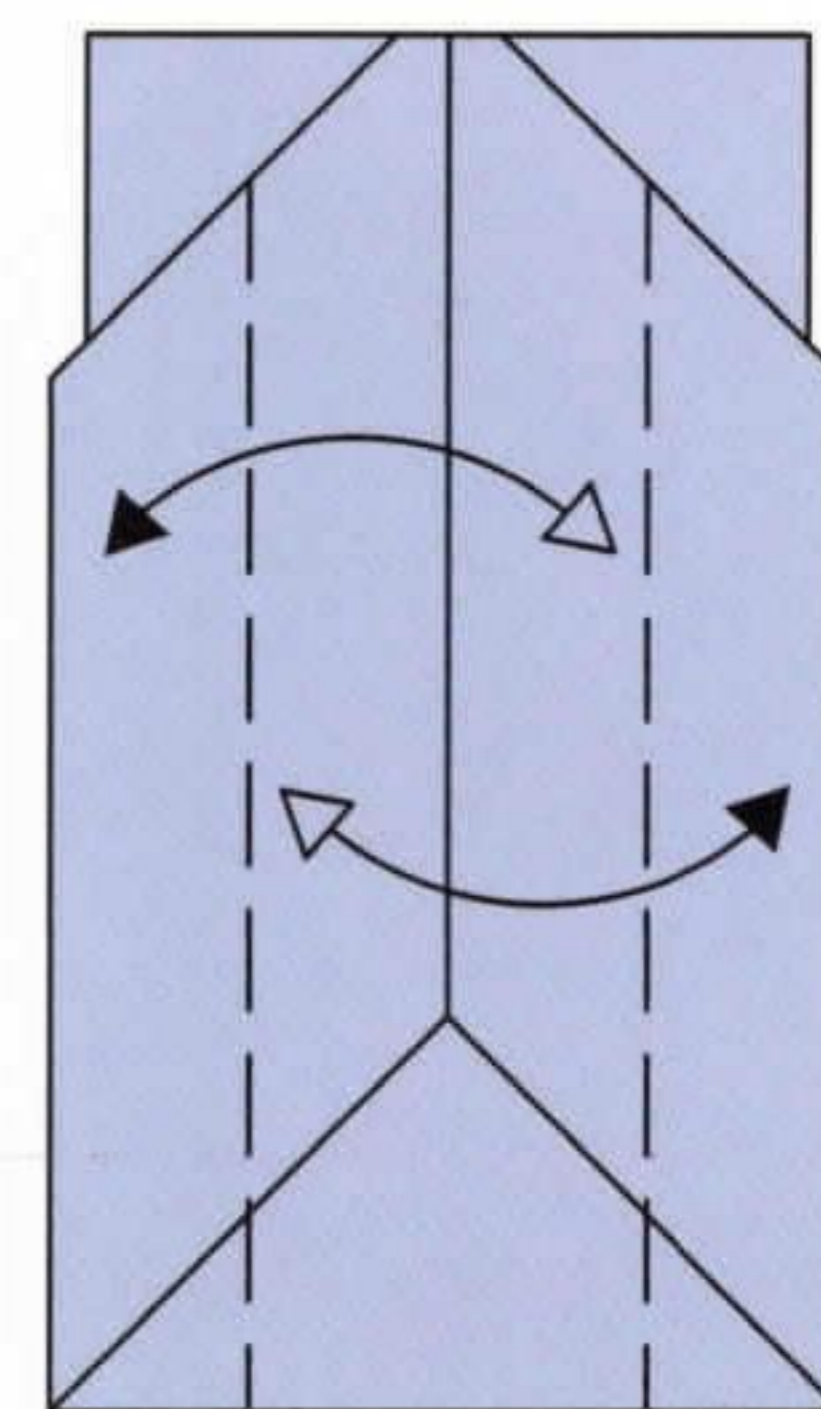

12. Valley fold and unfold

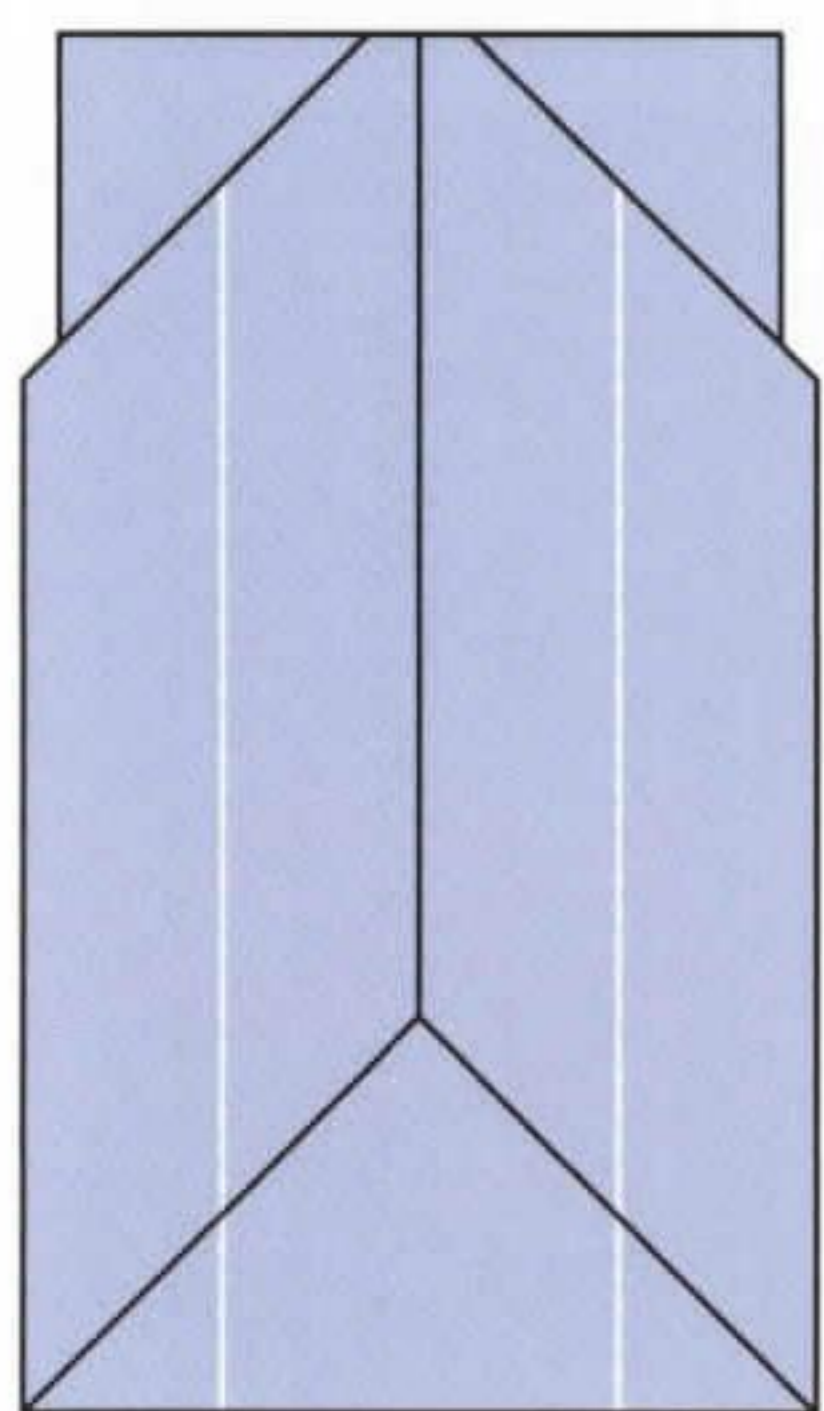

13. Turn over

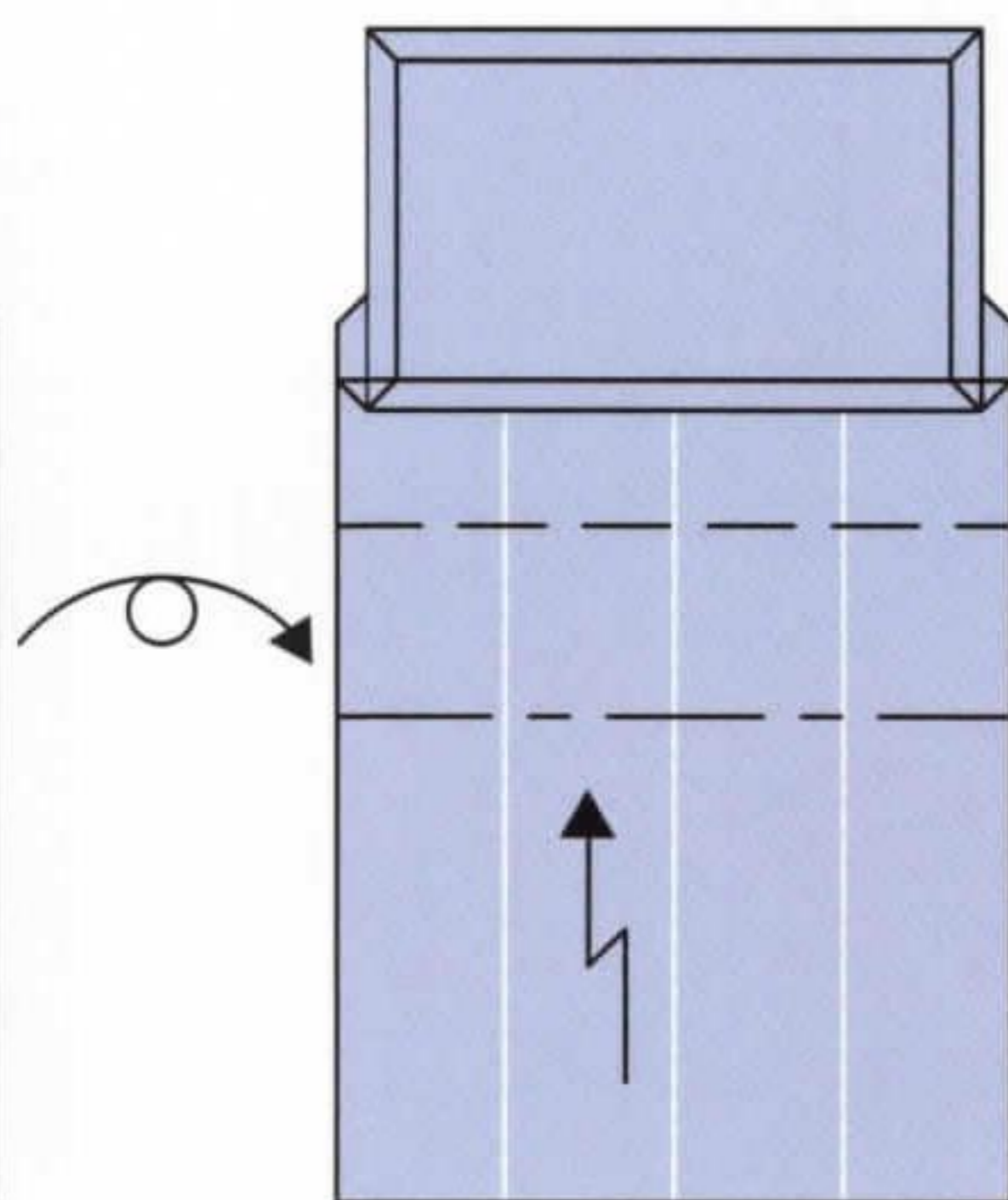

14. Pleat fold

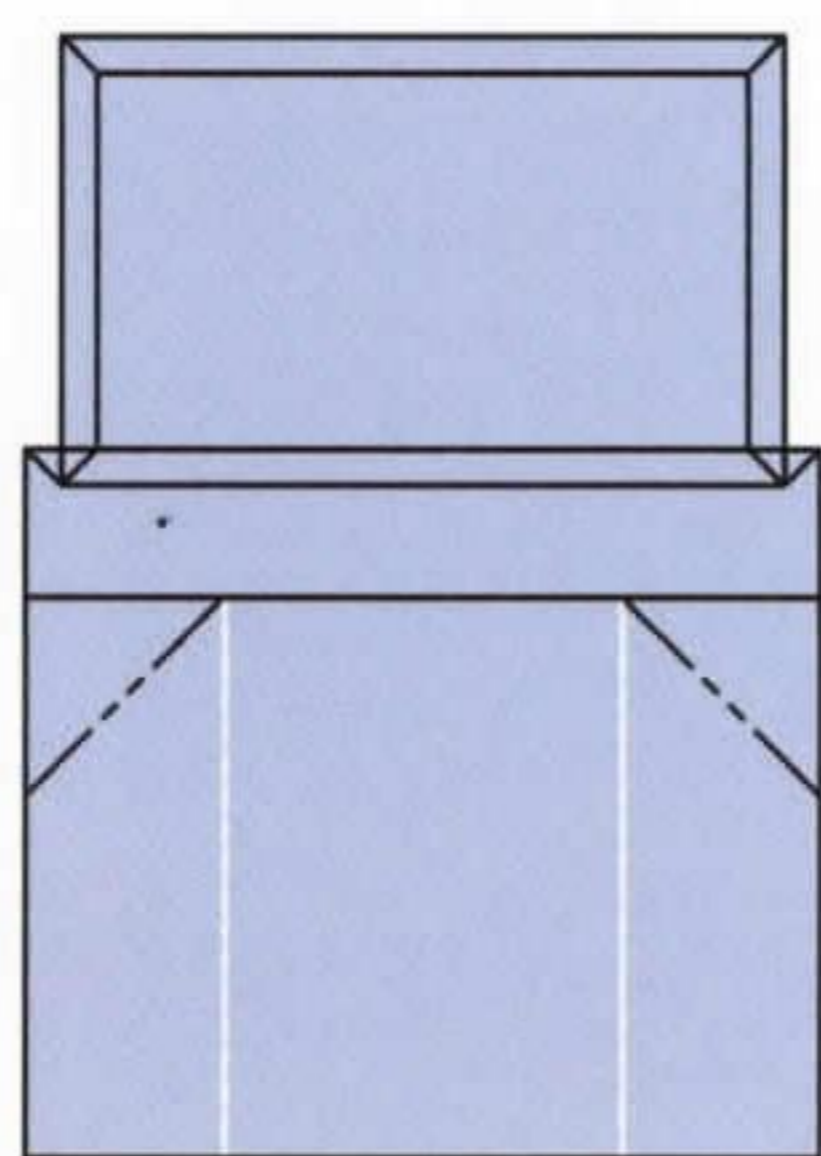

15. Inside reverse folds

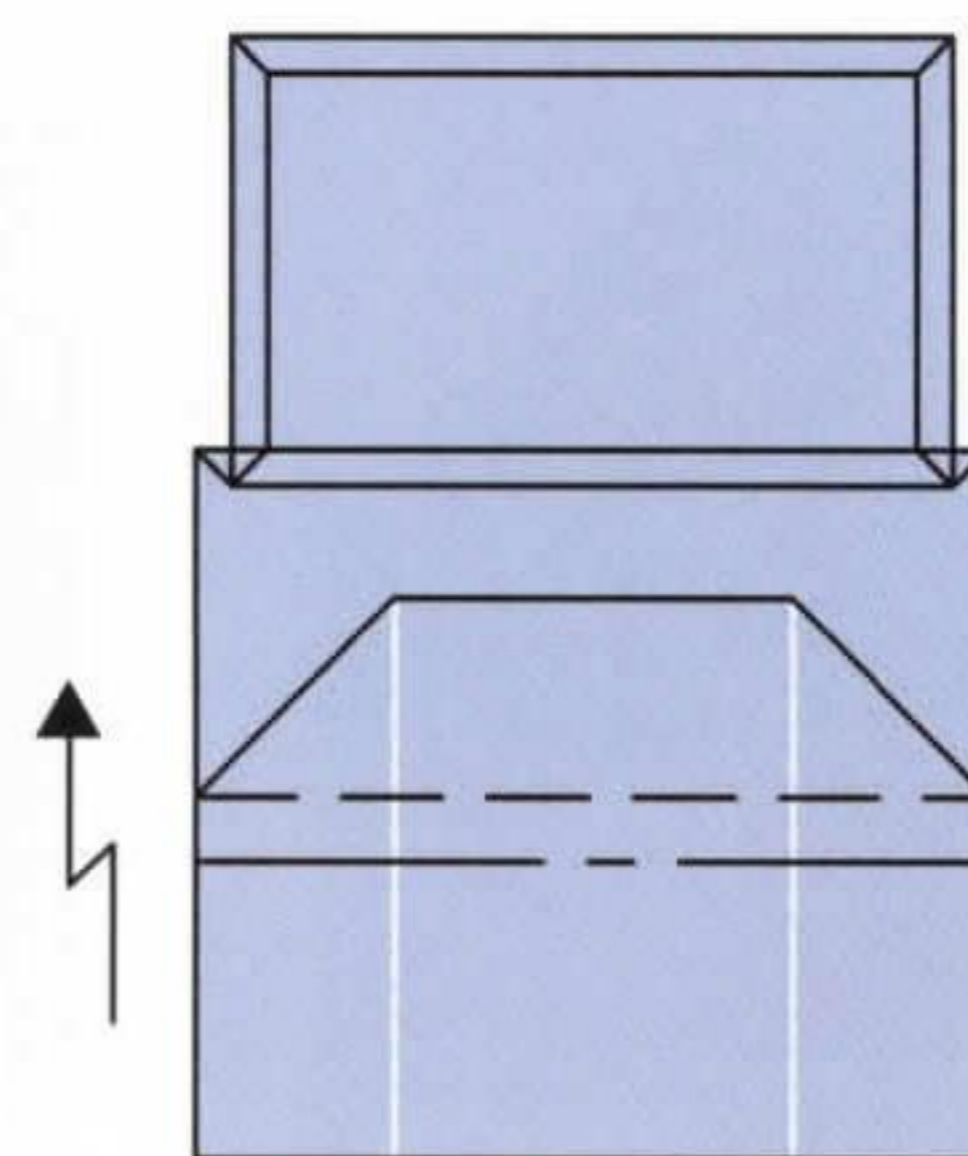

16. Pleat fold

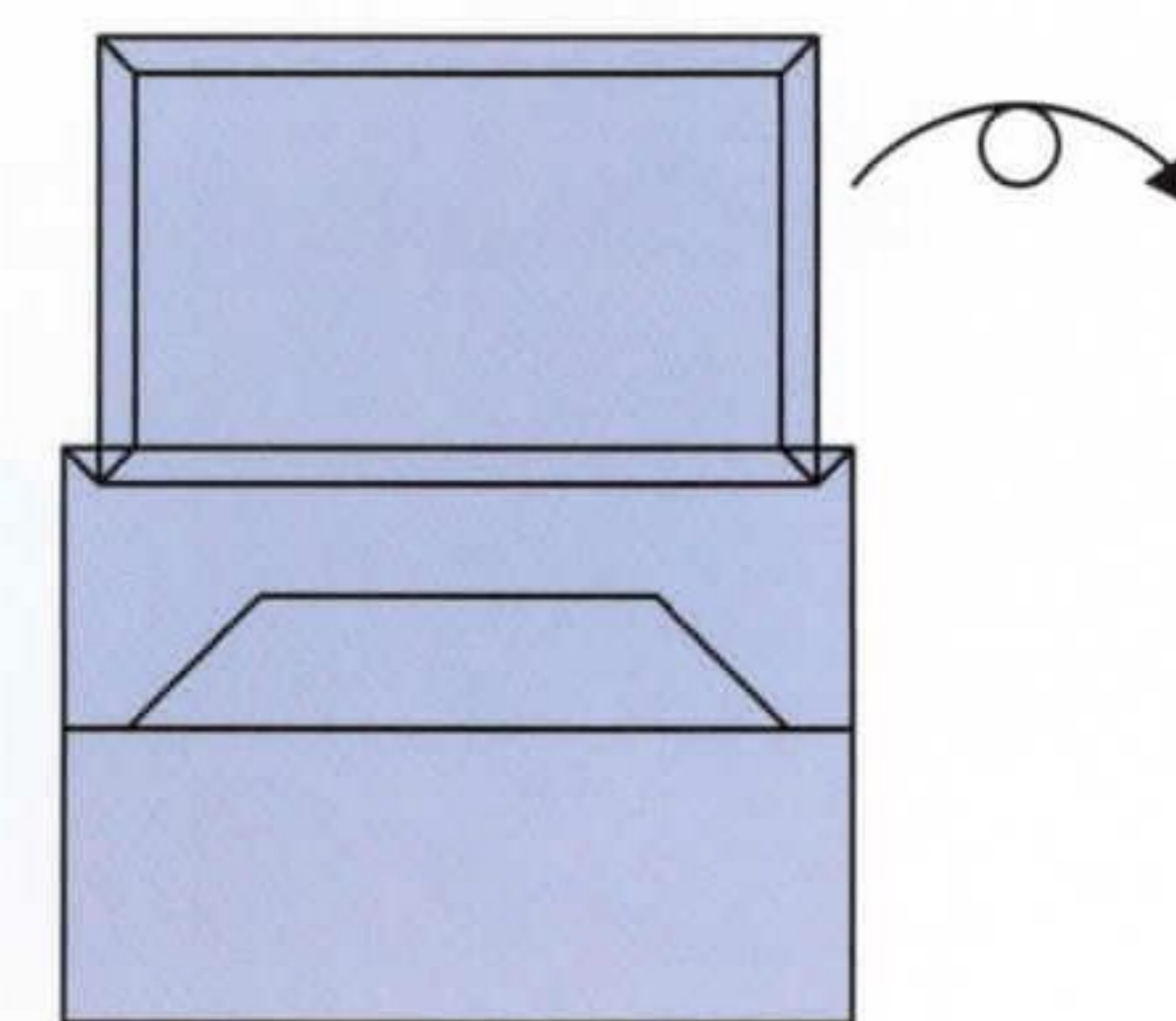

17. Turn over

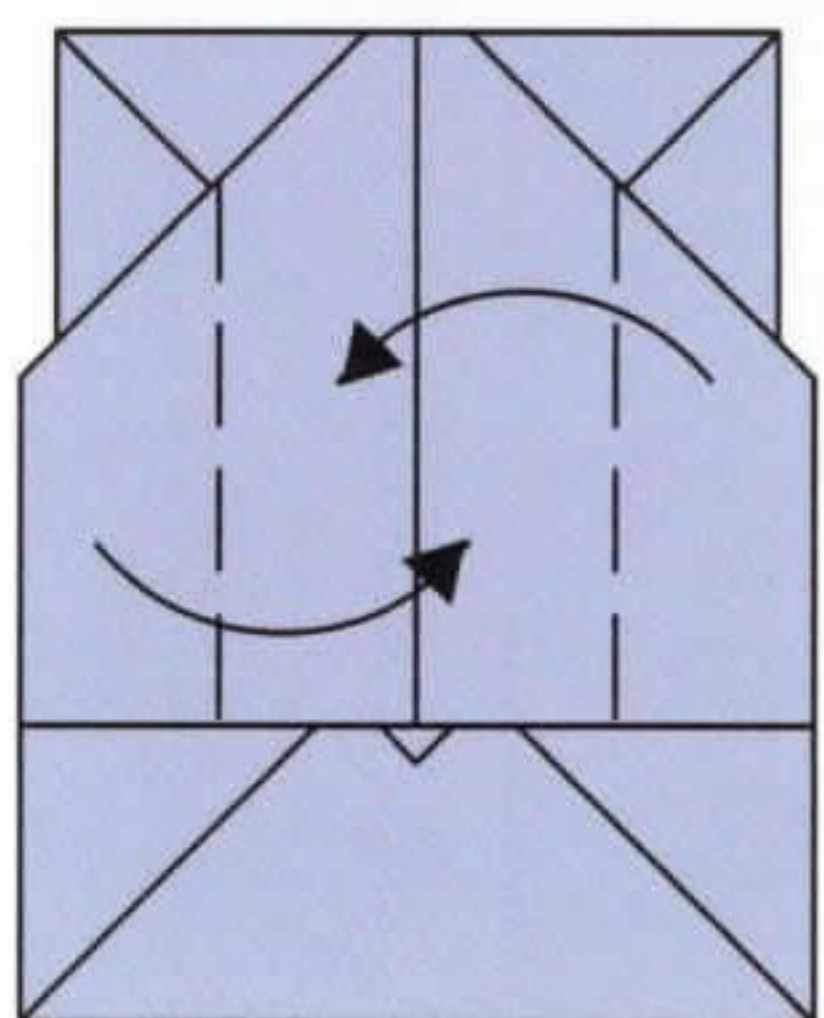

18. Valley folds

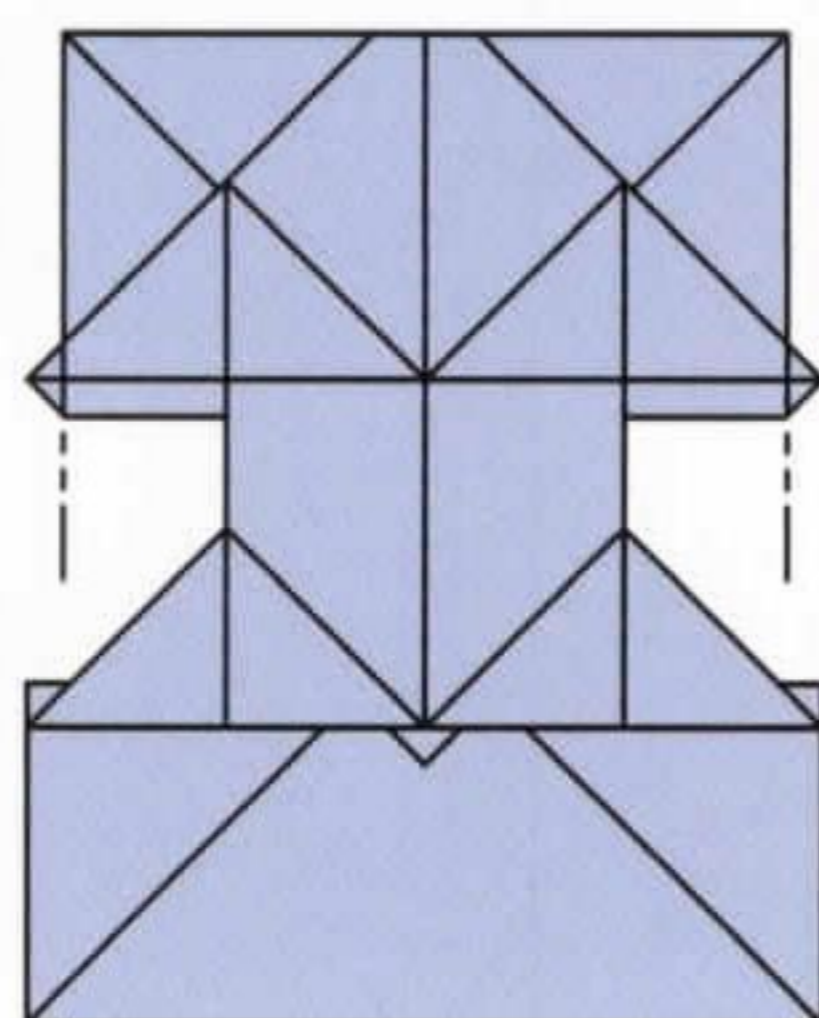

19. Inside reverse folds

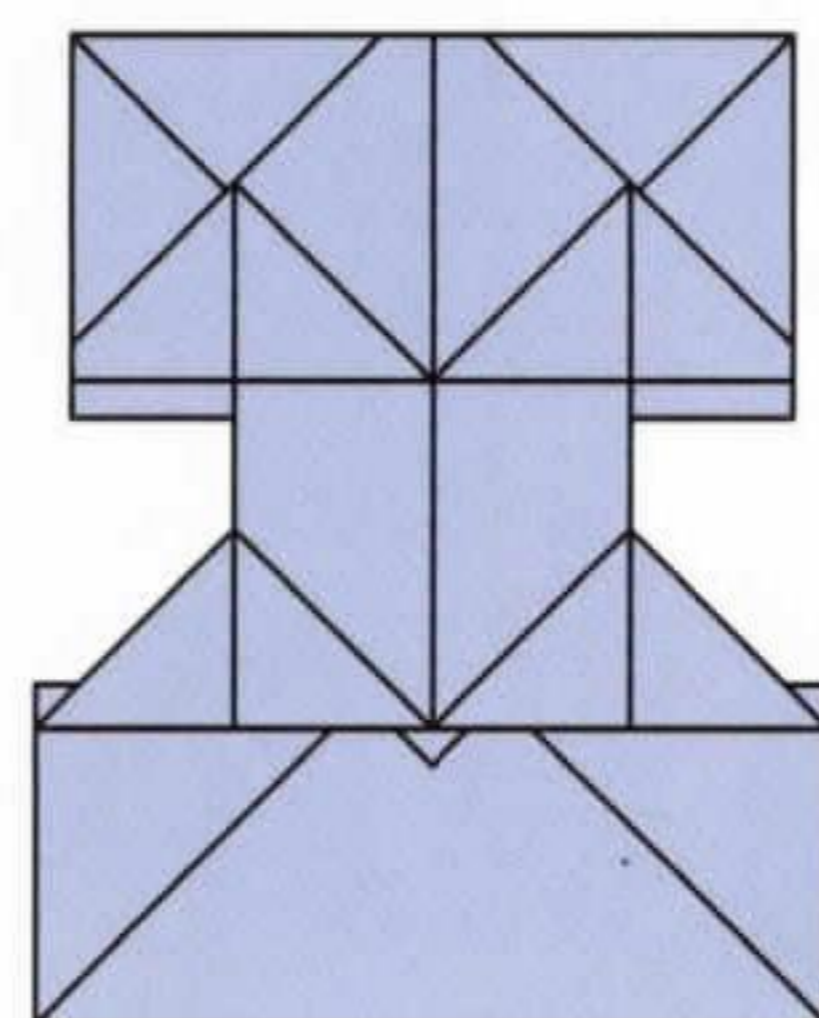

20. Turn over

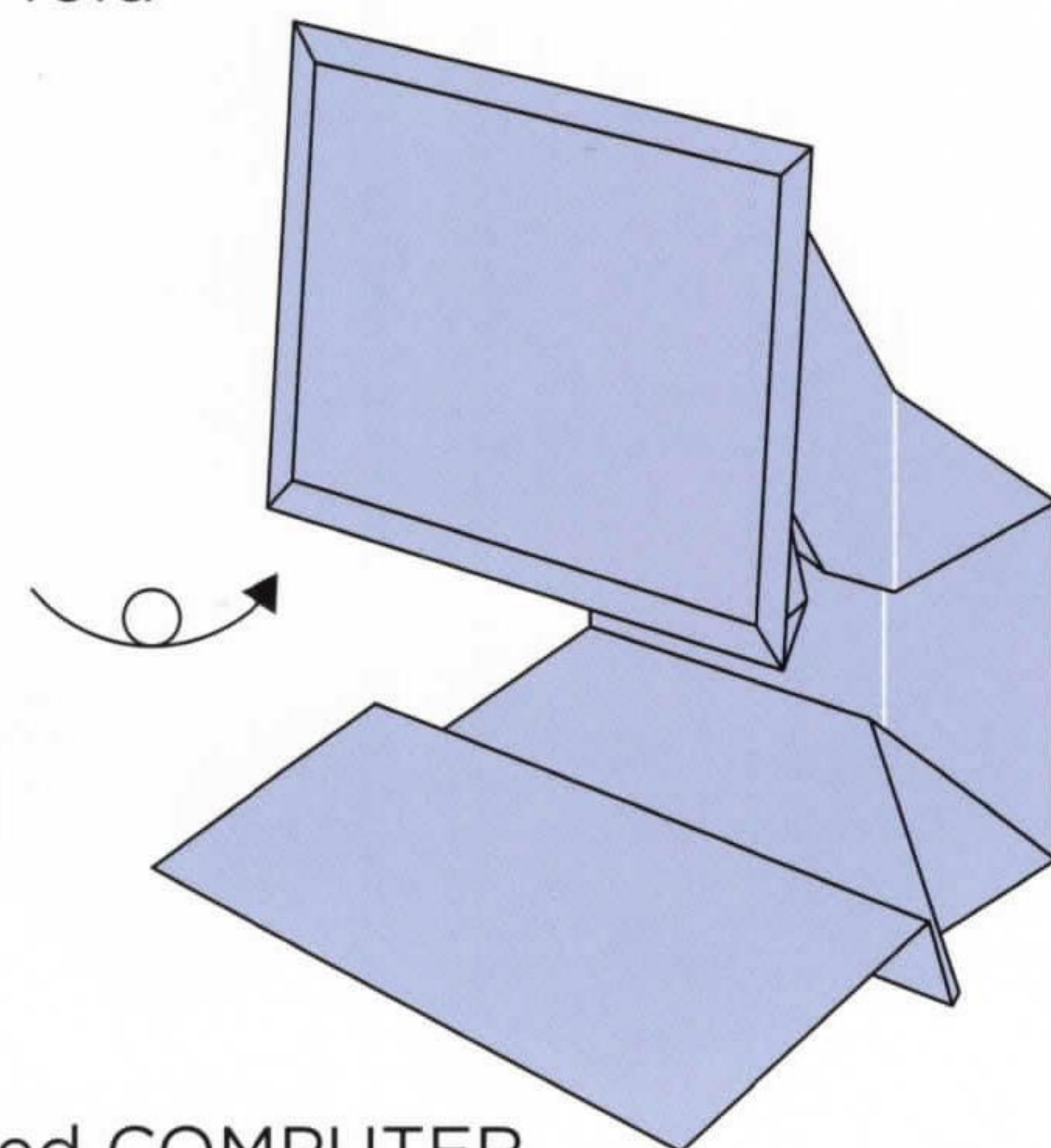

21. Completed COMPUTER

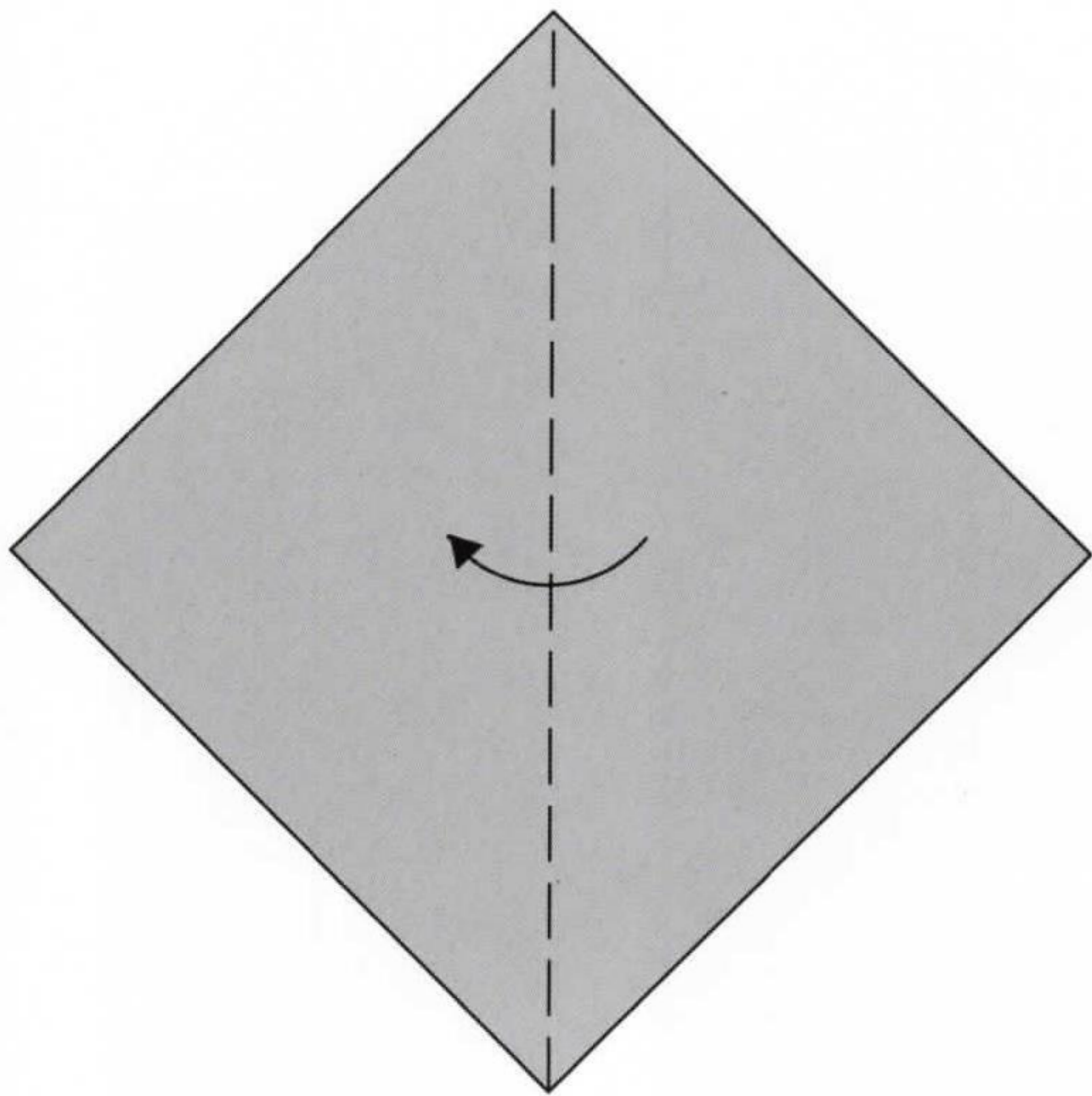

1. Valley fold

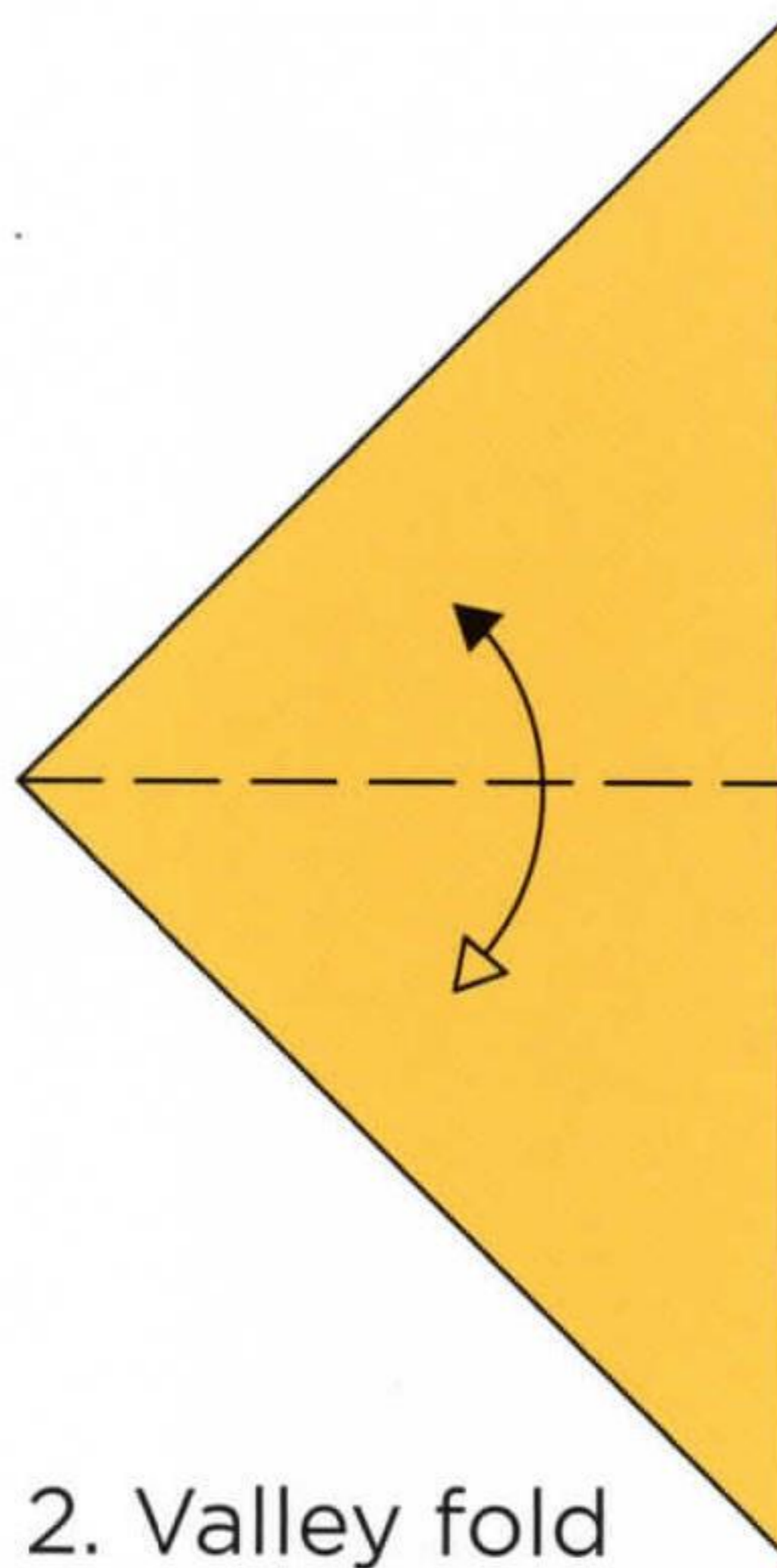

2. Valley fold and unfold

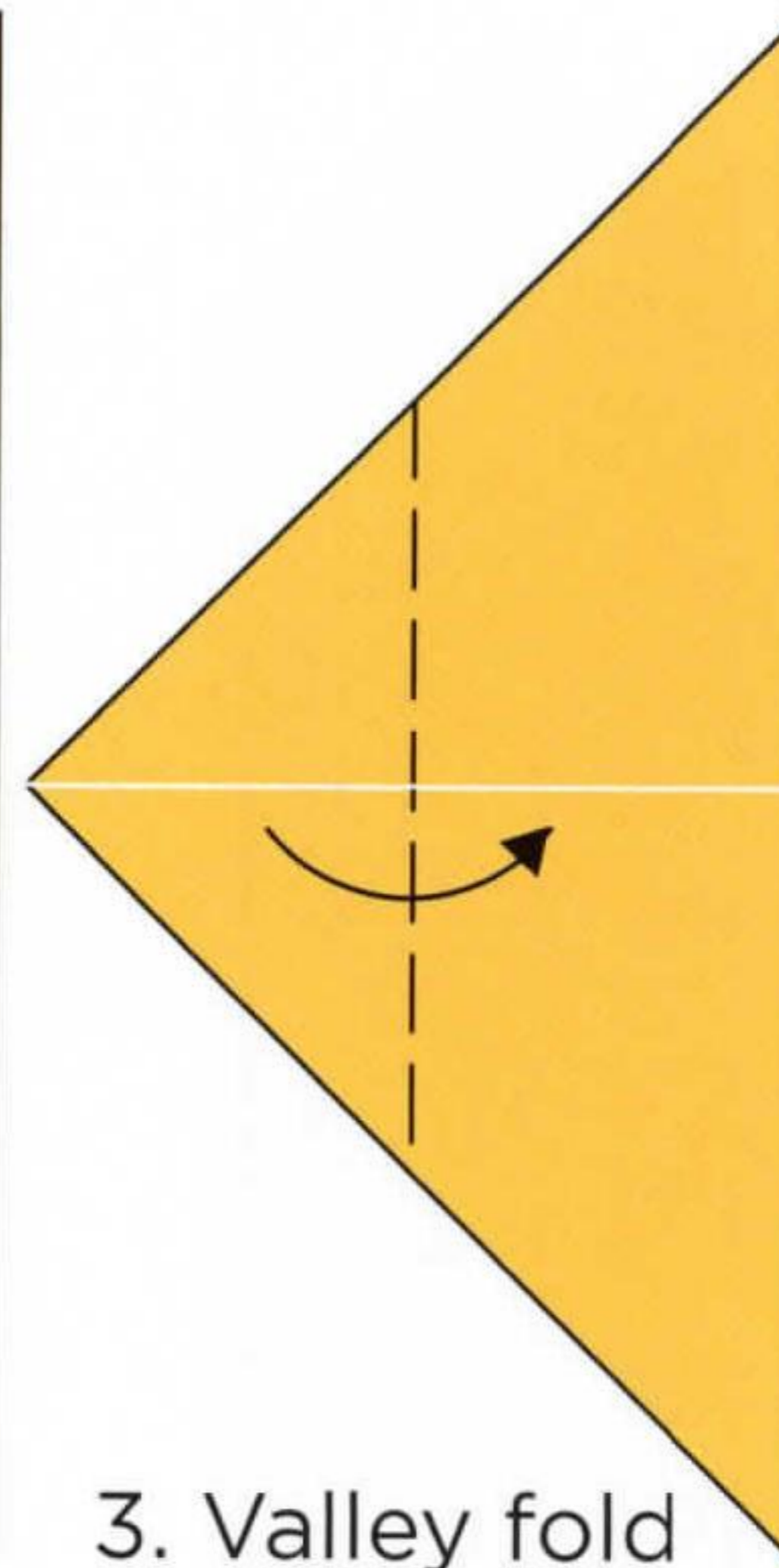

3. Valley fold

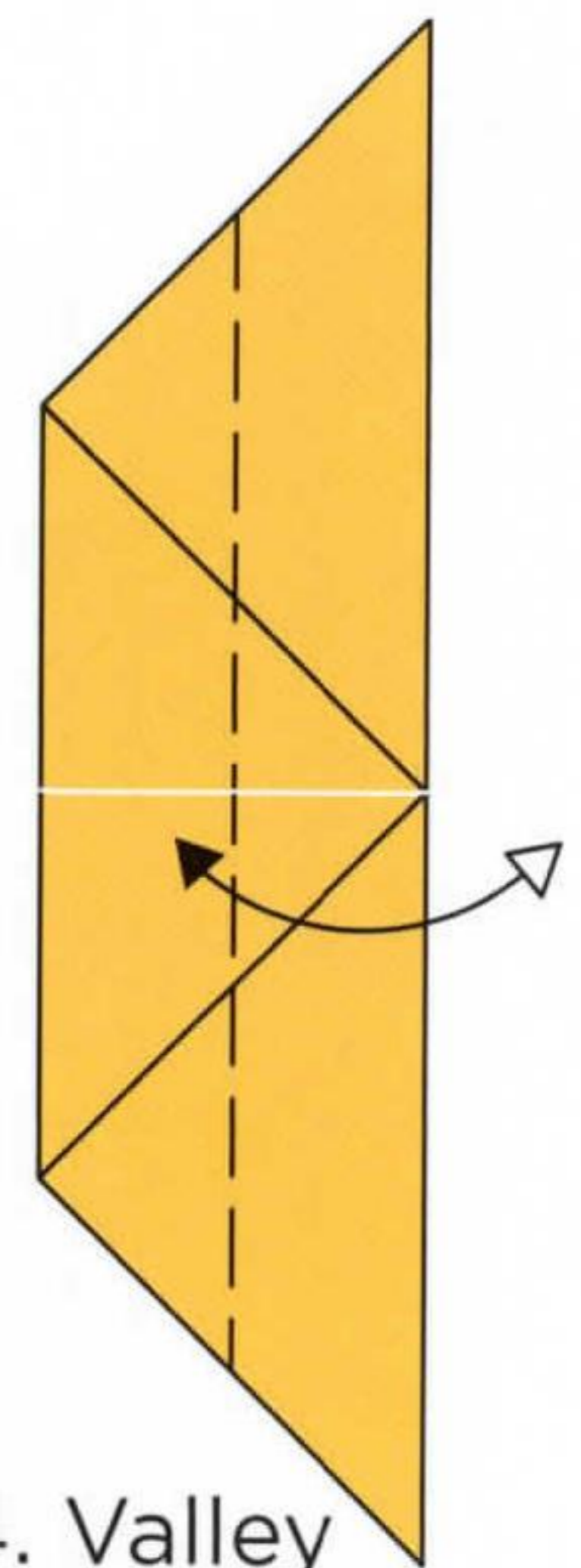

4. Valley fold and unfold

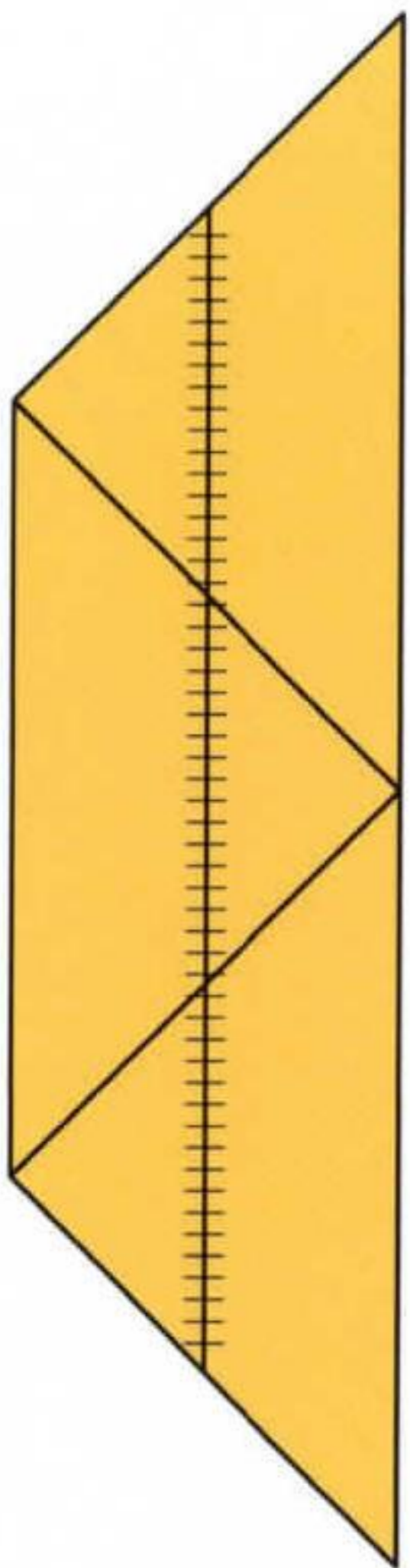

5. Cut as shown

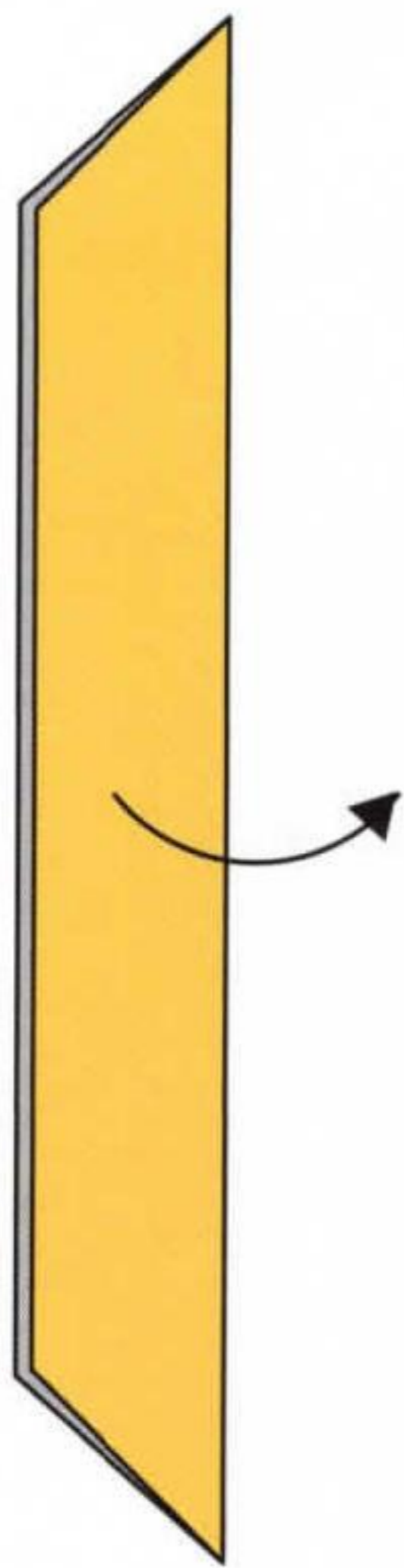

6. Valley fold

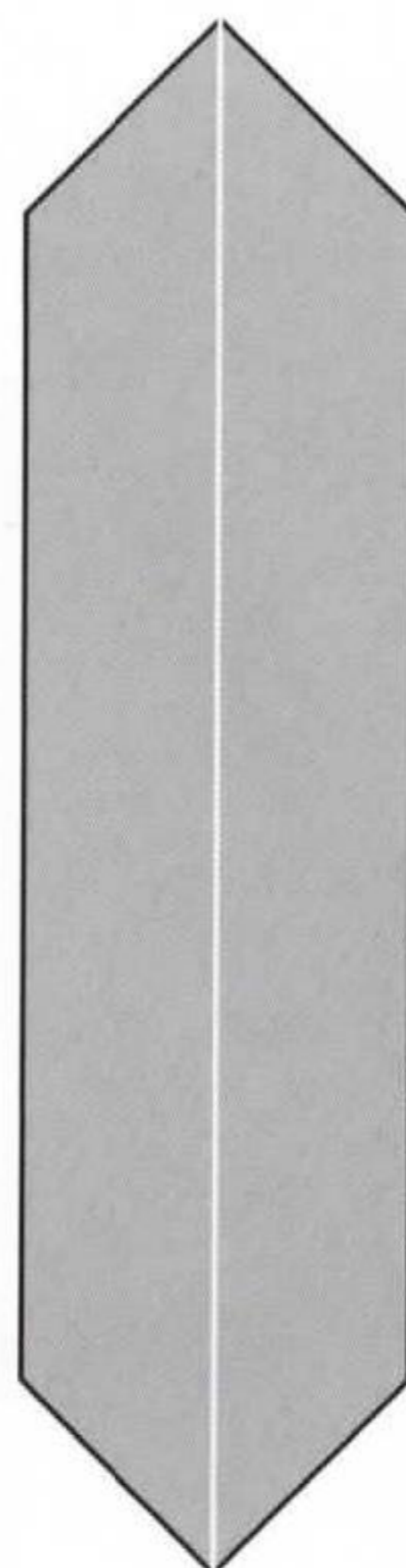

7. Scale-up

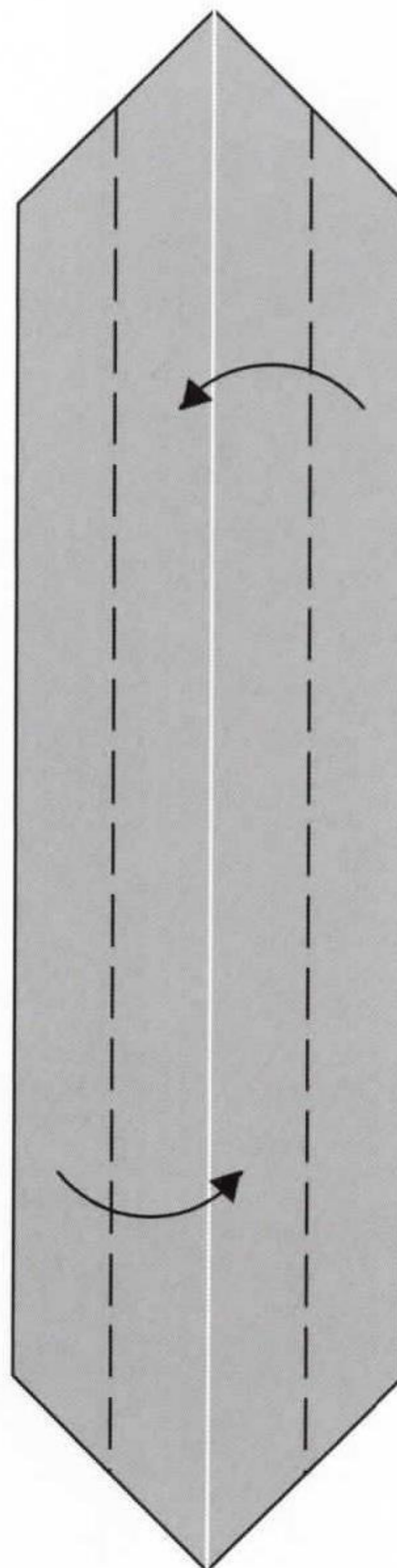

8. Valley folds

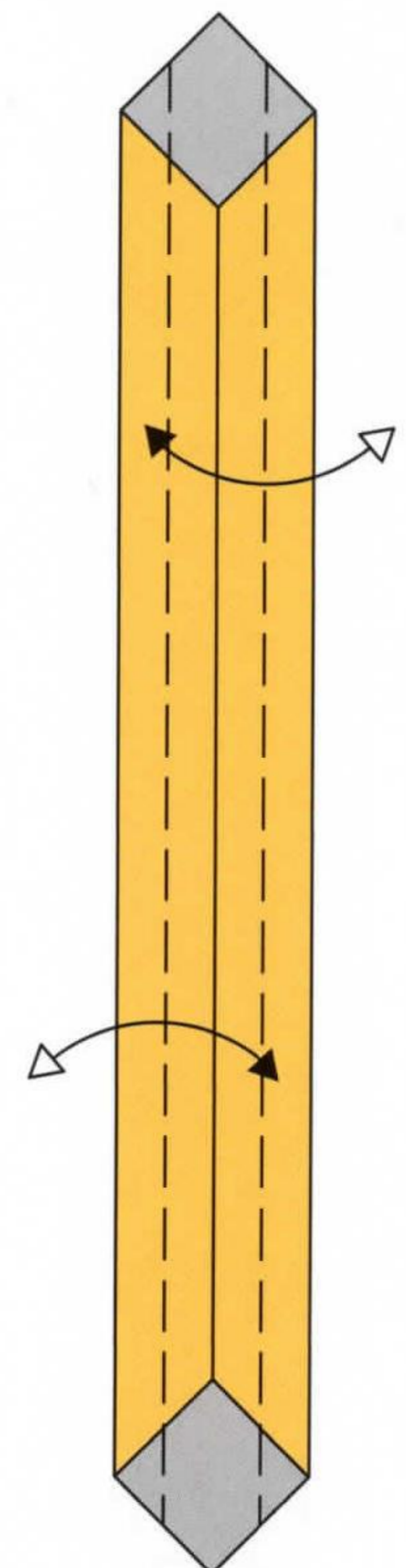

9. Valley folds and unfold

floor lamp

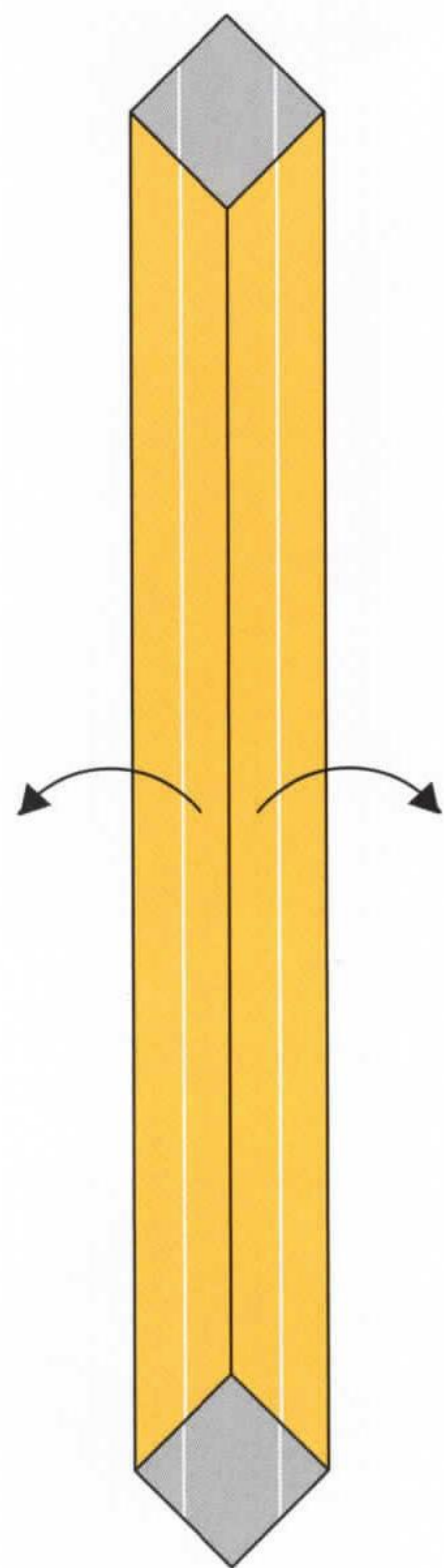

10. Valley folds

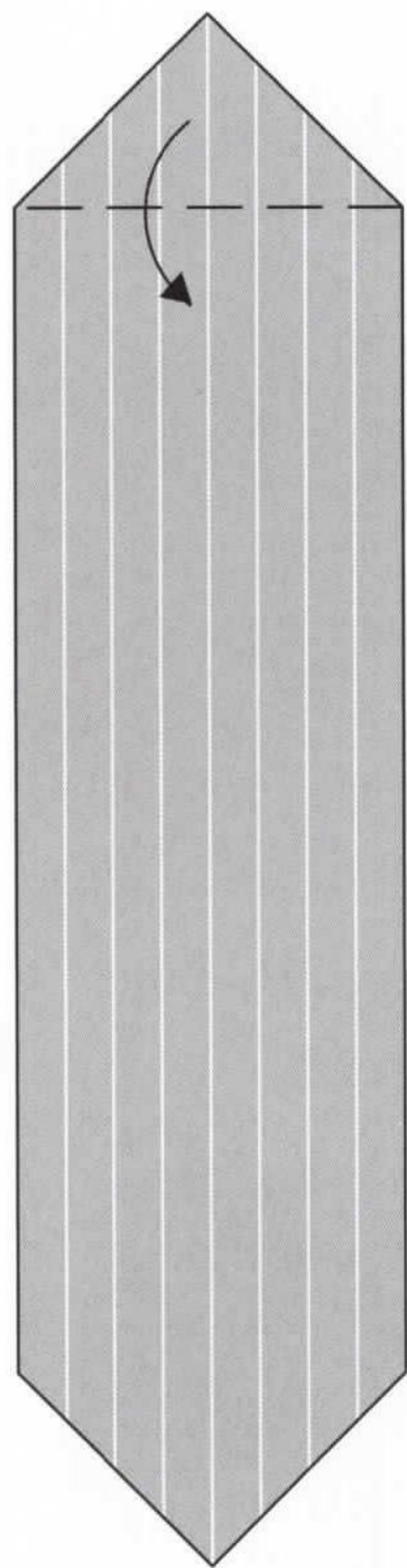

11. Valley fold

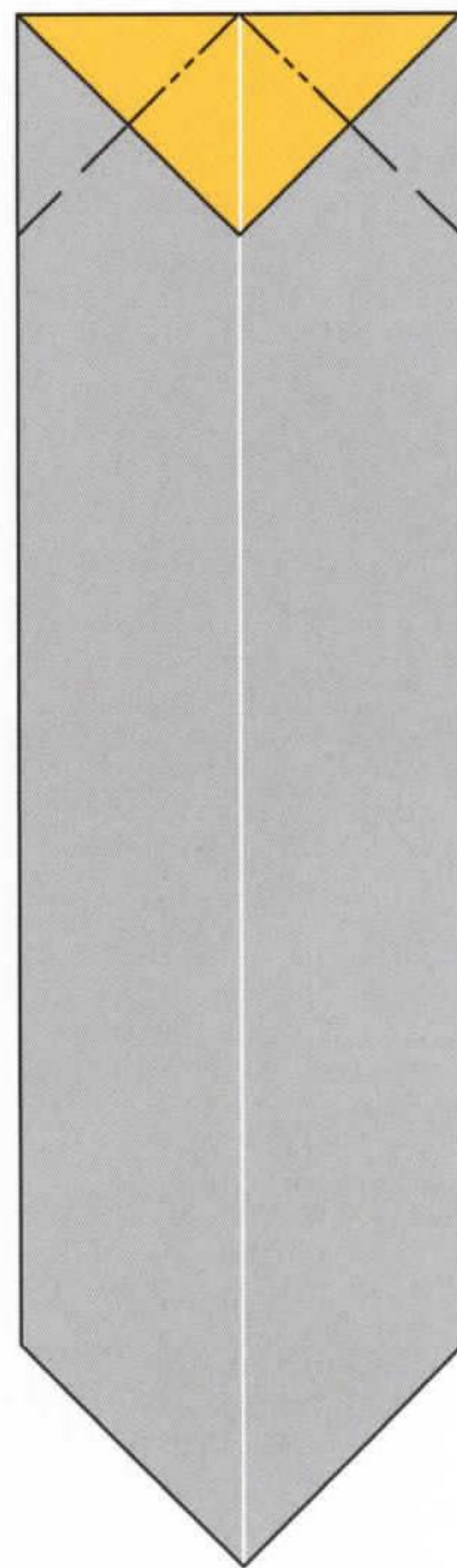

12. Inside reverse folds

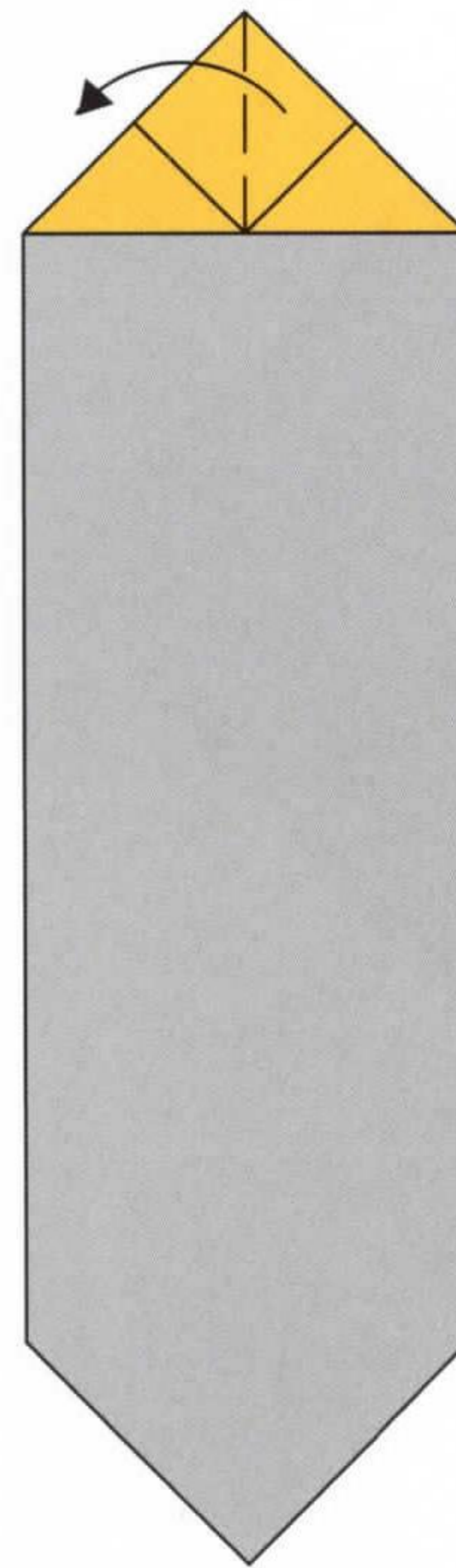

13. Valley fold

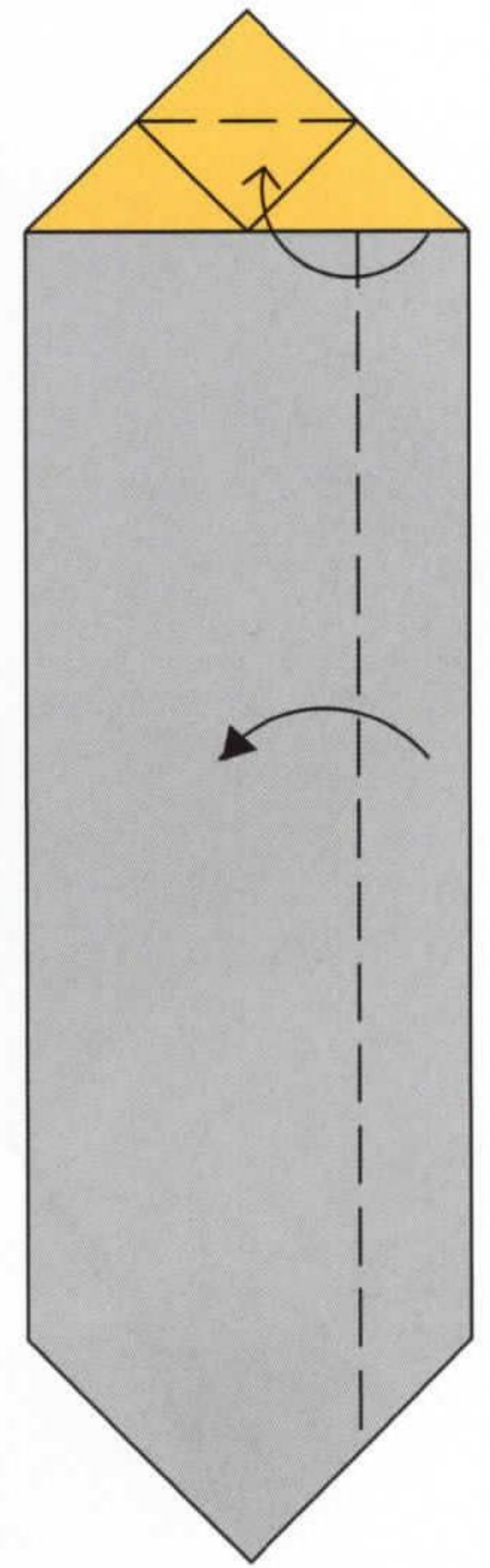

14. Squash fold

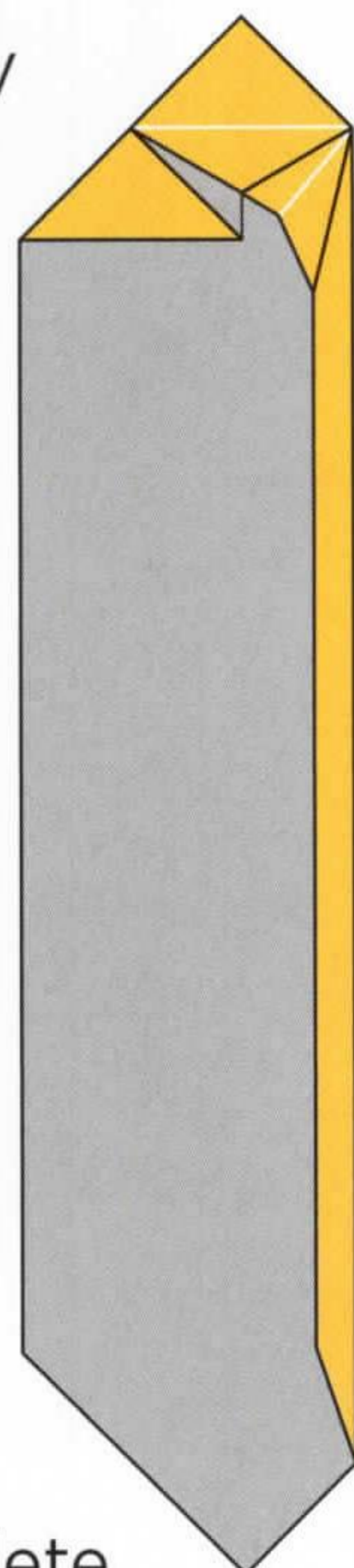

15. Almost complete

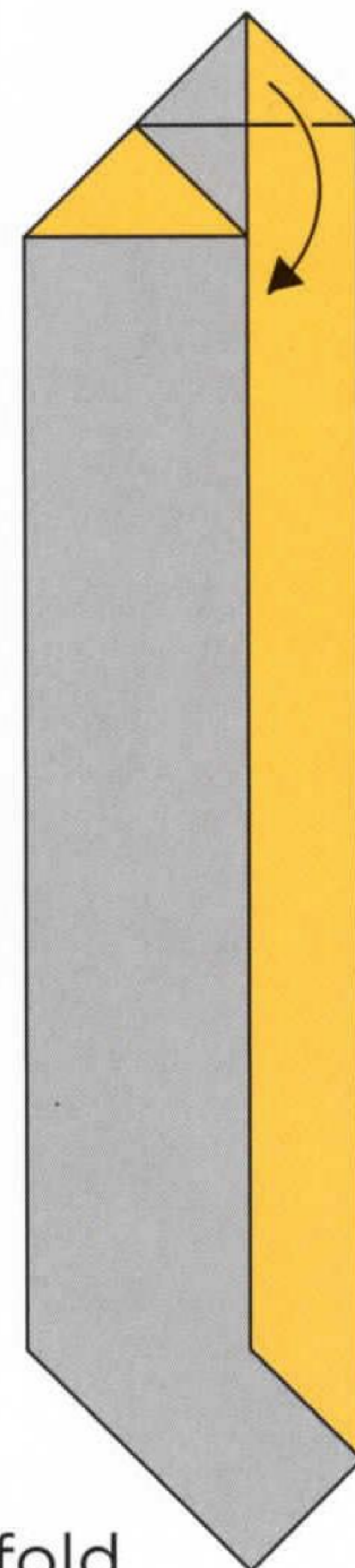

16. Valley fold

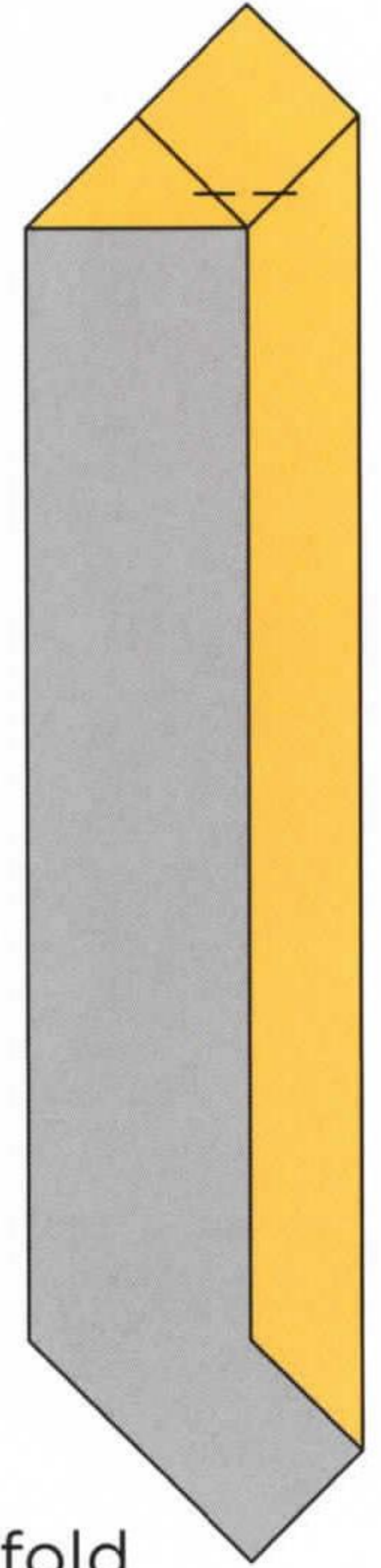

17. Valley fold

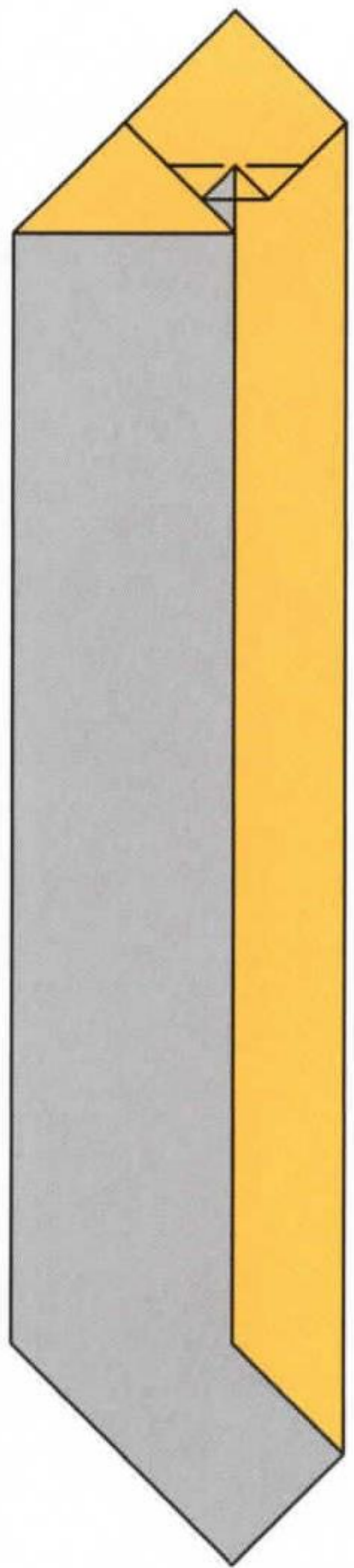

18. Valley fold

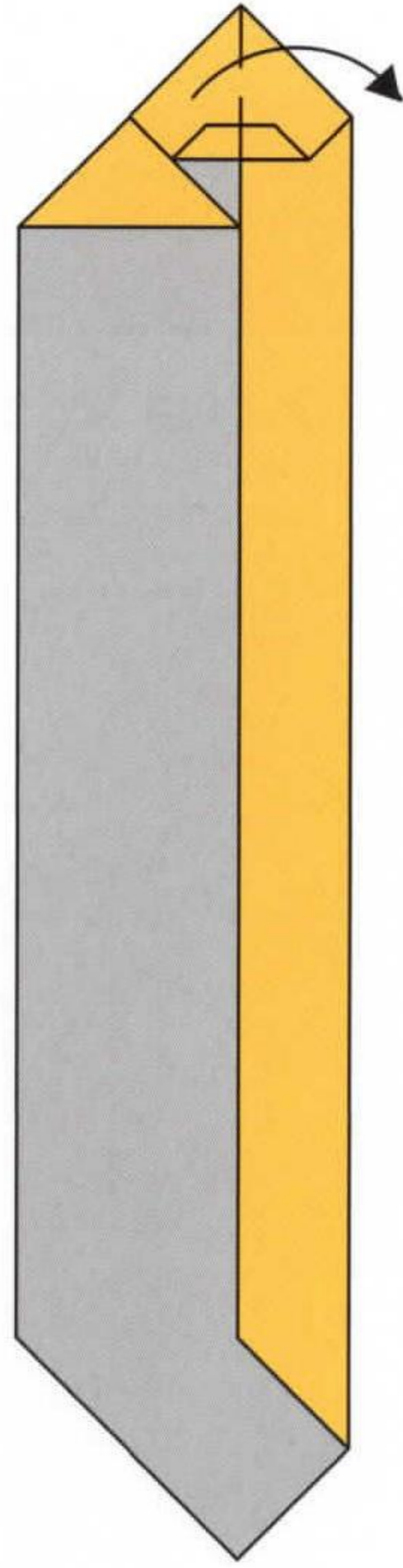

19. Valley fold

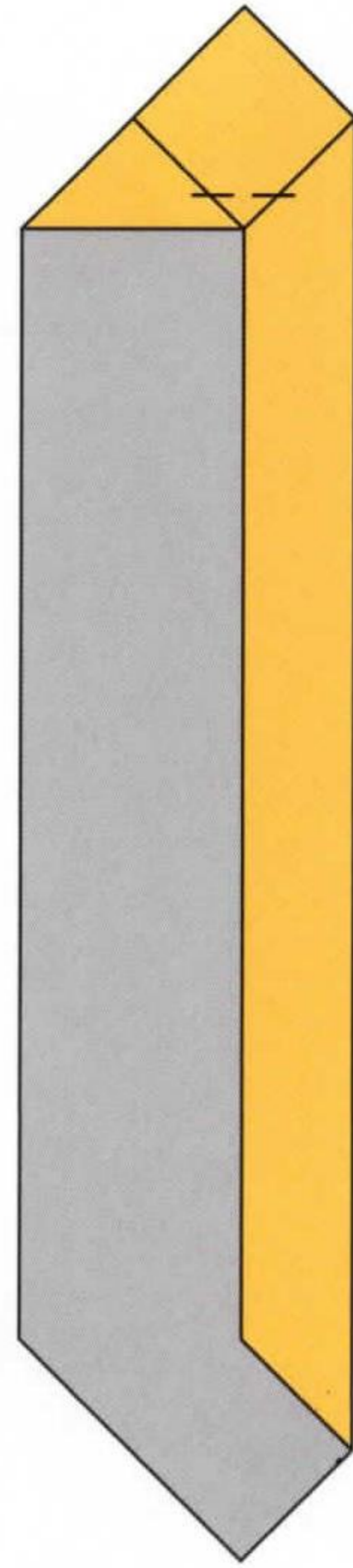

20. Valley fold

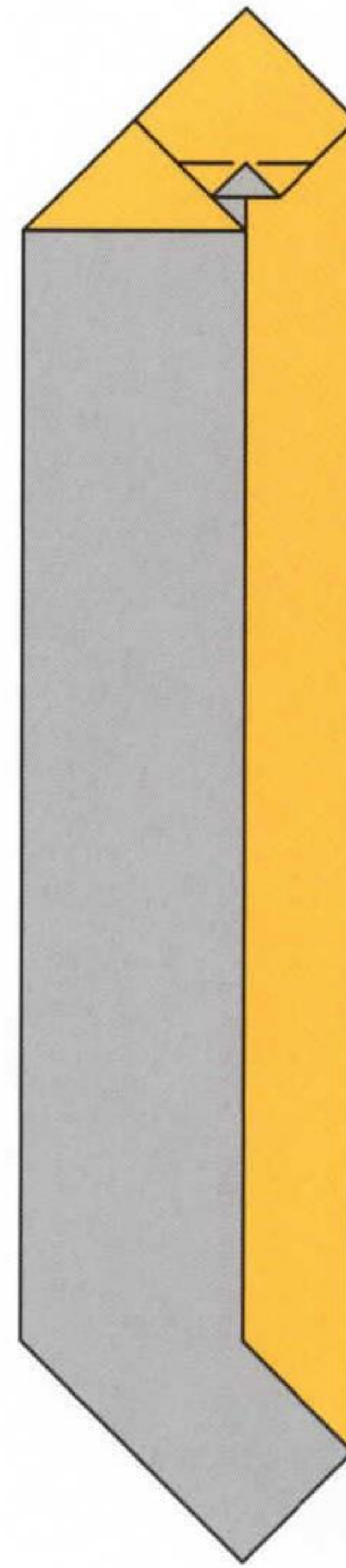

21. Valley fold

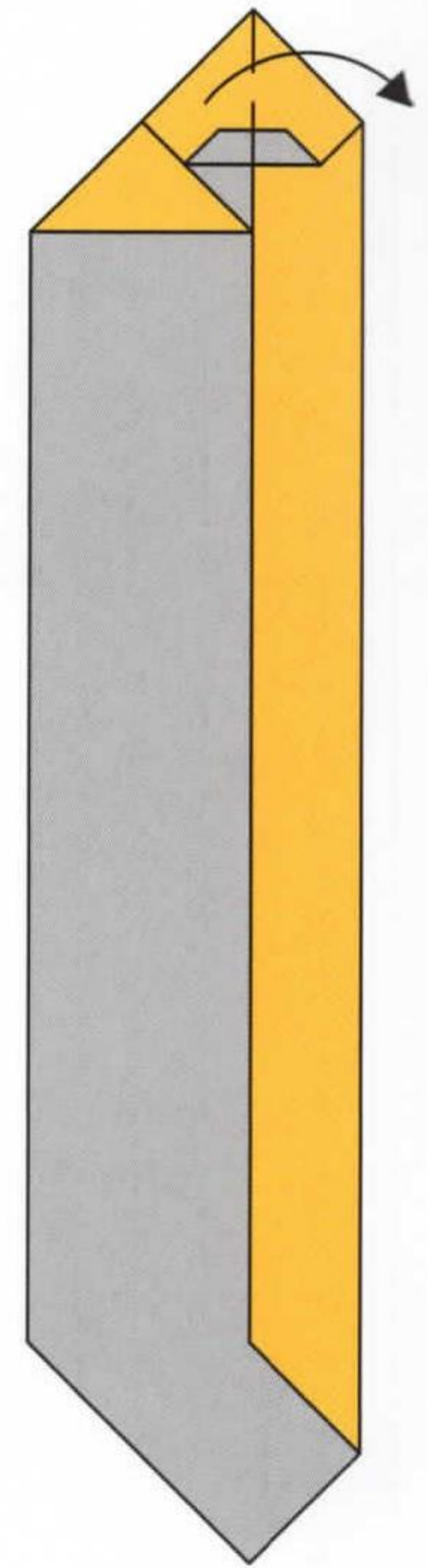

22. Valley fold

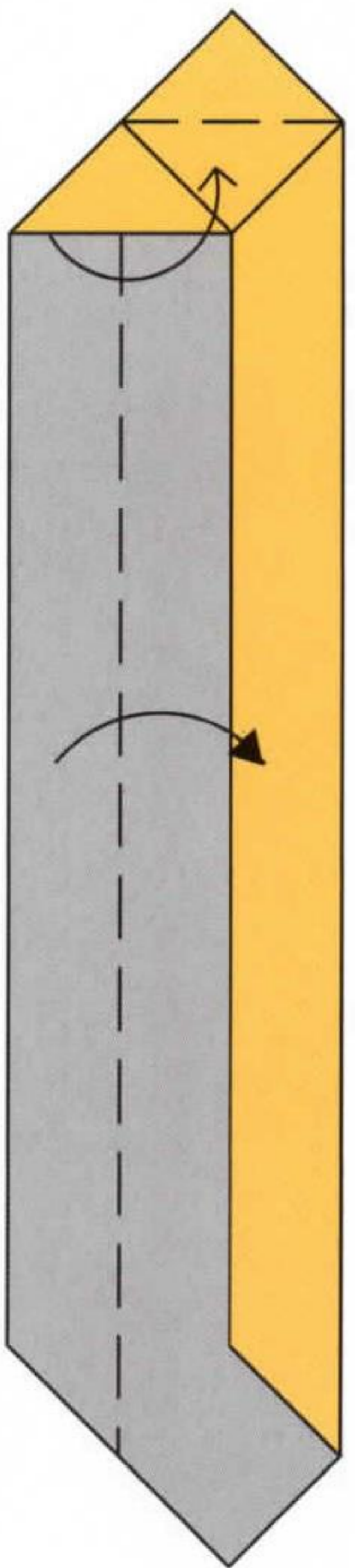

23. Squash fold

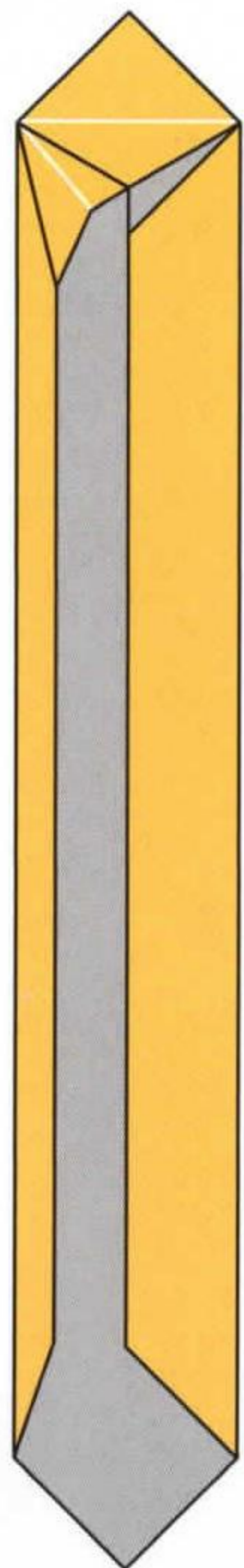

24. Before complete

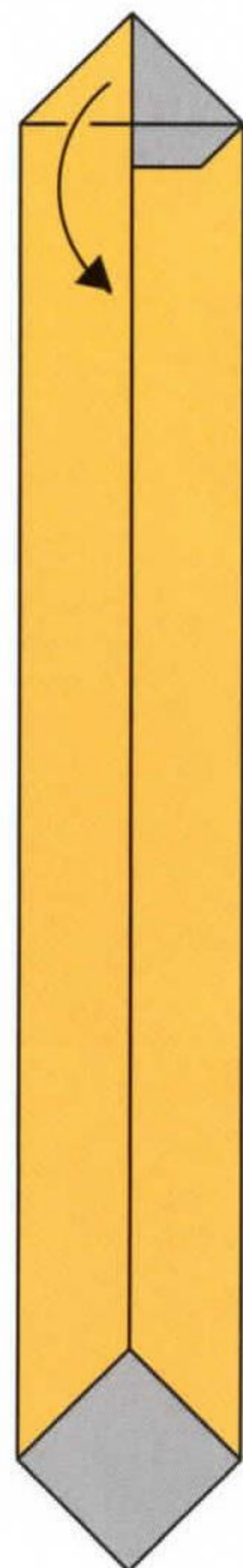

25. Valley fold

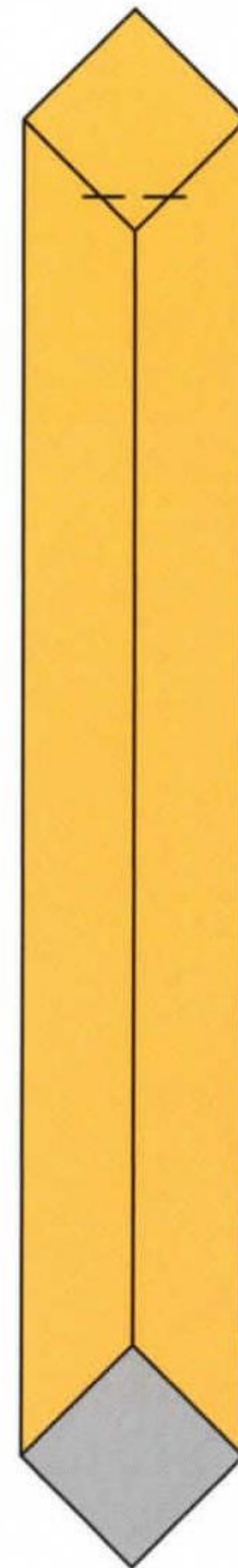

26. Valley fold

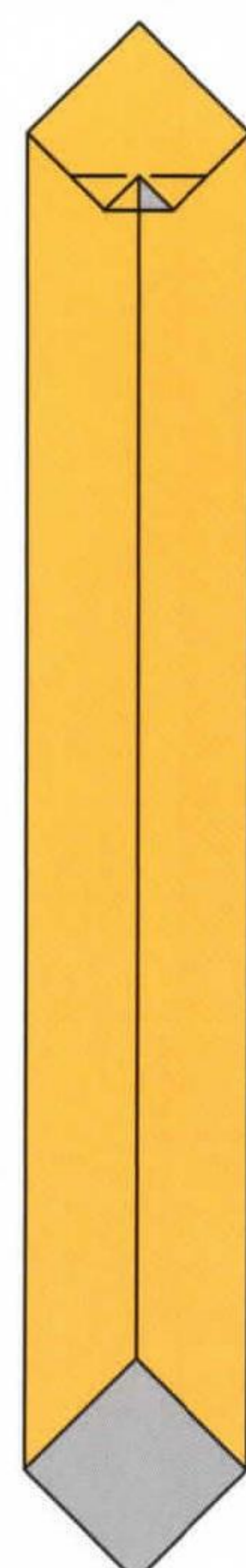

27. Valley fold

floor lamp

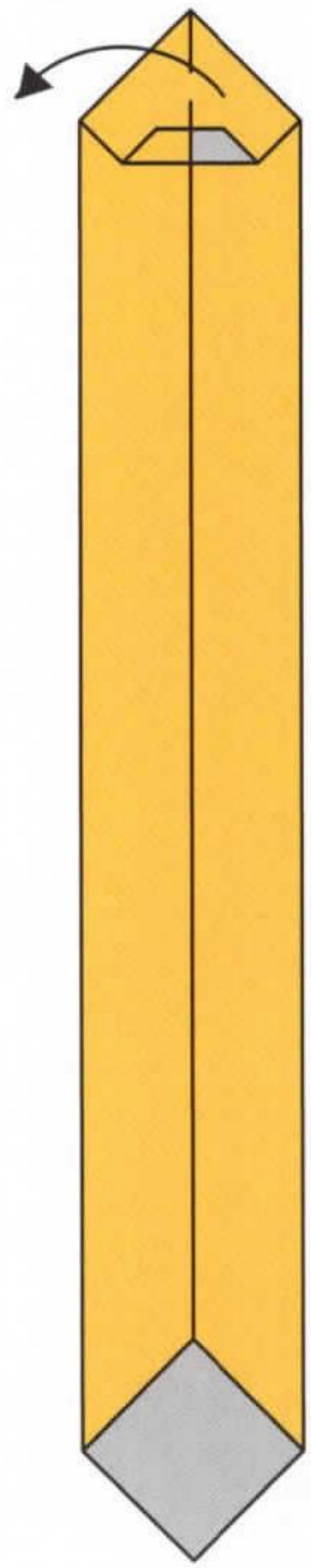

28. Valley fold

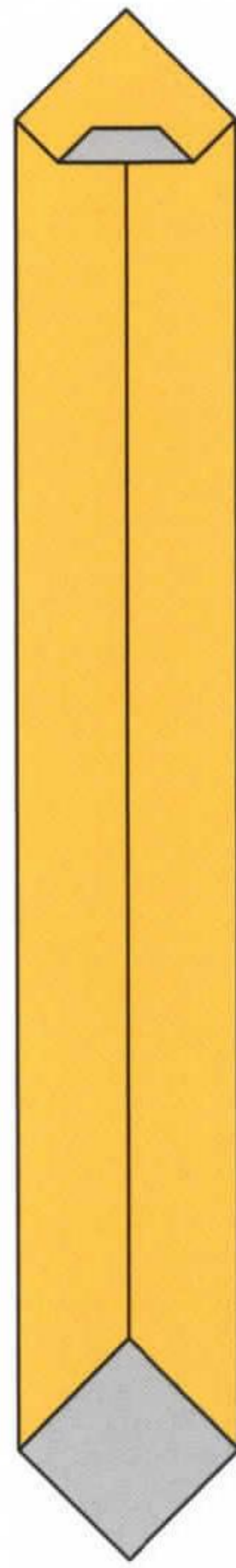

29. Turn over

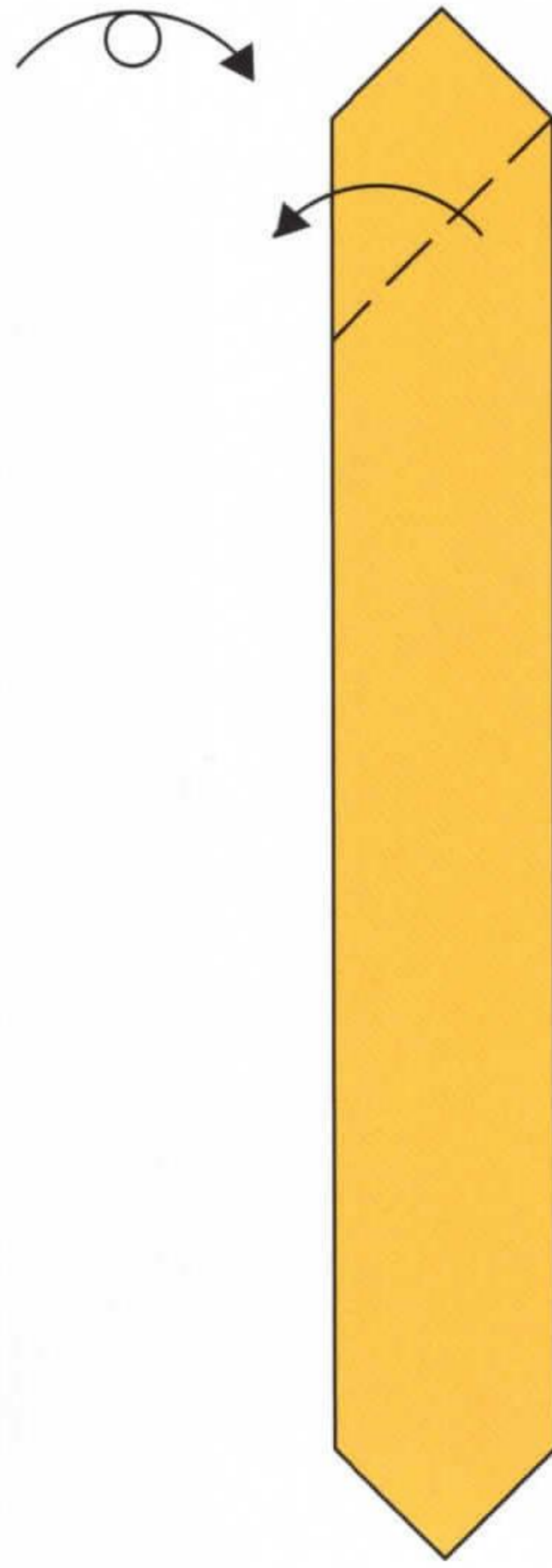

30. Valley fold

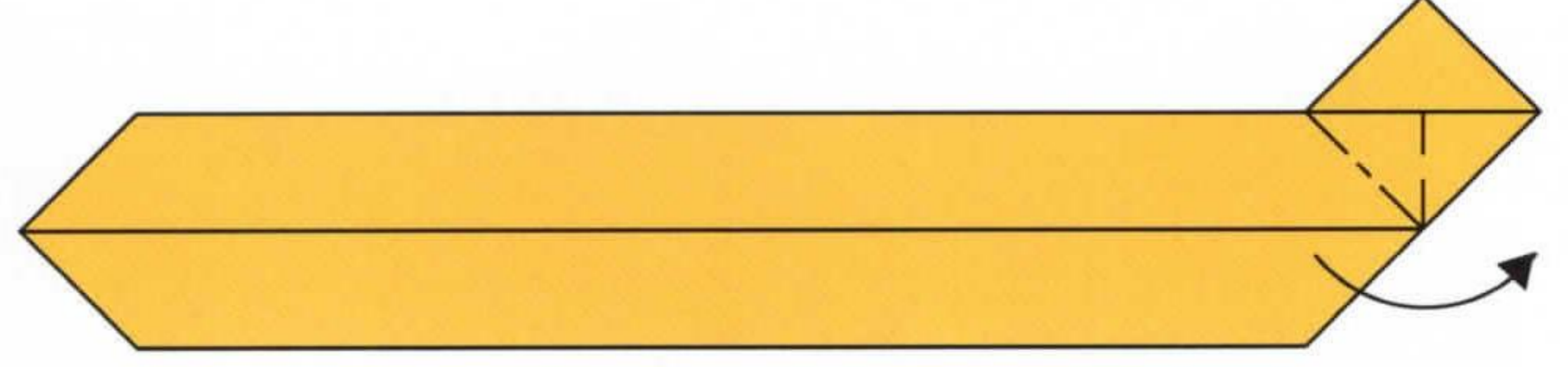

31. Crimp fold

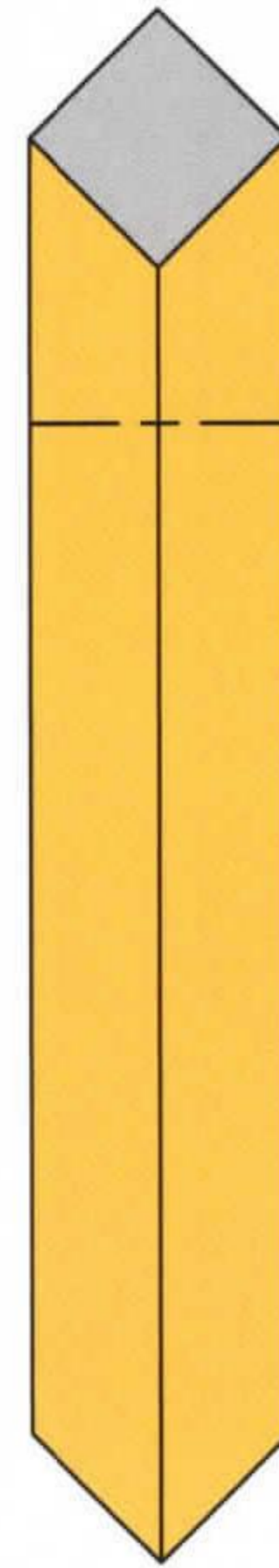

32. Mountain fold



33. Inside reverse folds

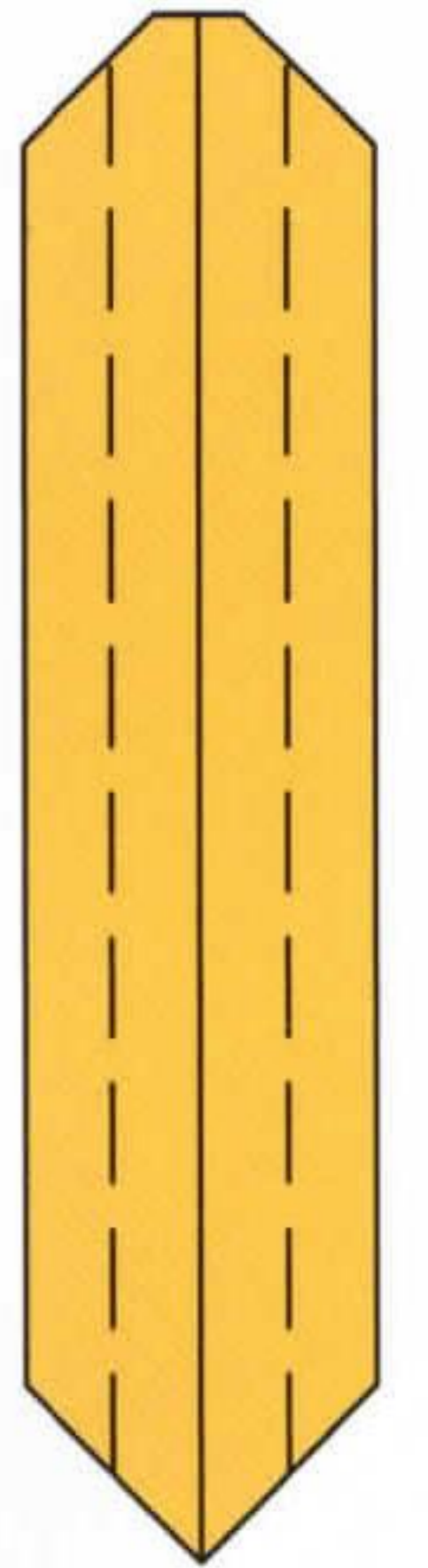

34. Valley folds

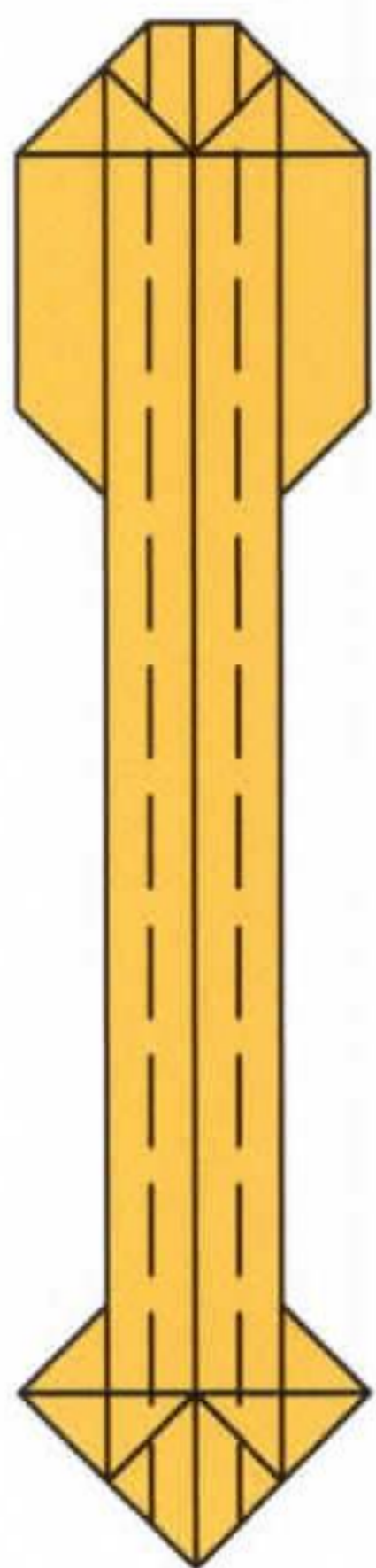

35. Valley folds

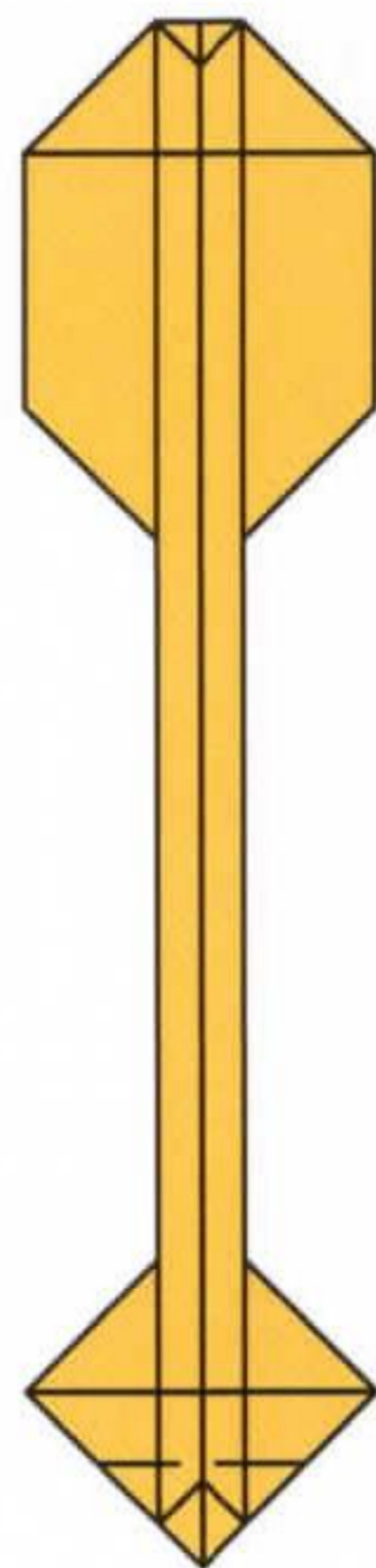

36. Valley fold

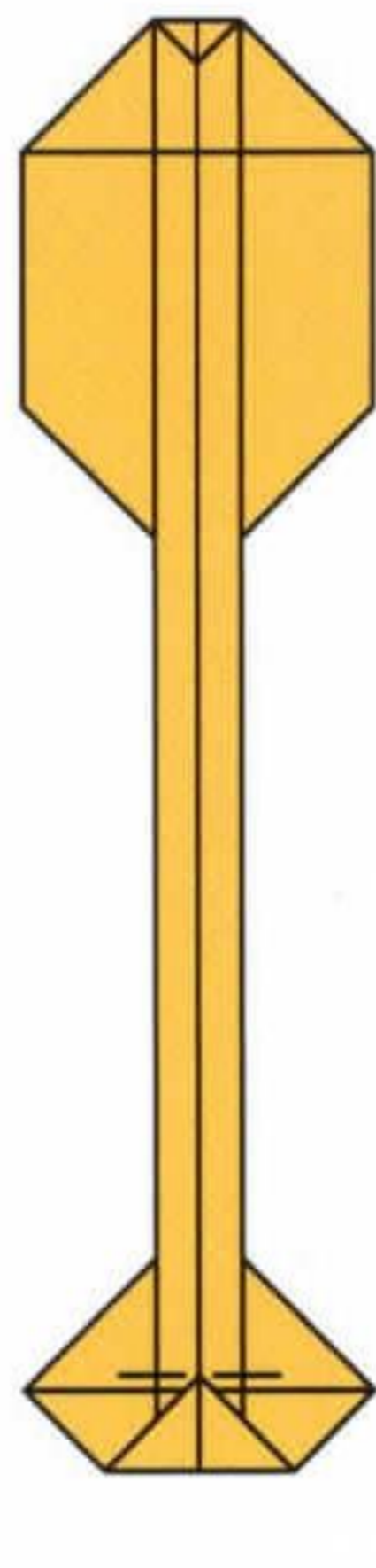

37. Valley fold

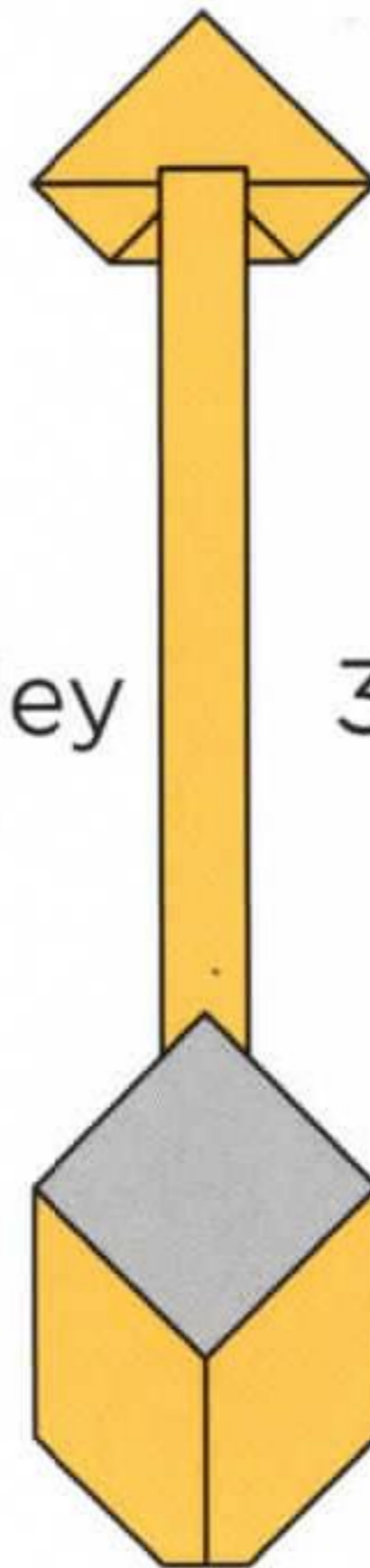

38. Valley fold



39. Open flaps



40. Pull and fold

floor lamp

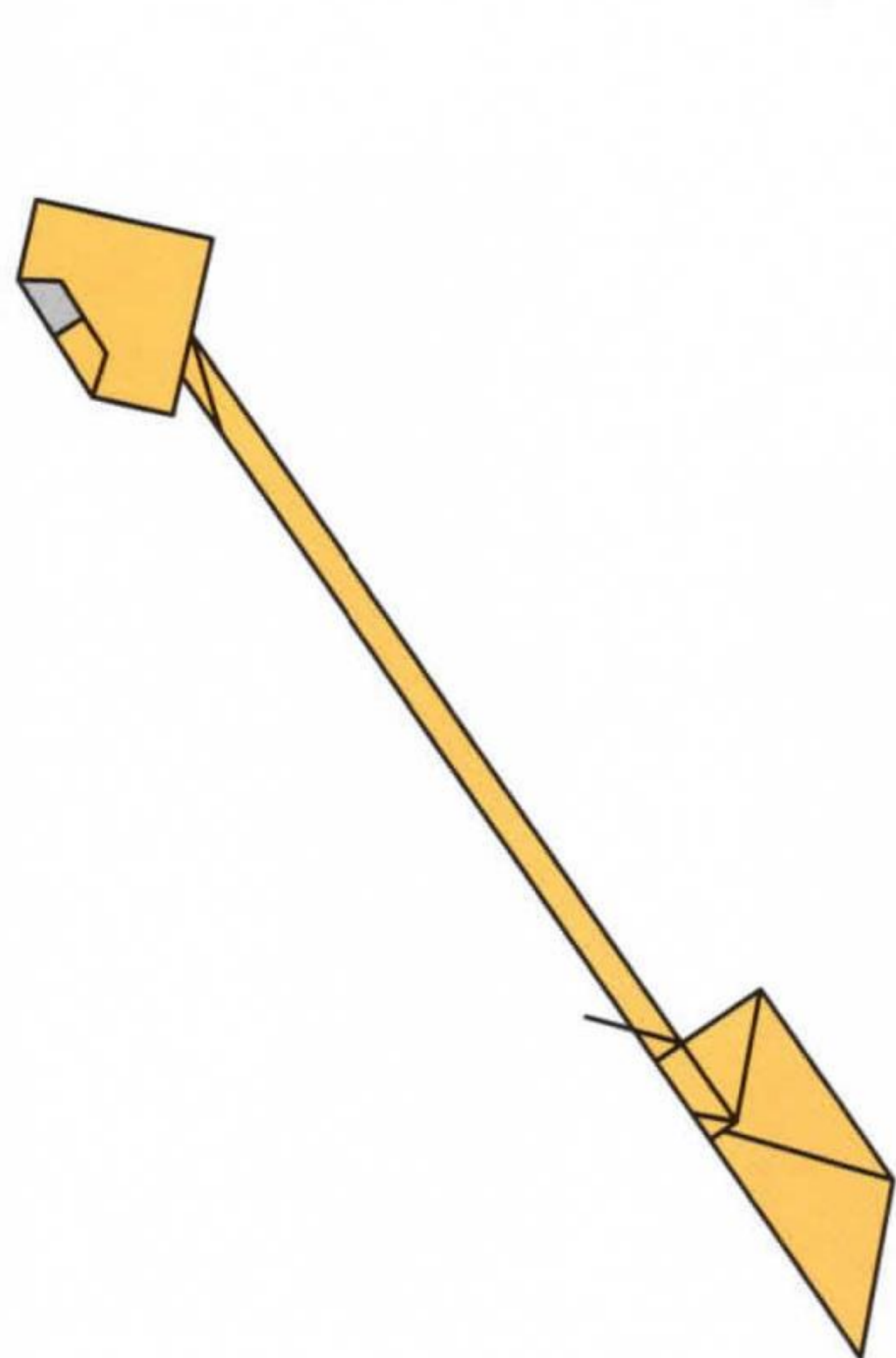

41. Outside reverse folds

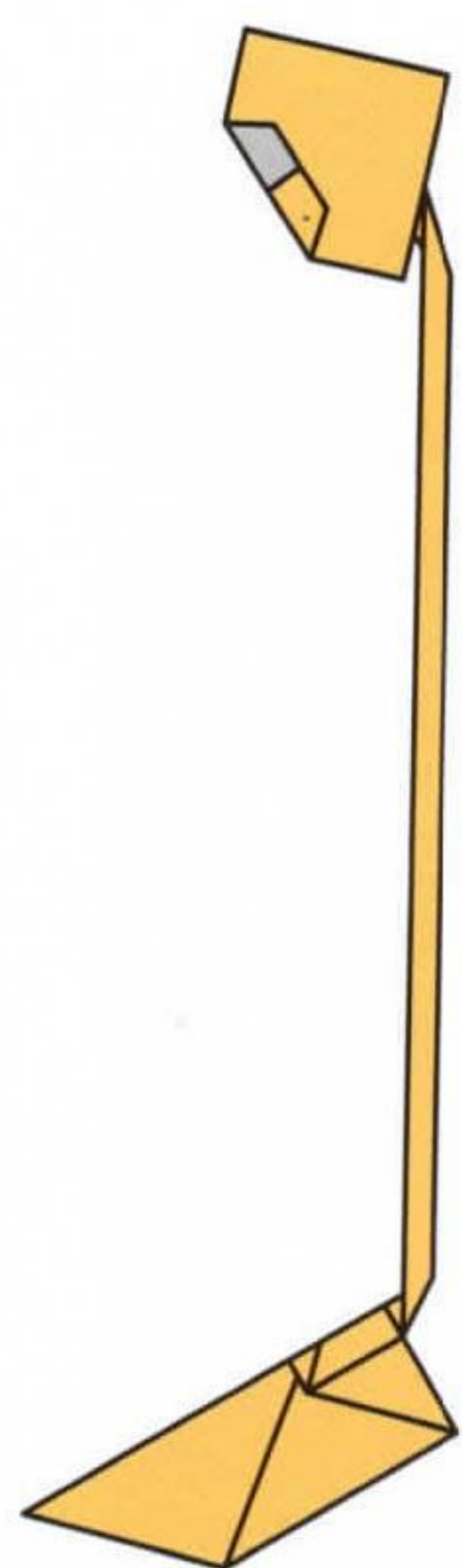

42. Crimp fold

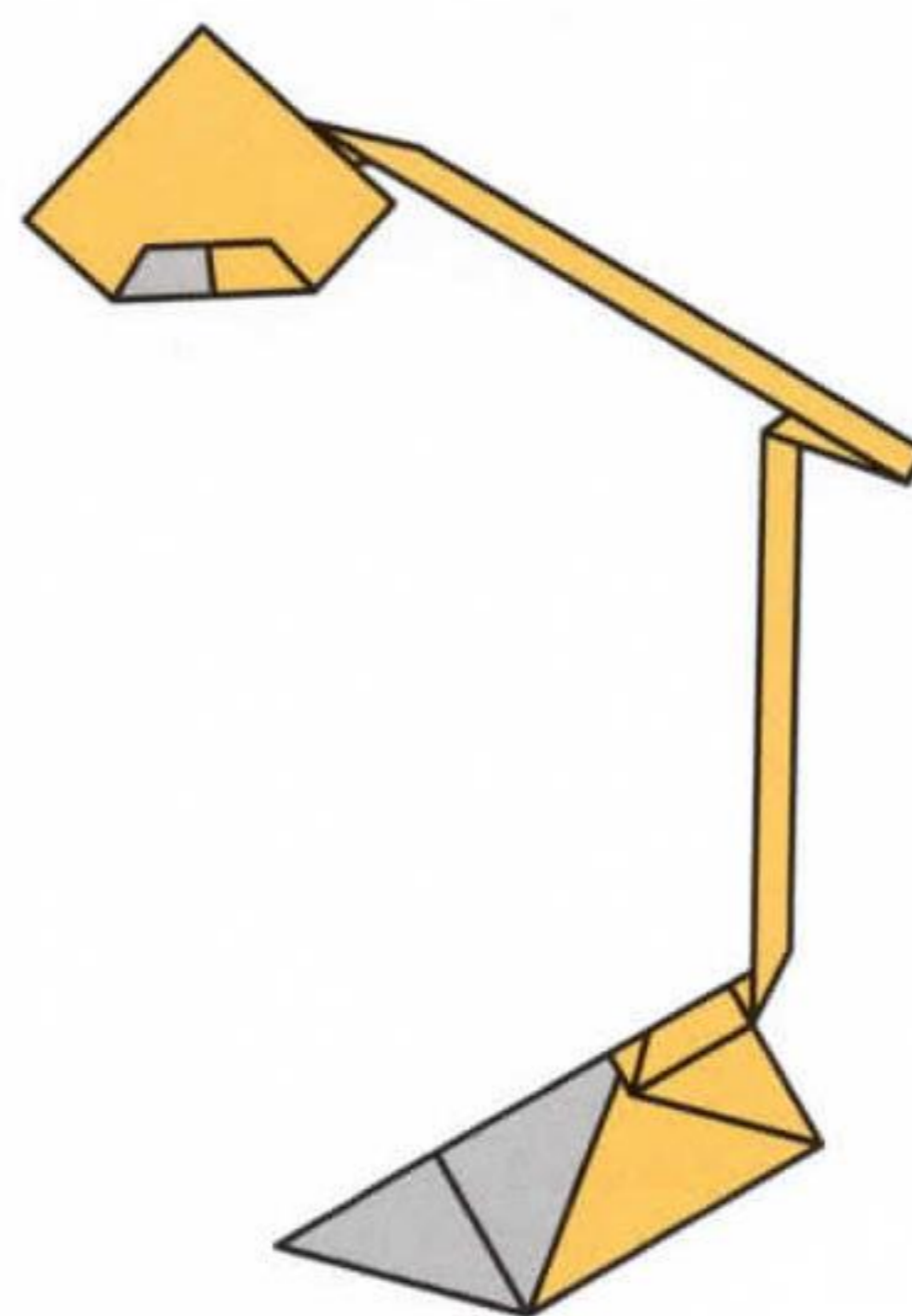

43. Outside reverse fold

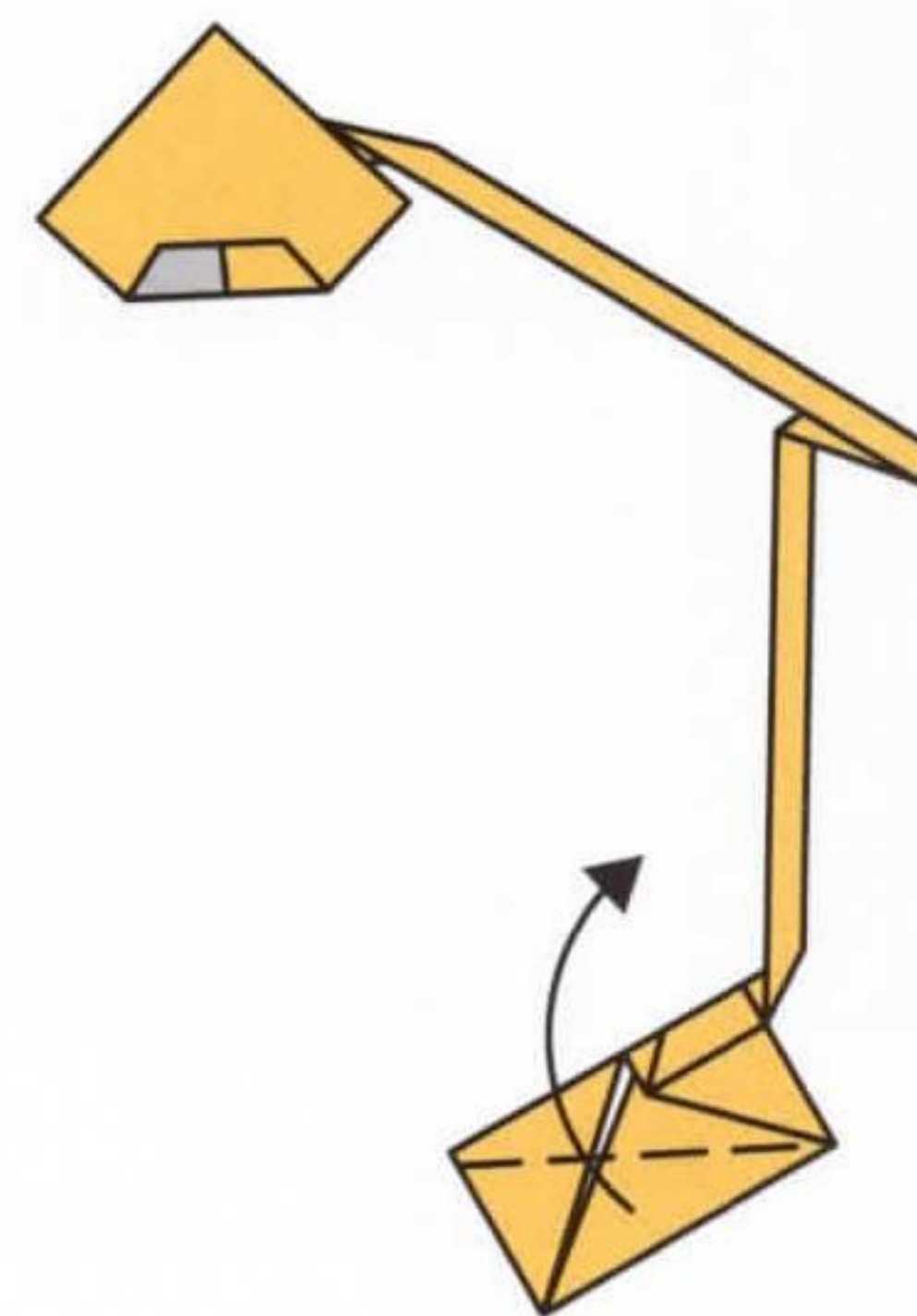

44. Valley fold

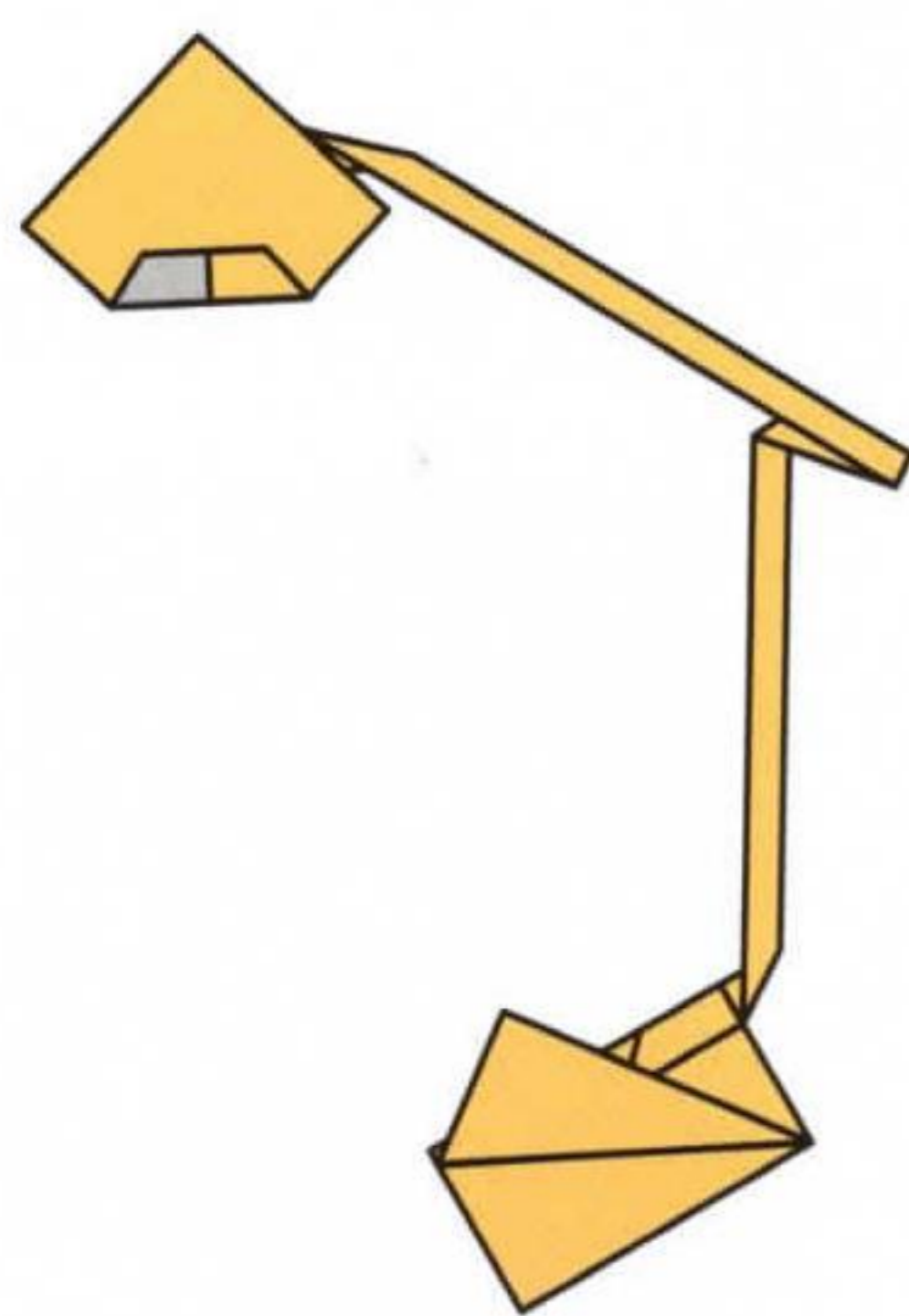

45. Turn over

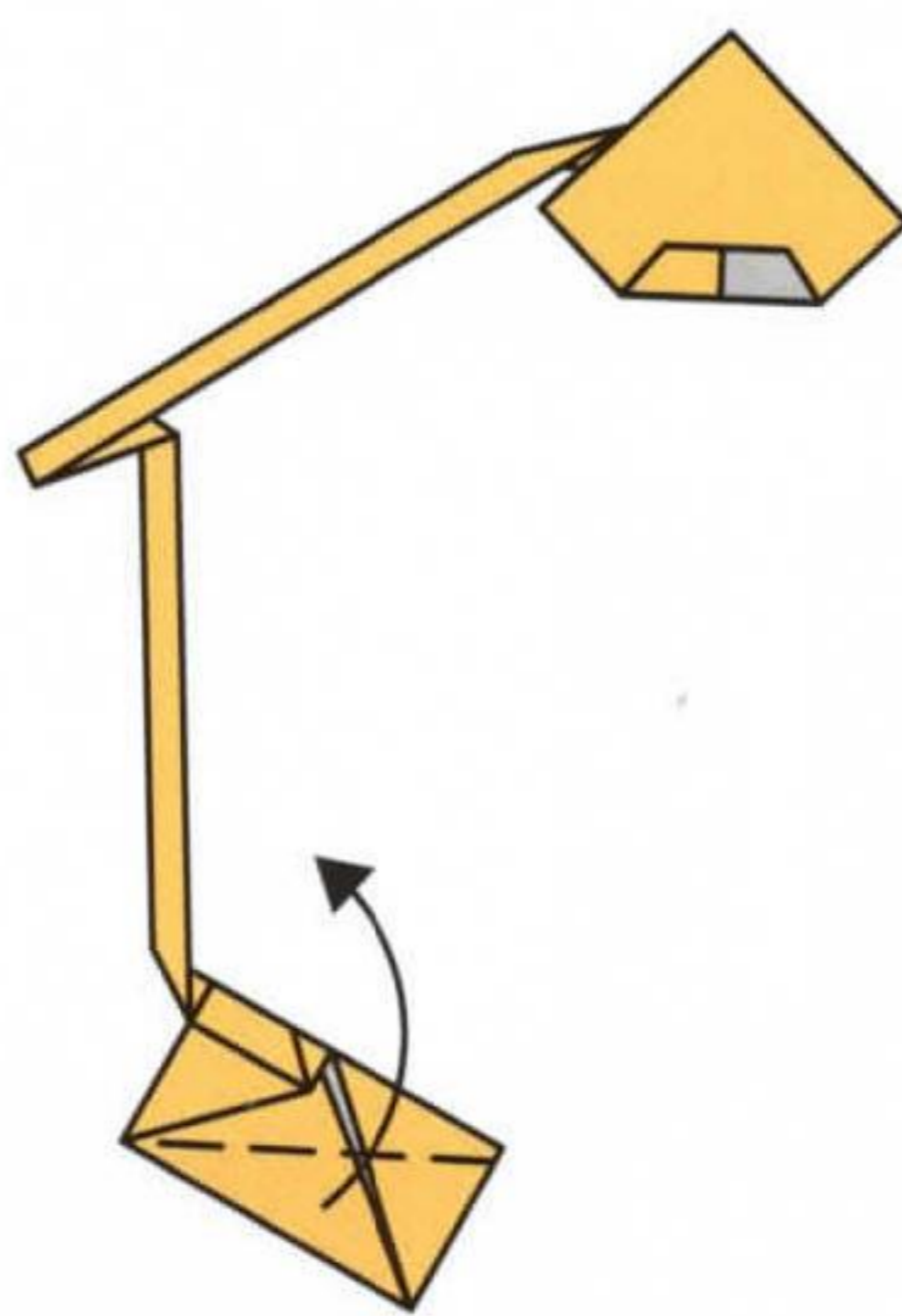

46. Valley fold

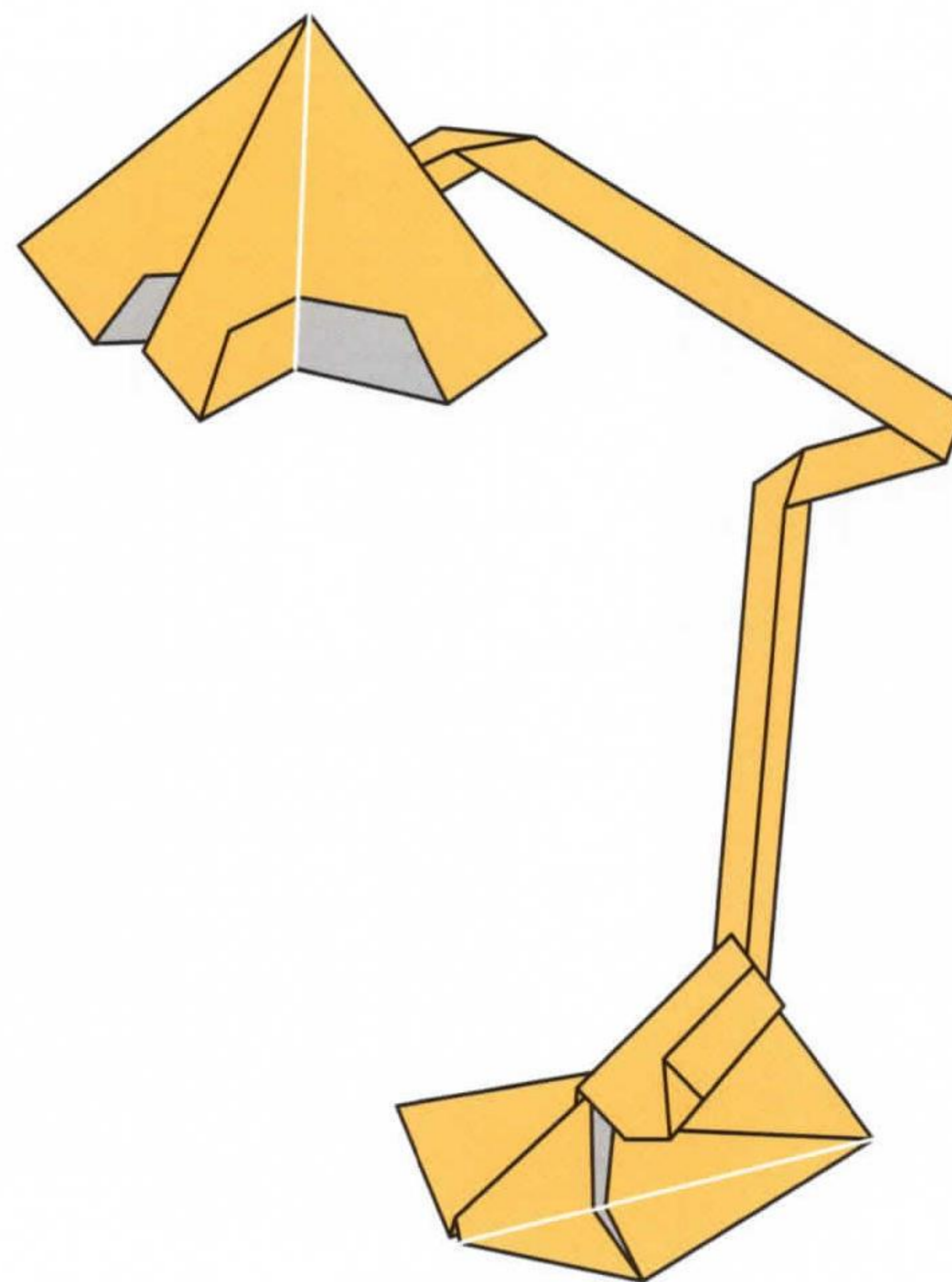

49. Completed FLOOR LAMP

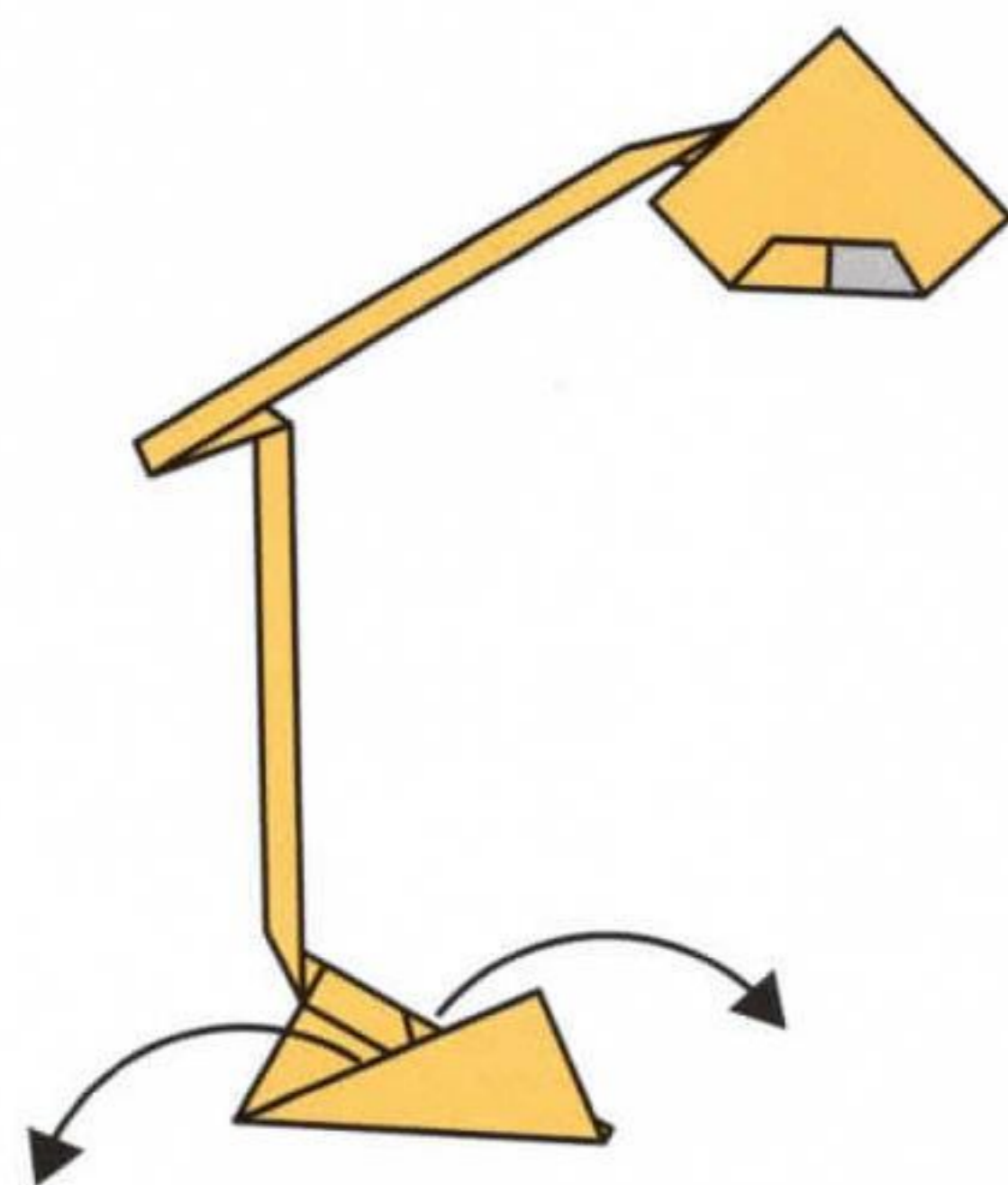

47. Valley fold both sides

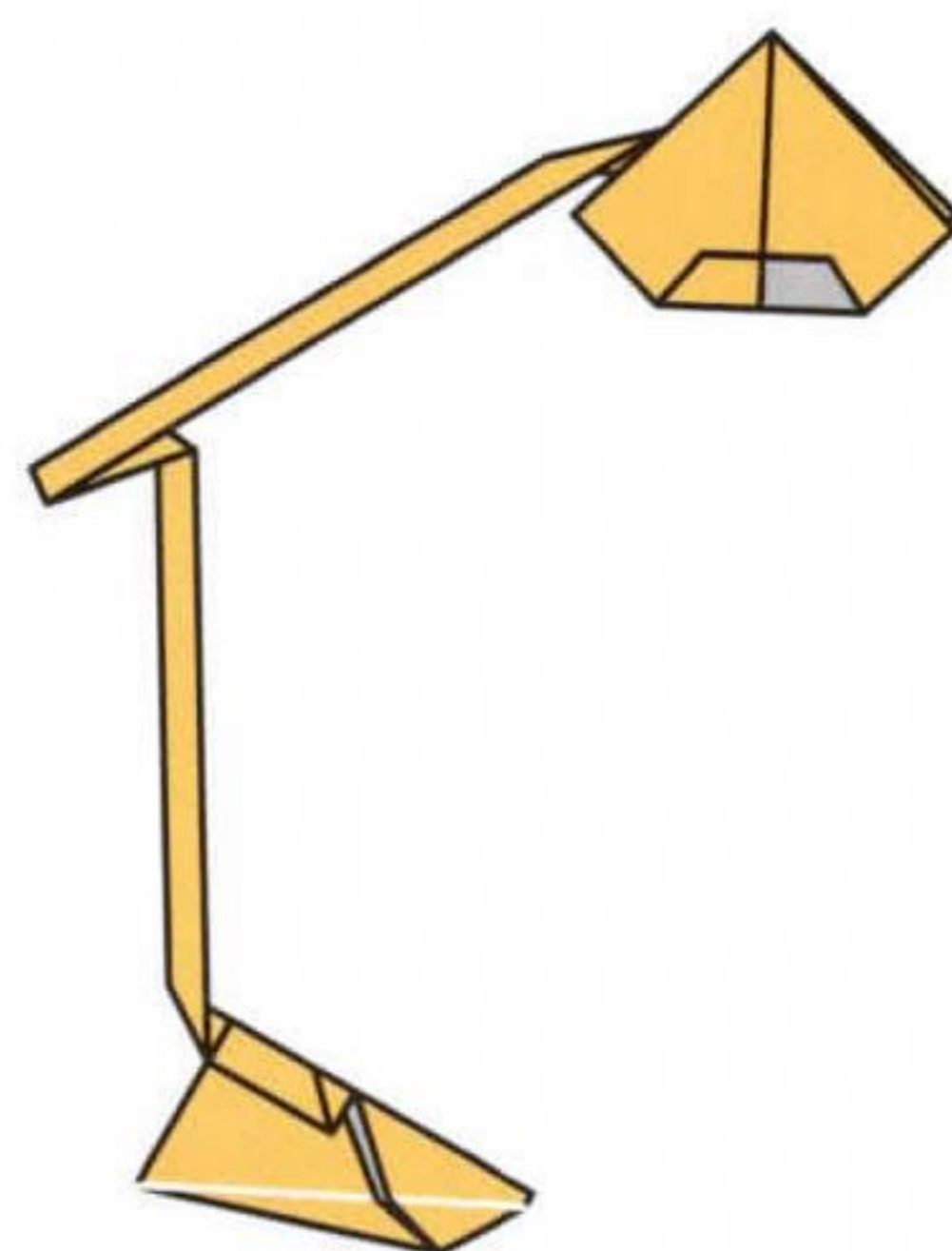

48. Open all flaps

► lounge chair

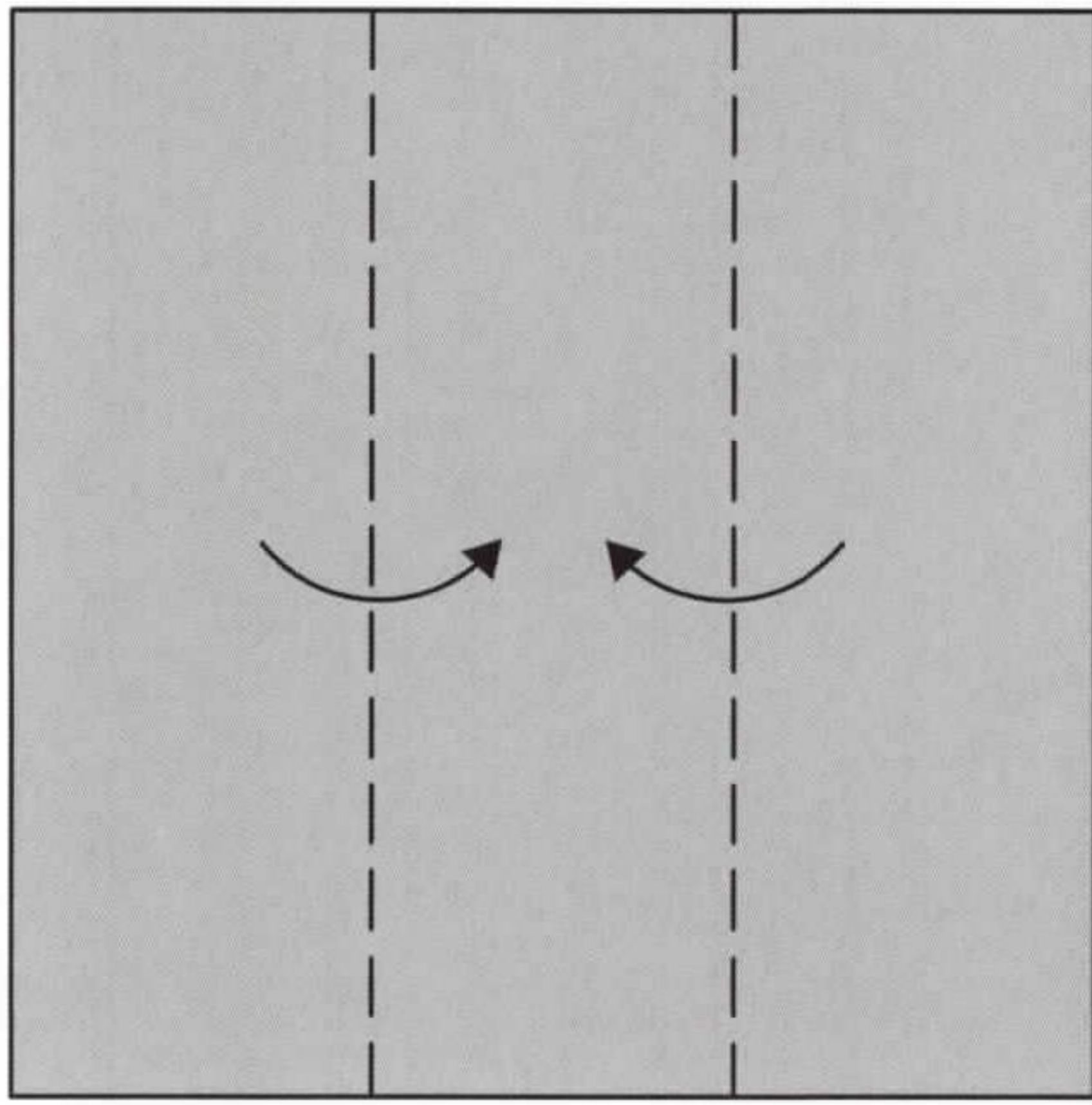

1. Valley folds

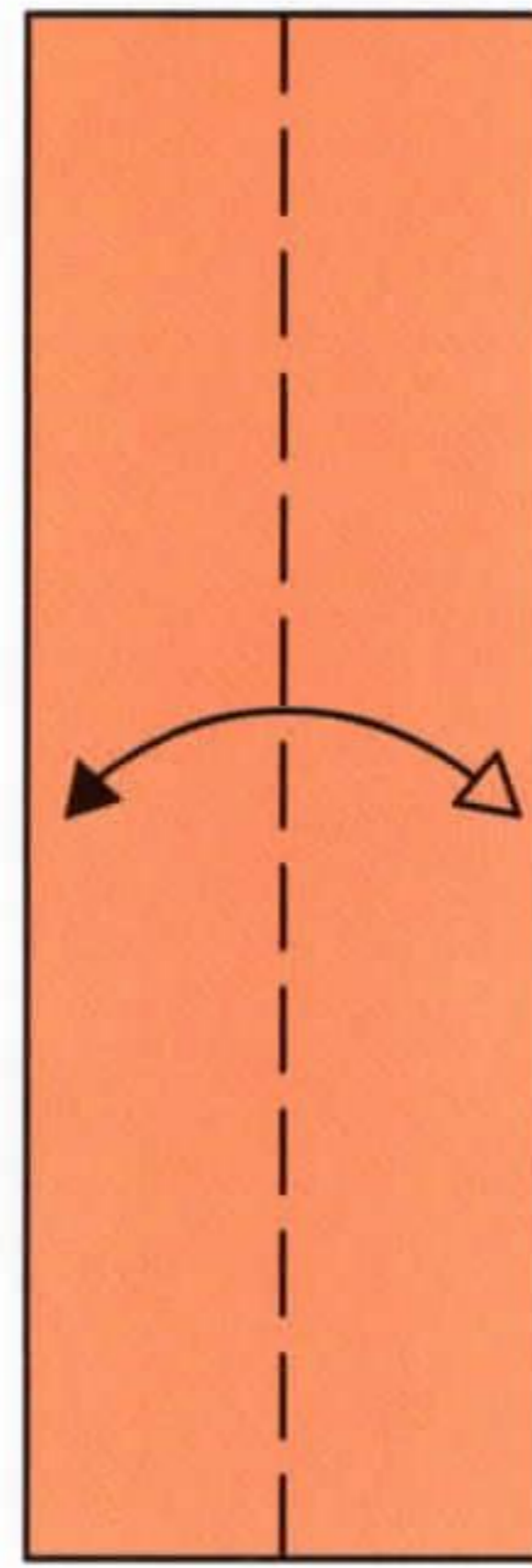

2. Valley fold and unfold

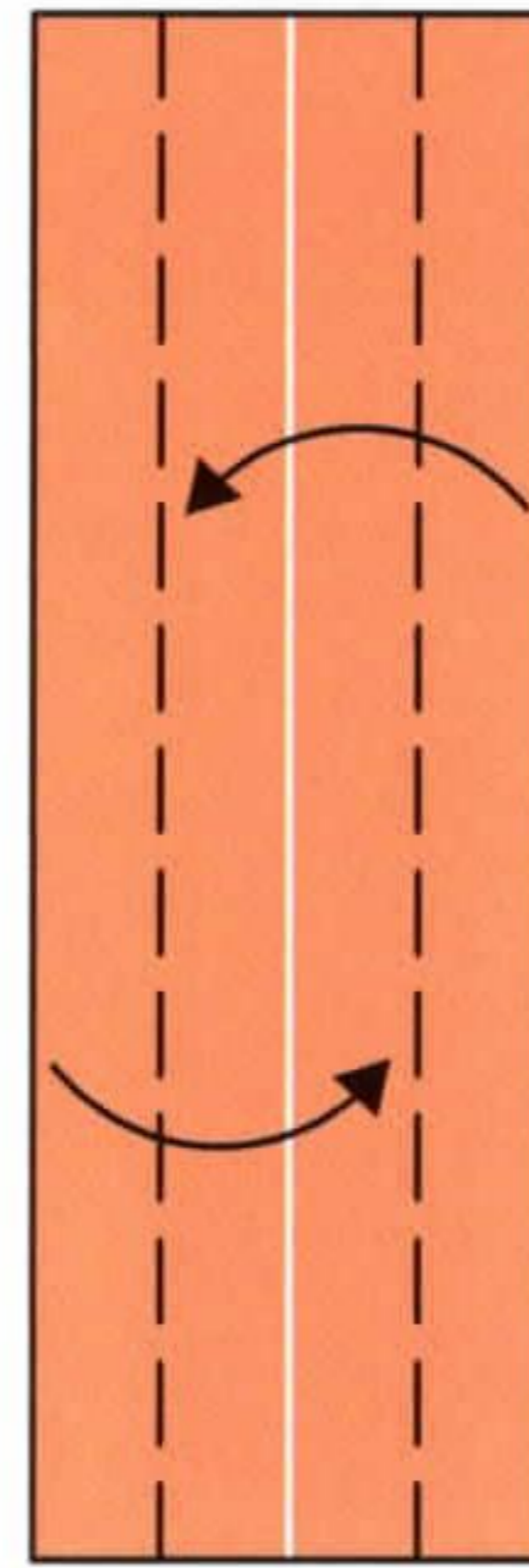

3. Valley folds

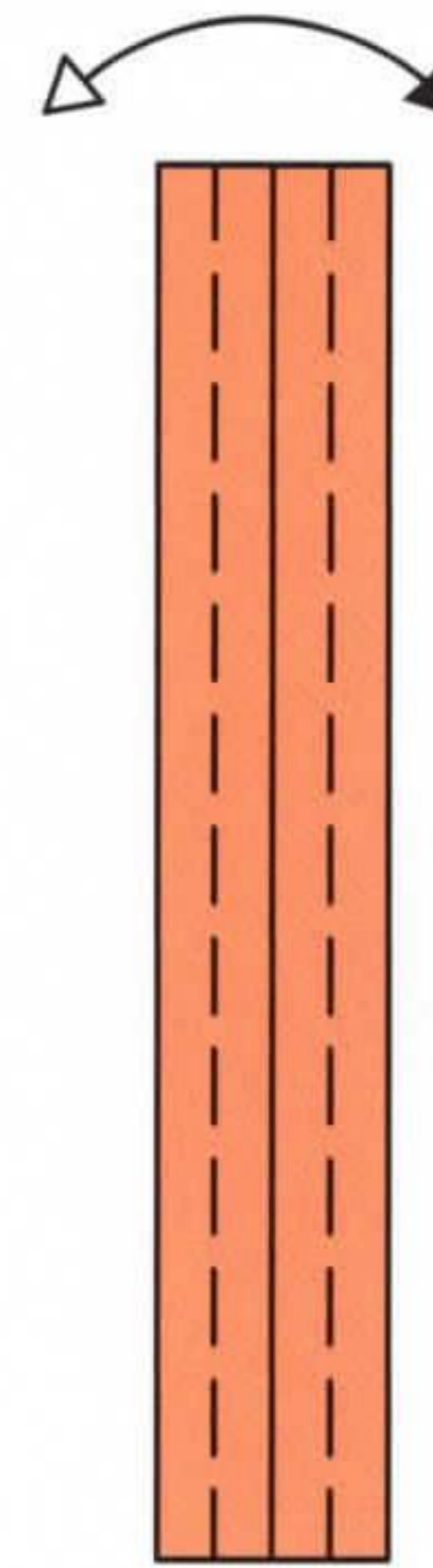

4. Valley fold and unfold

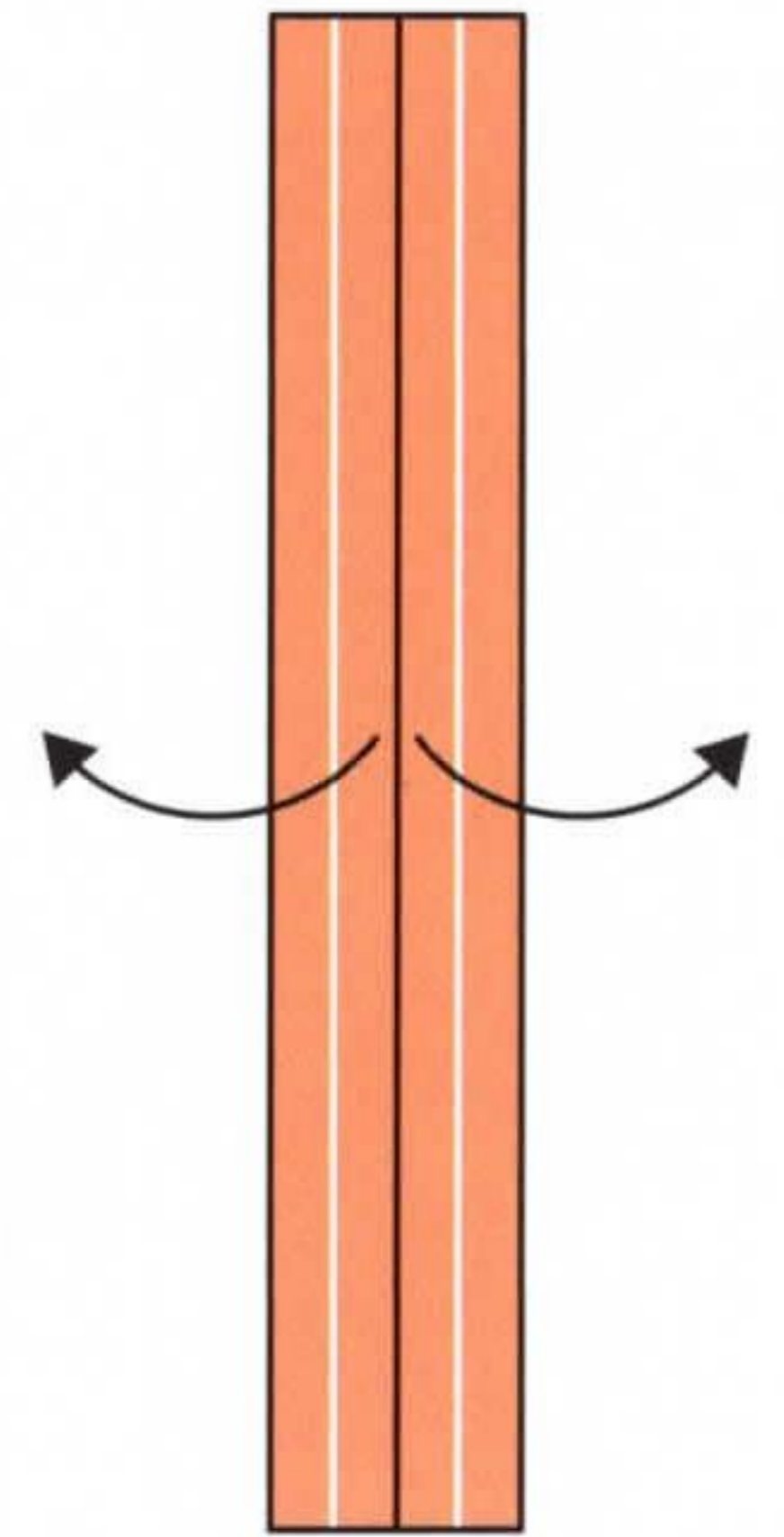

5. Valley folds

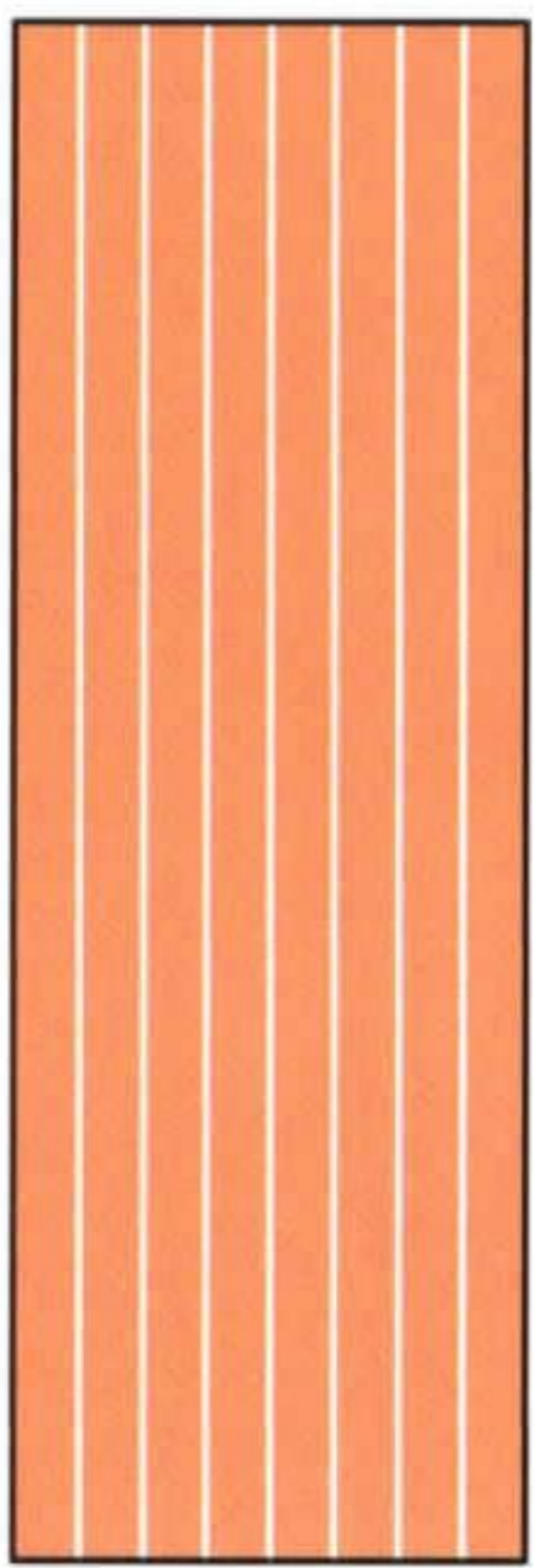

6. Scale-up

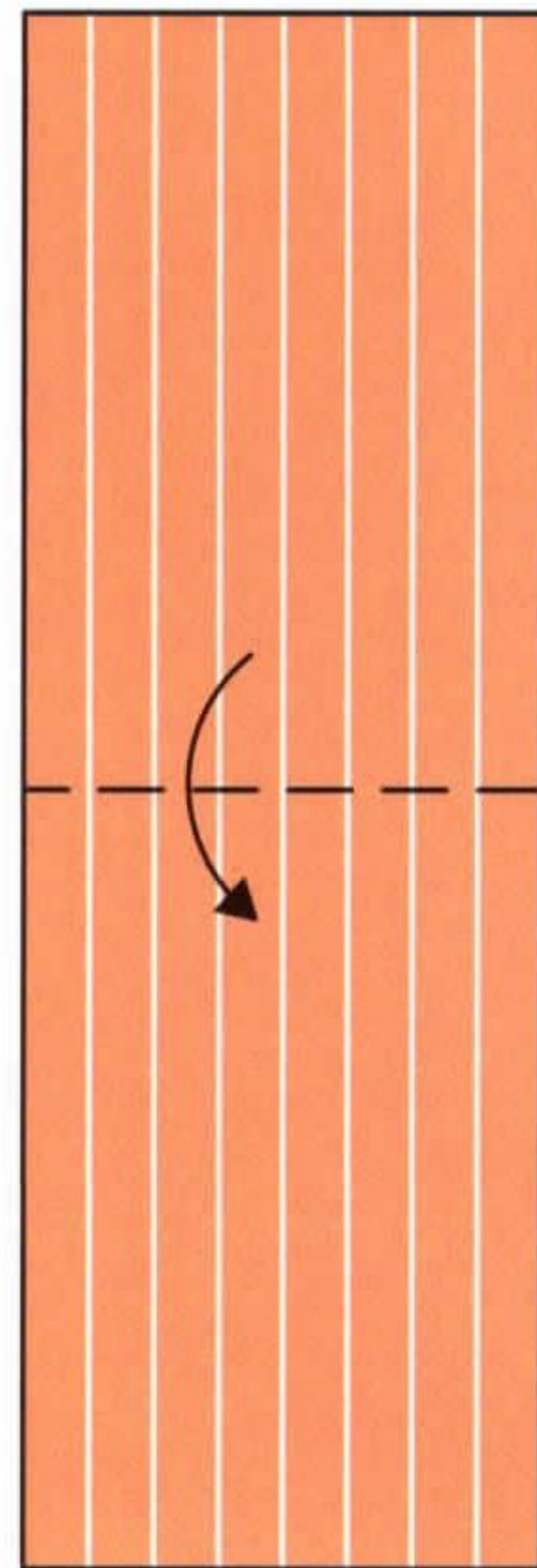

7. Valley fold

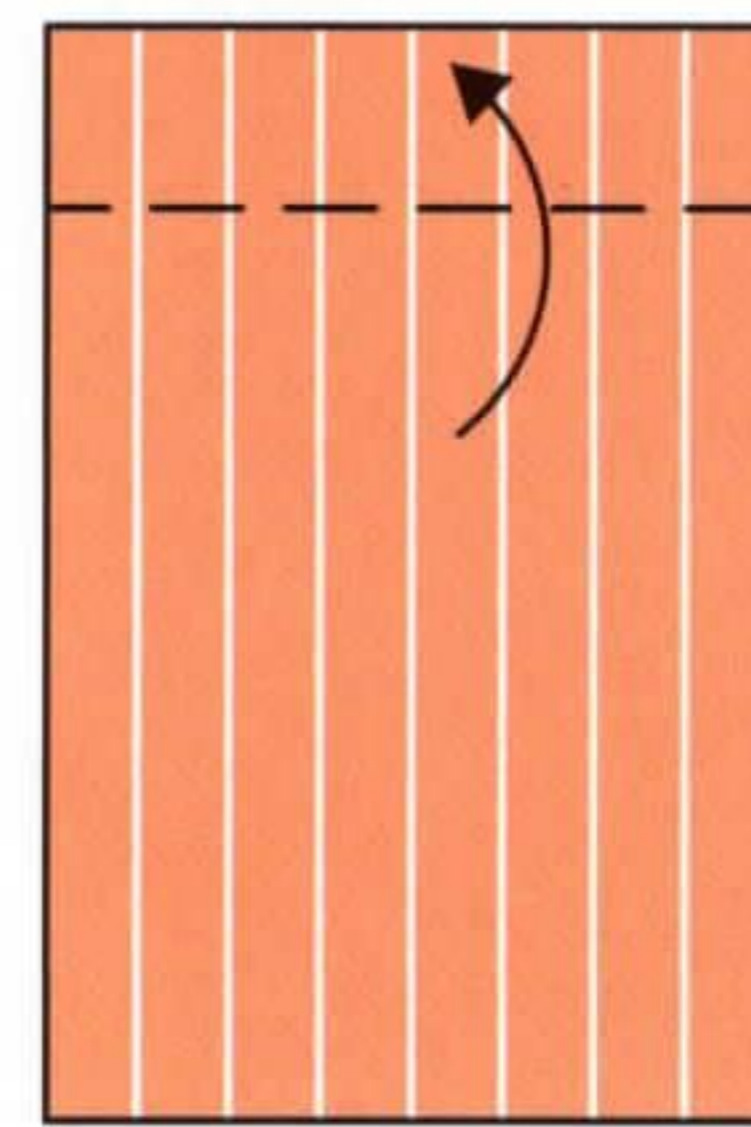

8. Valley fold

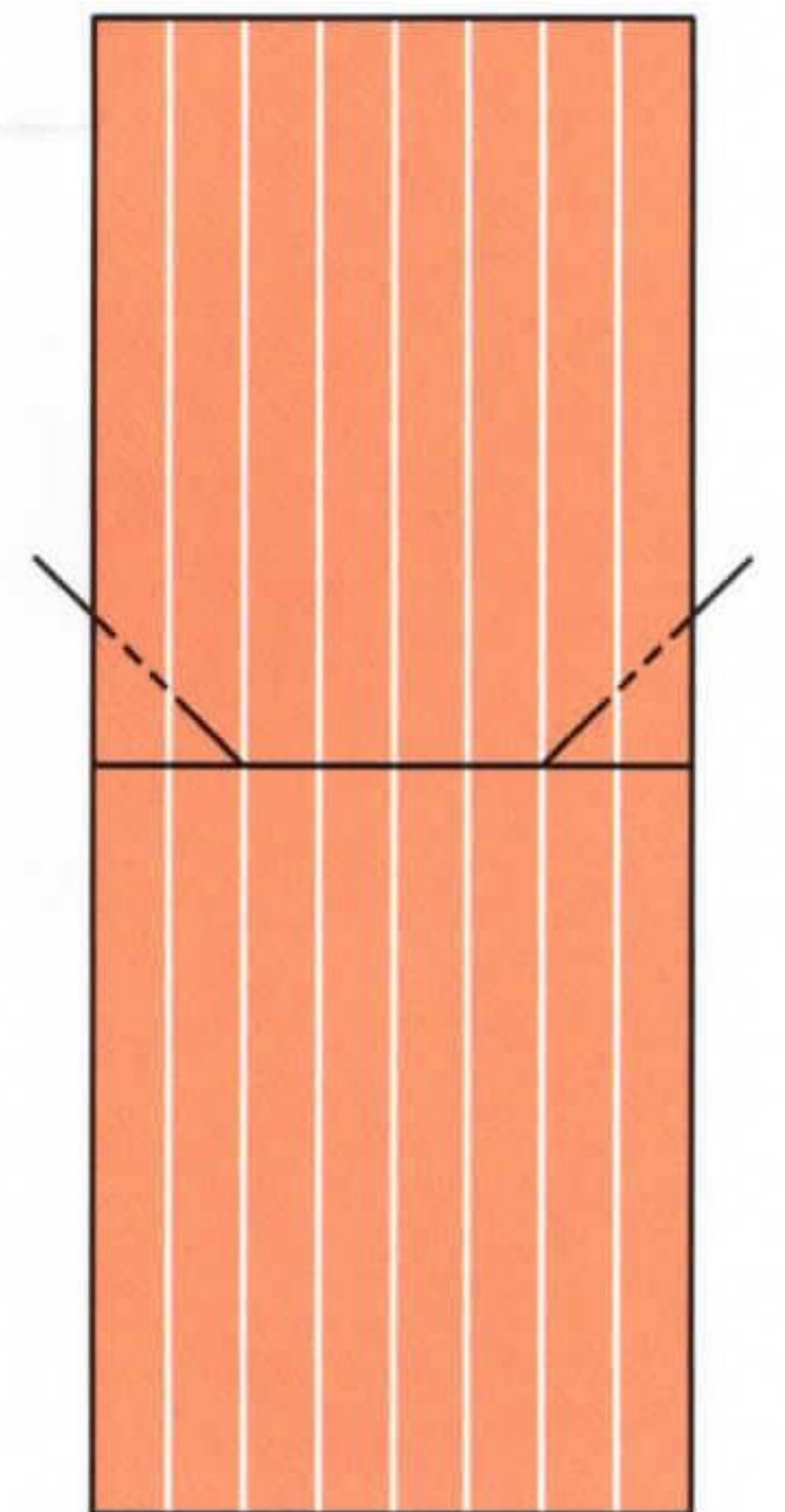

9. Inside reverse folds

lounge chair

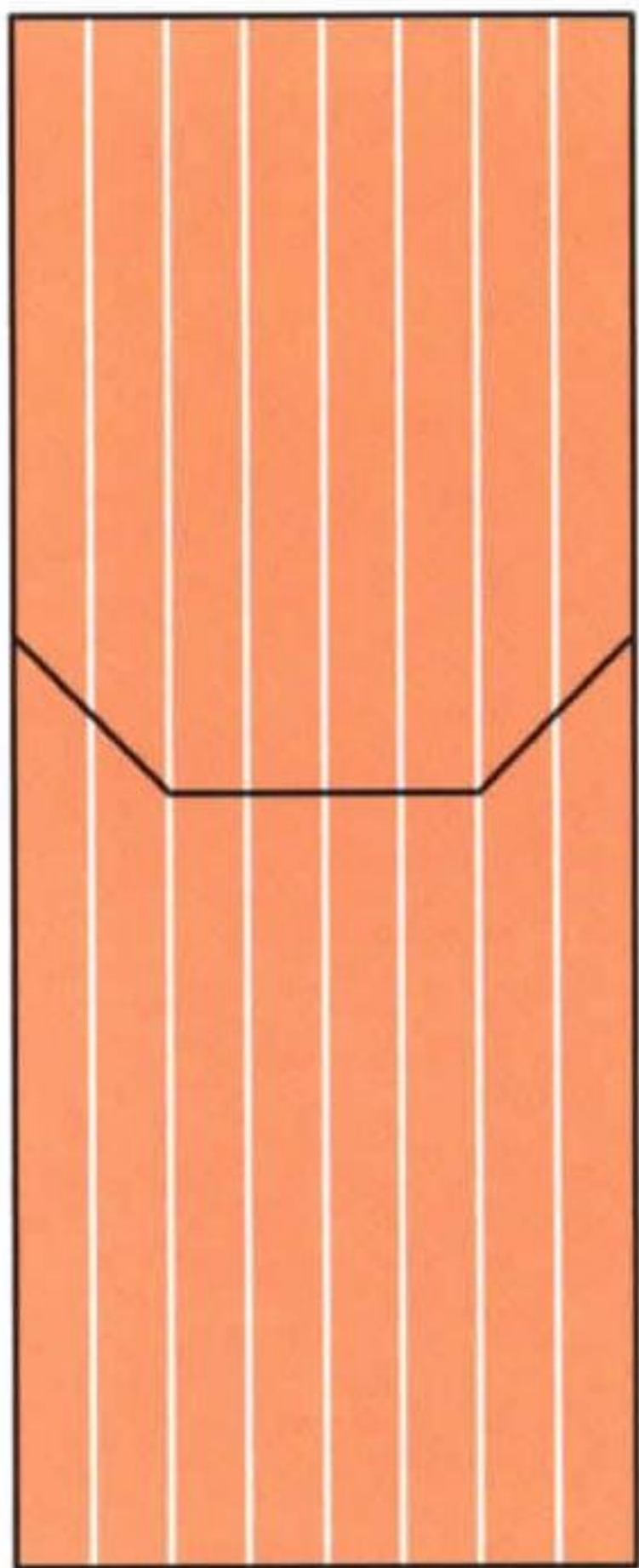

10. Turn over

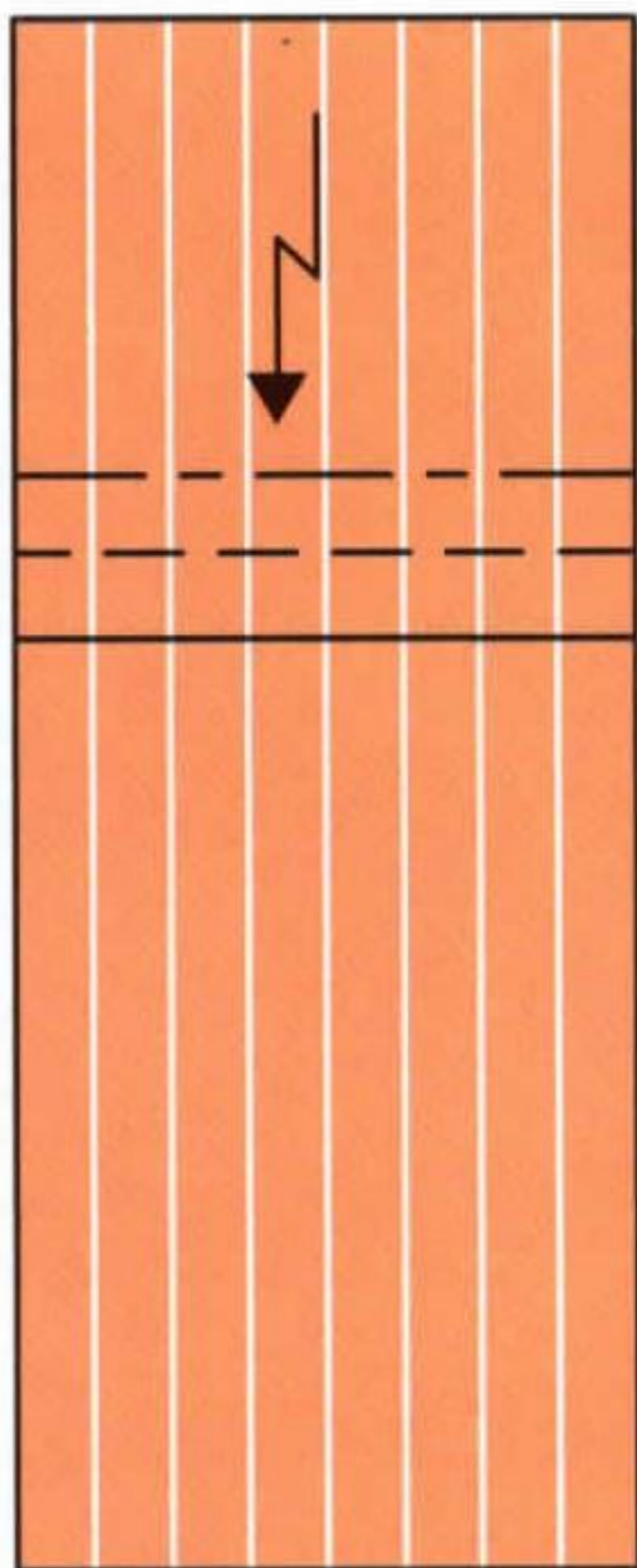
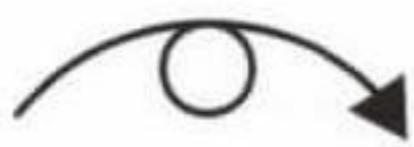

11. Pleat fold

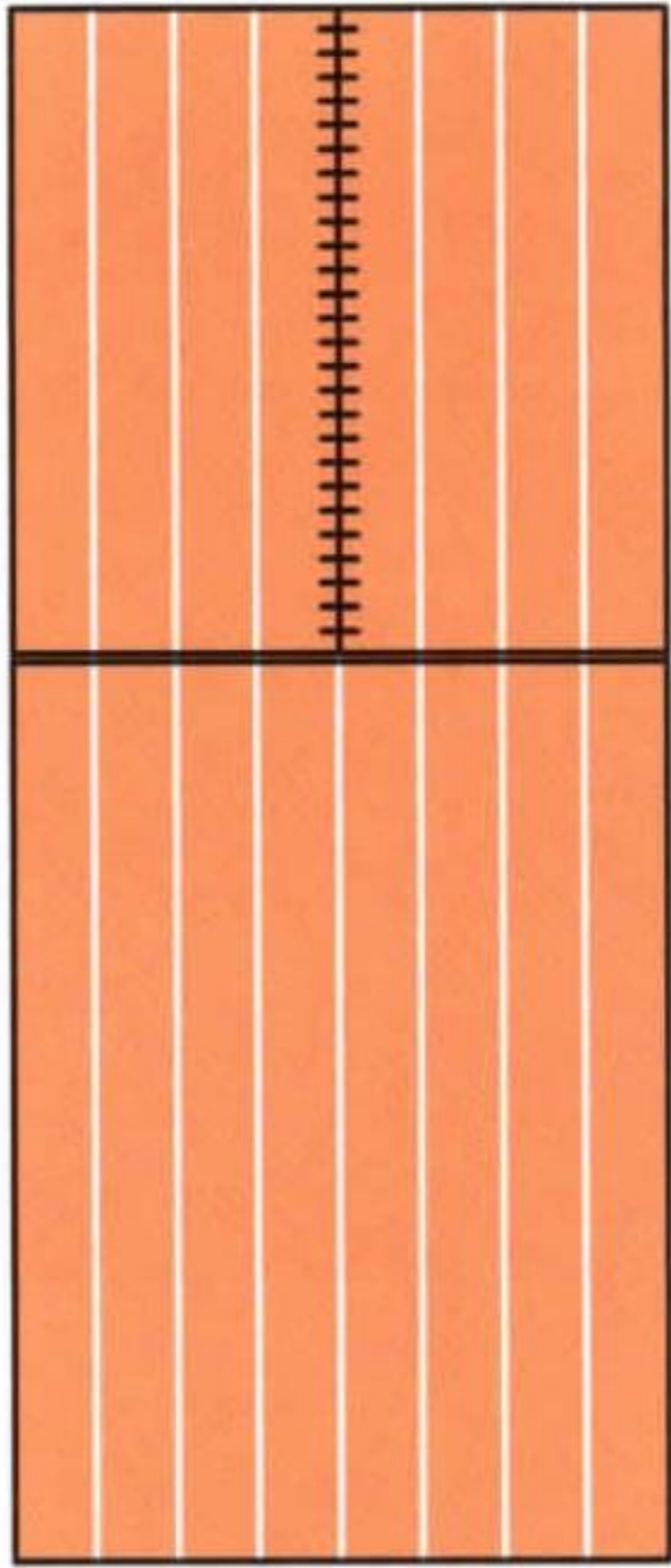

12. Cut as shown

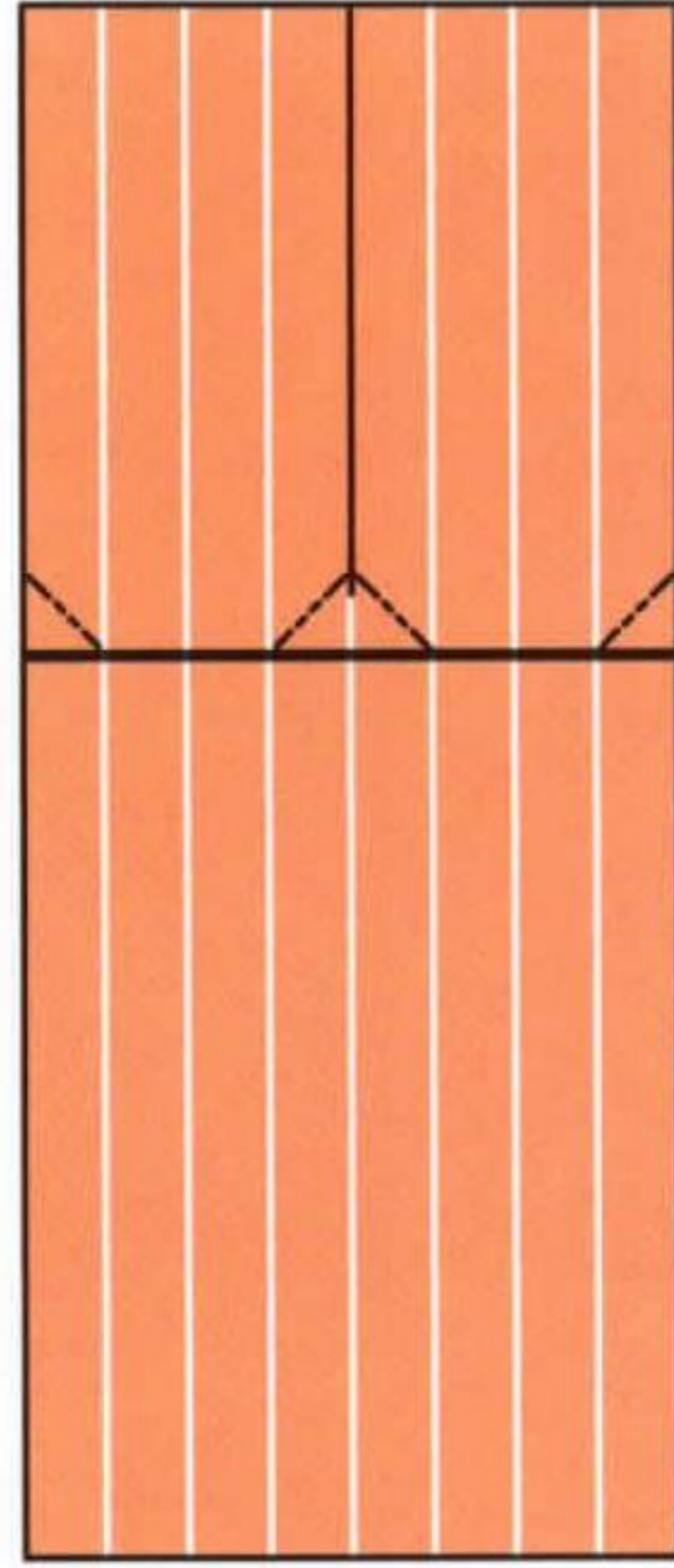

13. Inside reverse folds

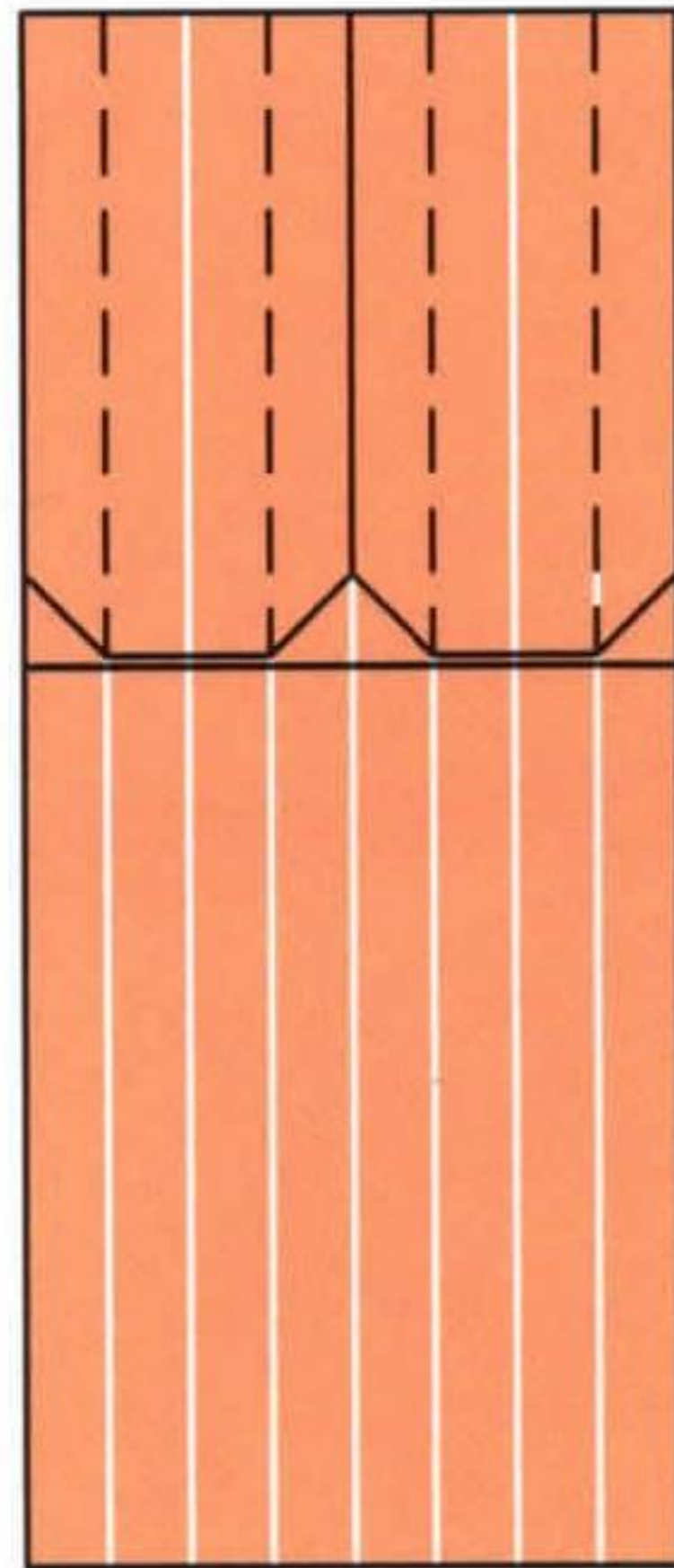

14. Valley folds

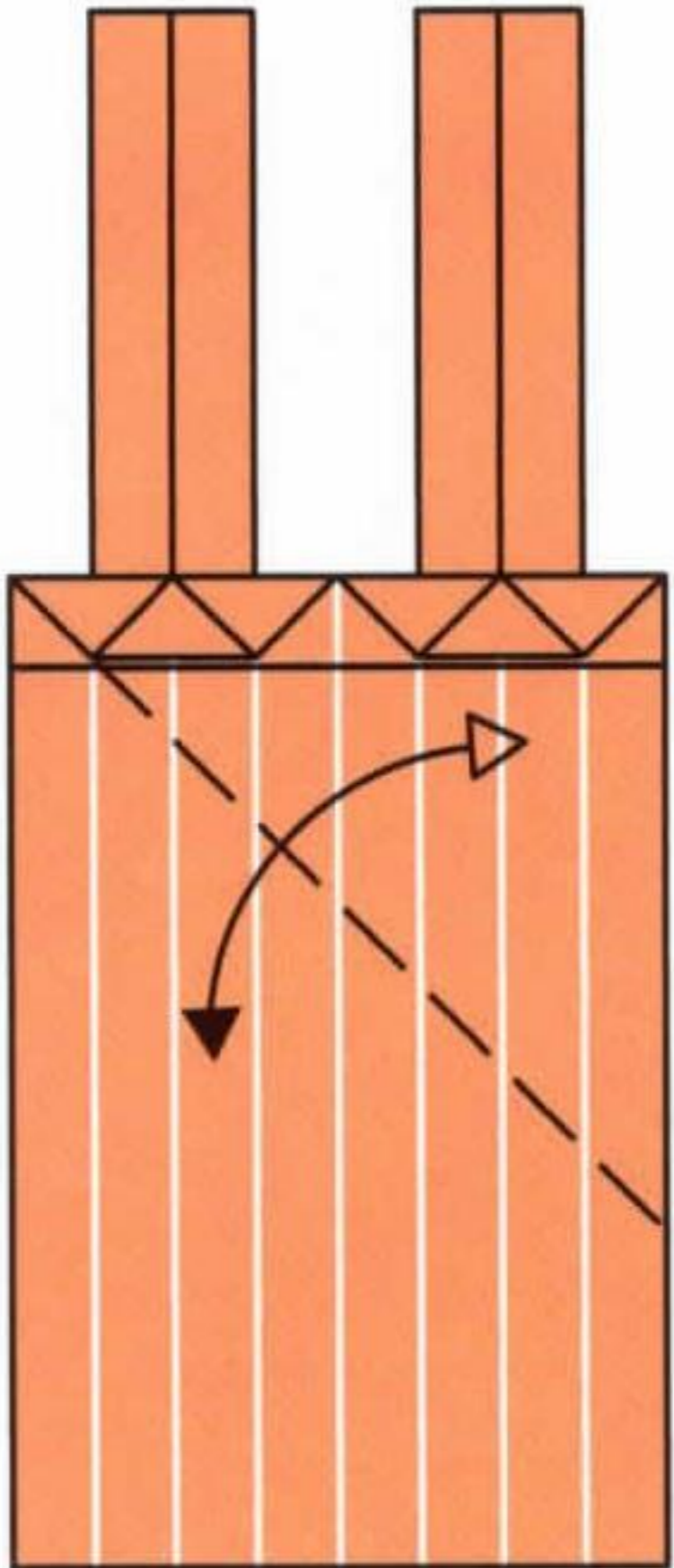

15. Valley fold and unfold

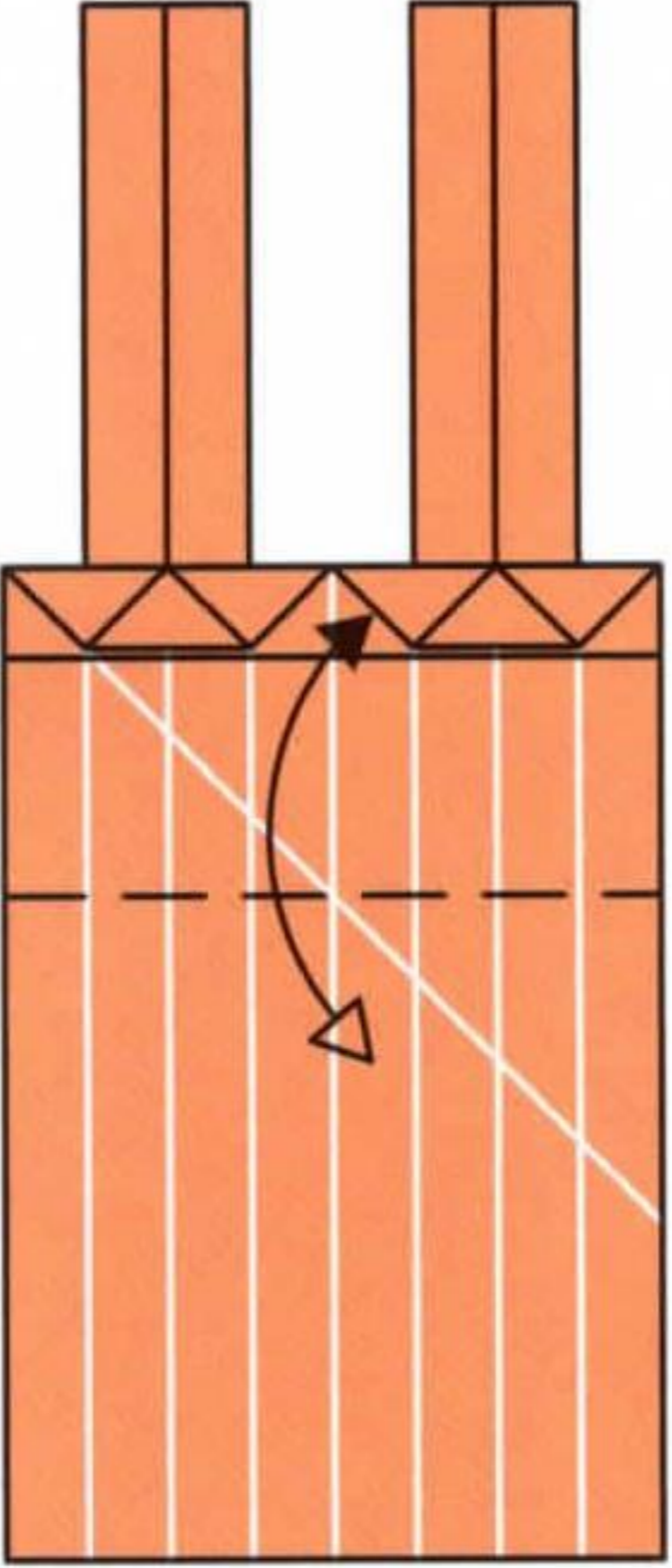

16. Repeat

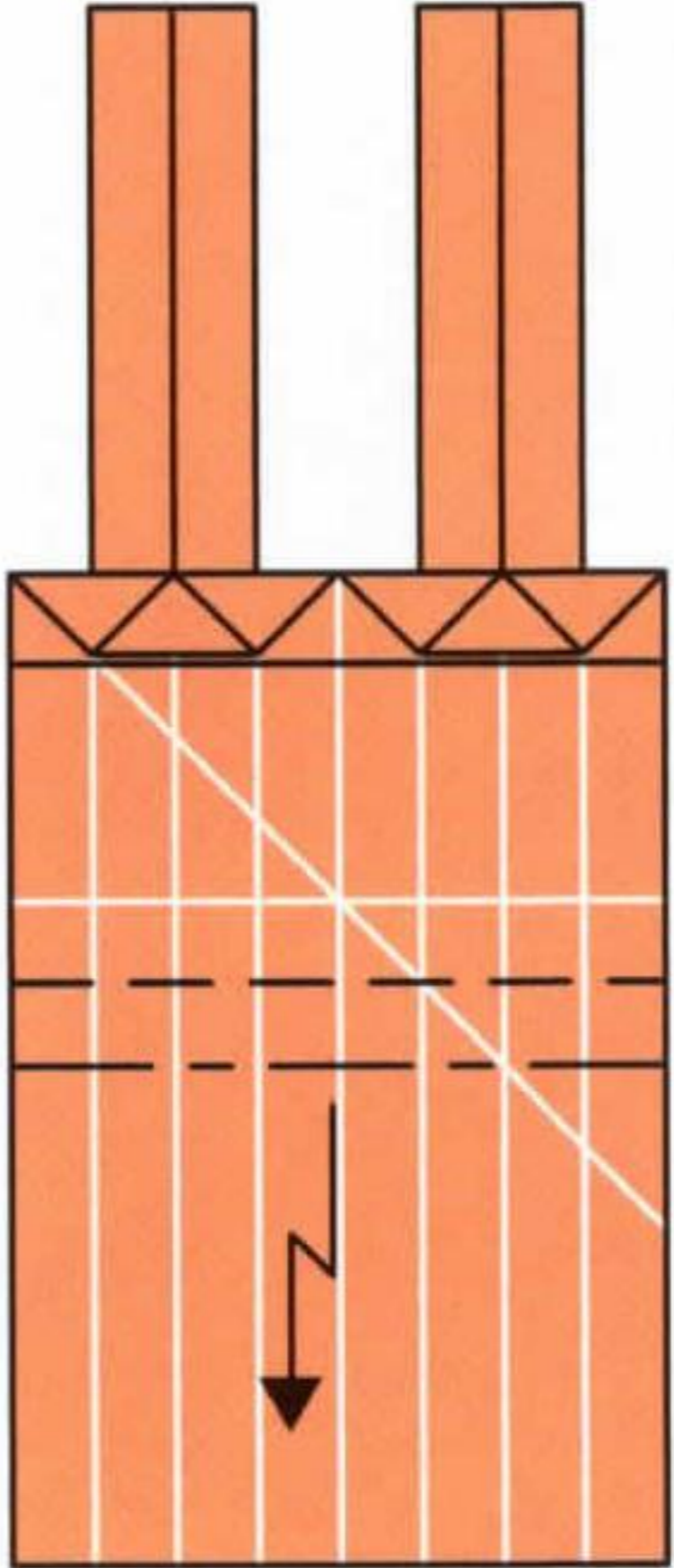

17. Pleat fold

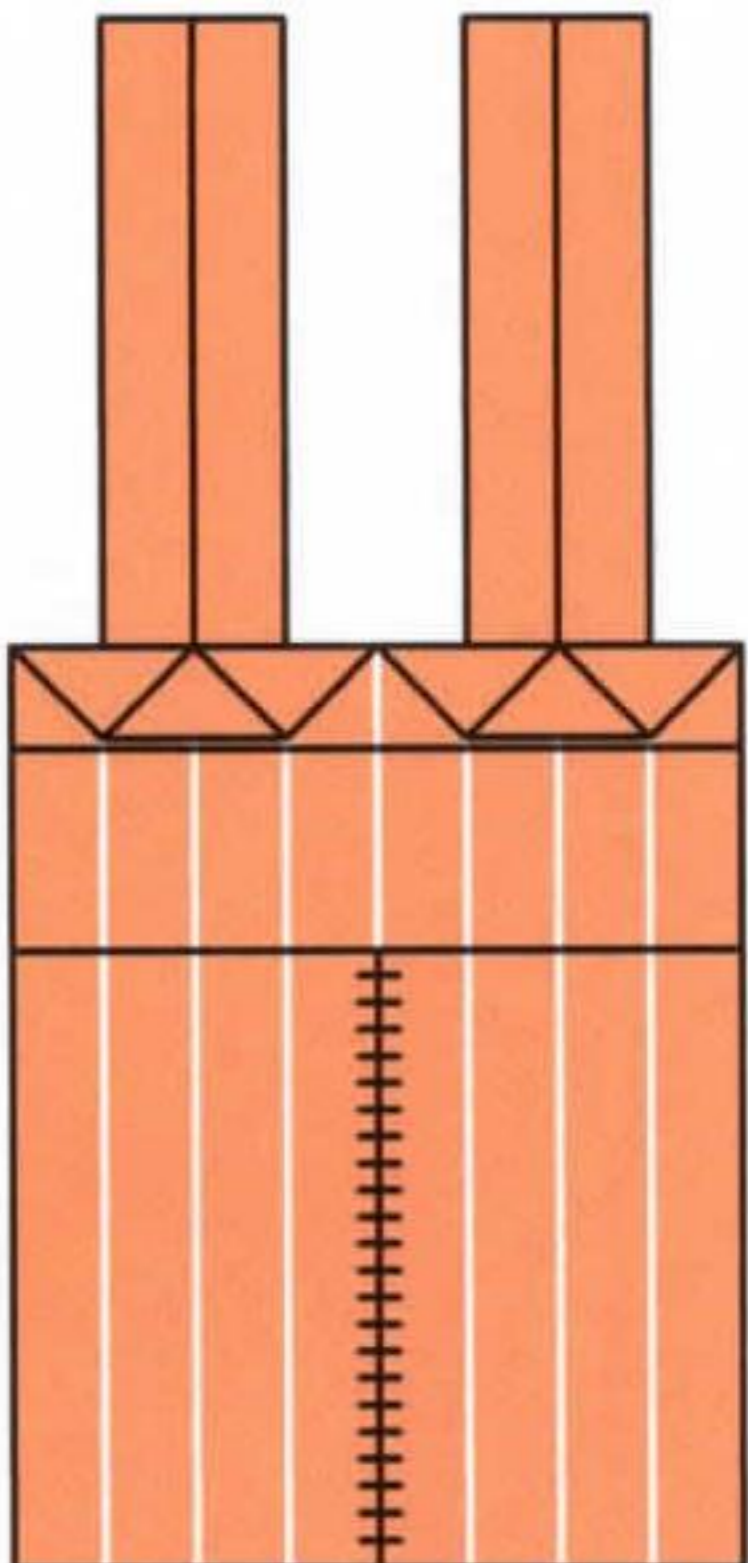

18. Cut as shown

loung chair

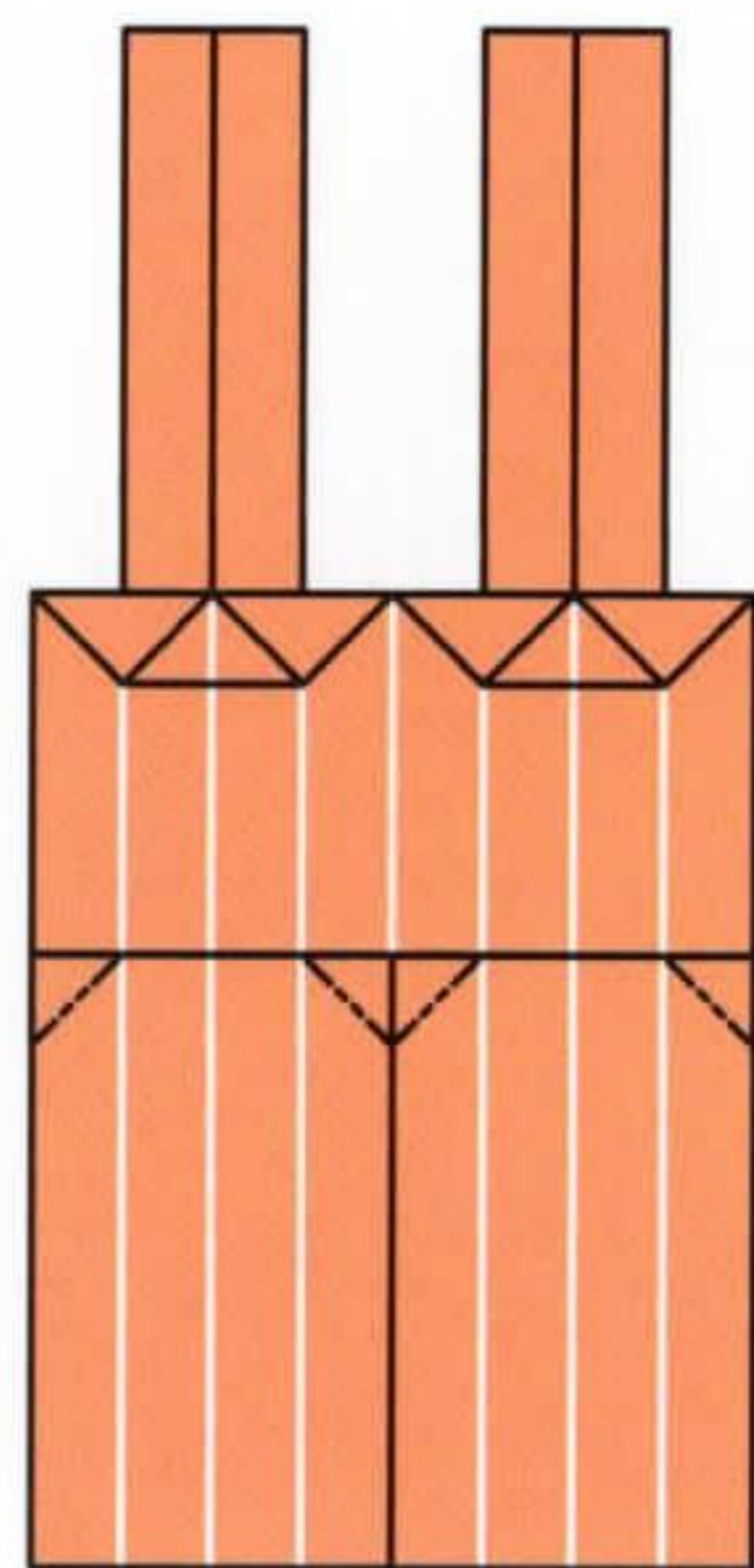

19. Inside reverse folds

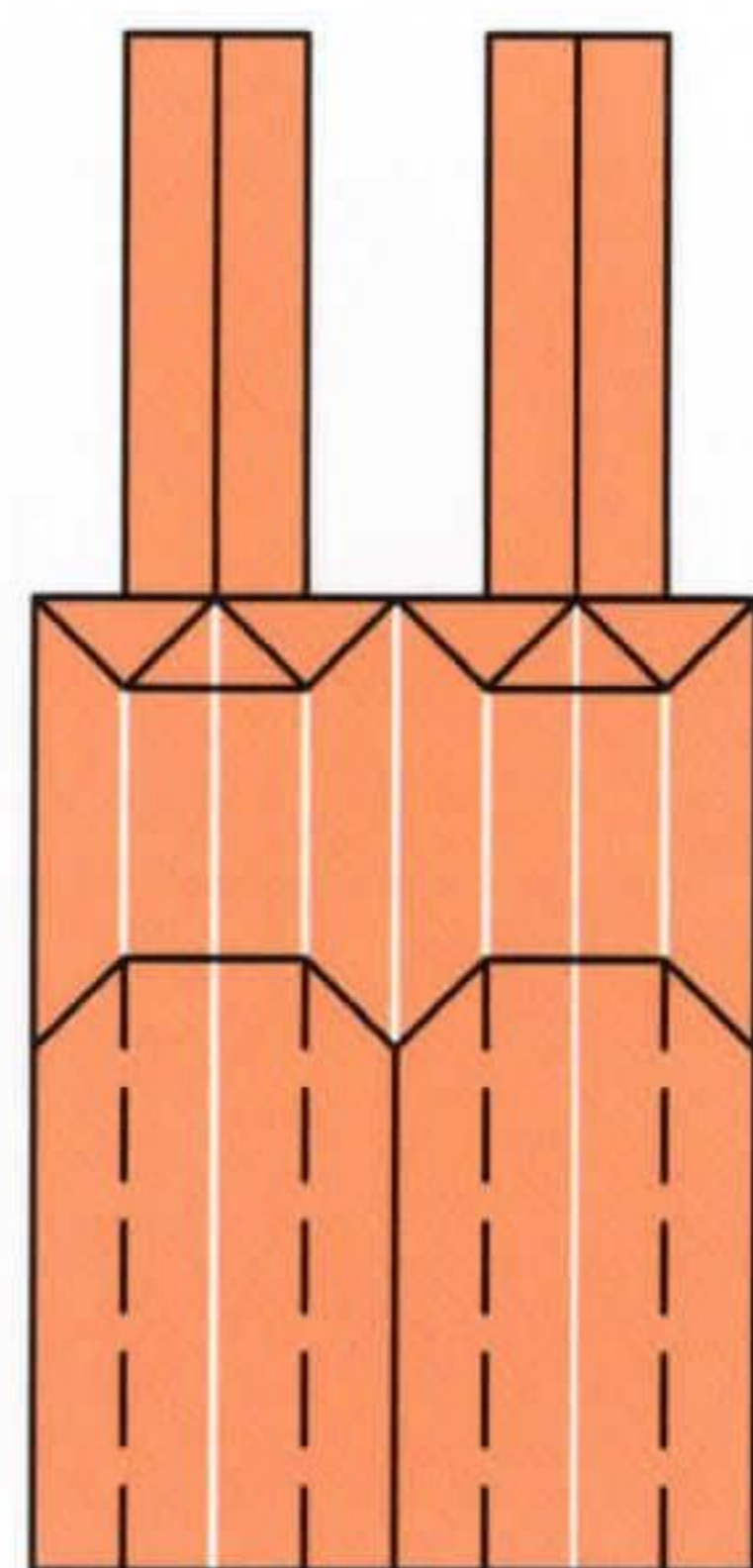

20. Valley folds

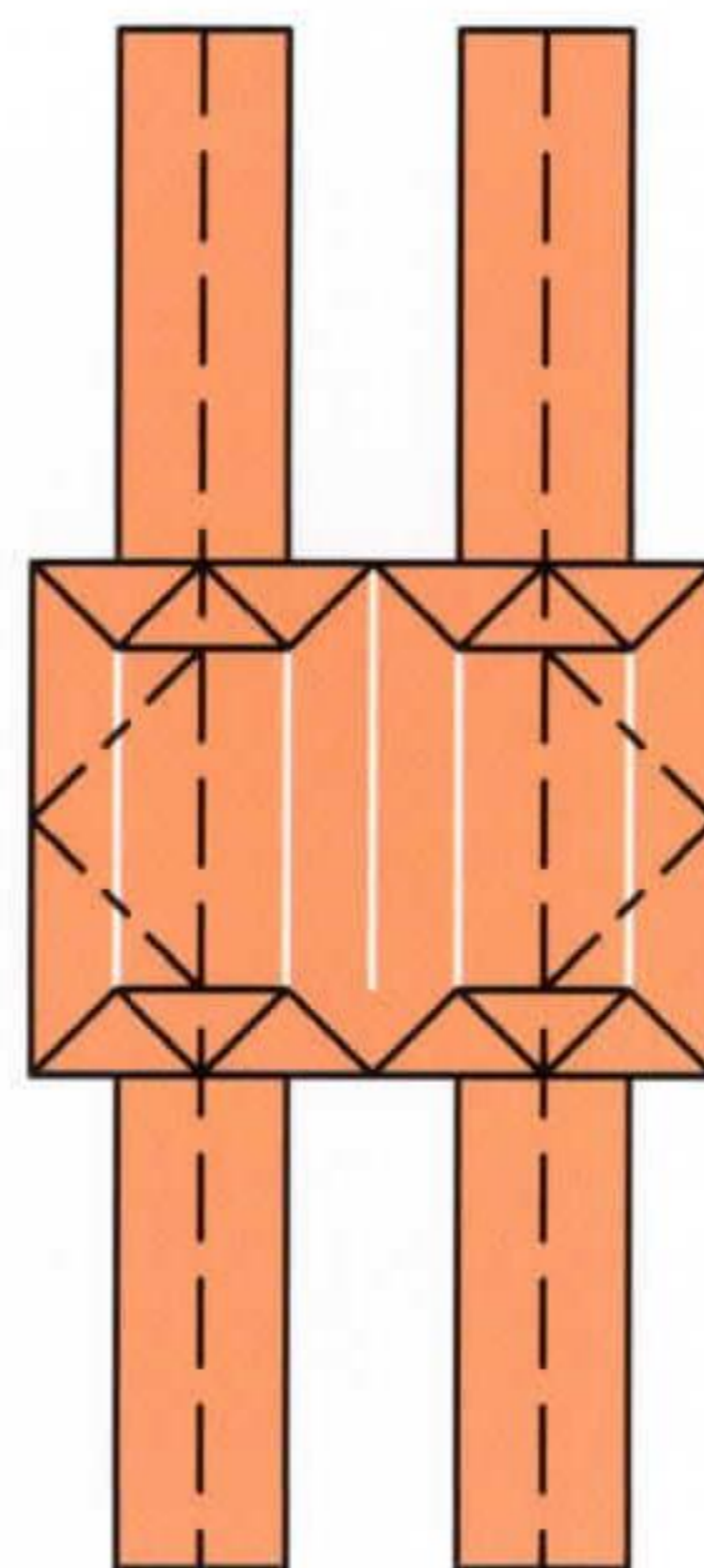

21. Valley folds and squash folds

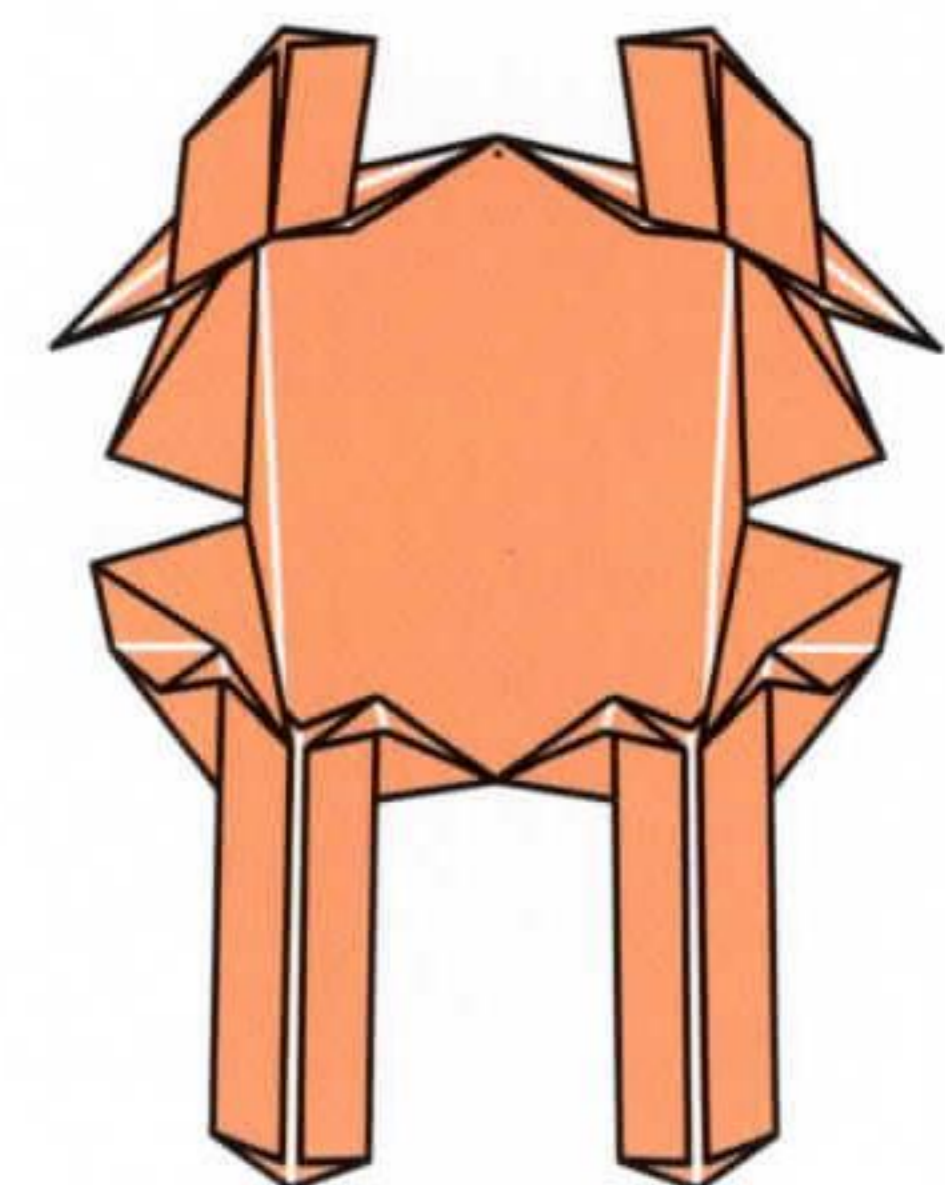

22. Before complete

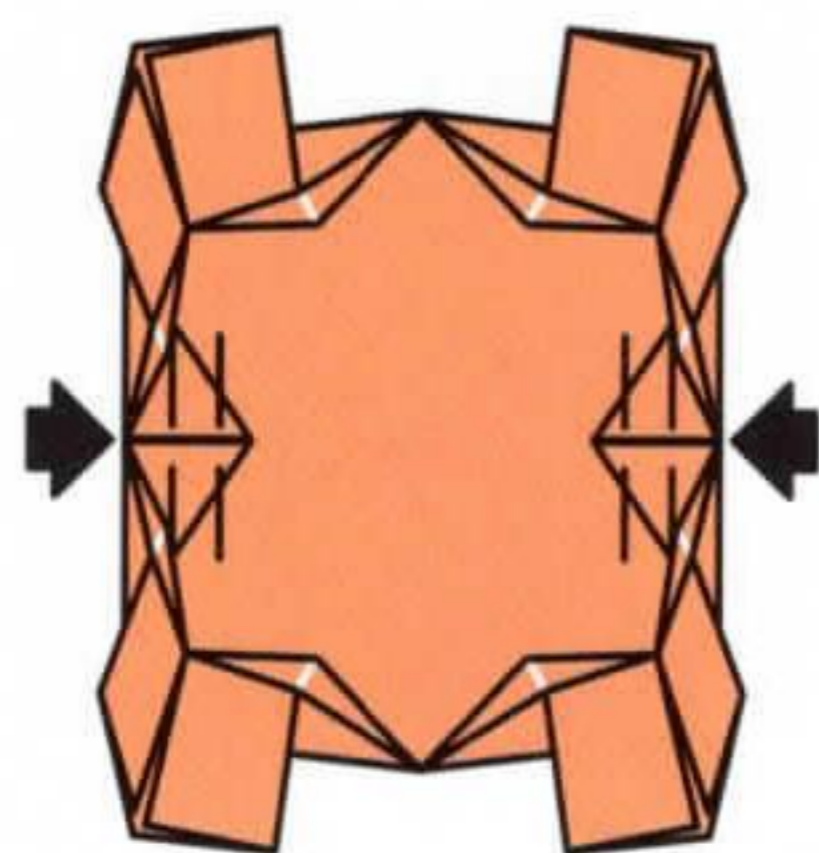

23. Valley folds, then apply glue

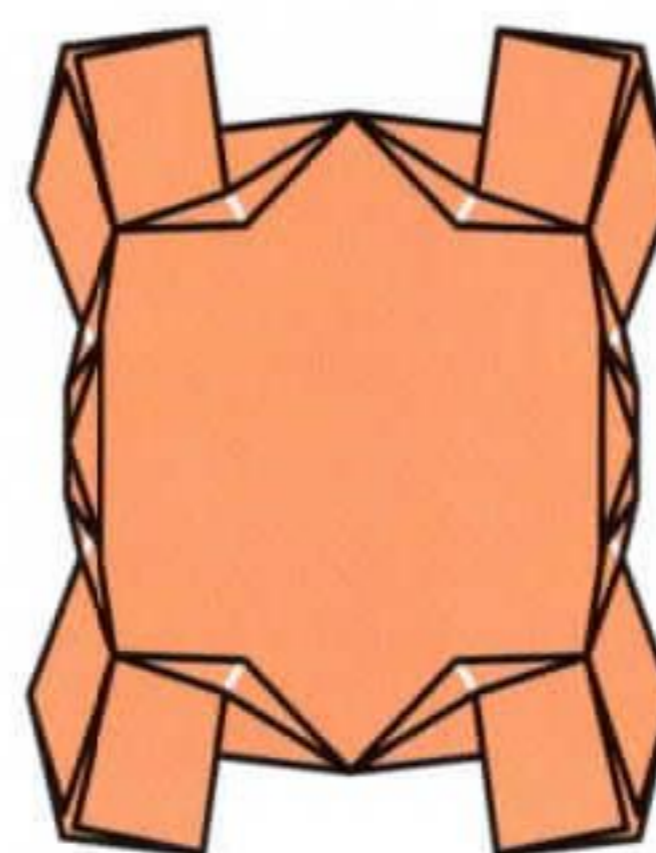

24. Turn over and rotate

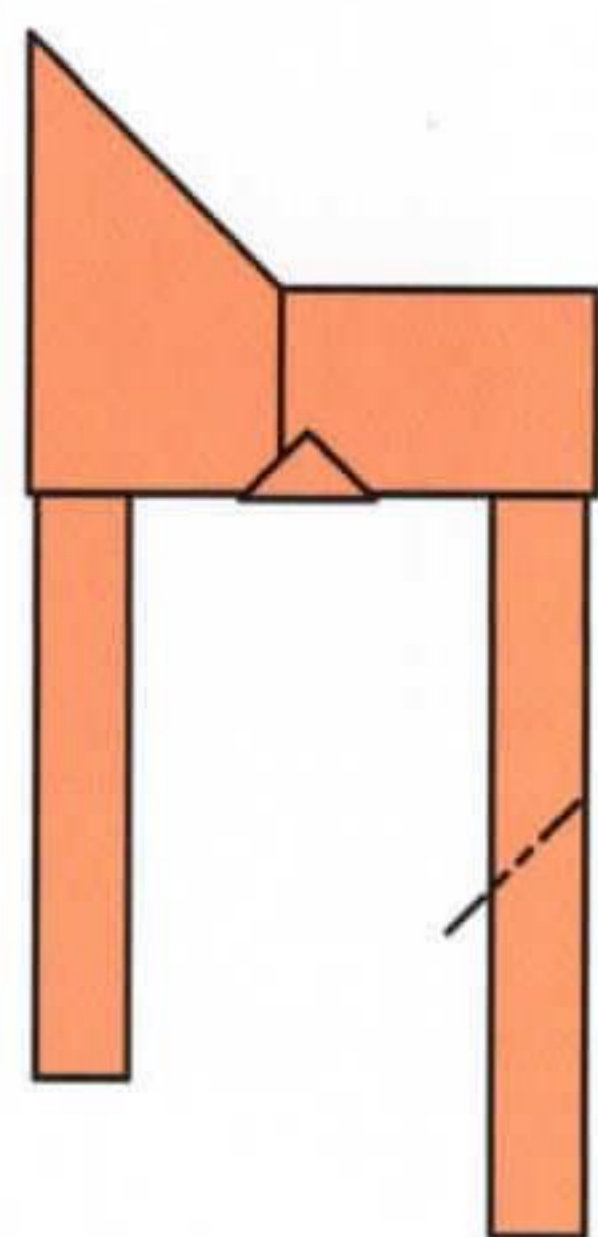

25. Inside reverse fold

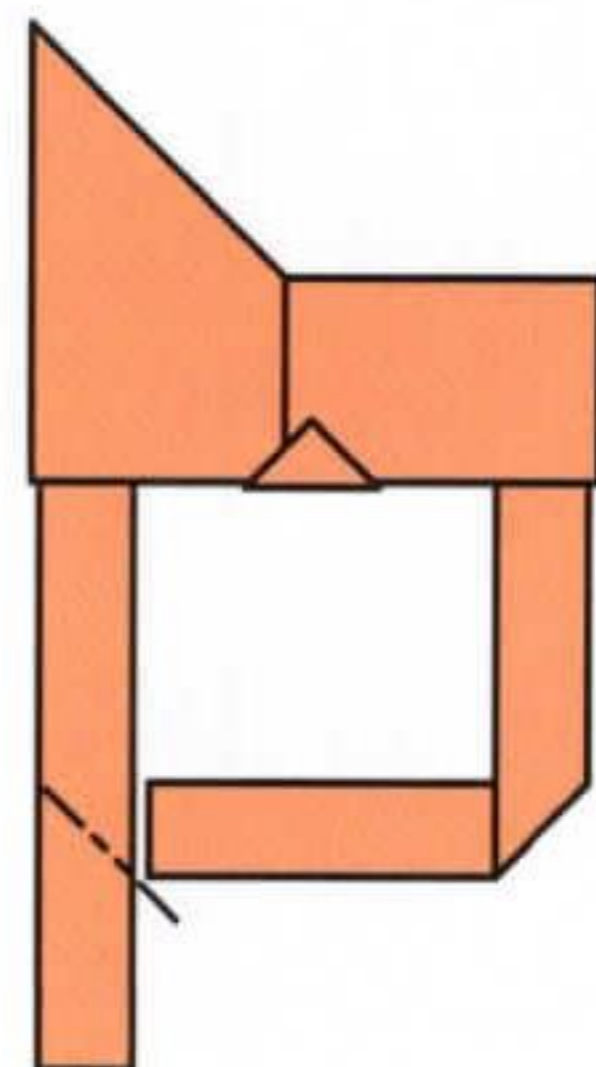

26. Repeat

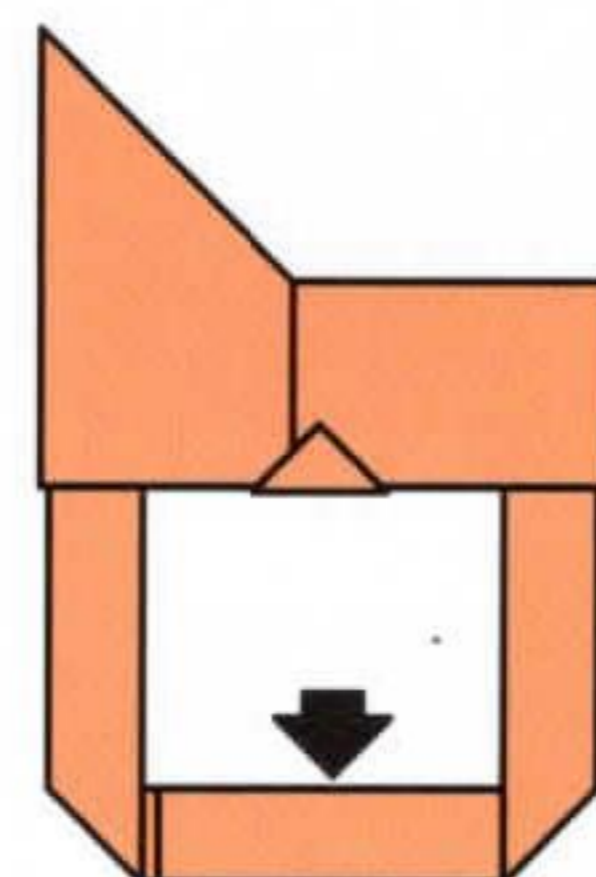

27. Apply glue

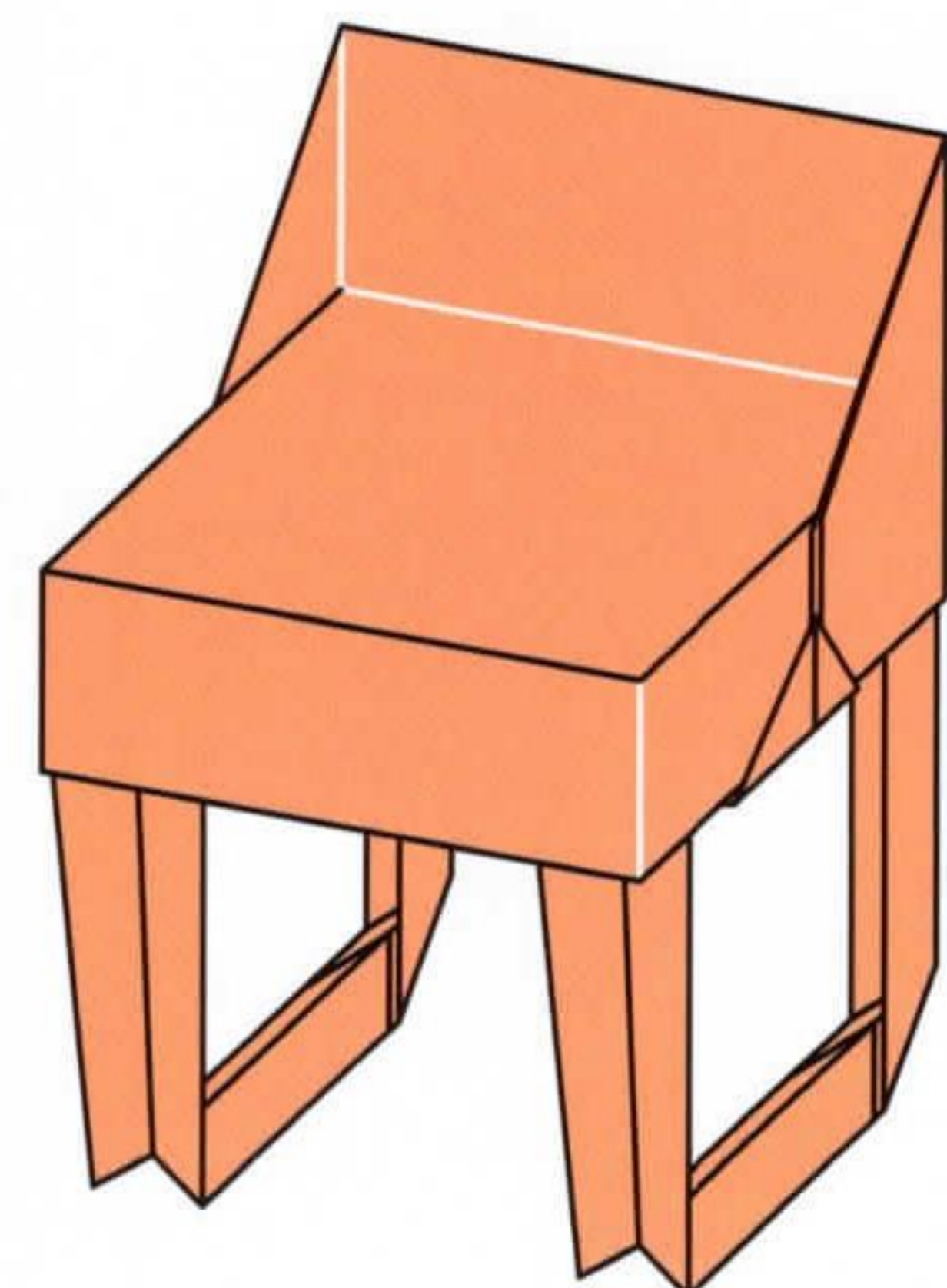

28. Completed LOUNGE CHAIR

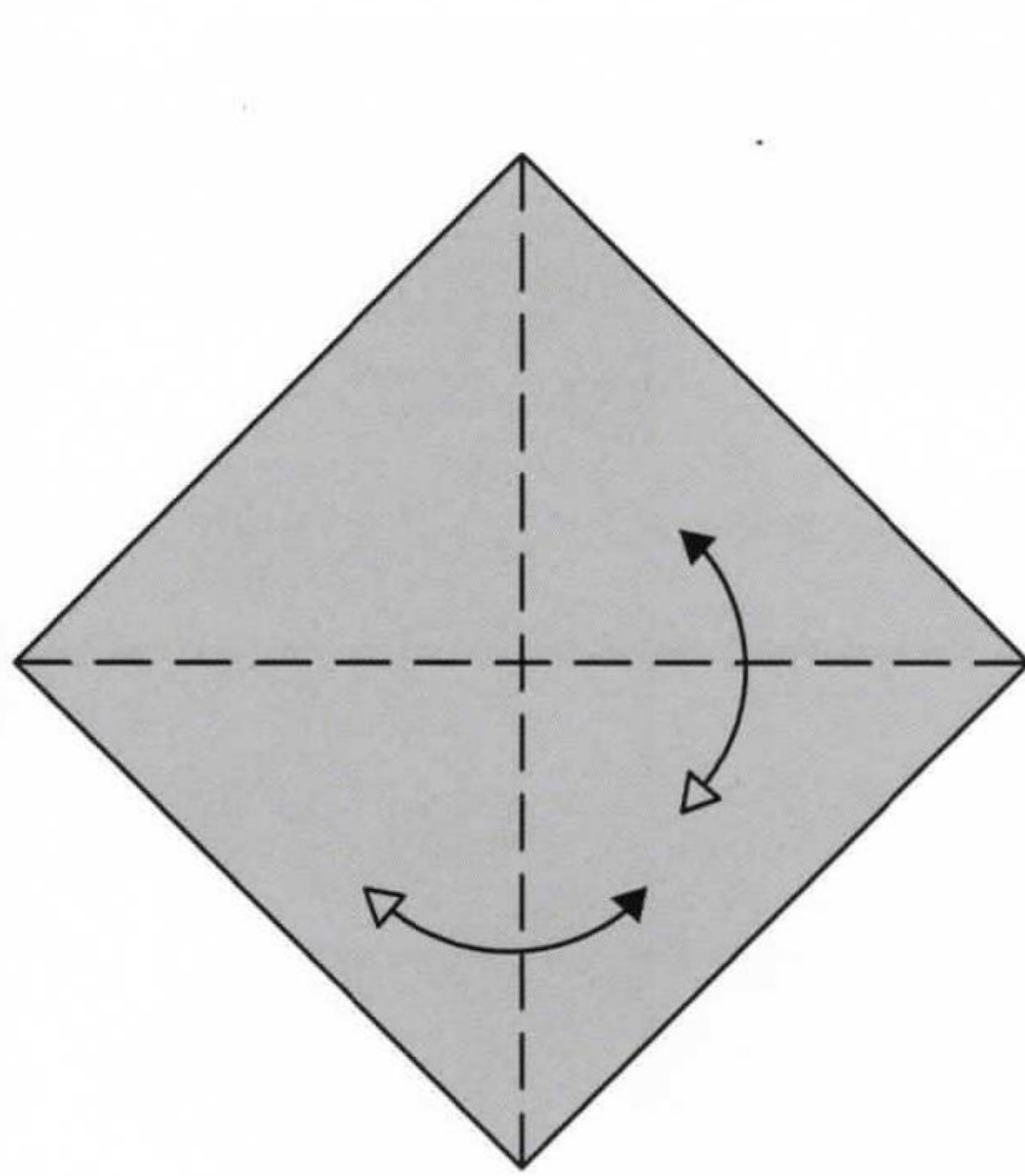

1. Valley folds and unfold

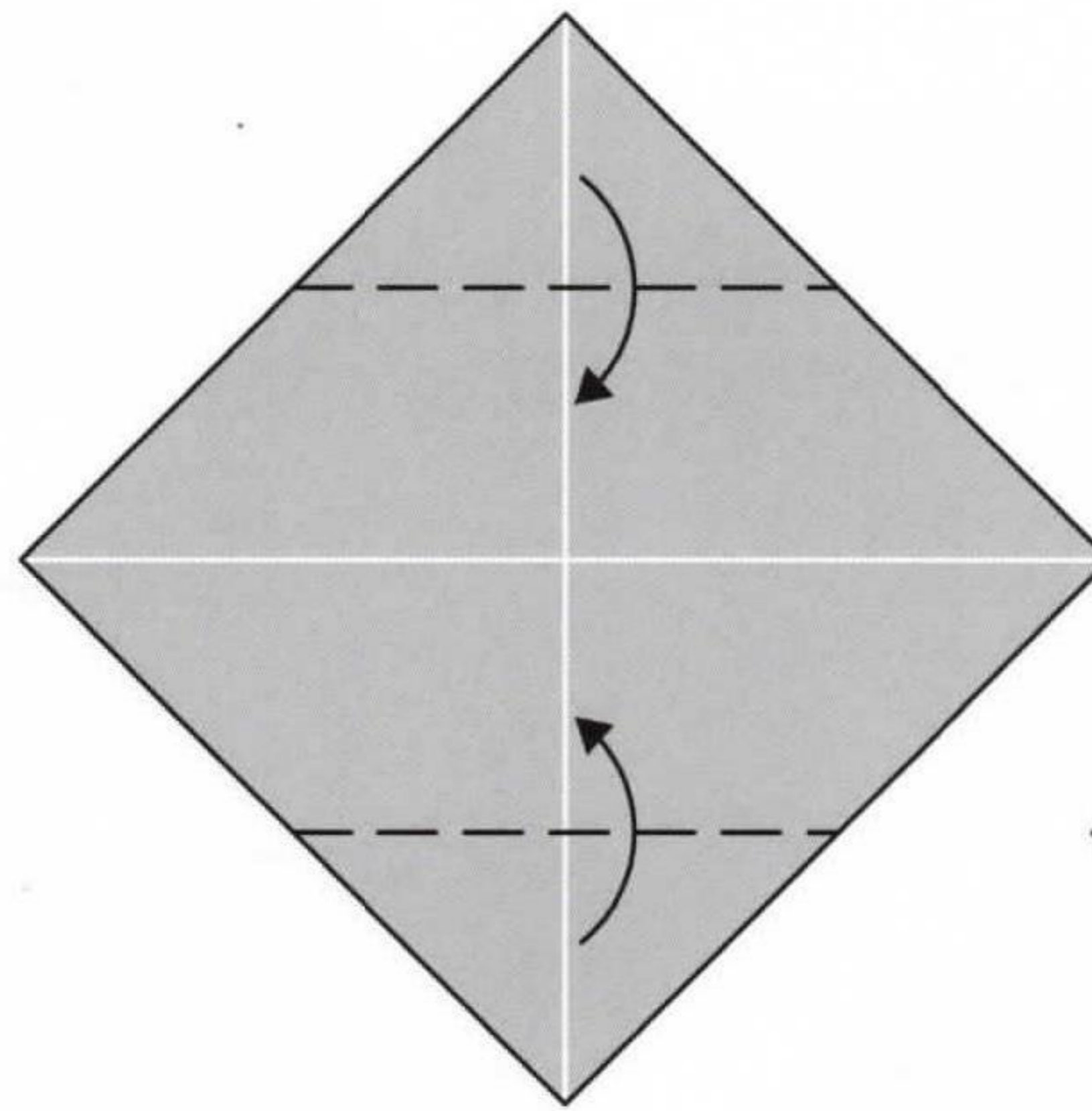

2. Valley folds

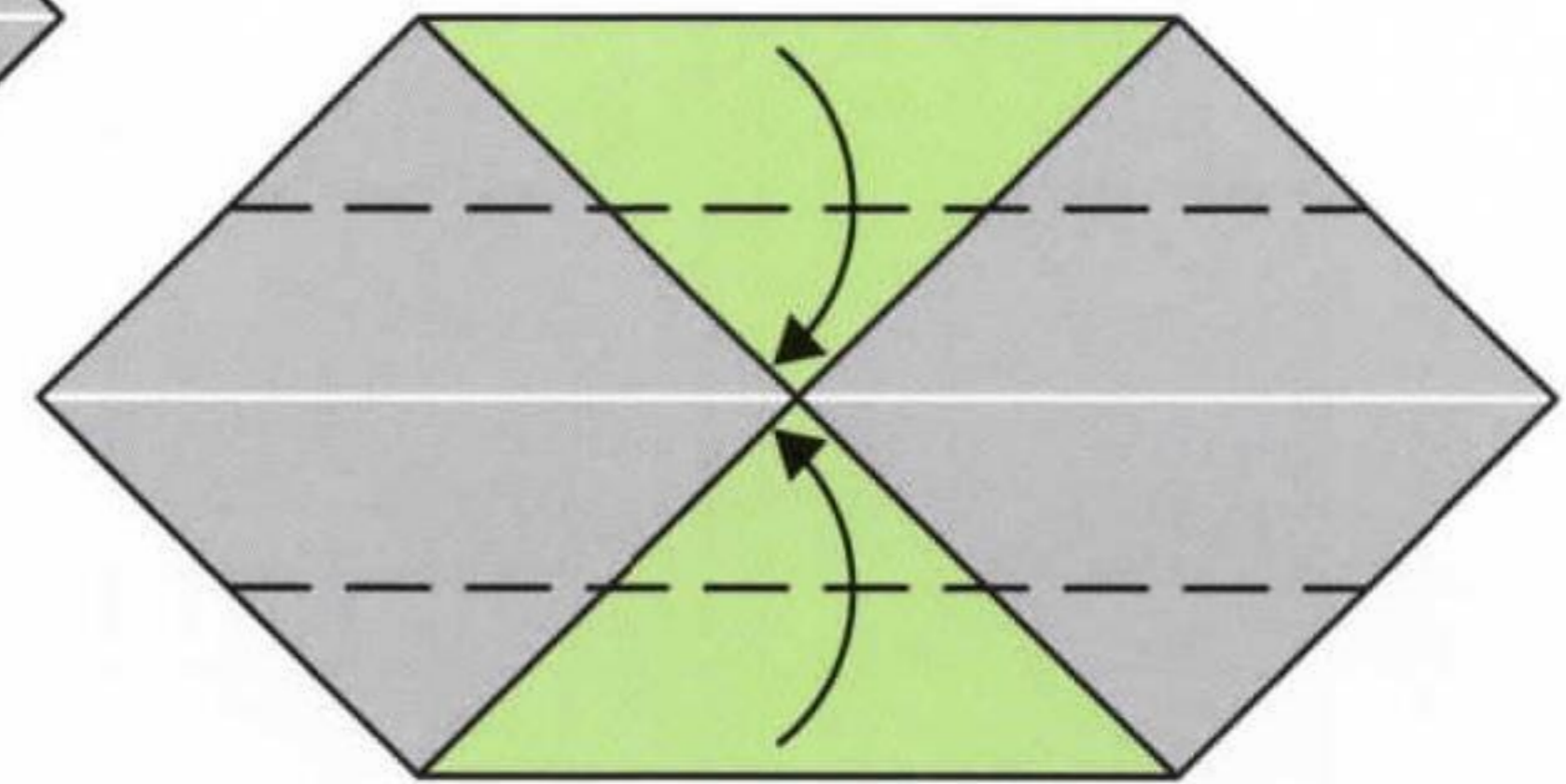

3. Valley folds

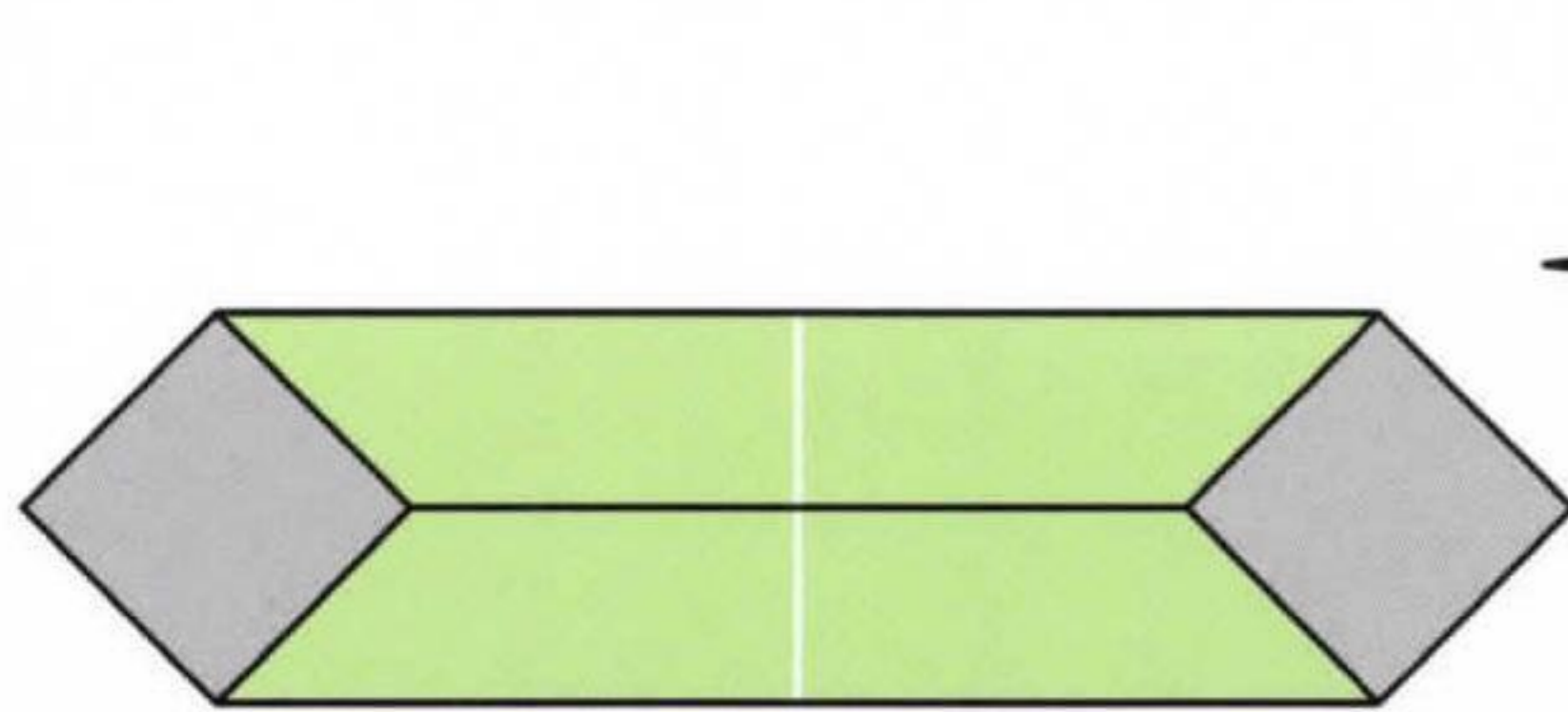

4. Scale-up

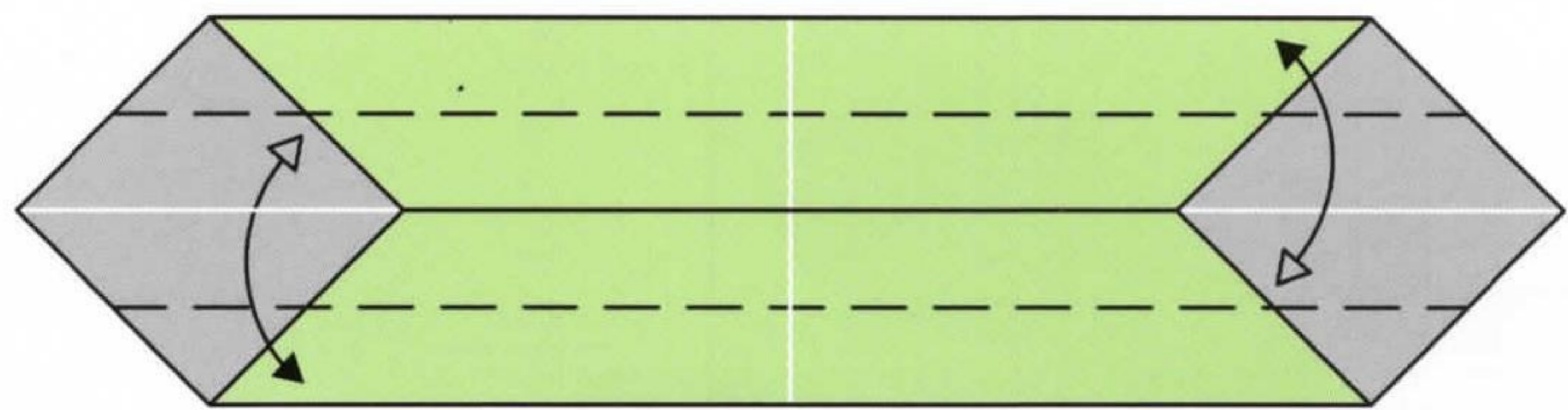

5. Valley folds and unfold

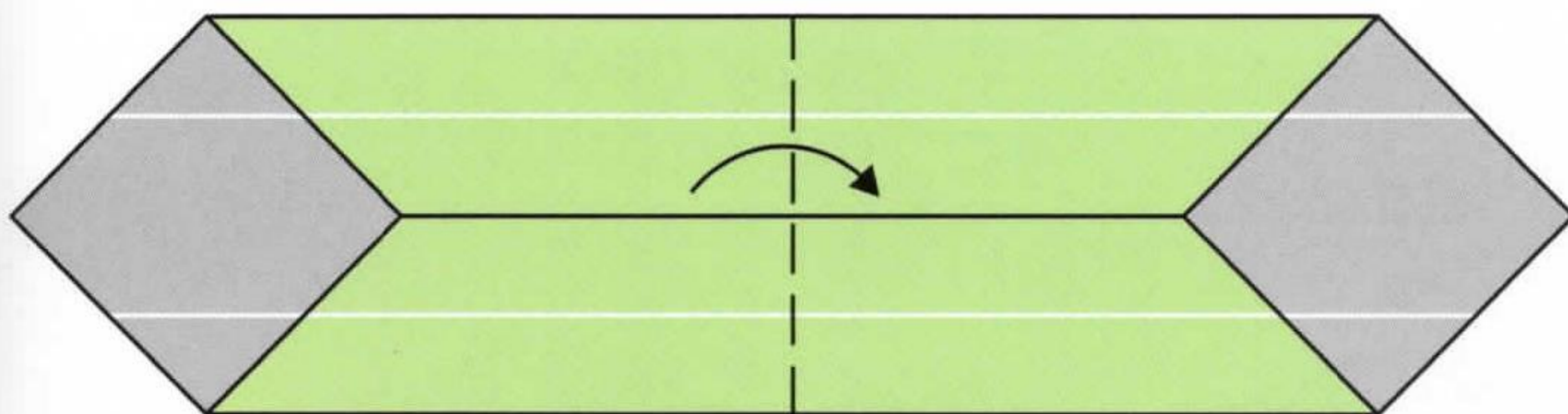

6. Valley fold

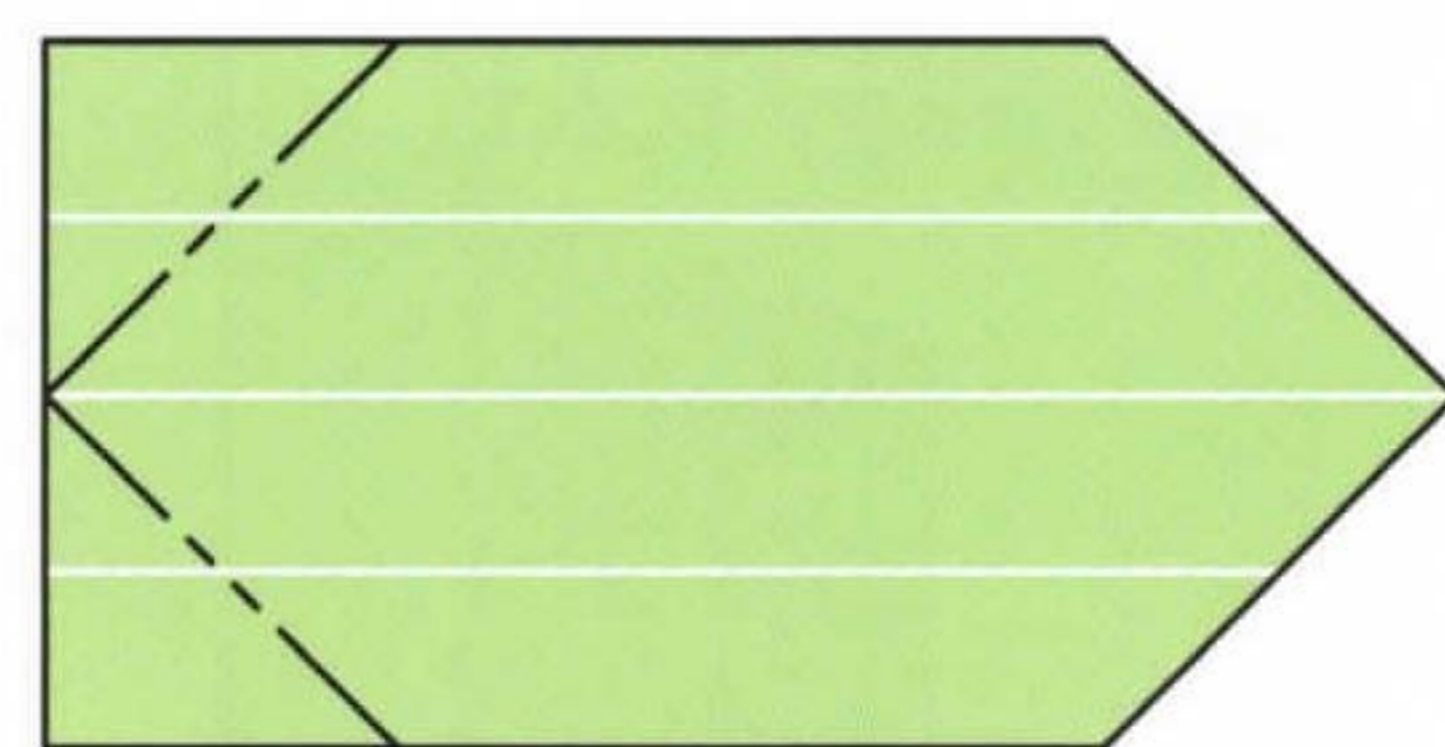

7. Inside reverse folds

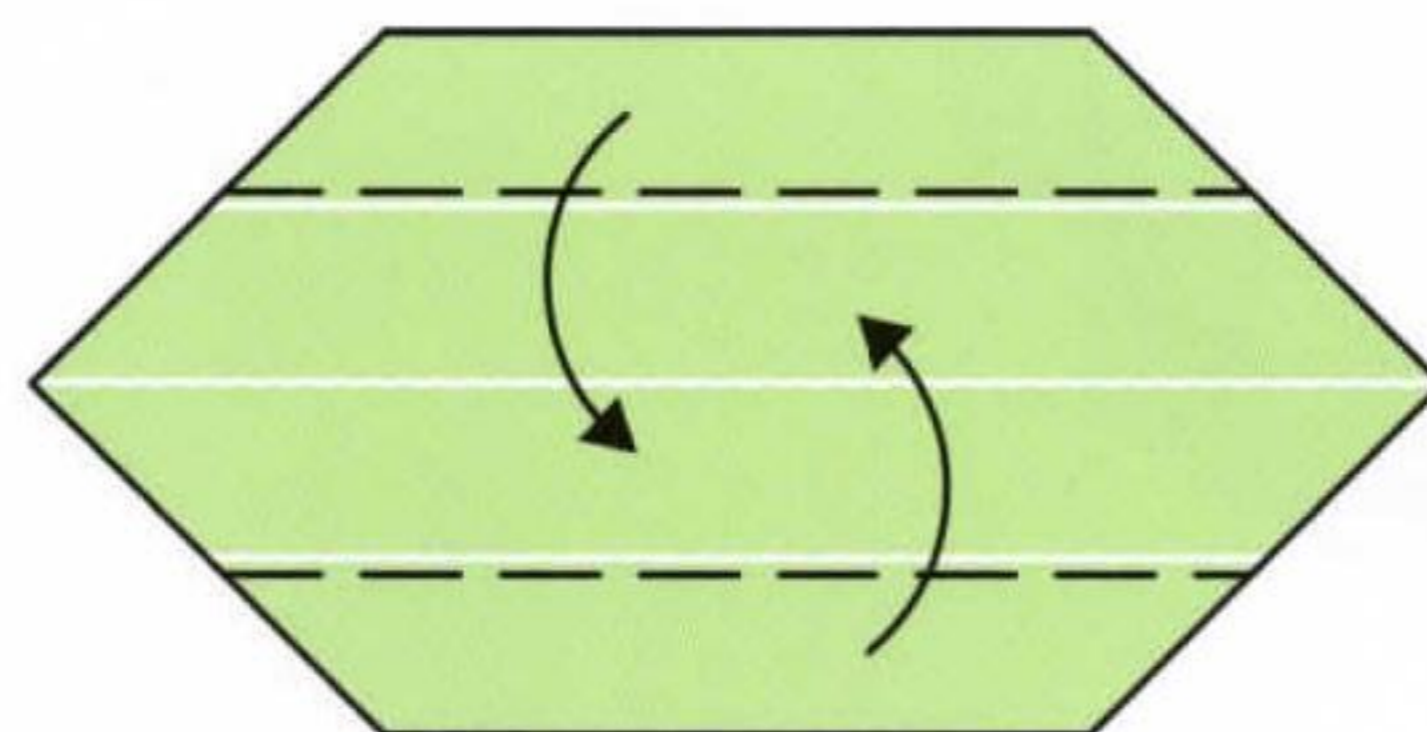

8. Valley folds

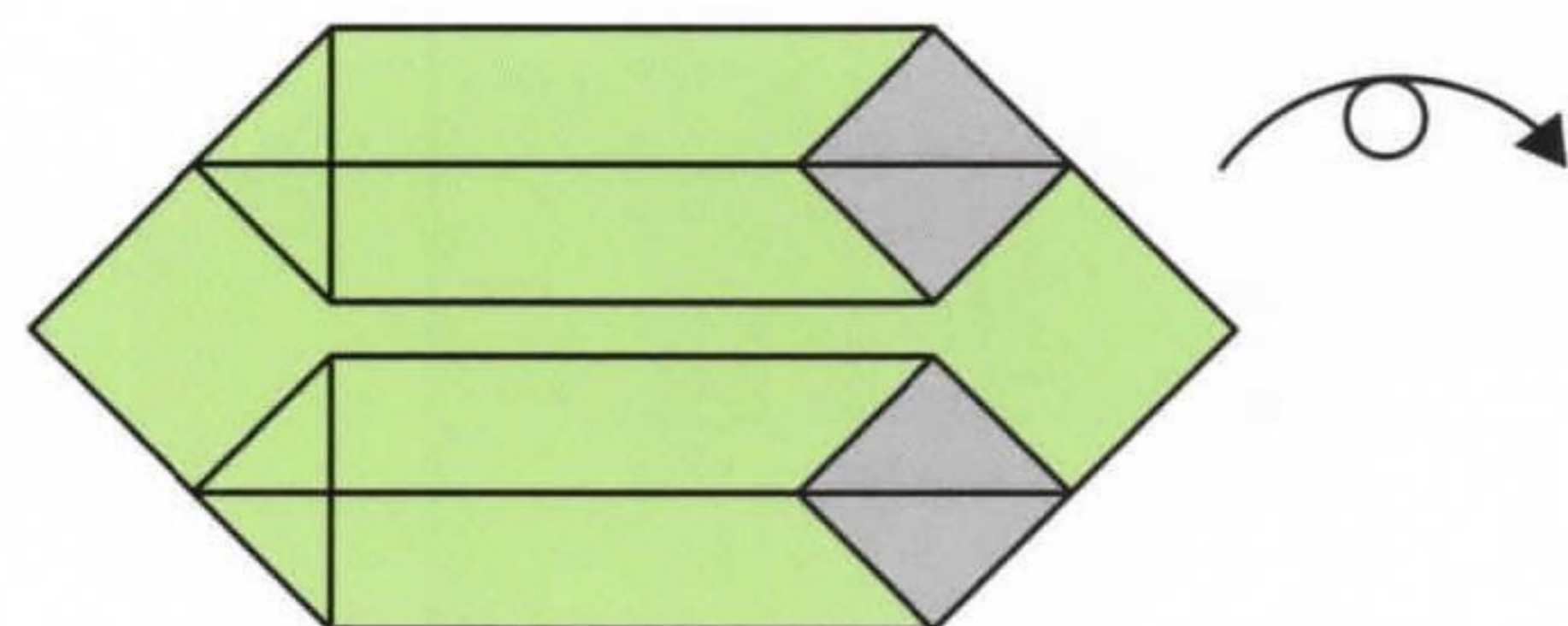

9. Turn over

computer desk: part 1

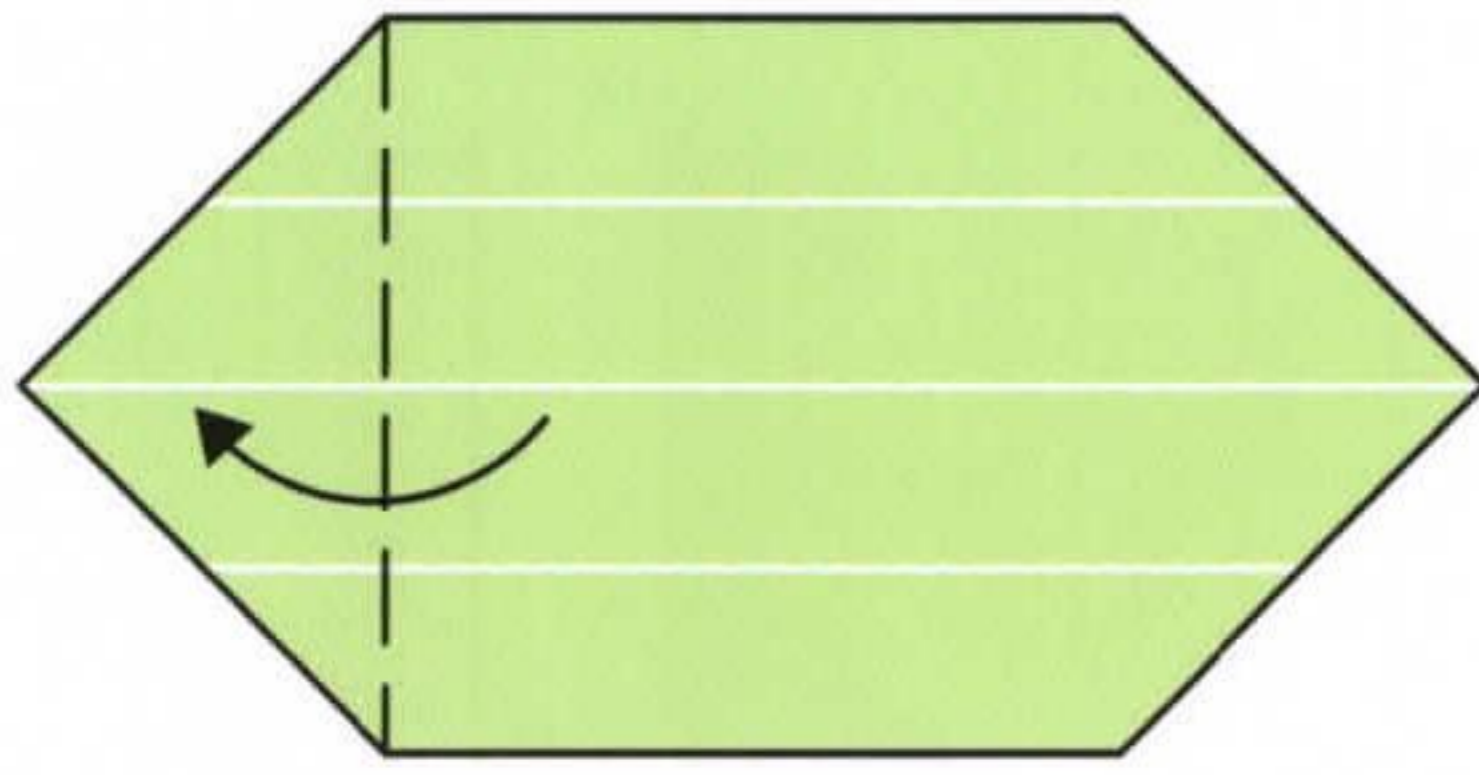

10. Valley fold

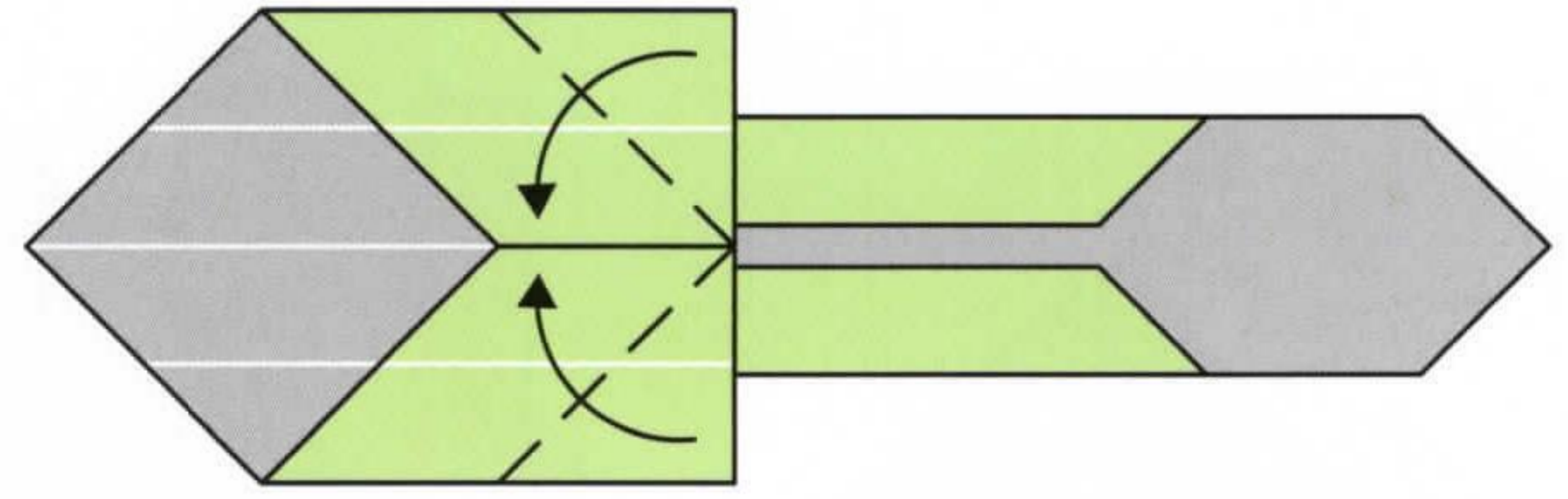

11. Valley folds

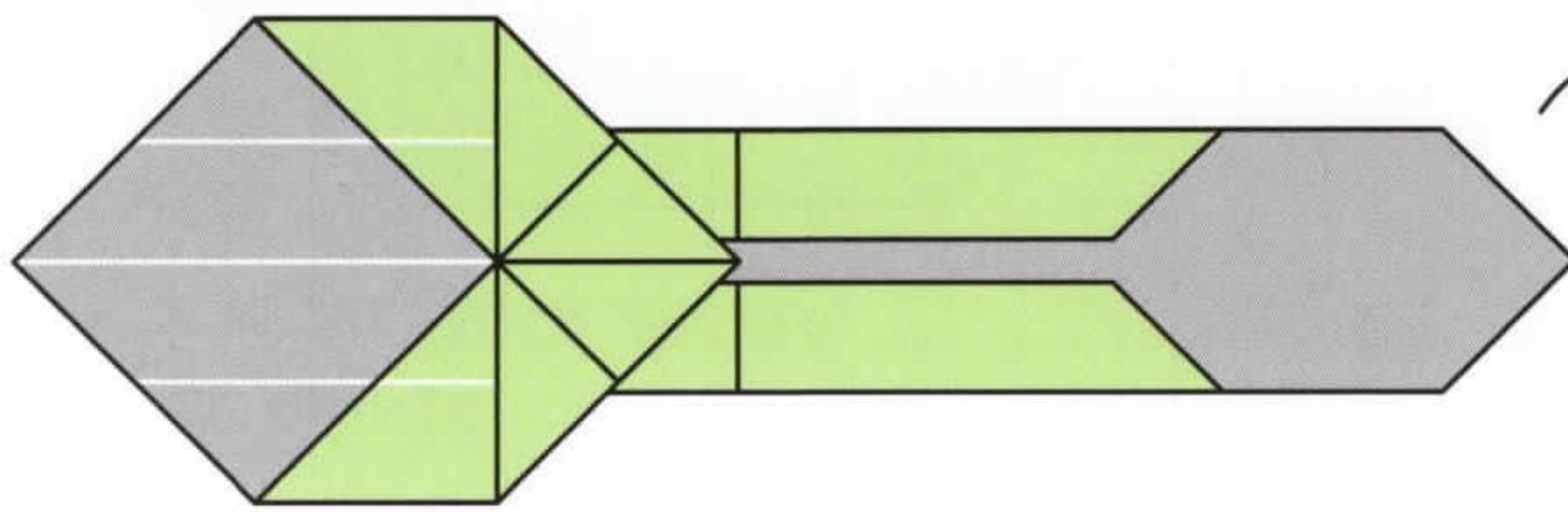

12. Turn over

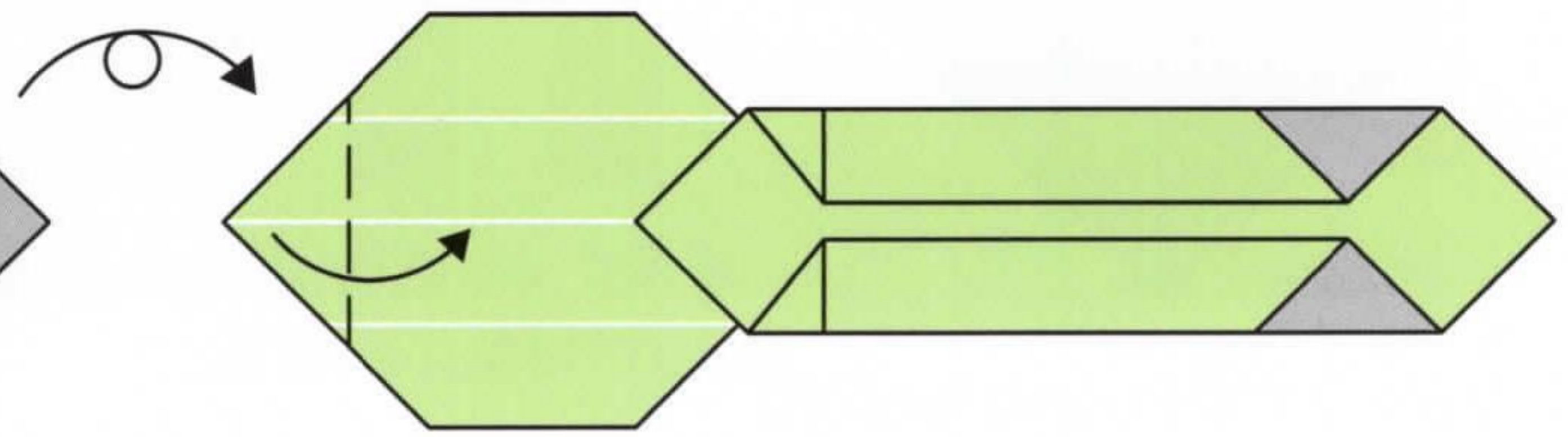

13. Valley fold

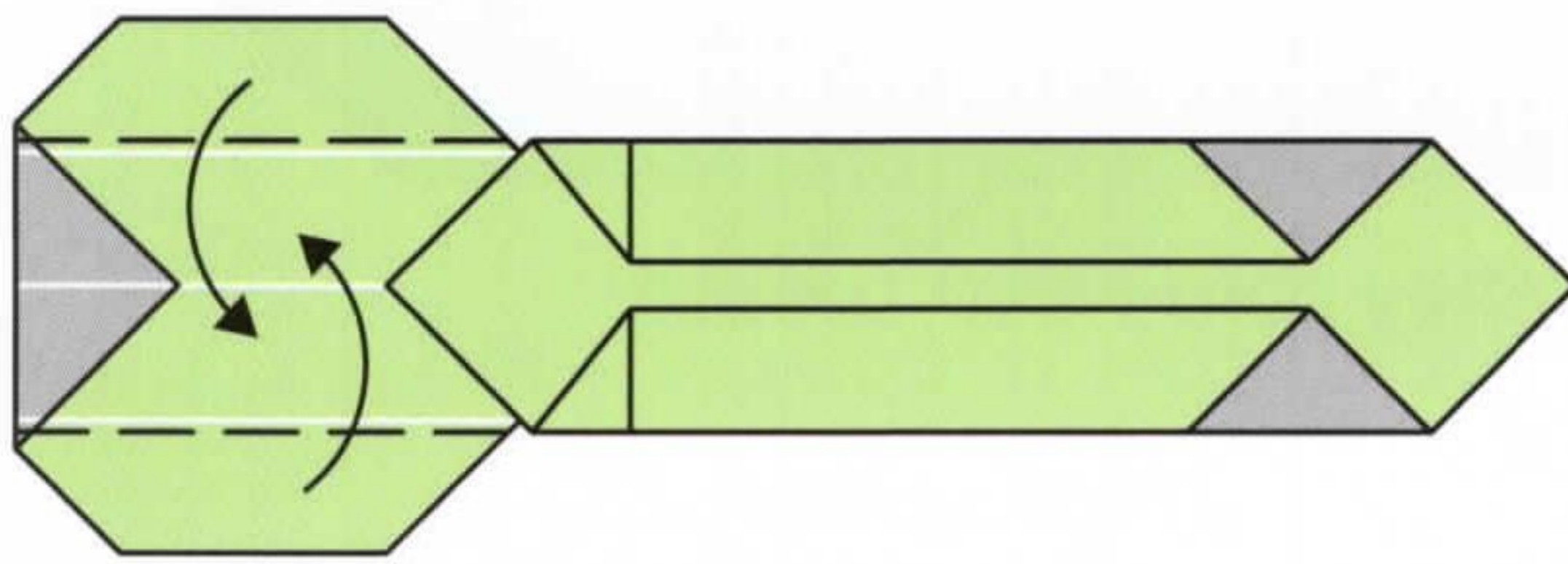

14. Valley folds

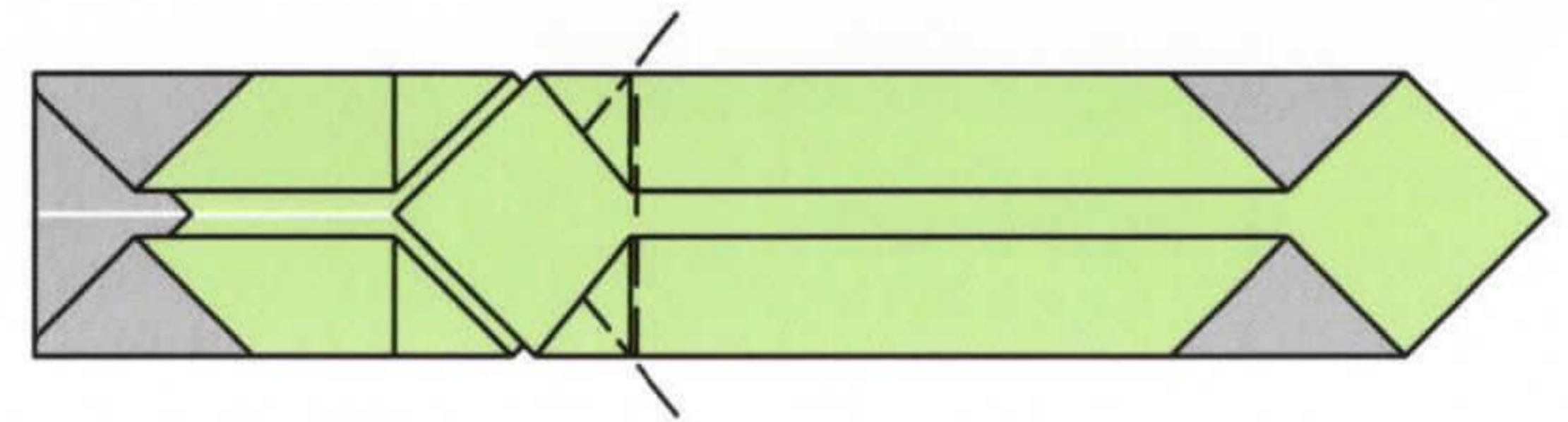

15. Valley fold
and Squash folds

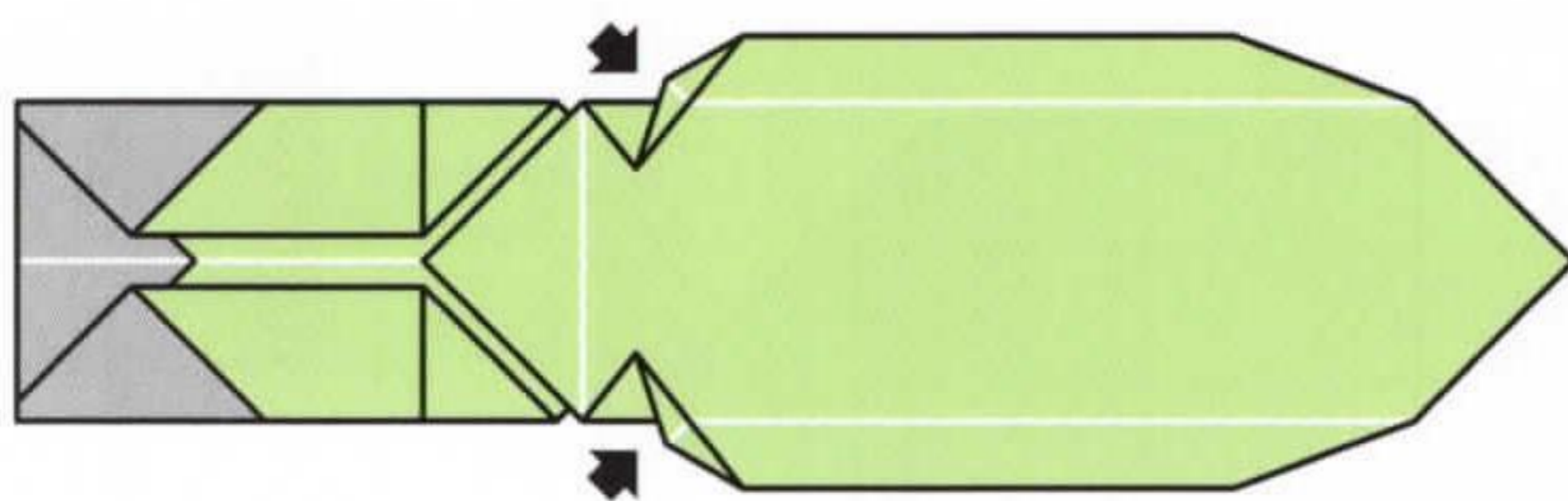

16. Almost complete
Add glue to hold

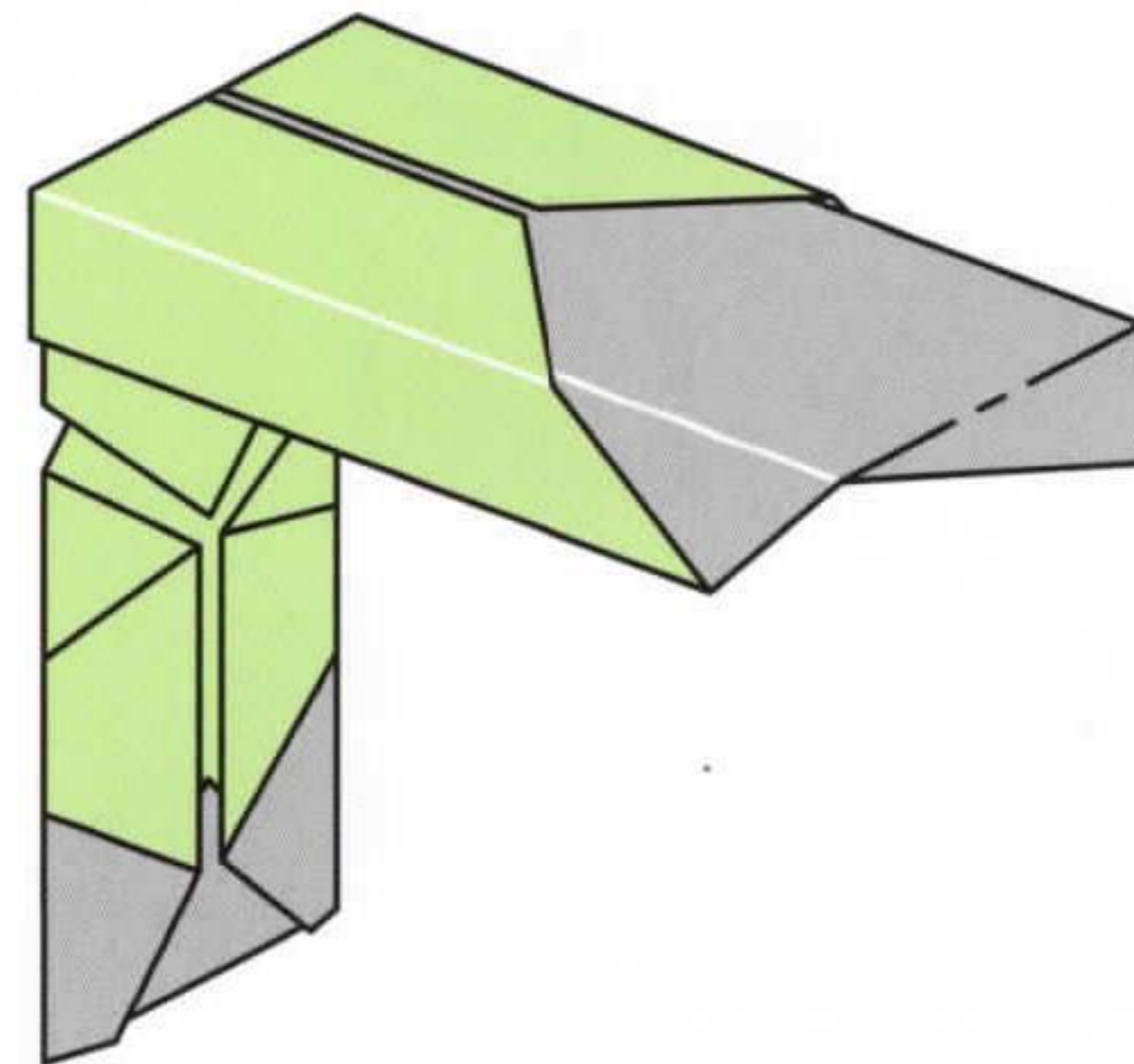

17. Mountain fold

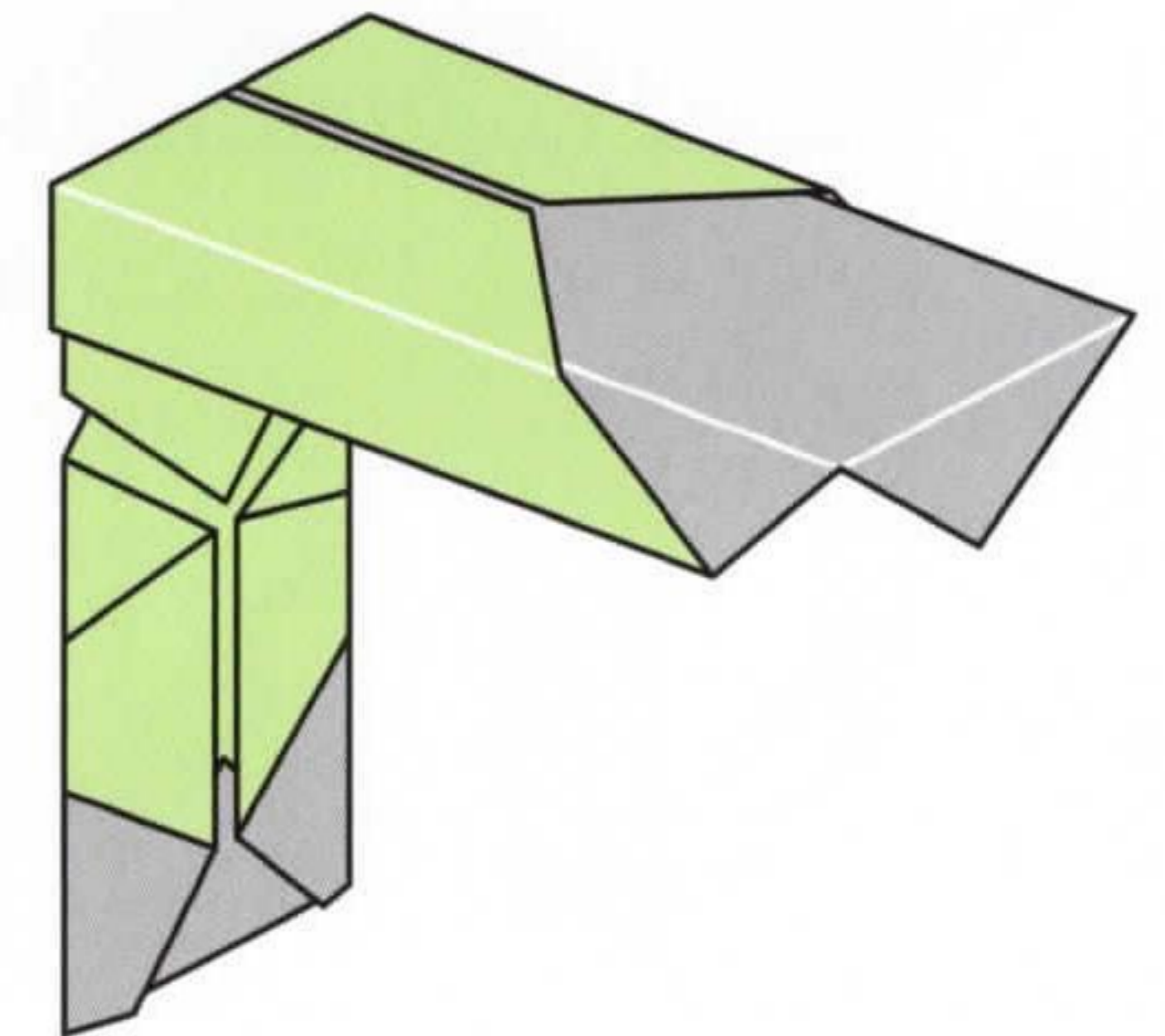

18. Completed
PART I

computer desk: part 2

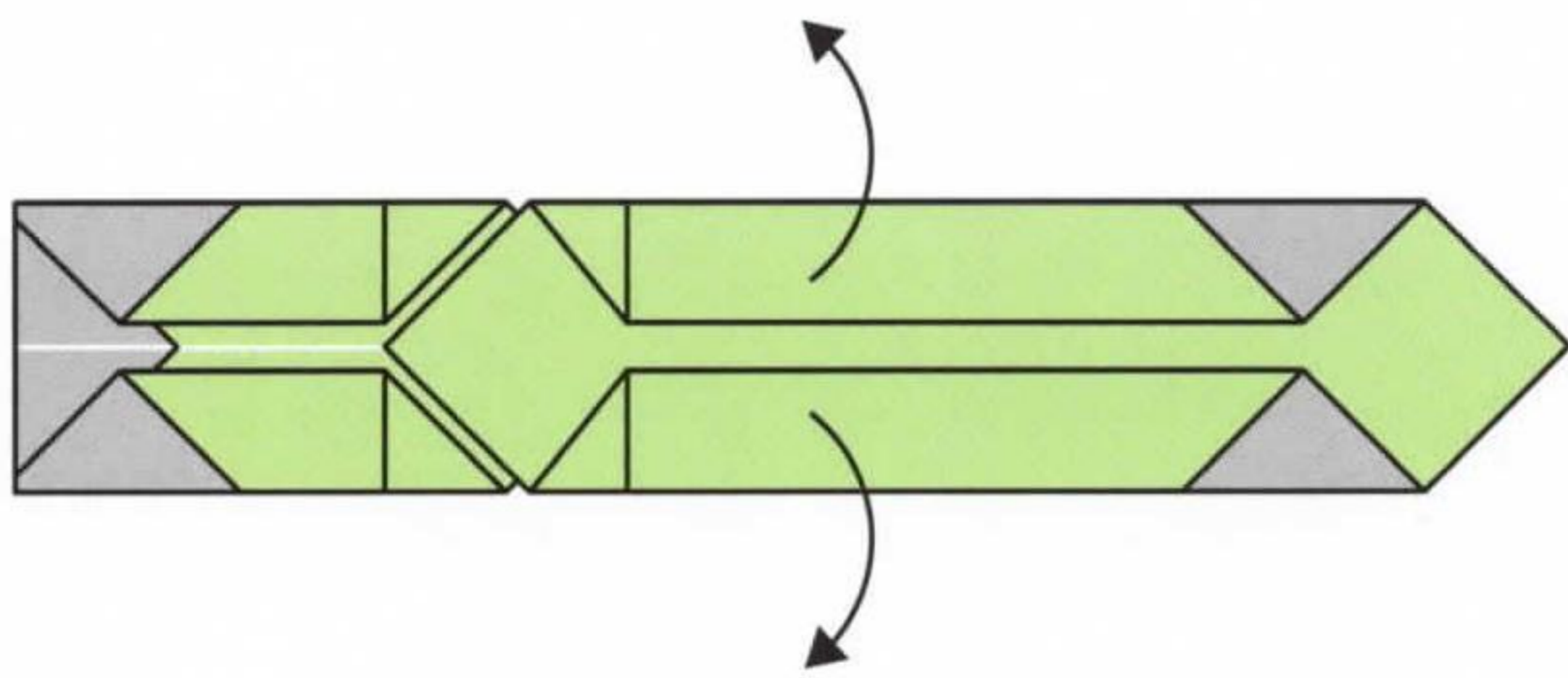

1. Complete steps 1- 15 of Part 1, then Valley folds

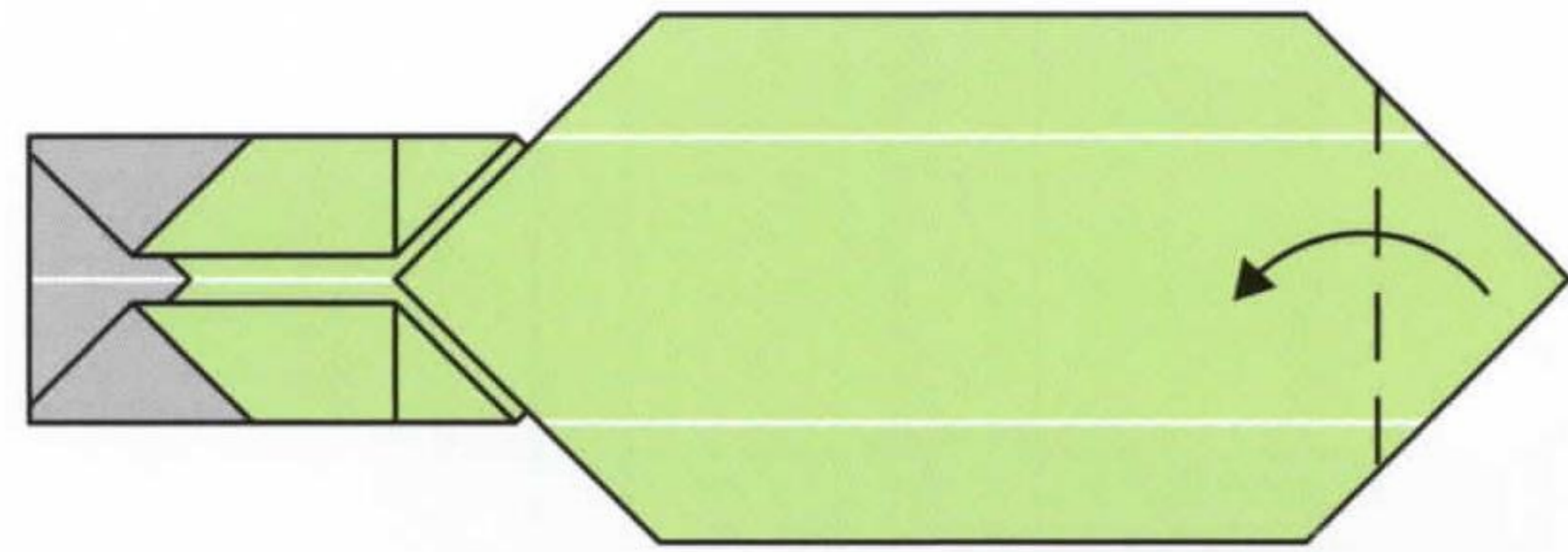

2. Valley fold

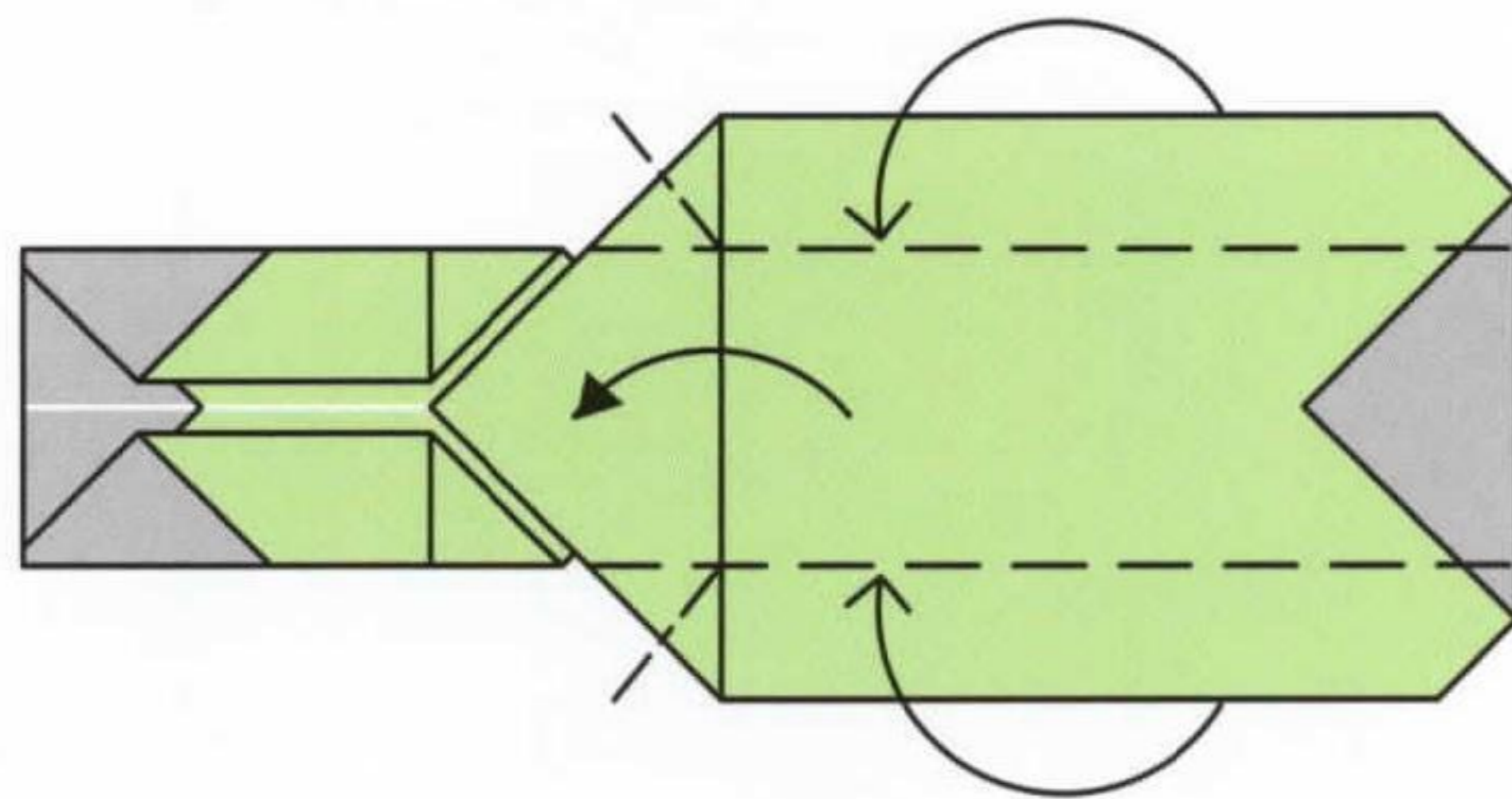

3. Valley folds and squash folds

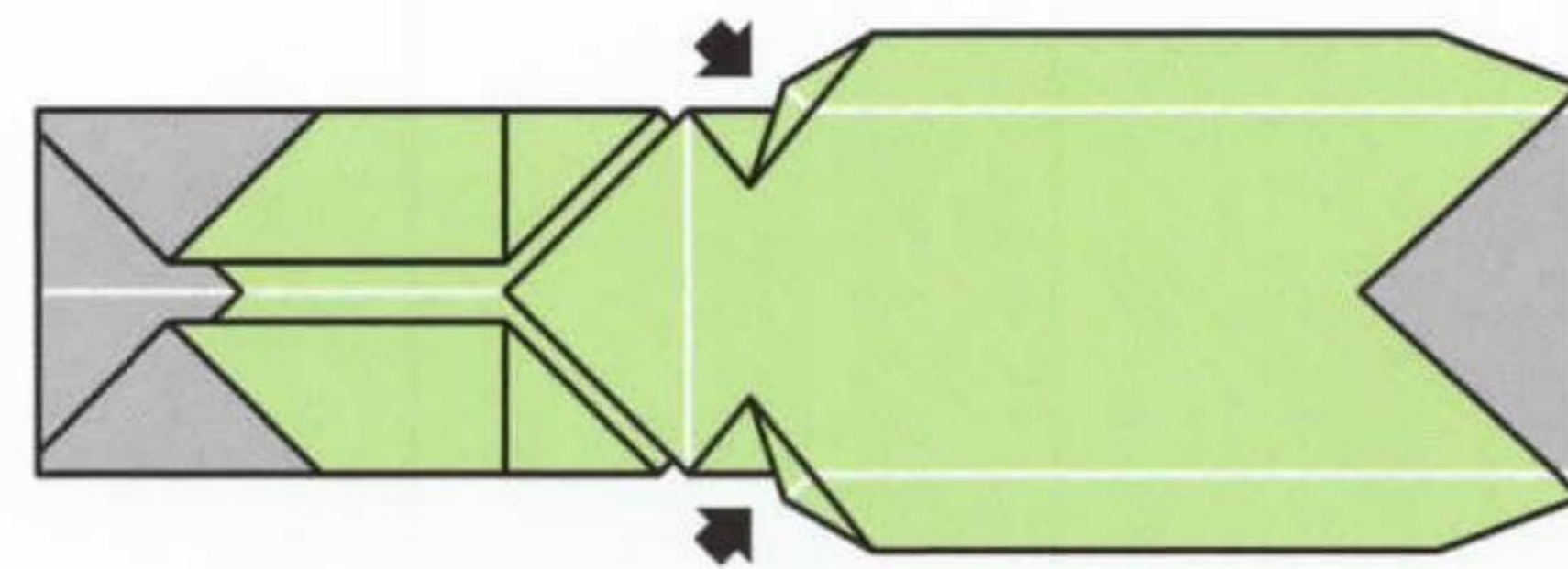

4. Before complete. Add glue to hold

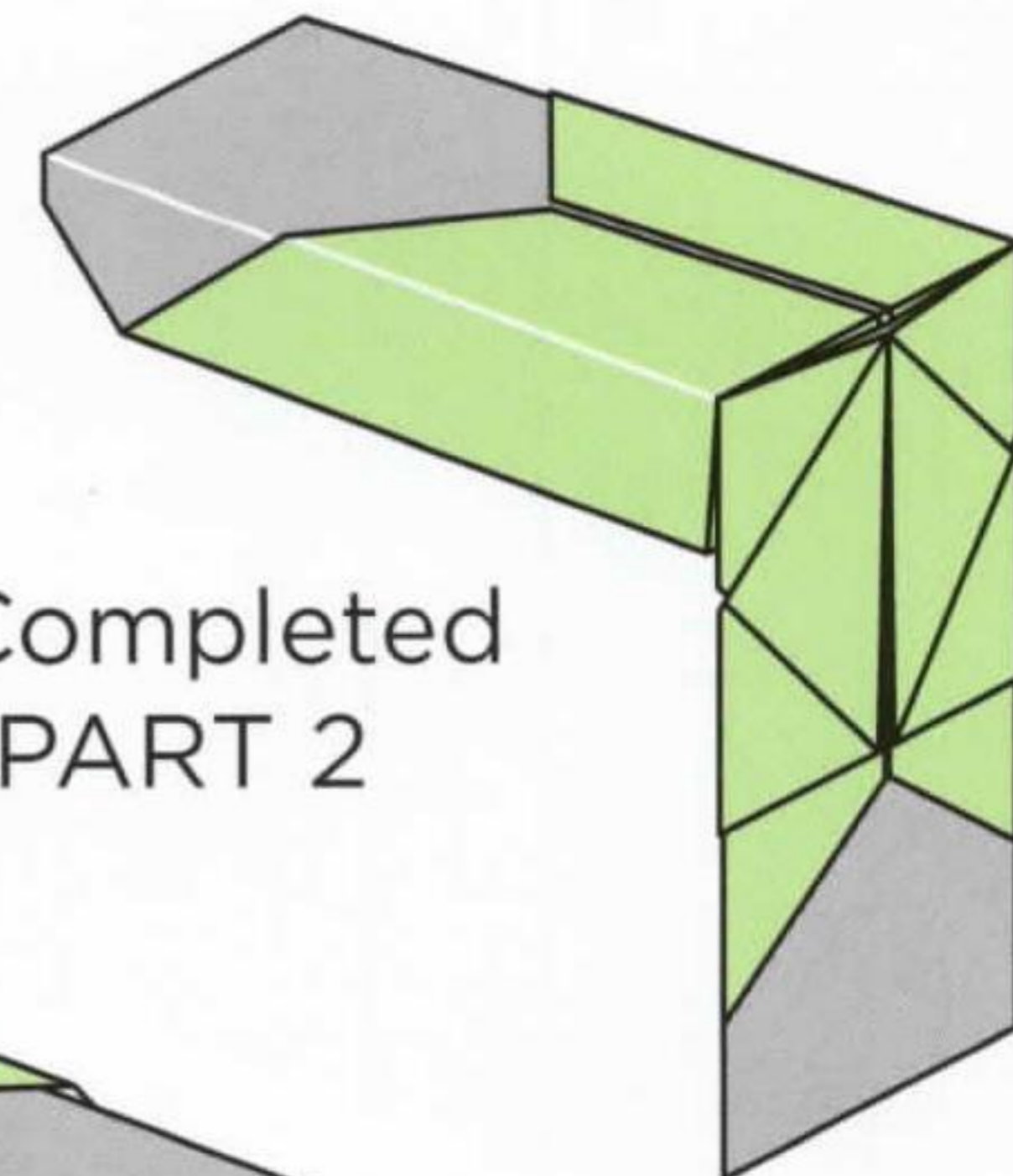

5. Completed PART 2

ASSEMBLY

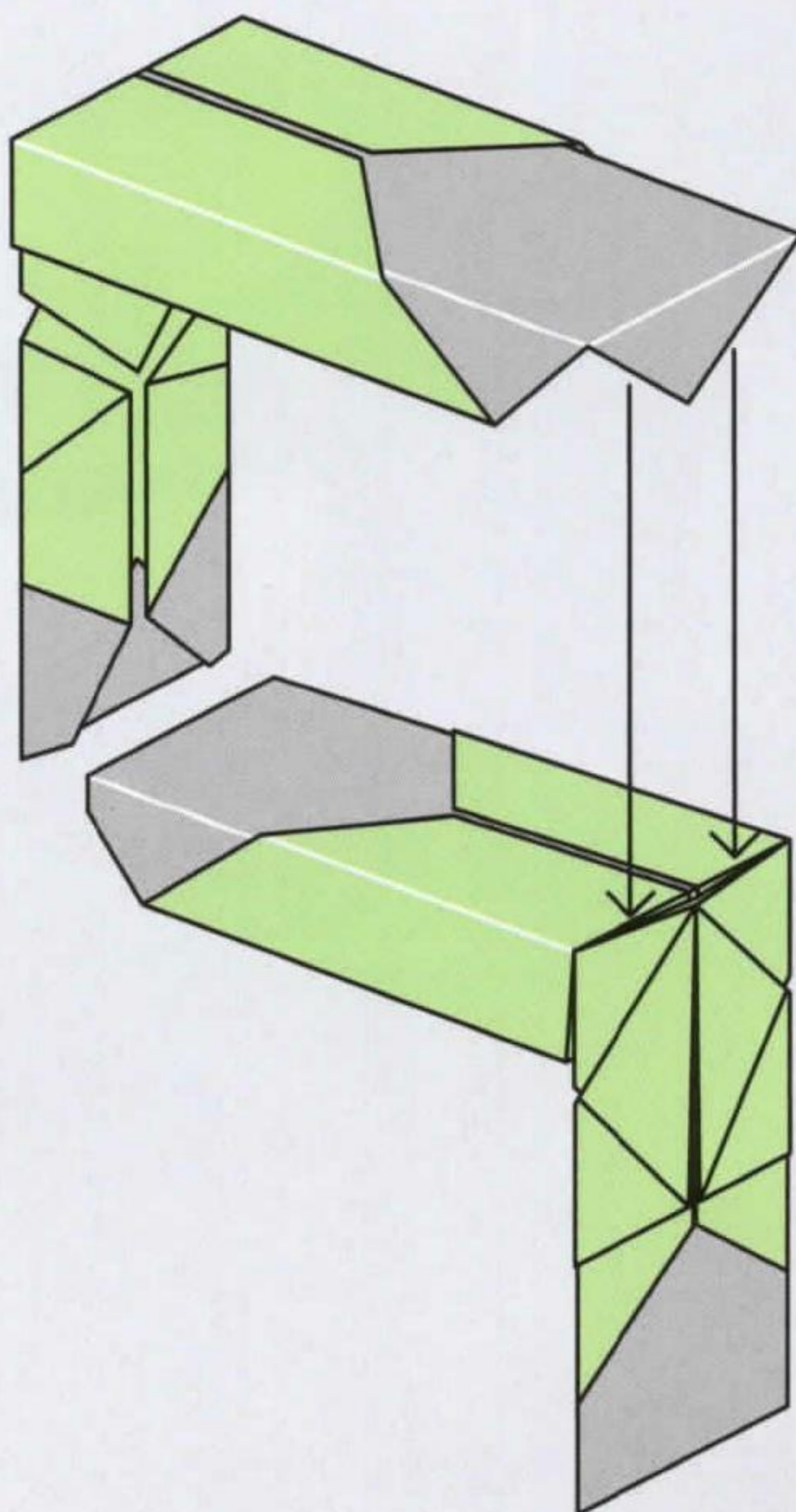

1. Insert Part 1 into Part 2 and apply glue to hold

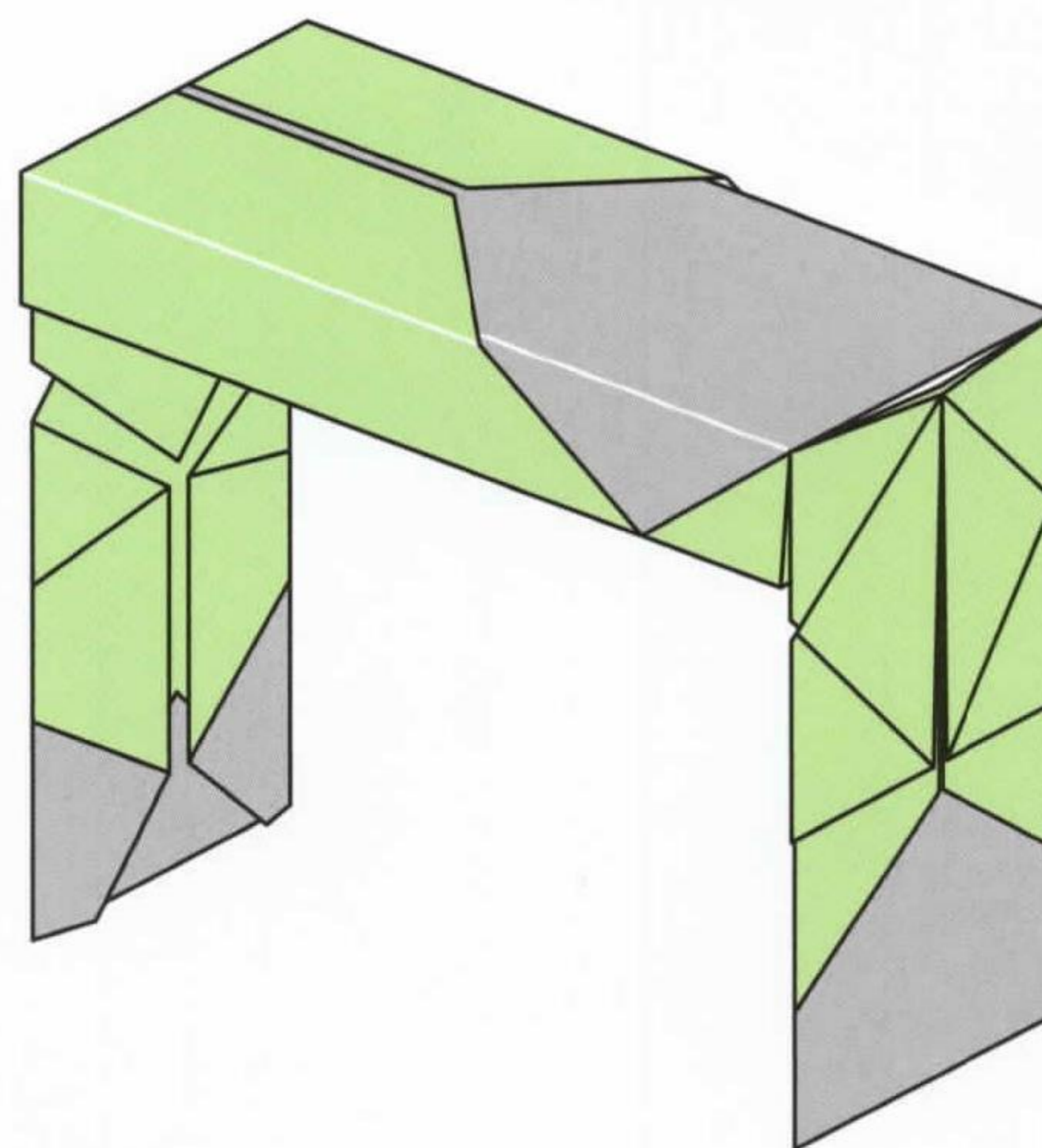

2. Completed COMPUTER DESK



5

bedroom



divan bed | dresser | wardrobe

► divan bed: part 1

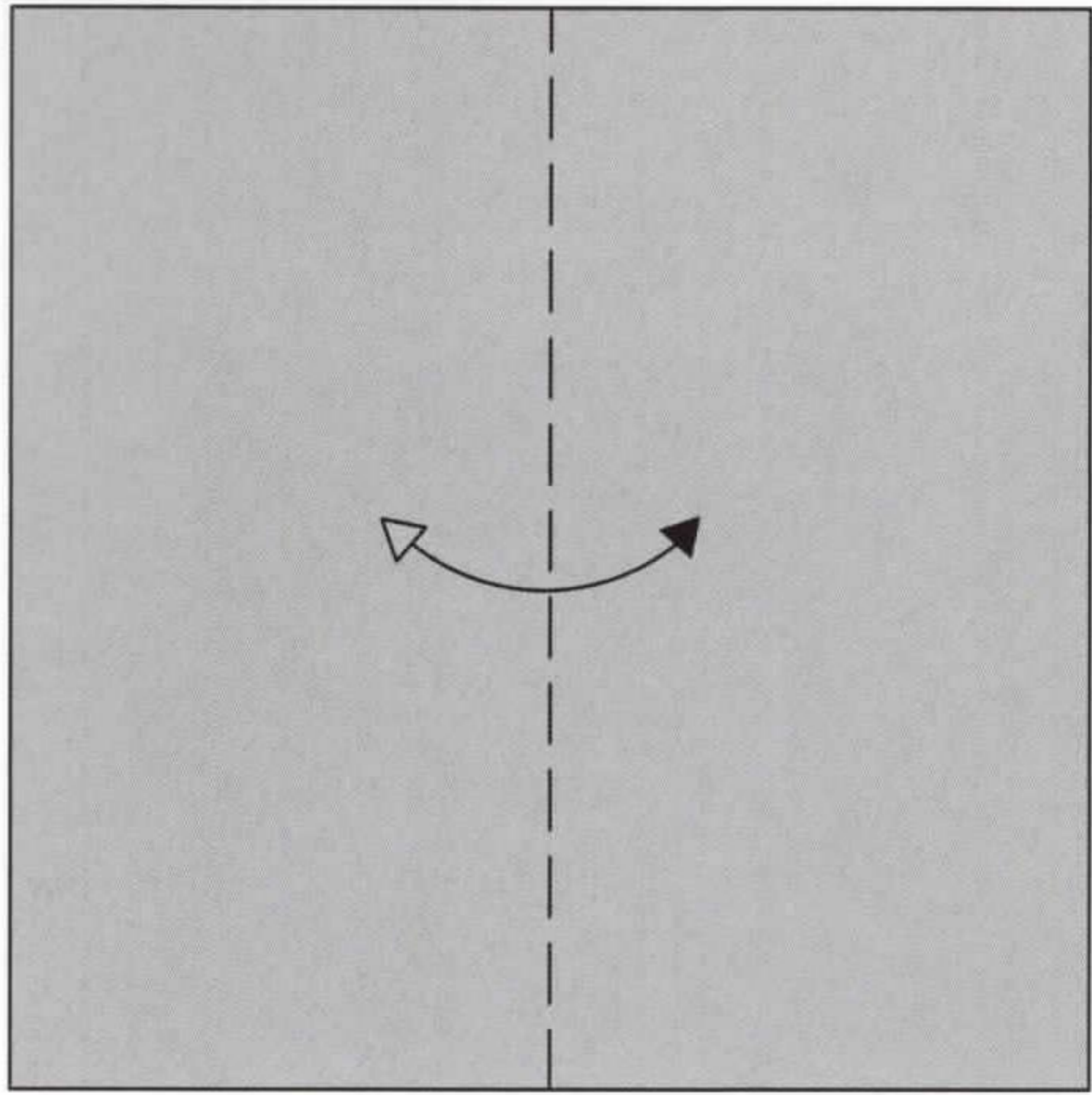

1. Valley fold and unfold

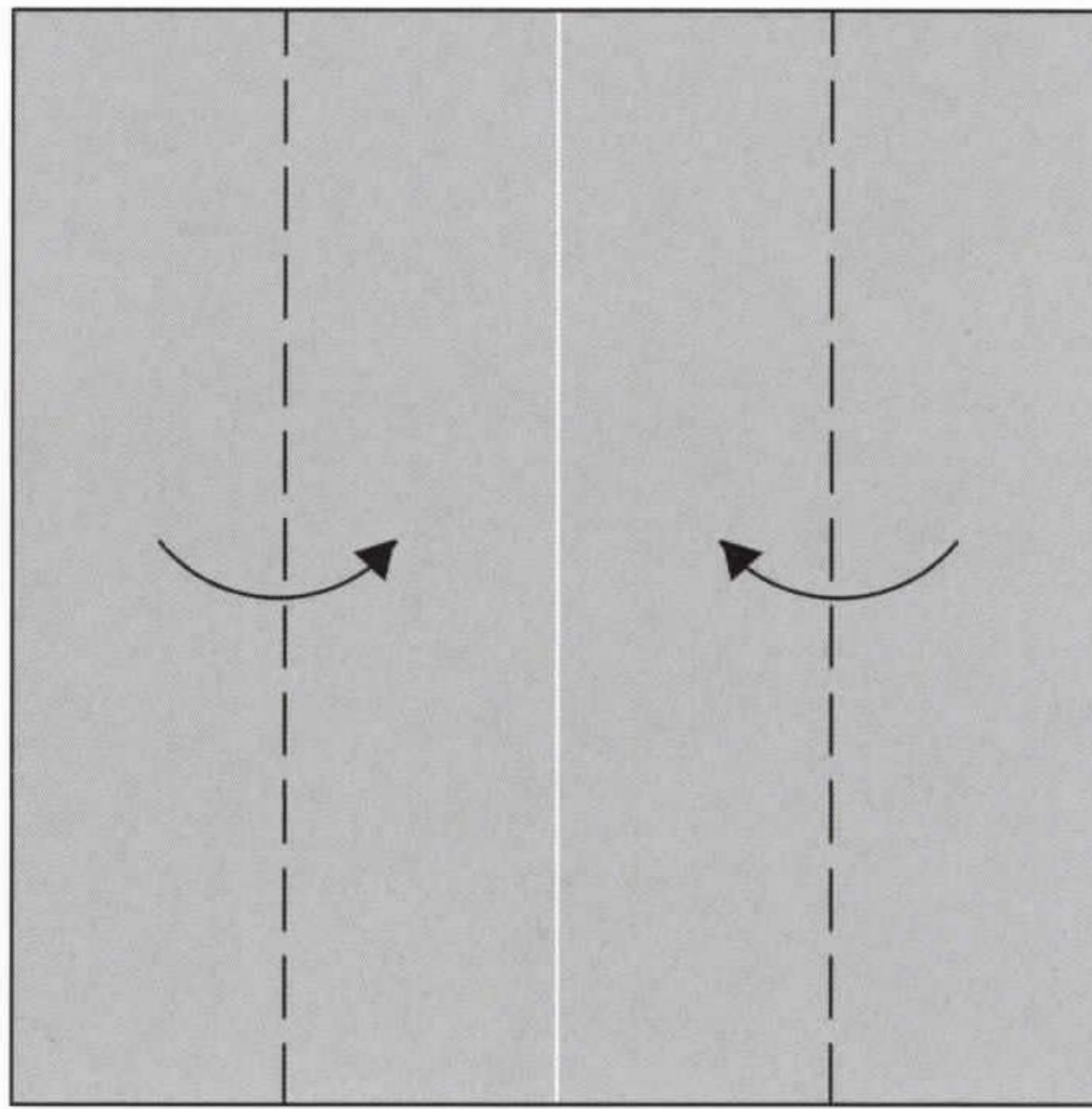

2. Valley folds

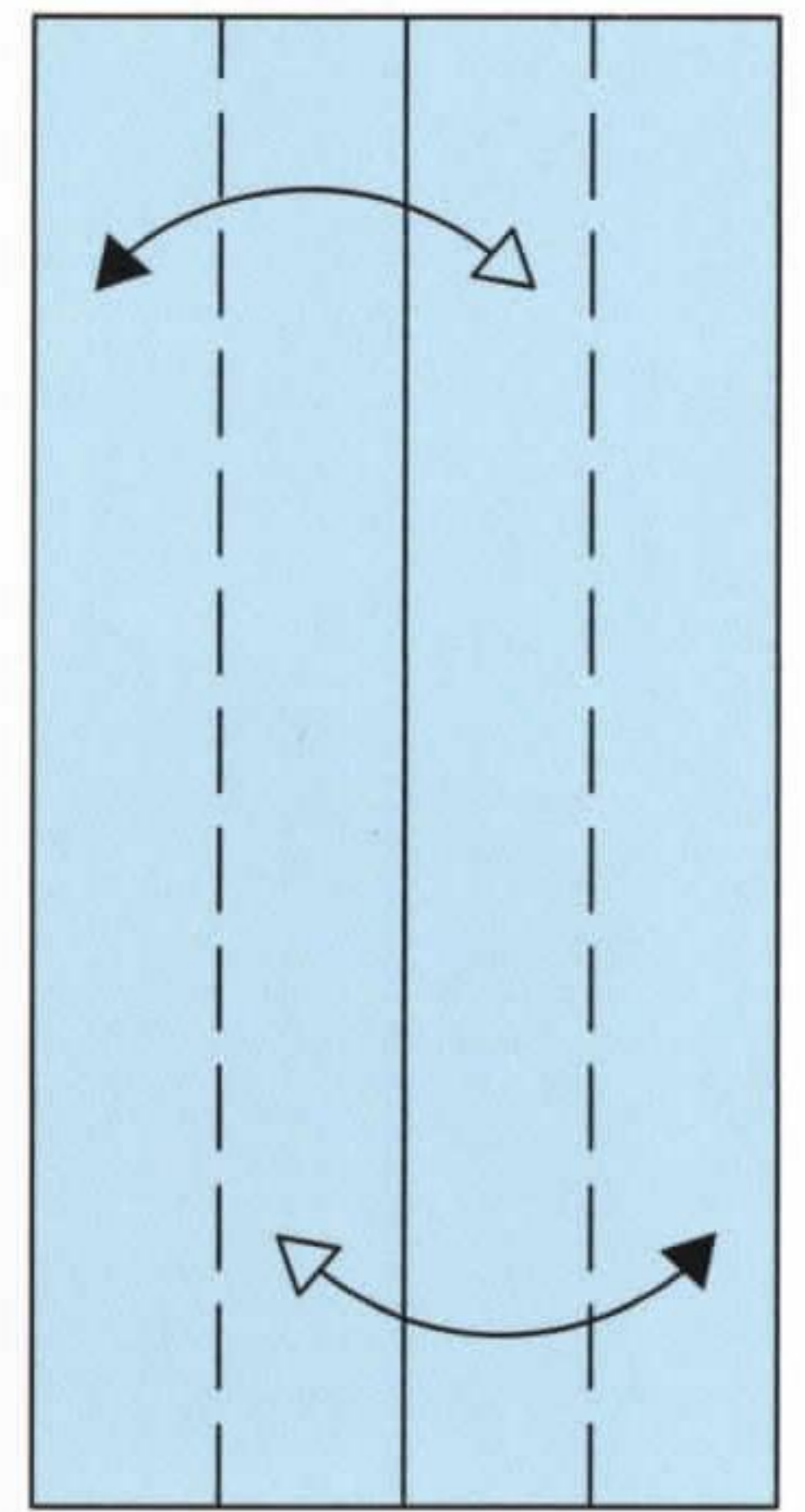

3. Valley folds and unfold

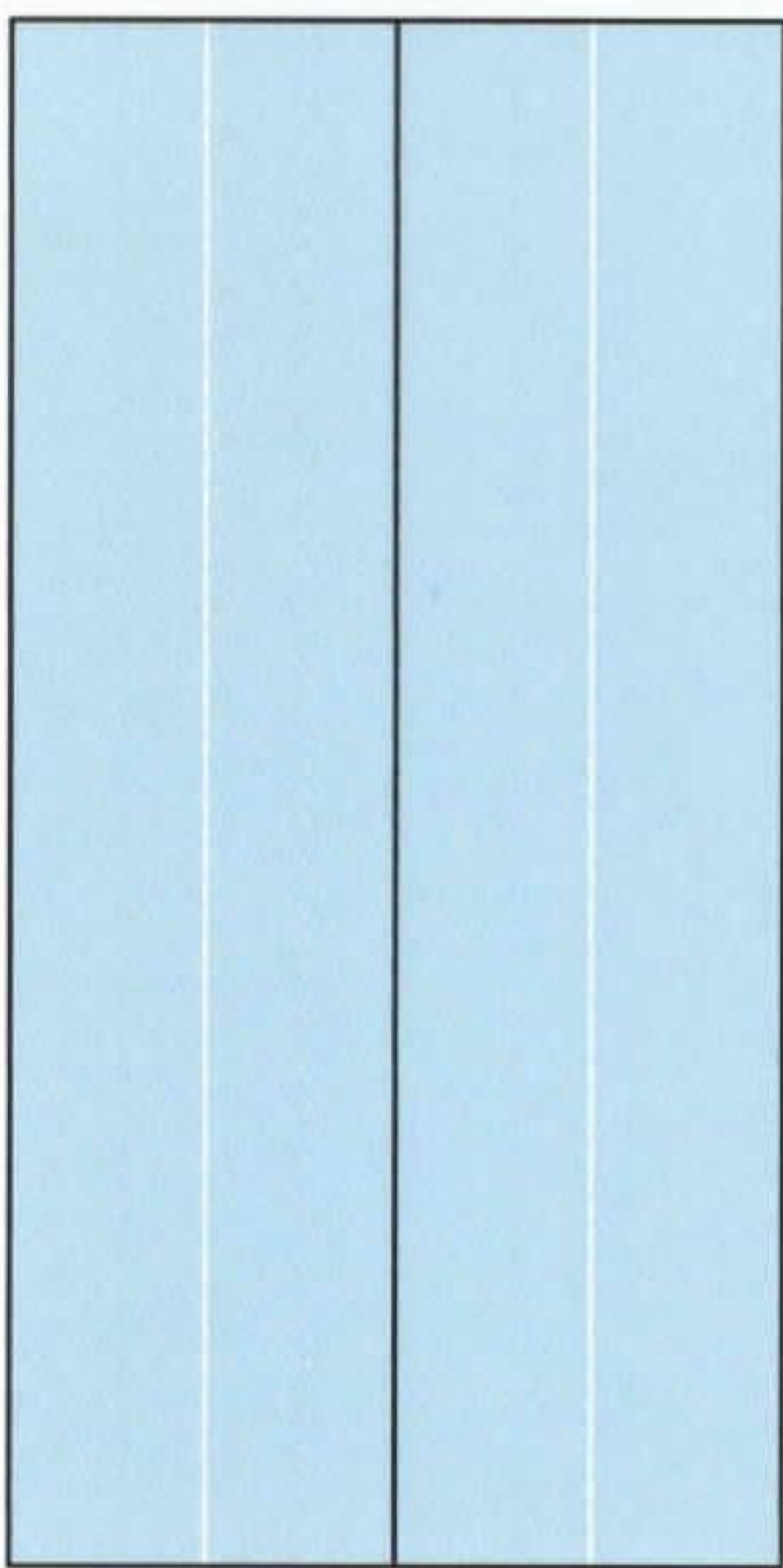

4. Scale-up

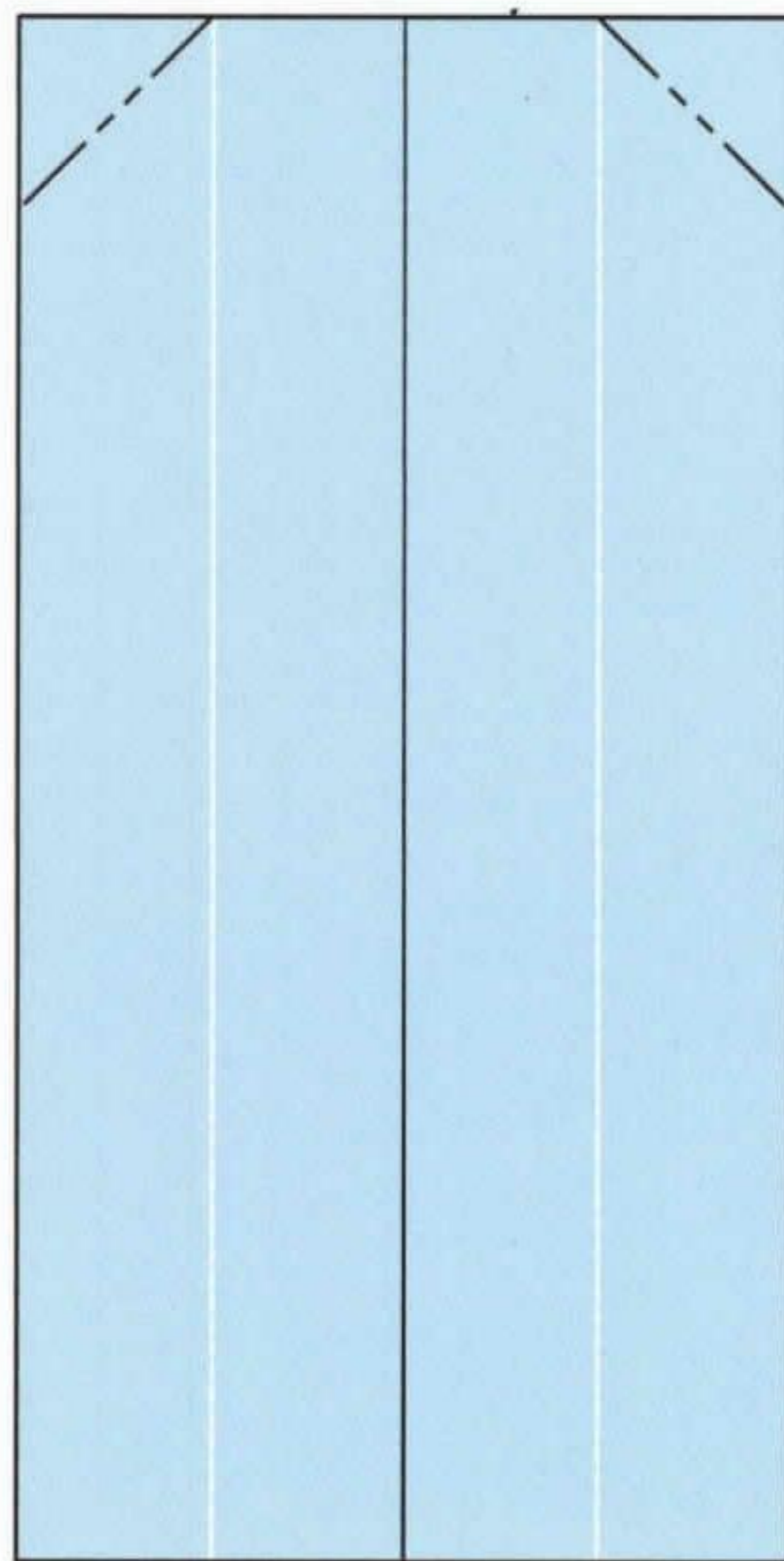

5. Inside reverse folds

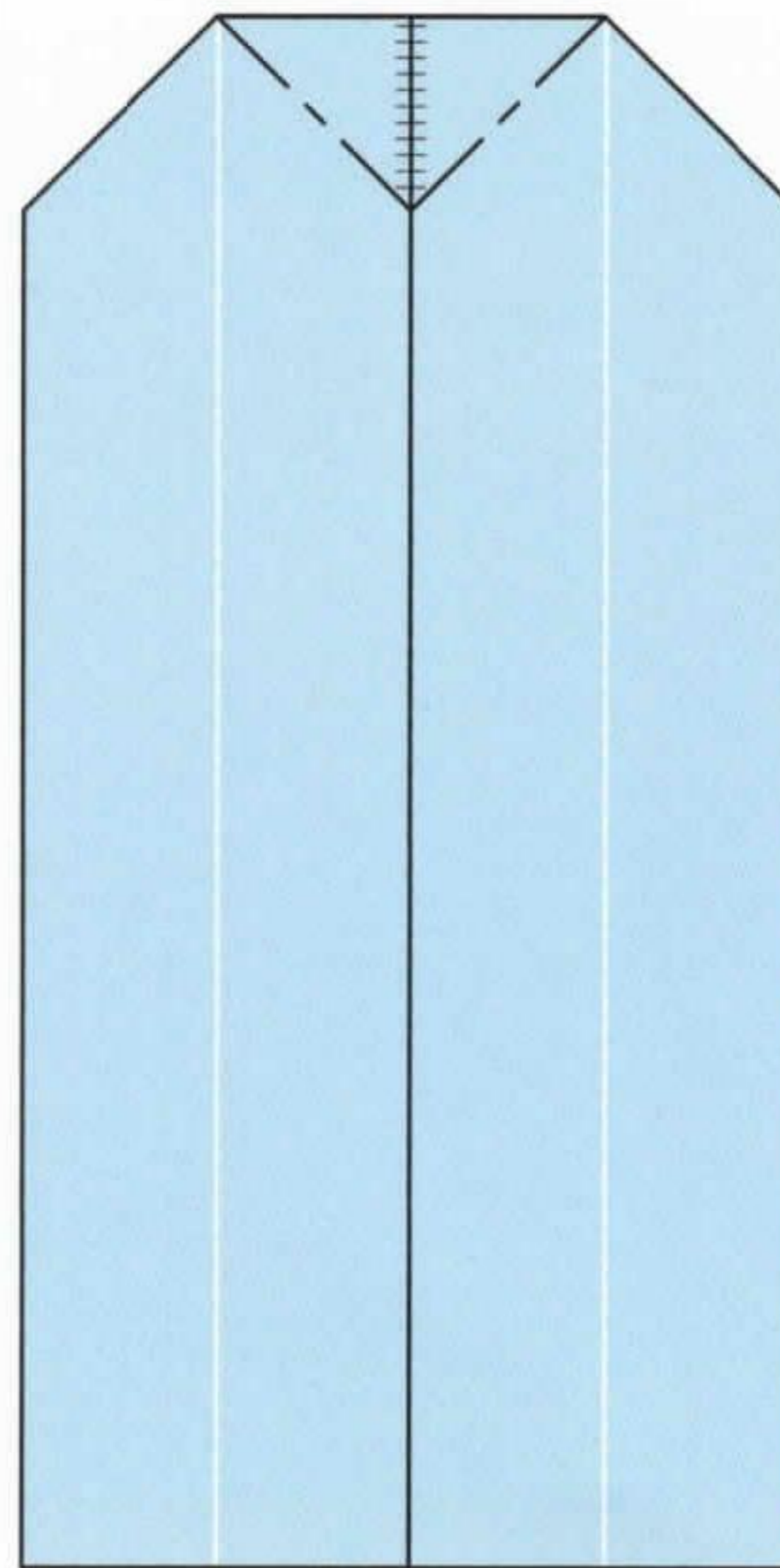

6. Cut and mountain folds

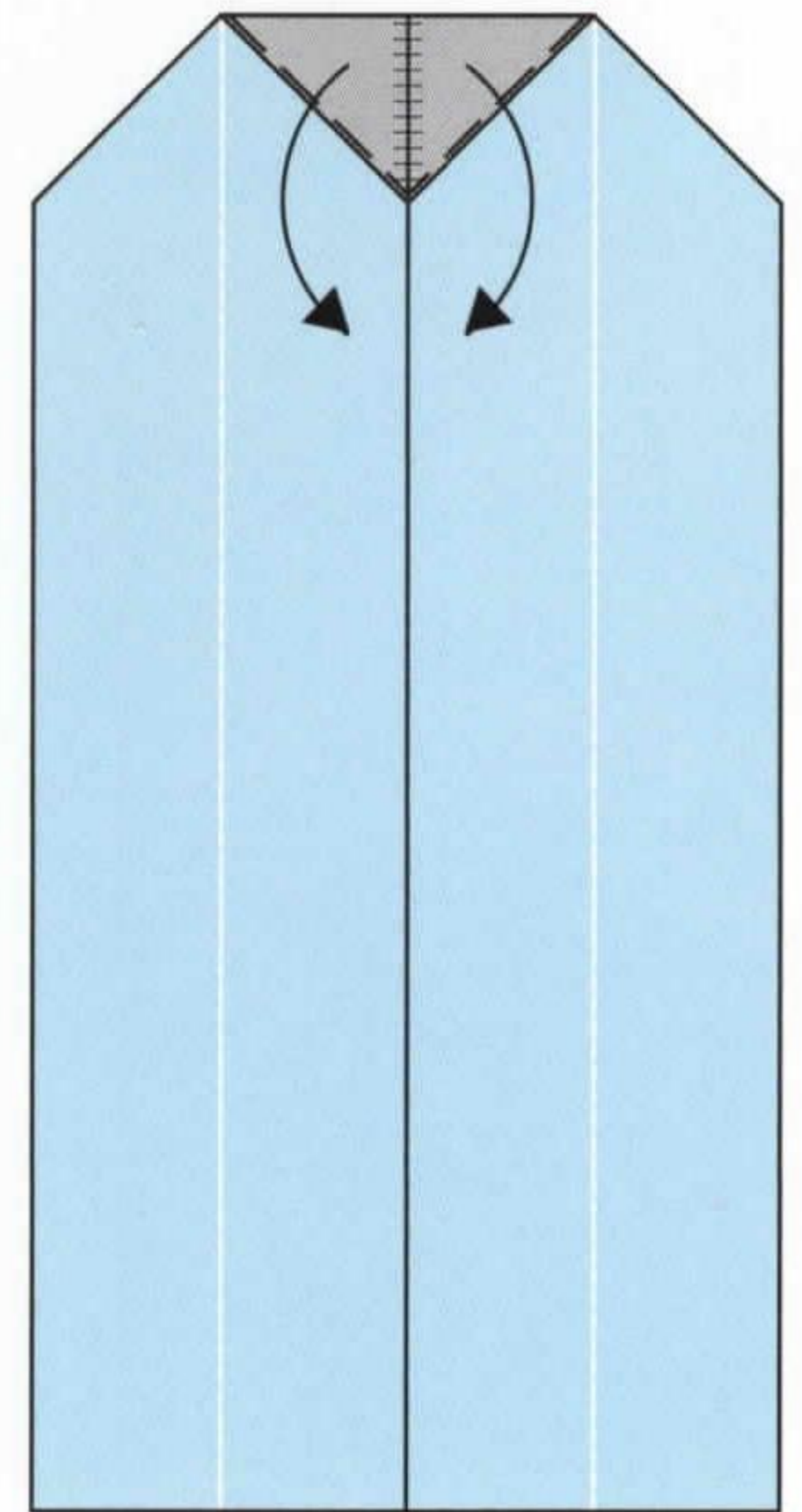

7. Valley folds

divan bed: part 1

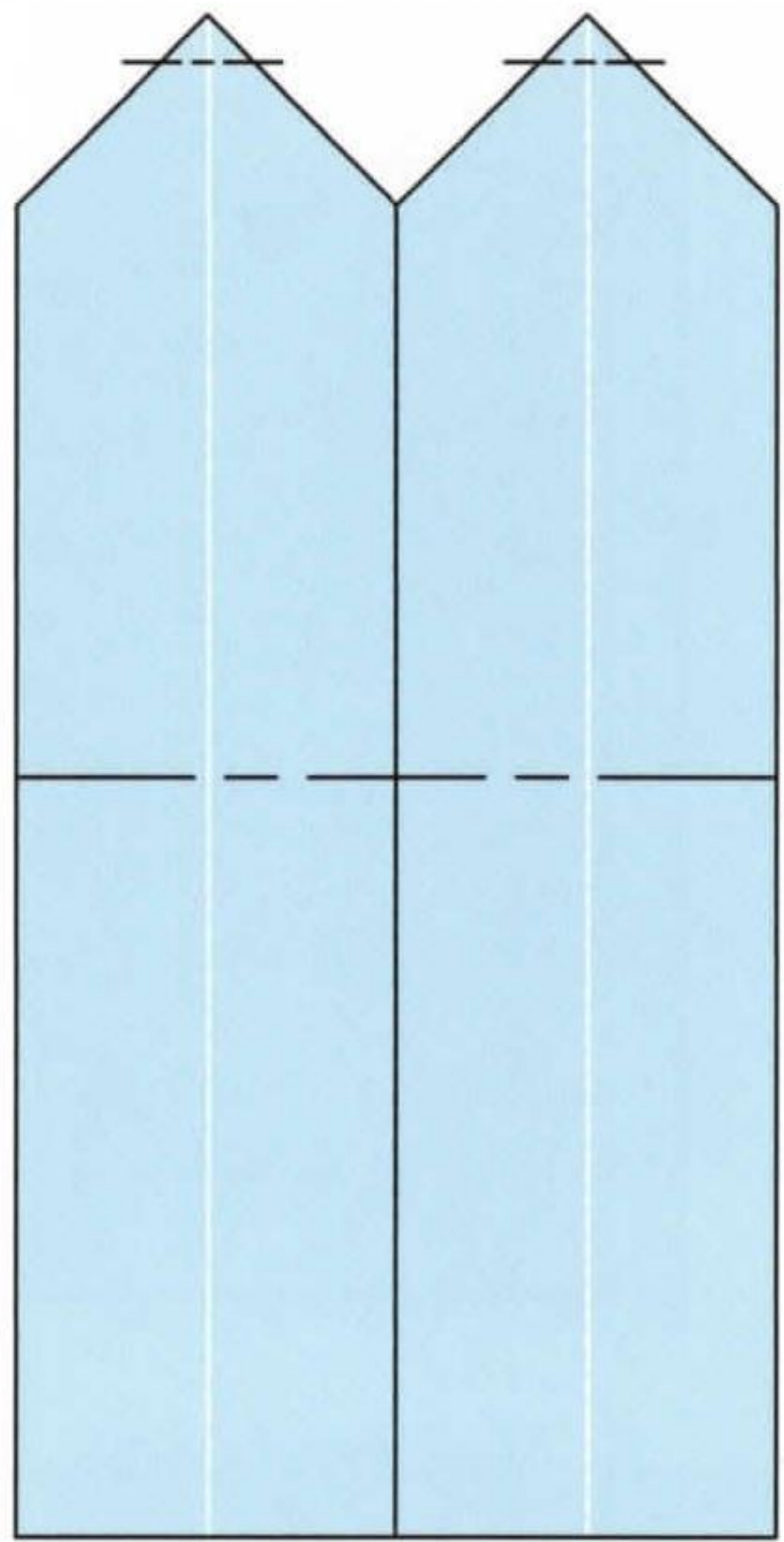

8. Mountain folds

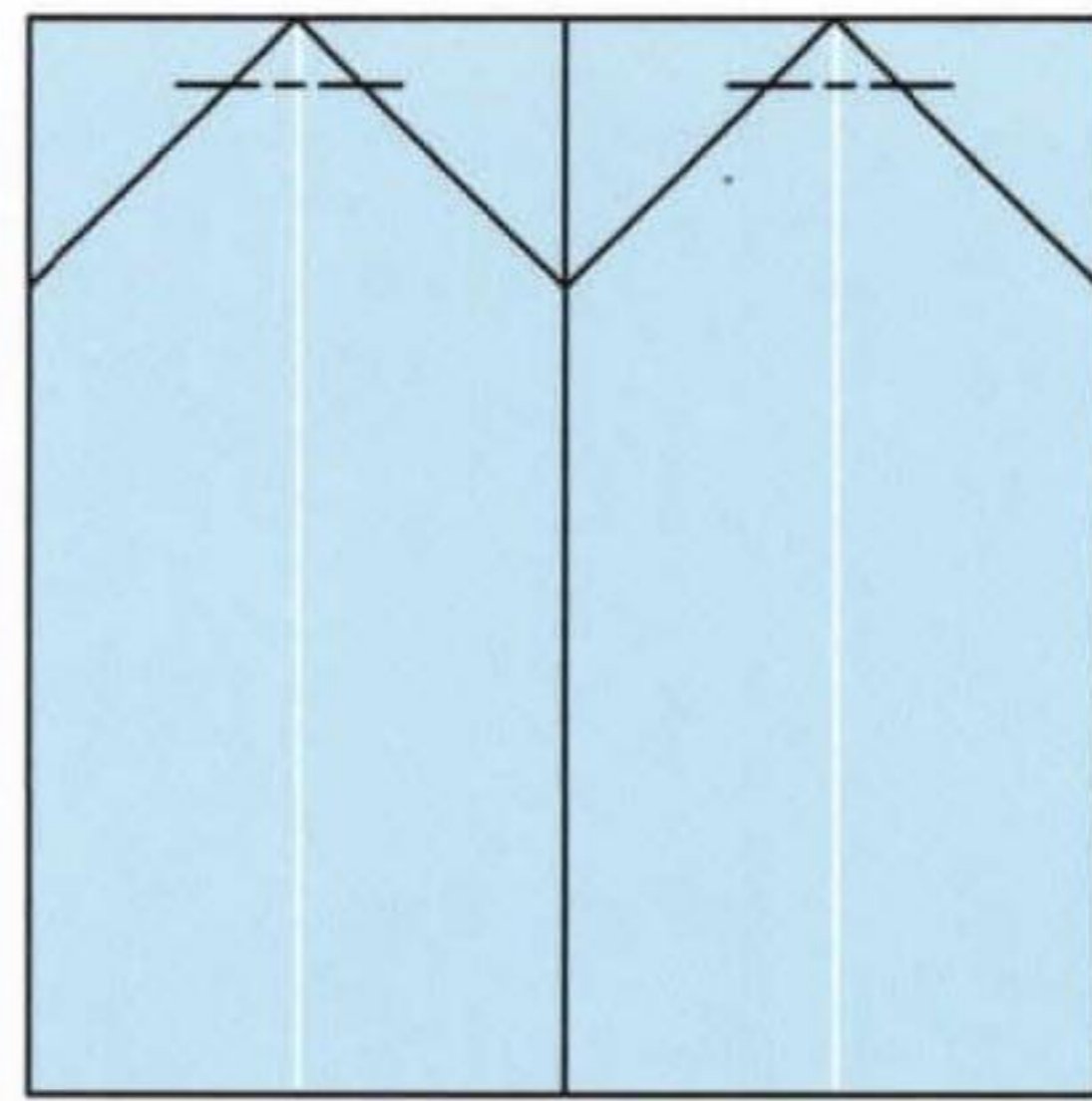

9. Mountain folds

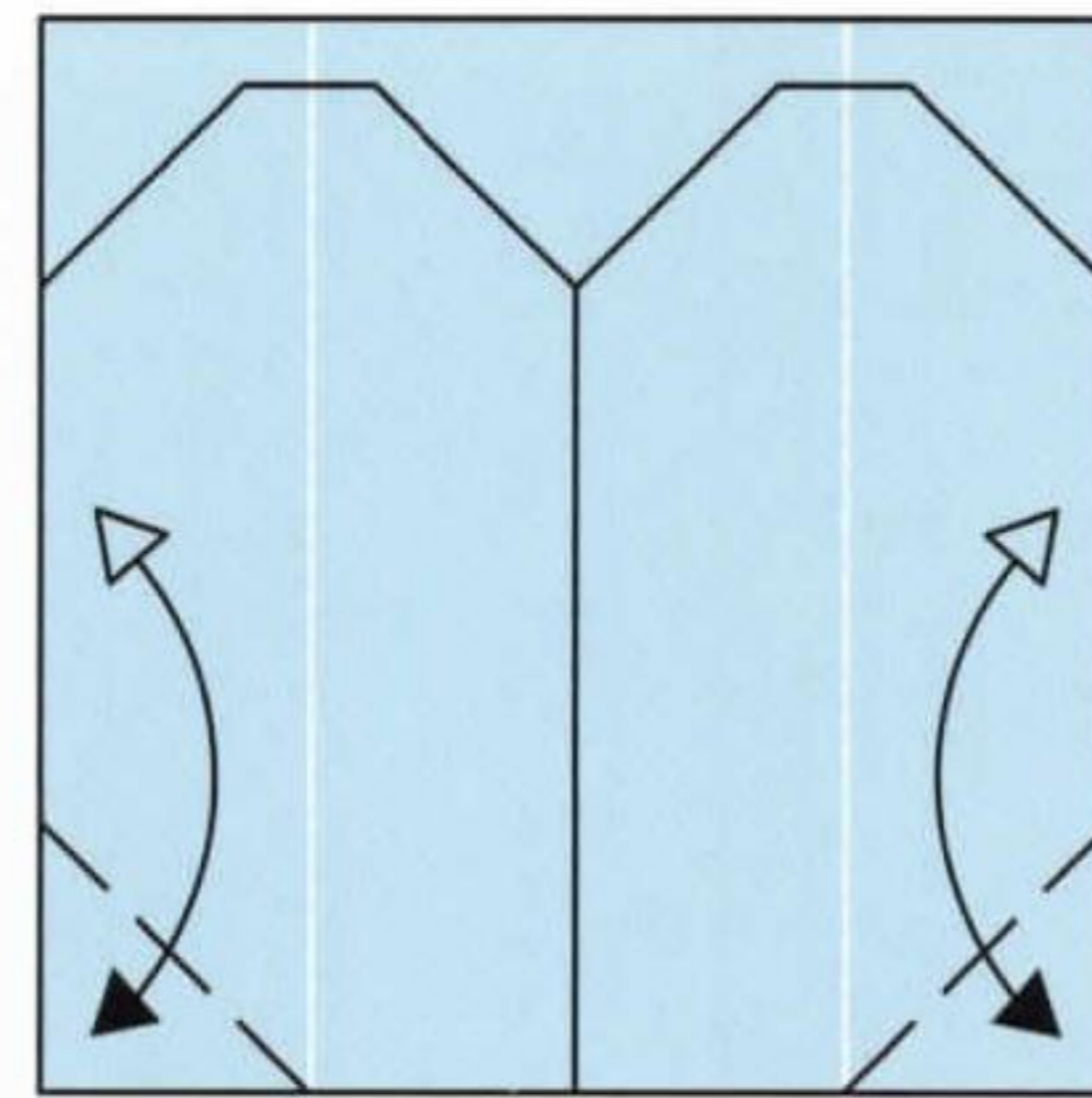

10. Fold and unfold

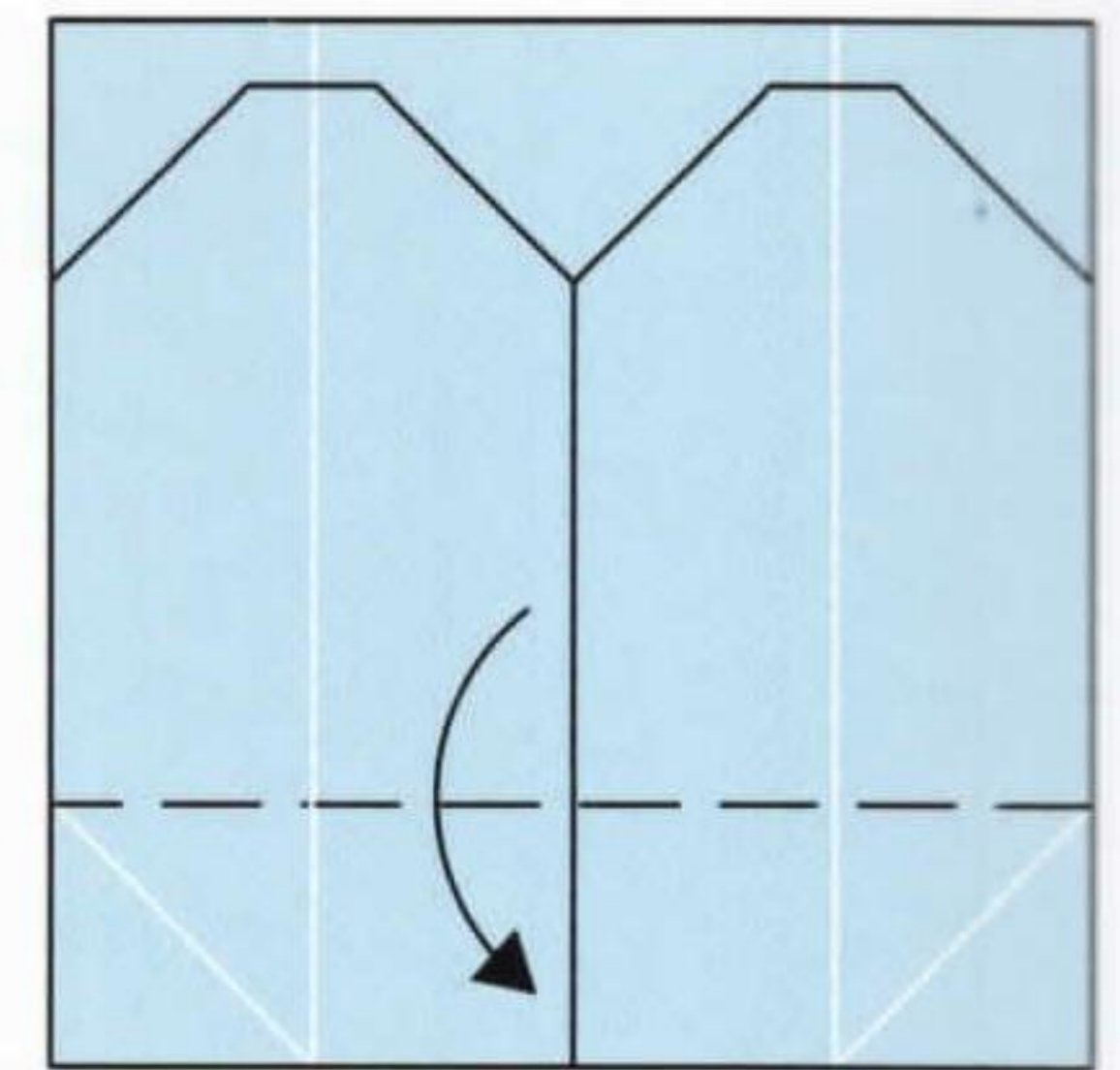

11. Valley fold

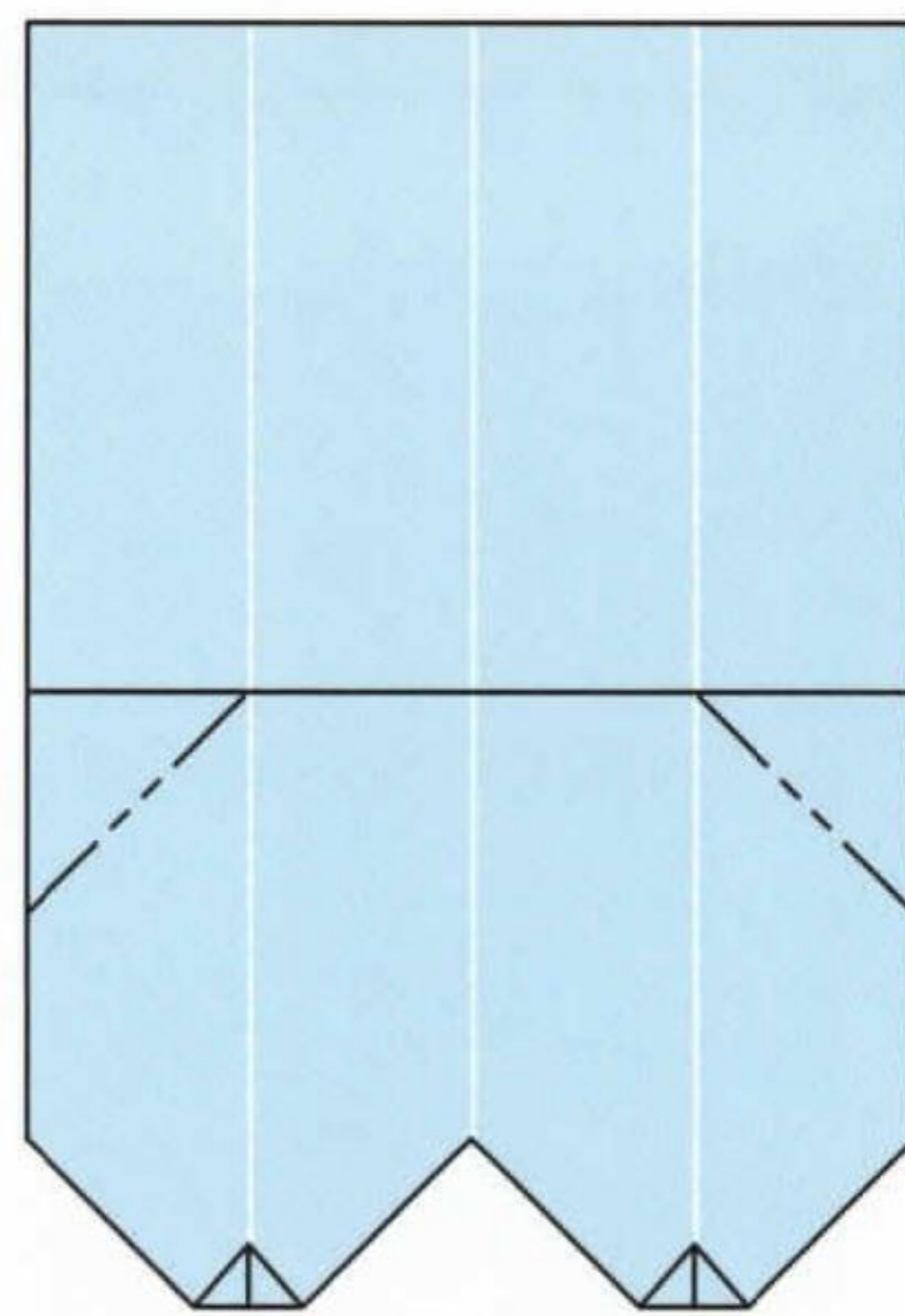

12. Inside reverse folds

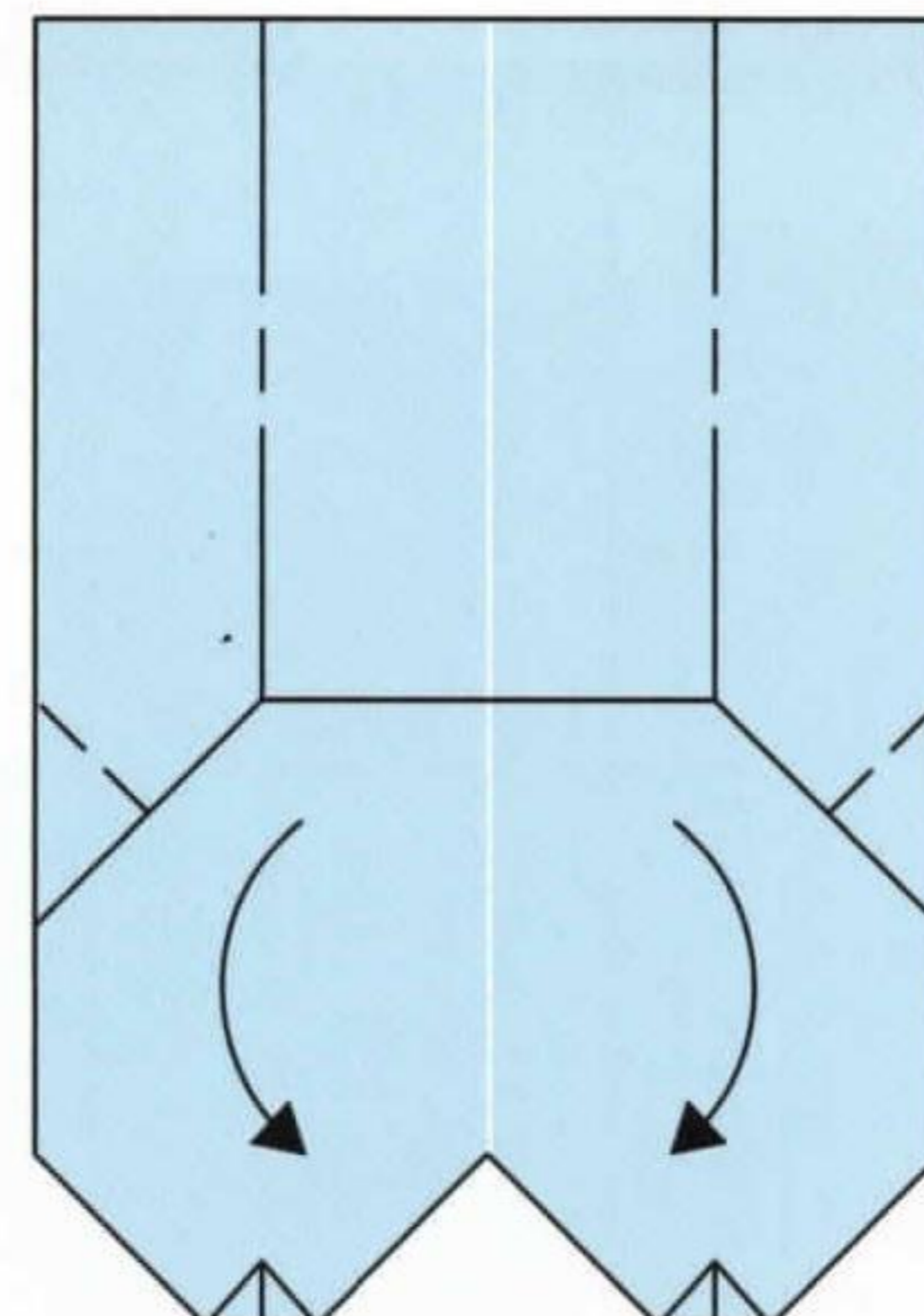

13. Crimp folds

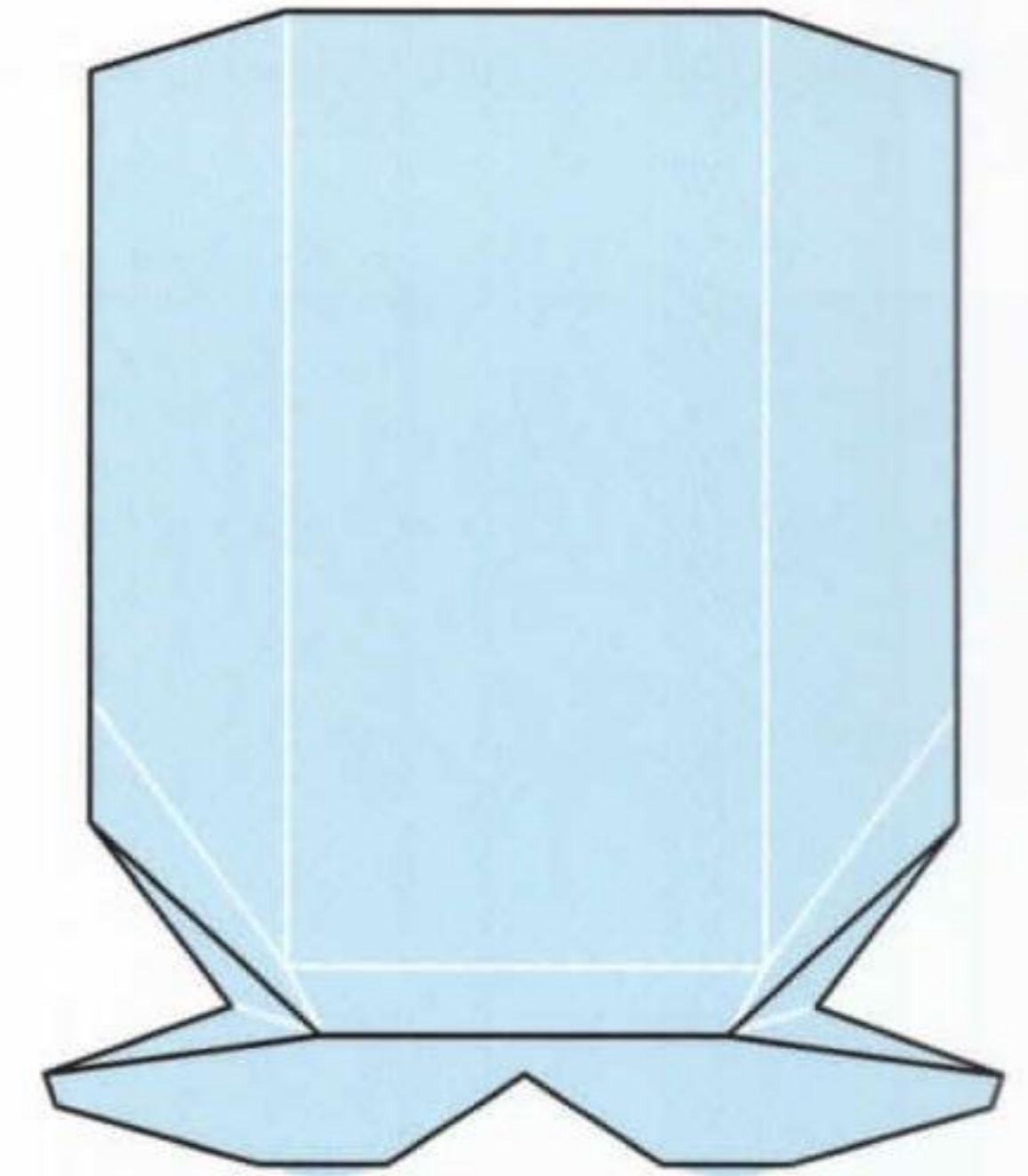

14. Before complete

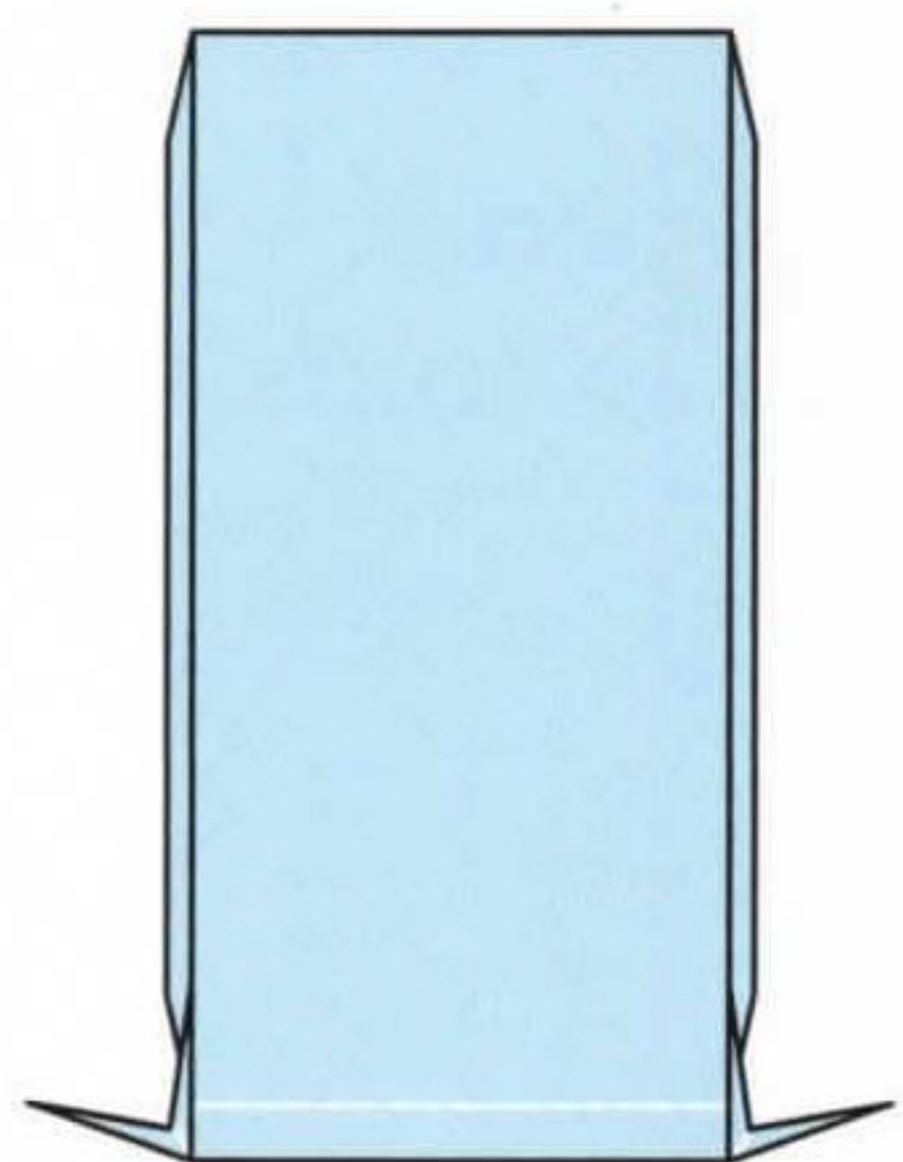

15. Rotate

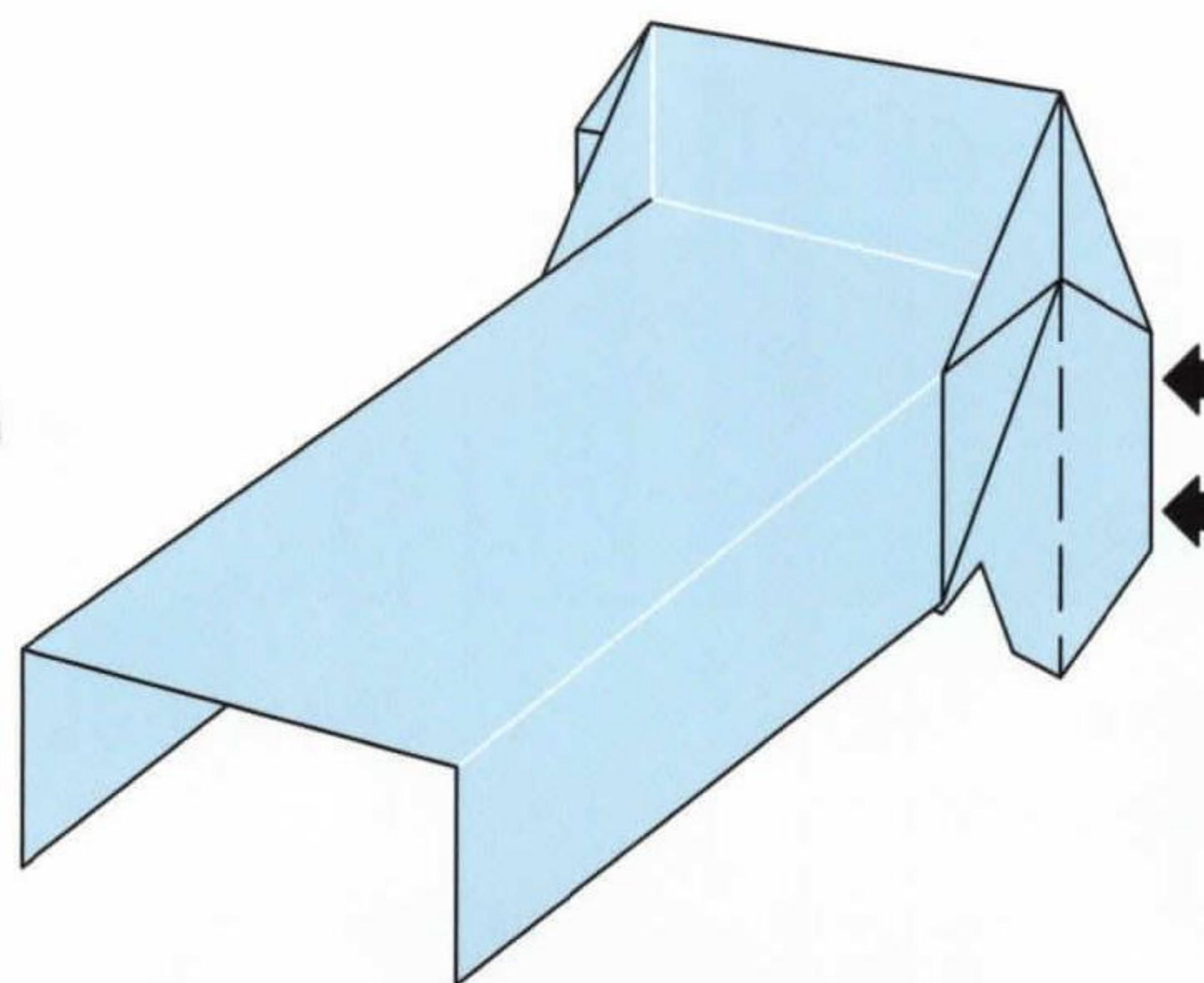

16. Valley fold both sides and add glue

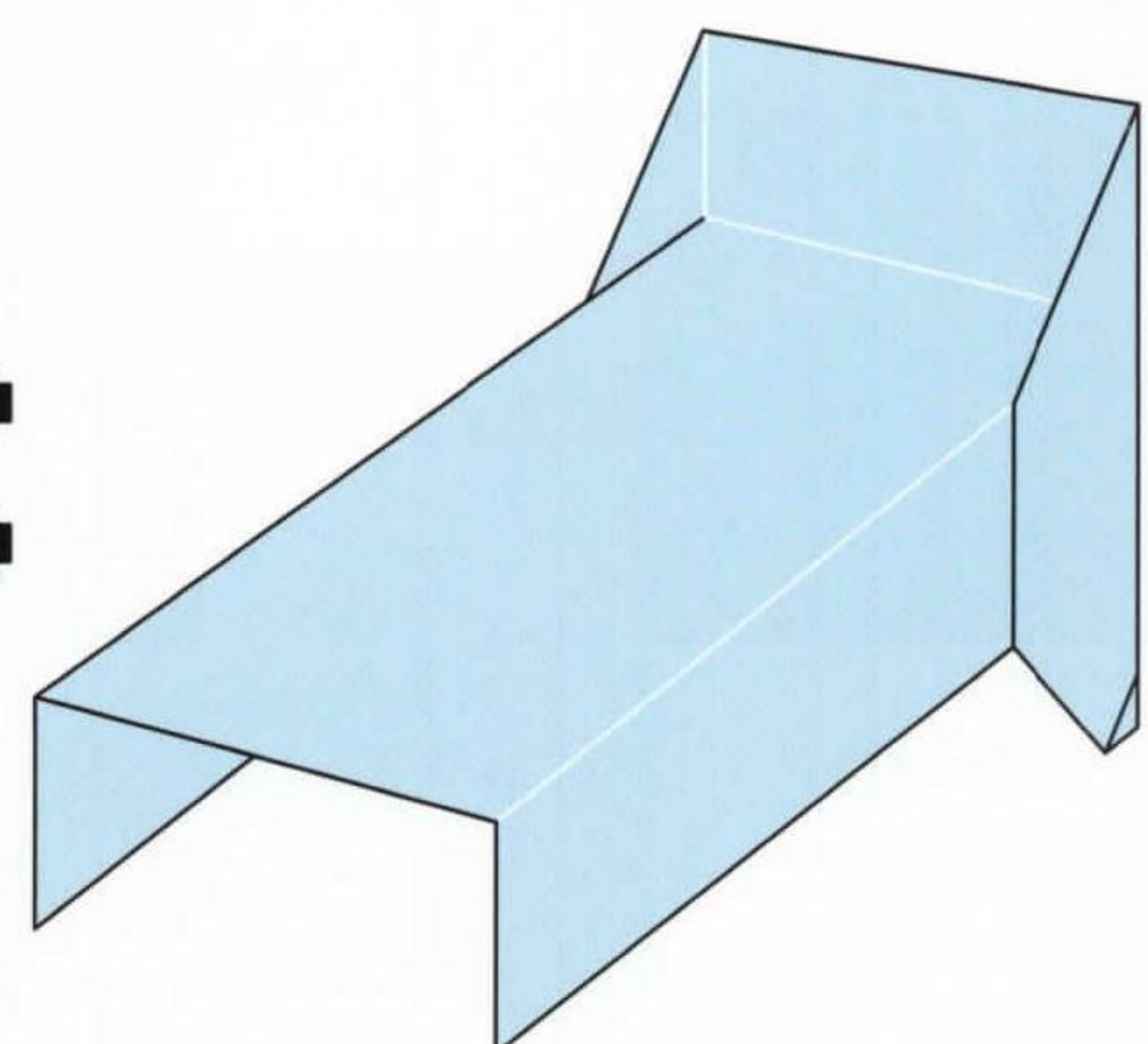

17. Completed PART 1

divan bed: part 2

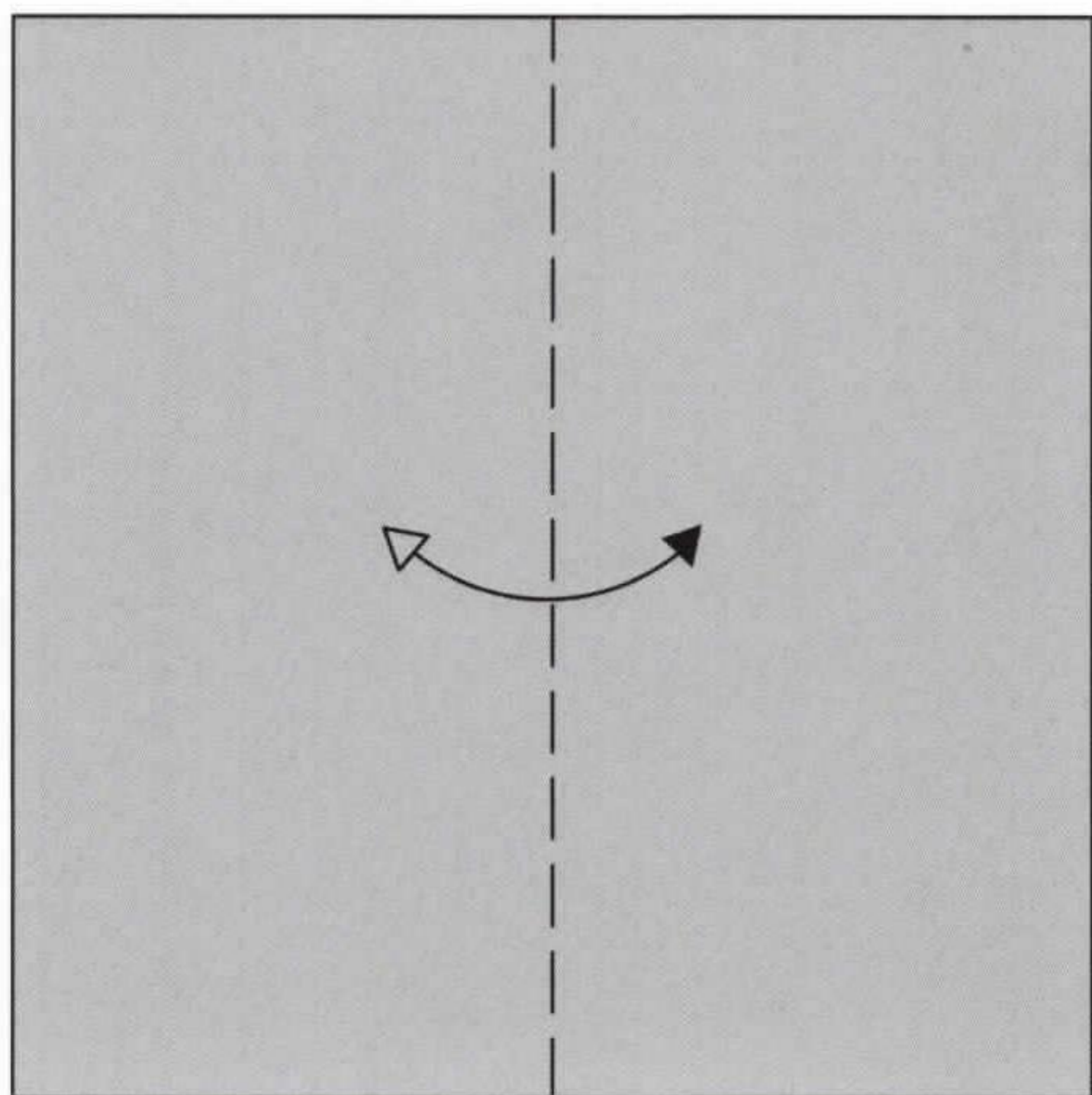

1. Valley fold and unfold

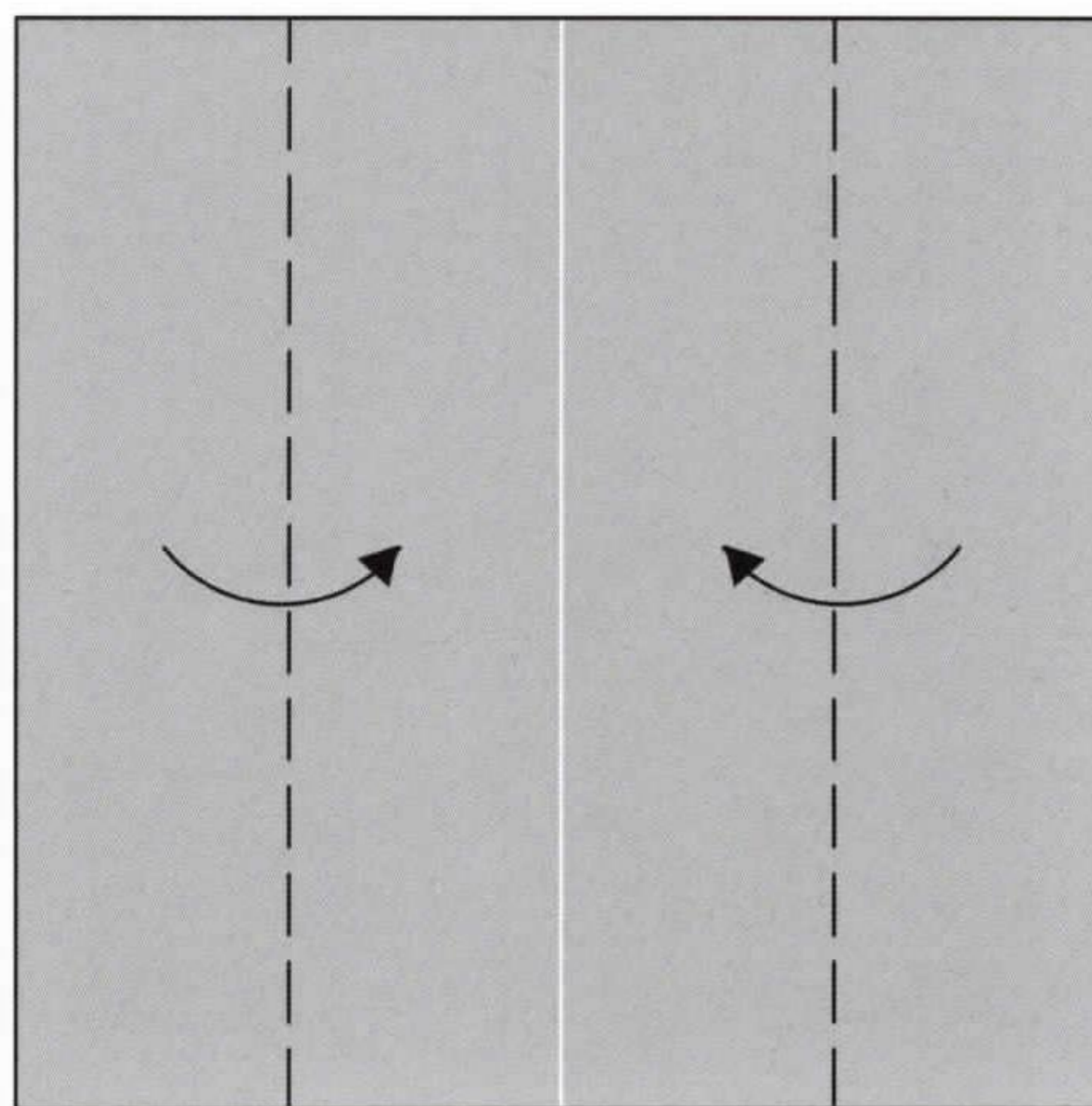

2. Valley folds

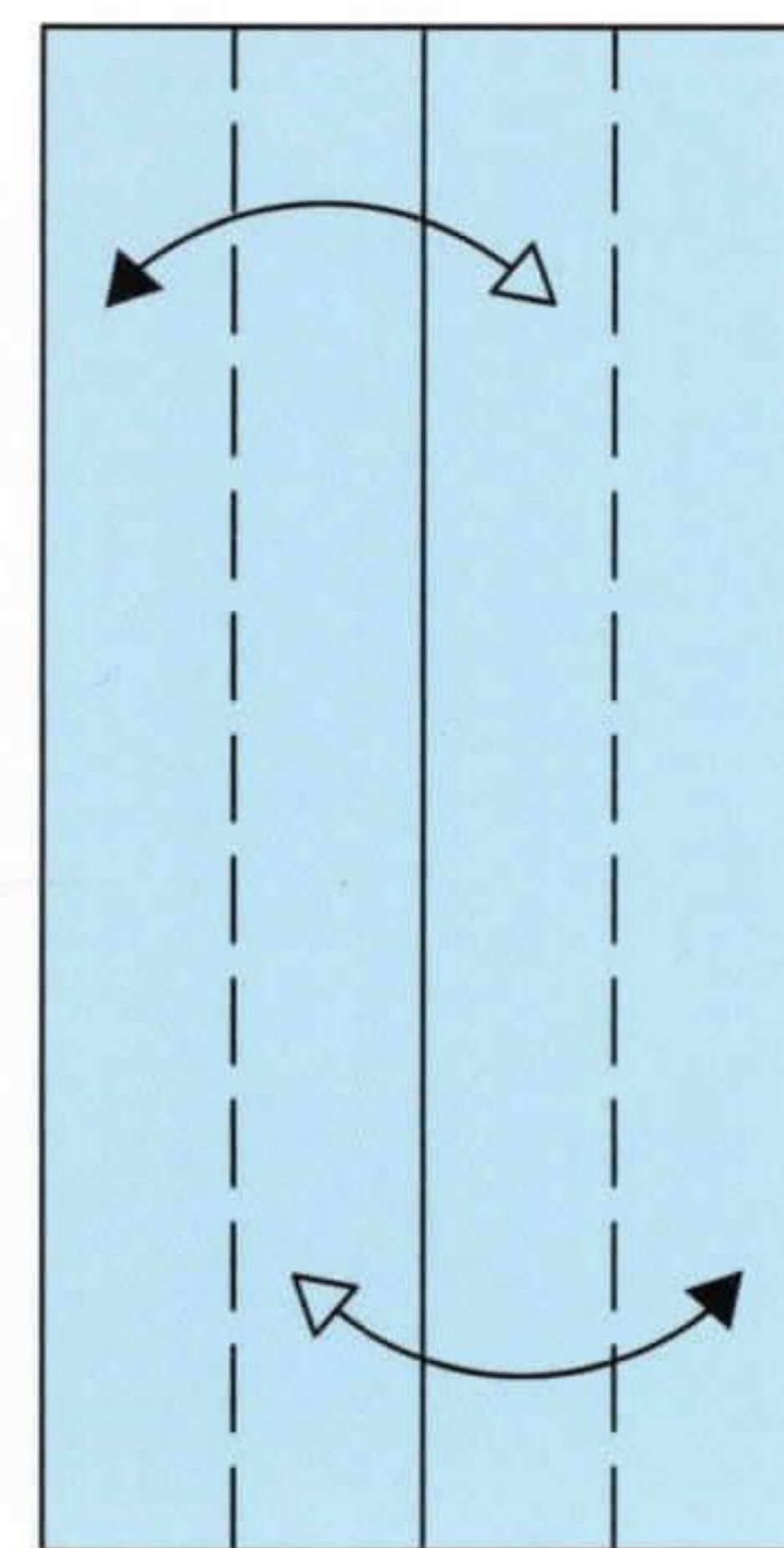

3. Valley folds and unfold

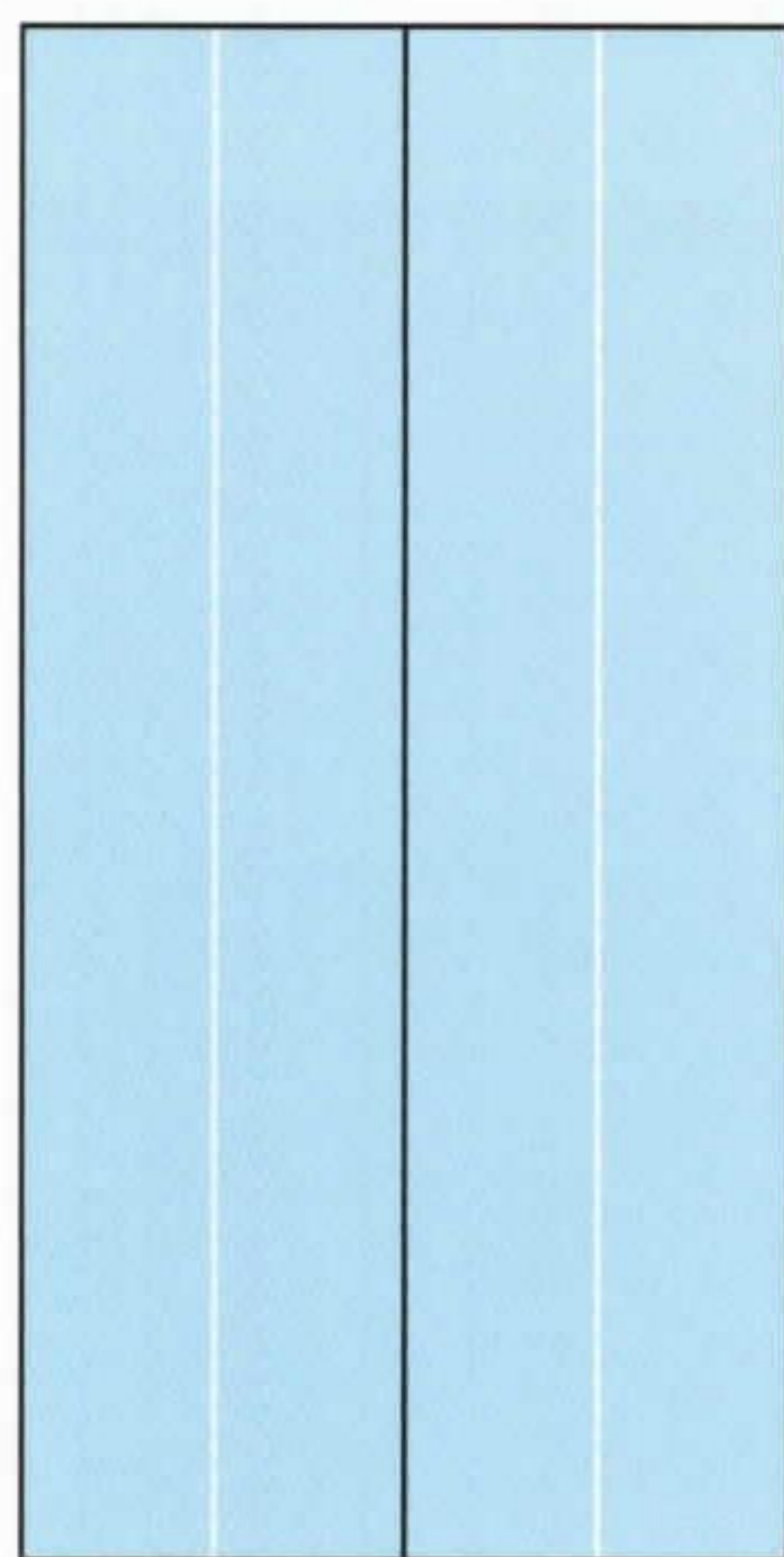

4. Scale-up

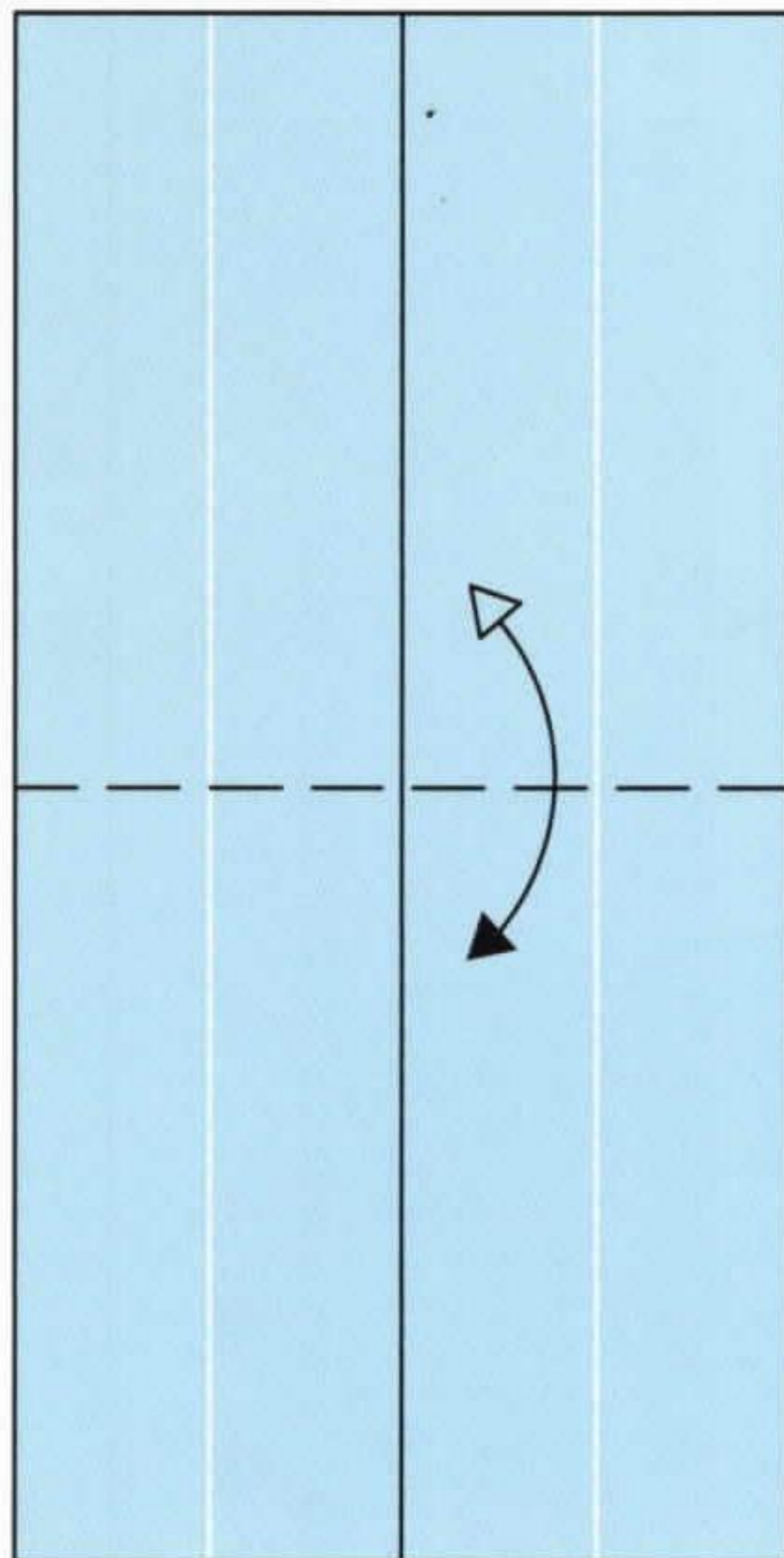

5. Valley fold and unfold

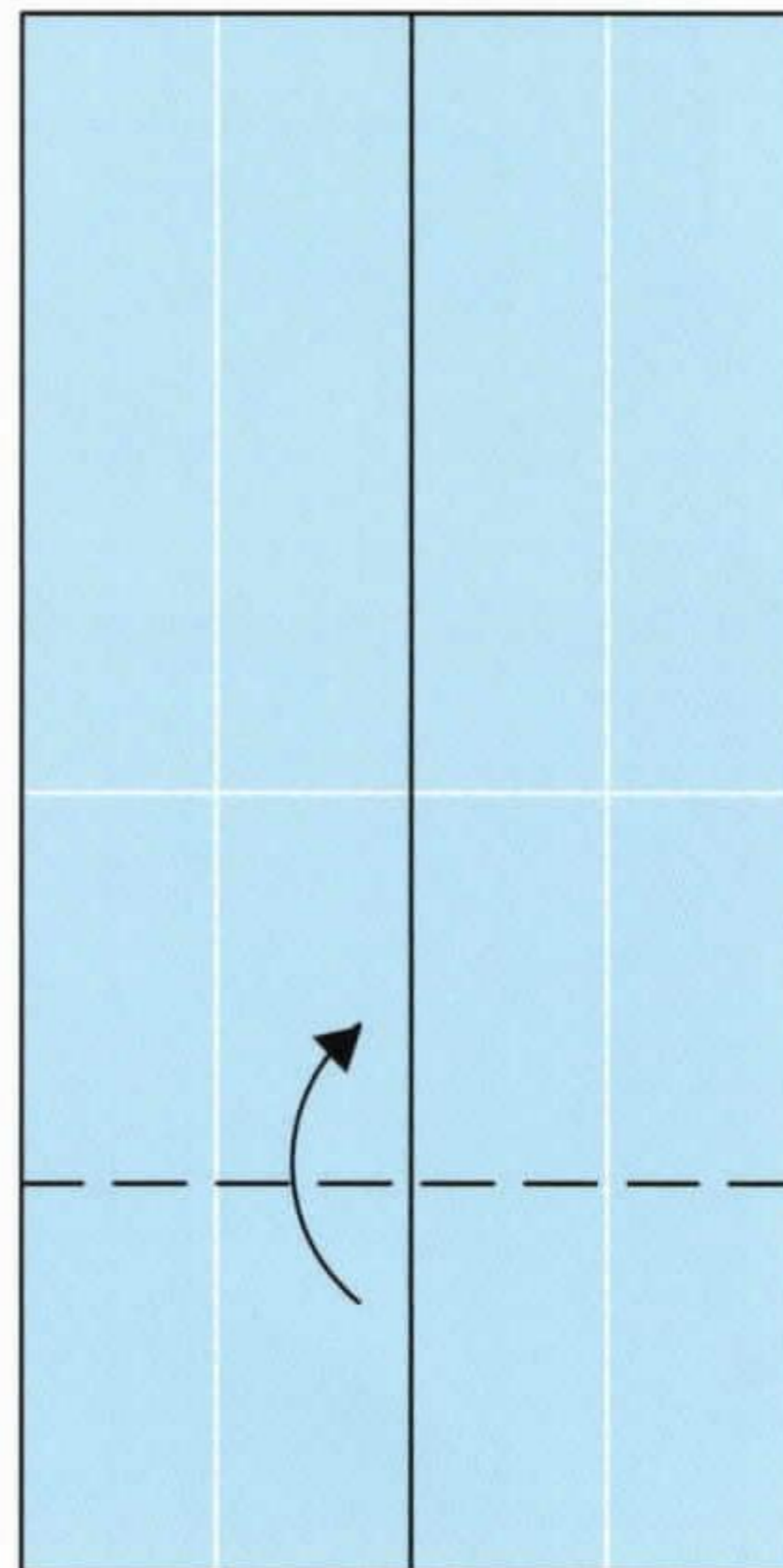

6. Valley fold

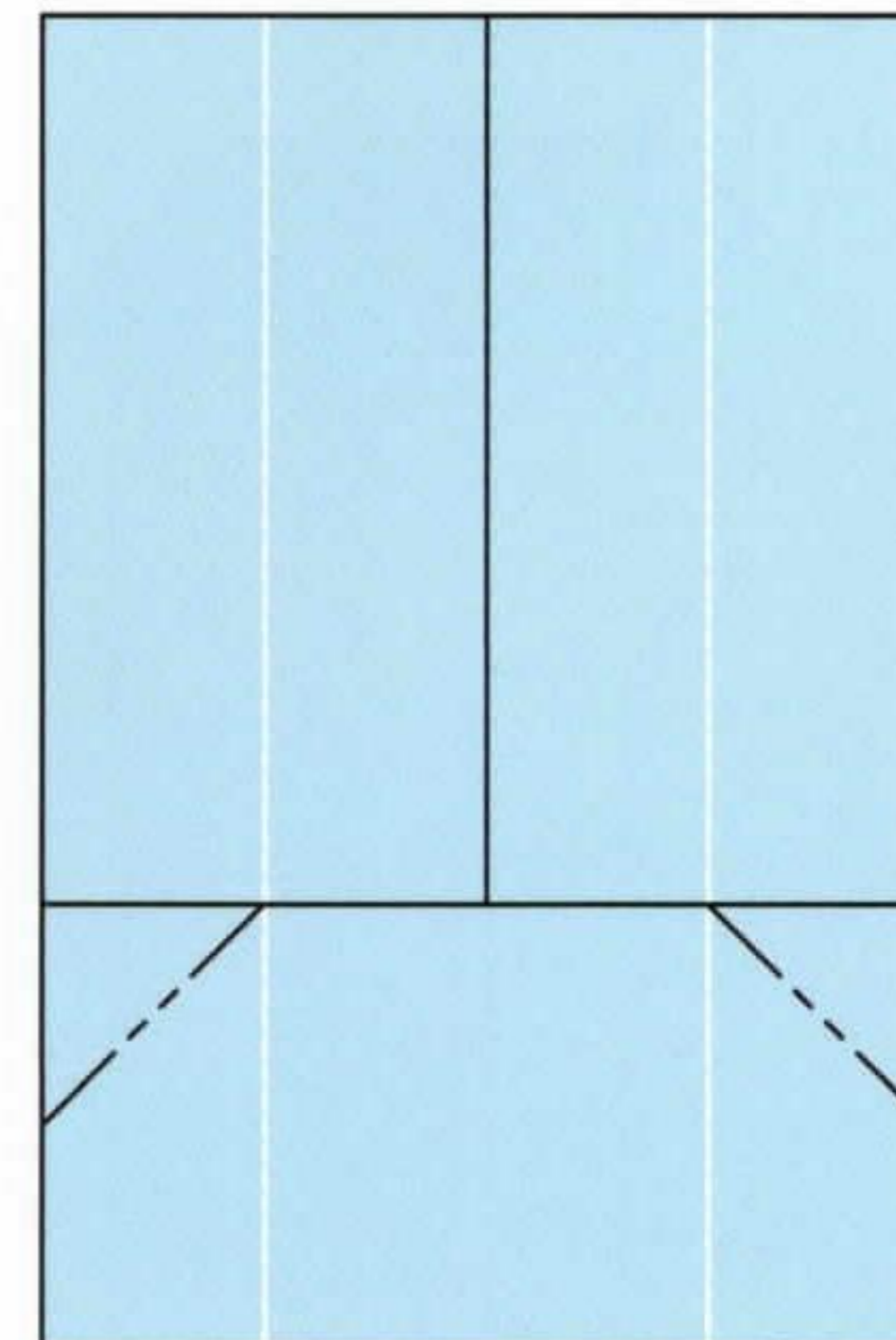

7. Inside reverse folds

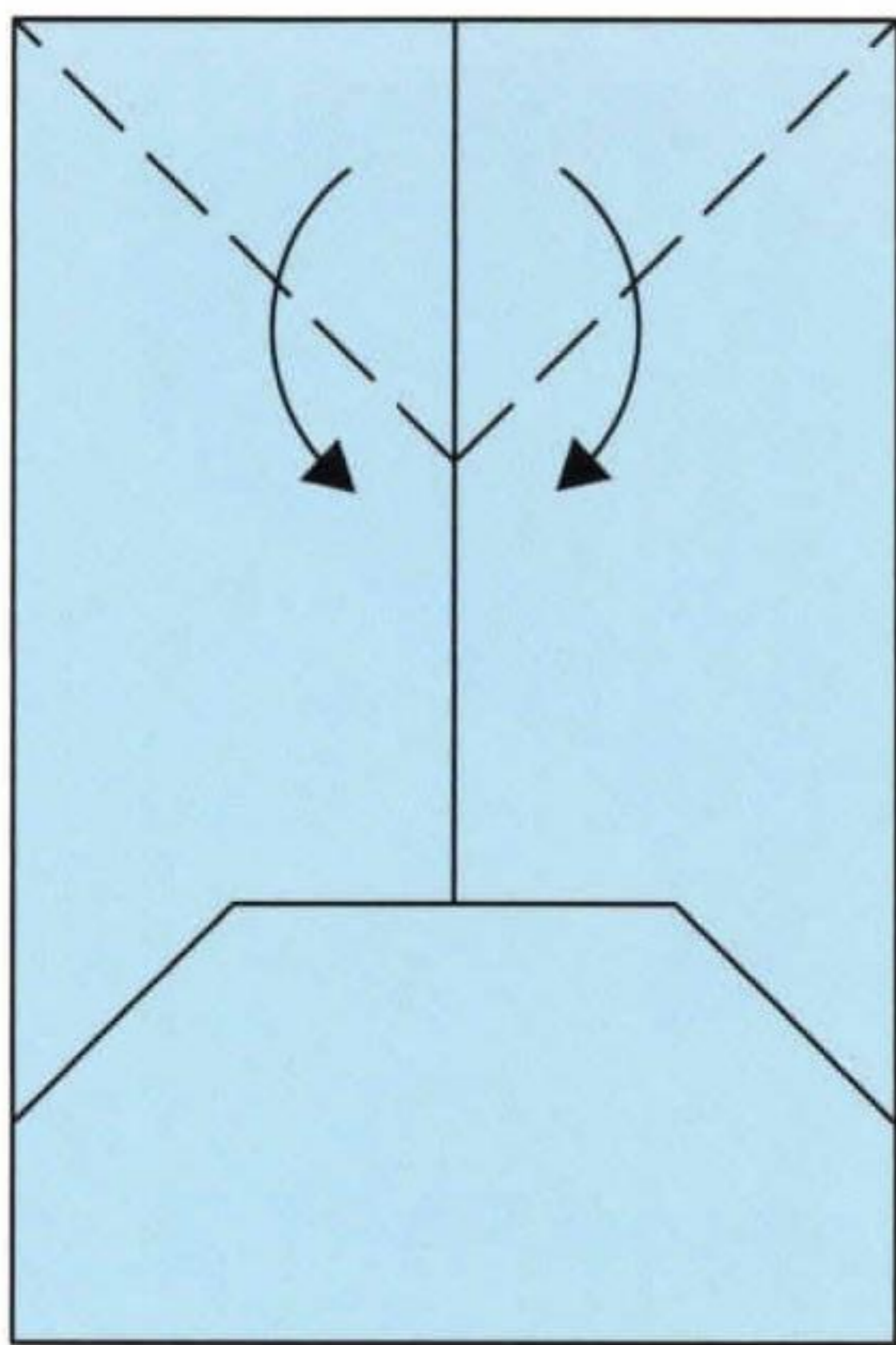

8. Valley folds

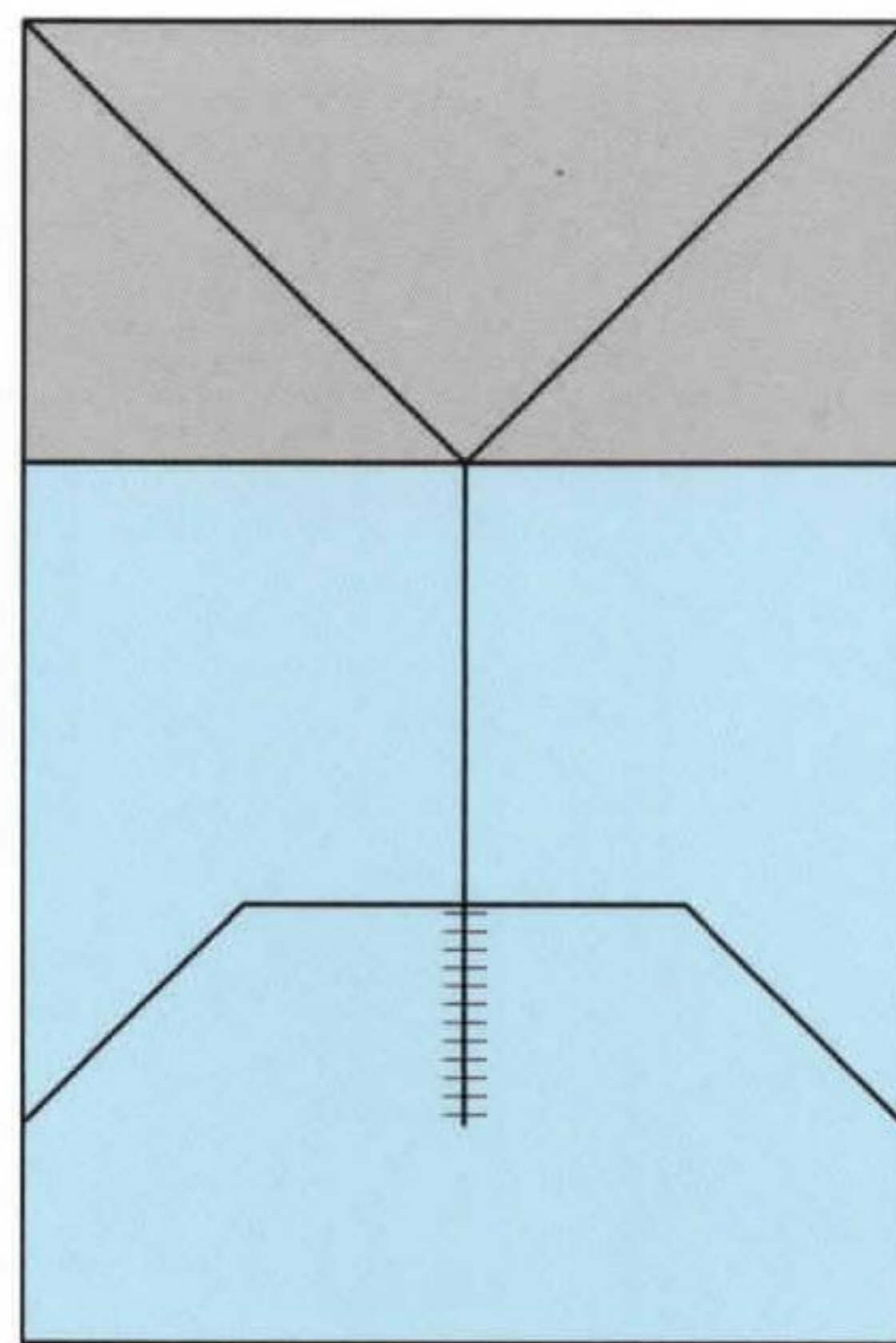

9. Cut as shown

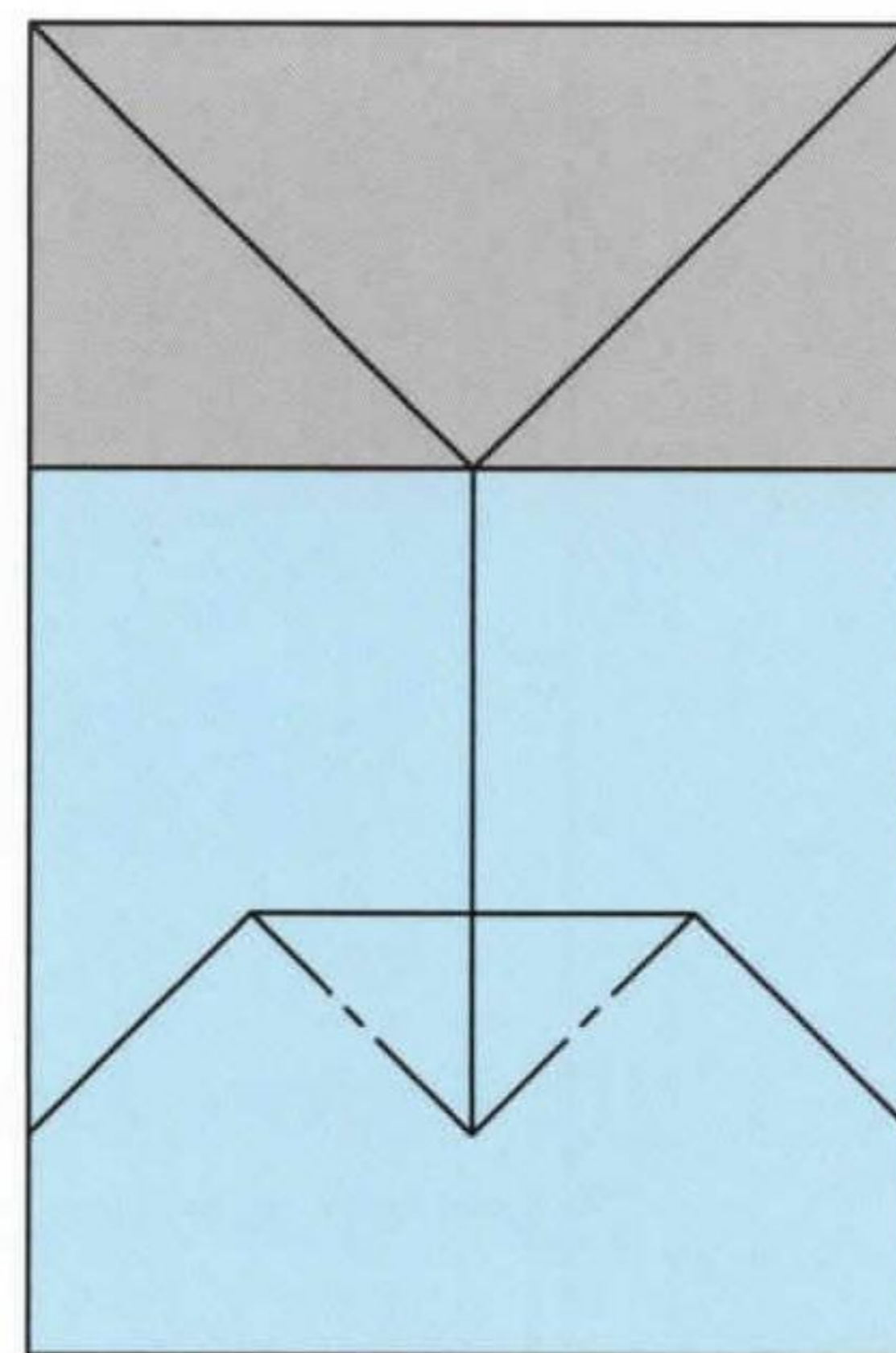

10. Mountain folds

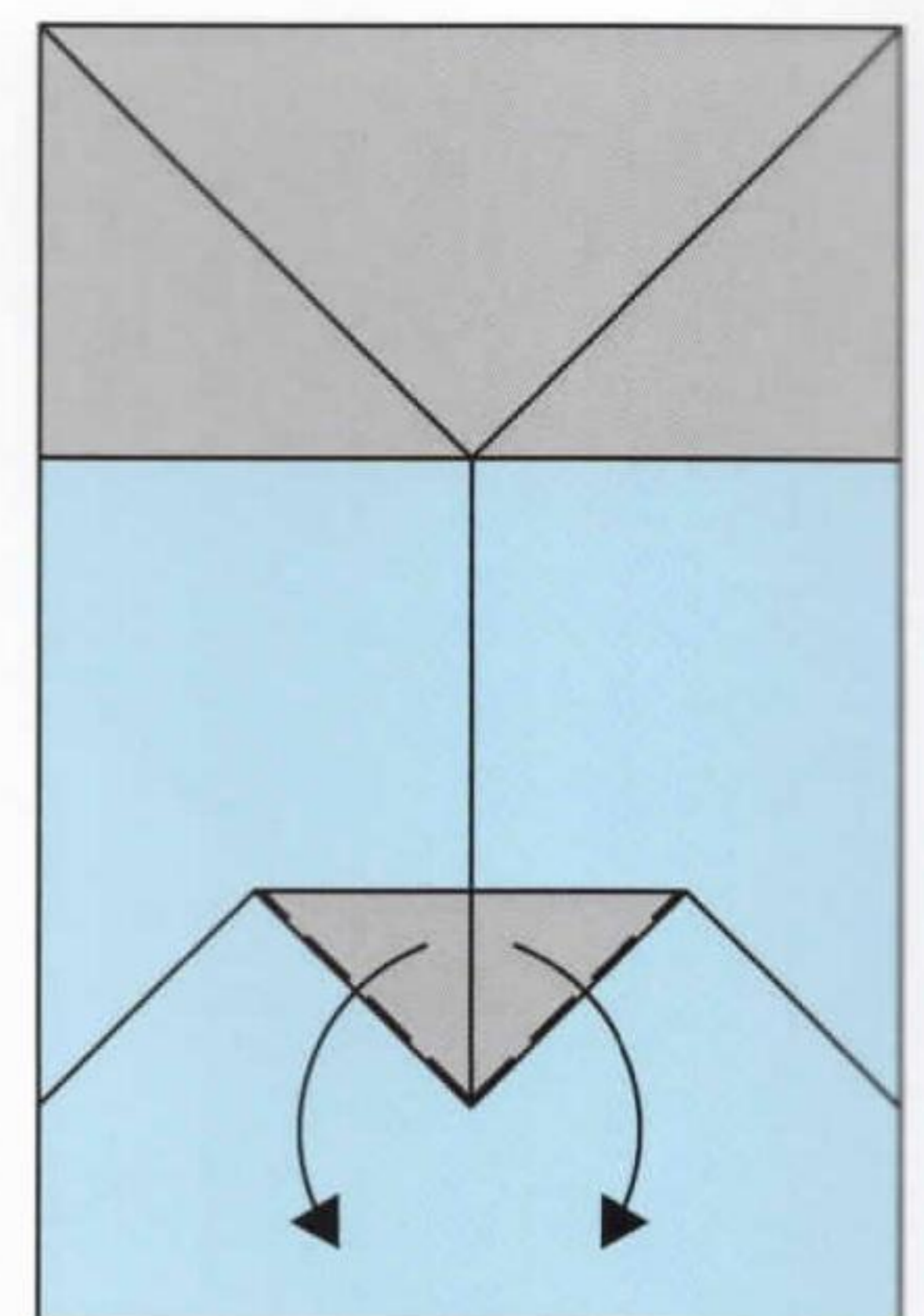

11. Valley folds

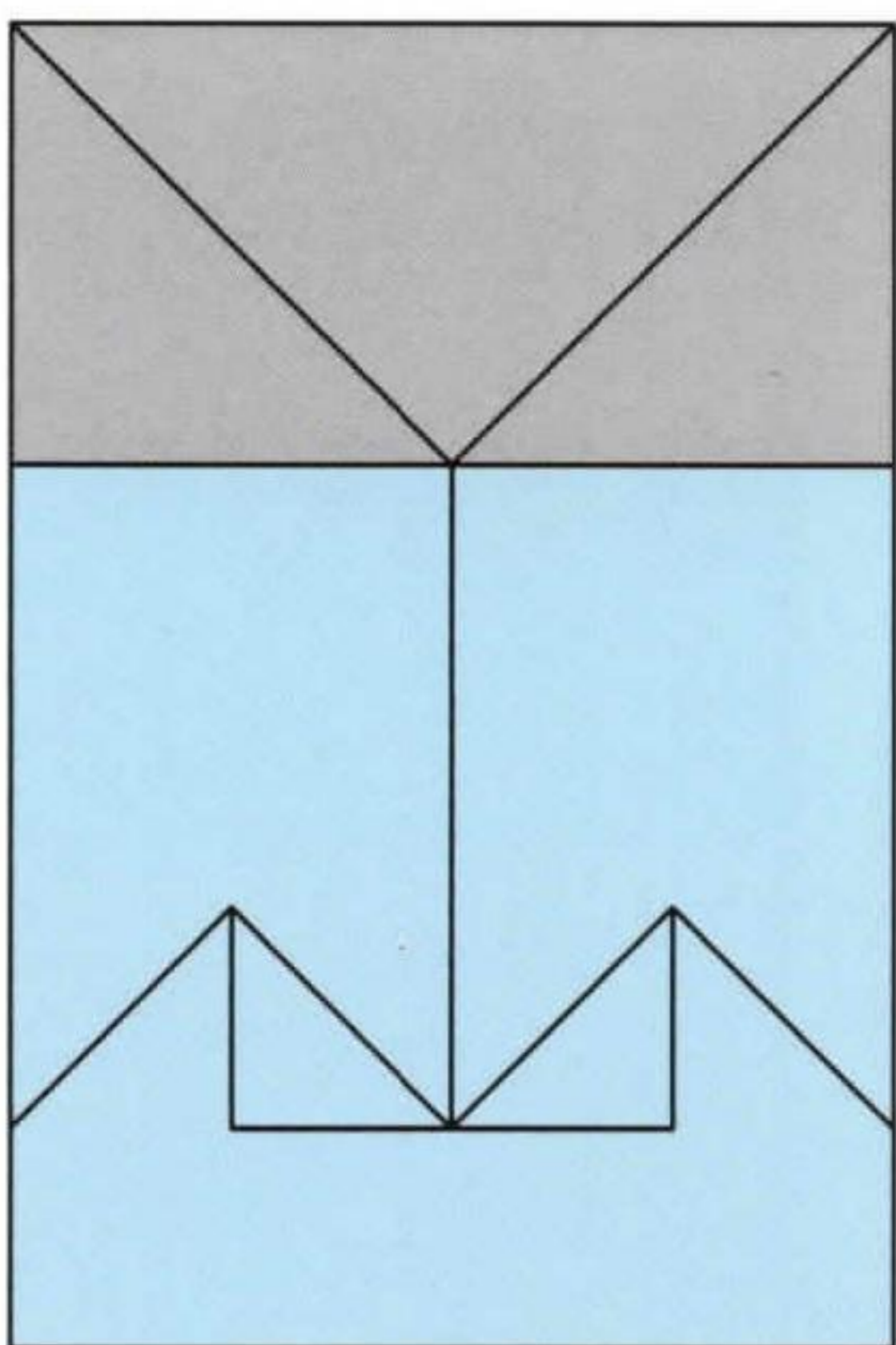

12. Hide behind layers

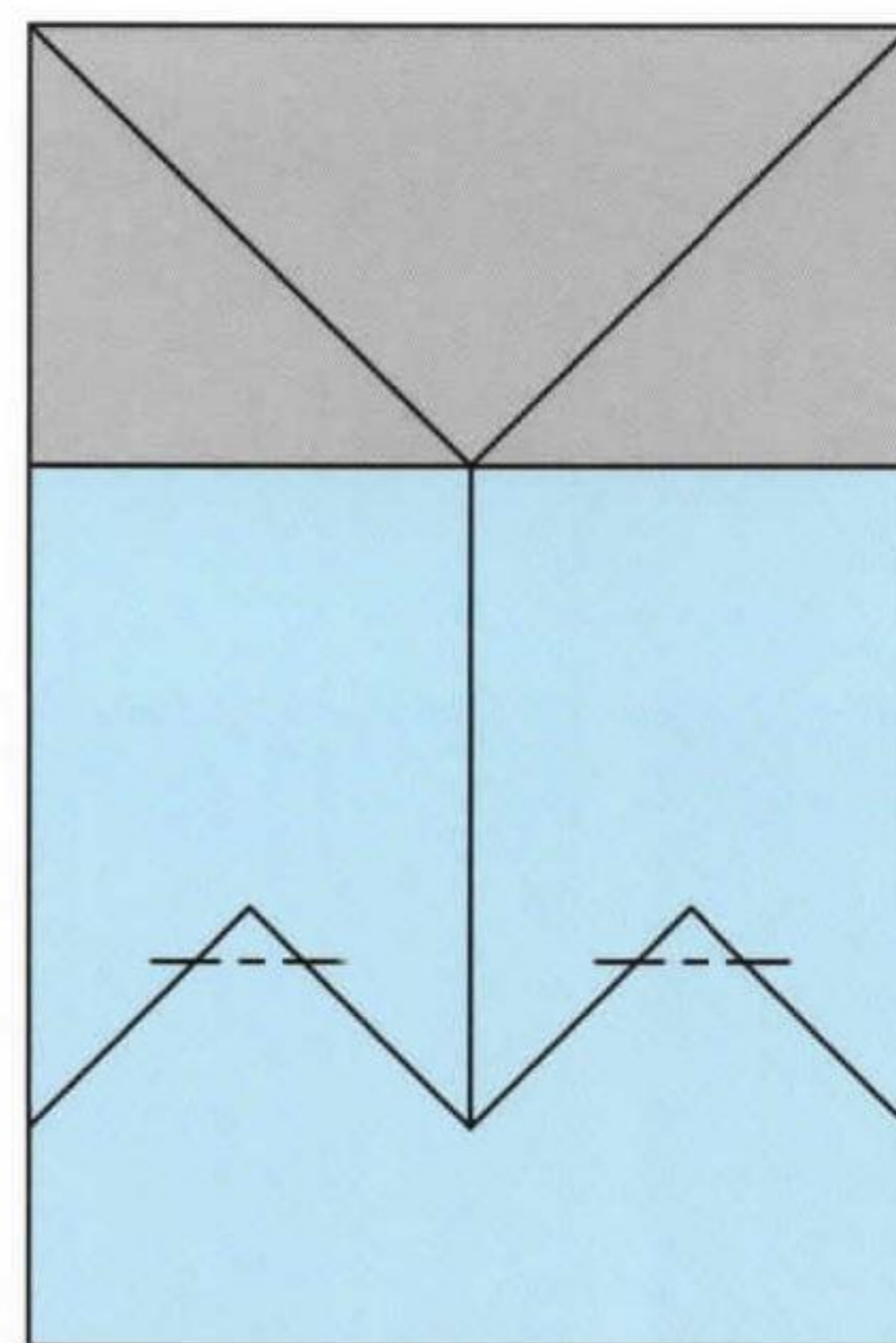

13. Repeat steps 10 to 12

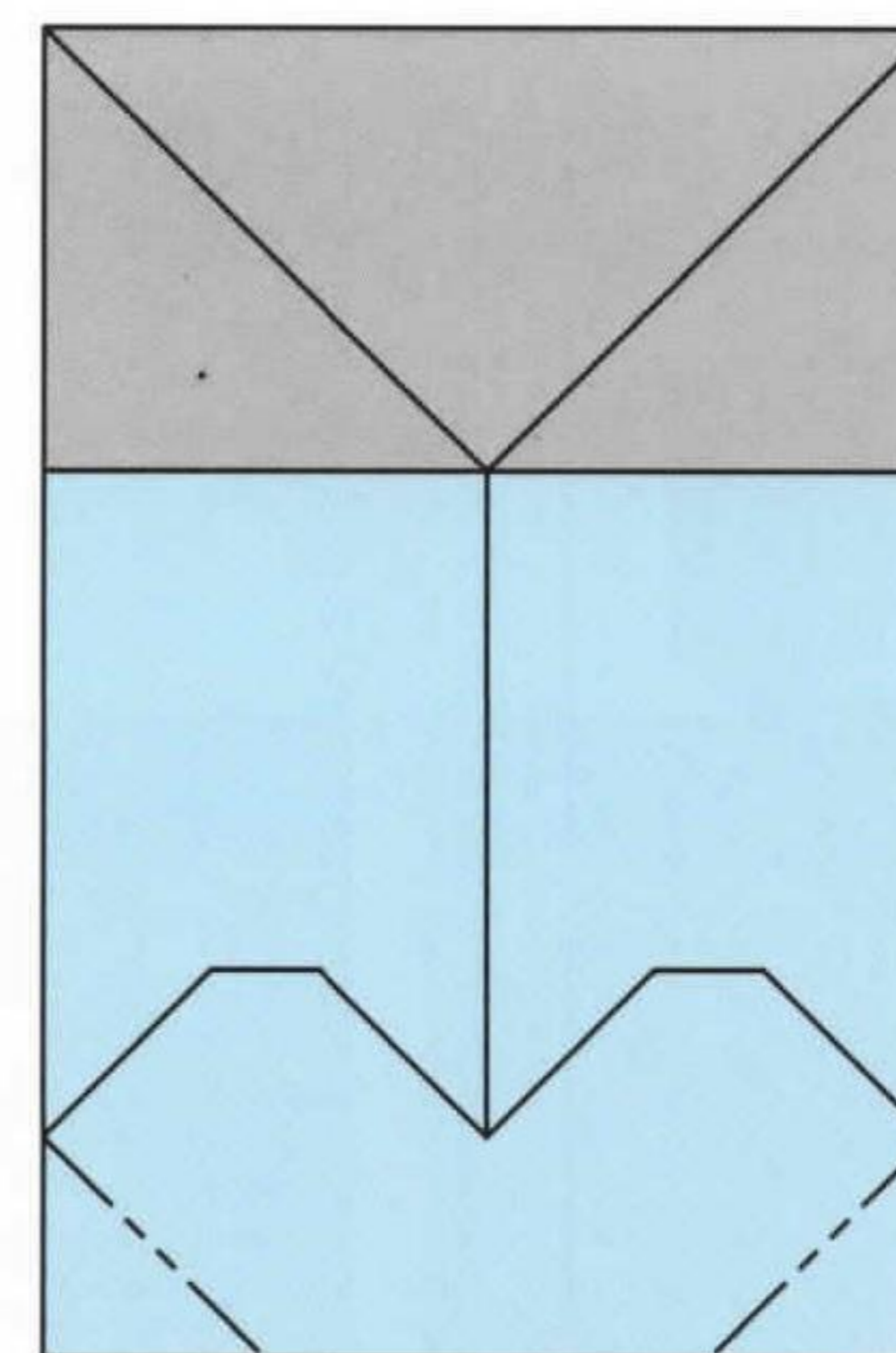

14. Inside reverse folds

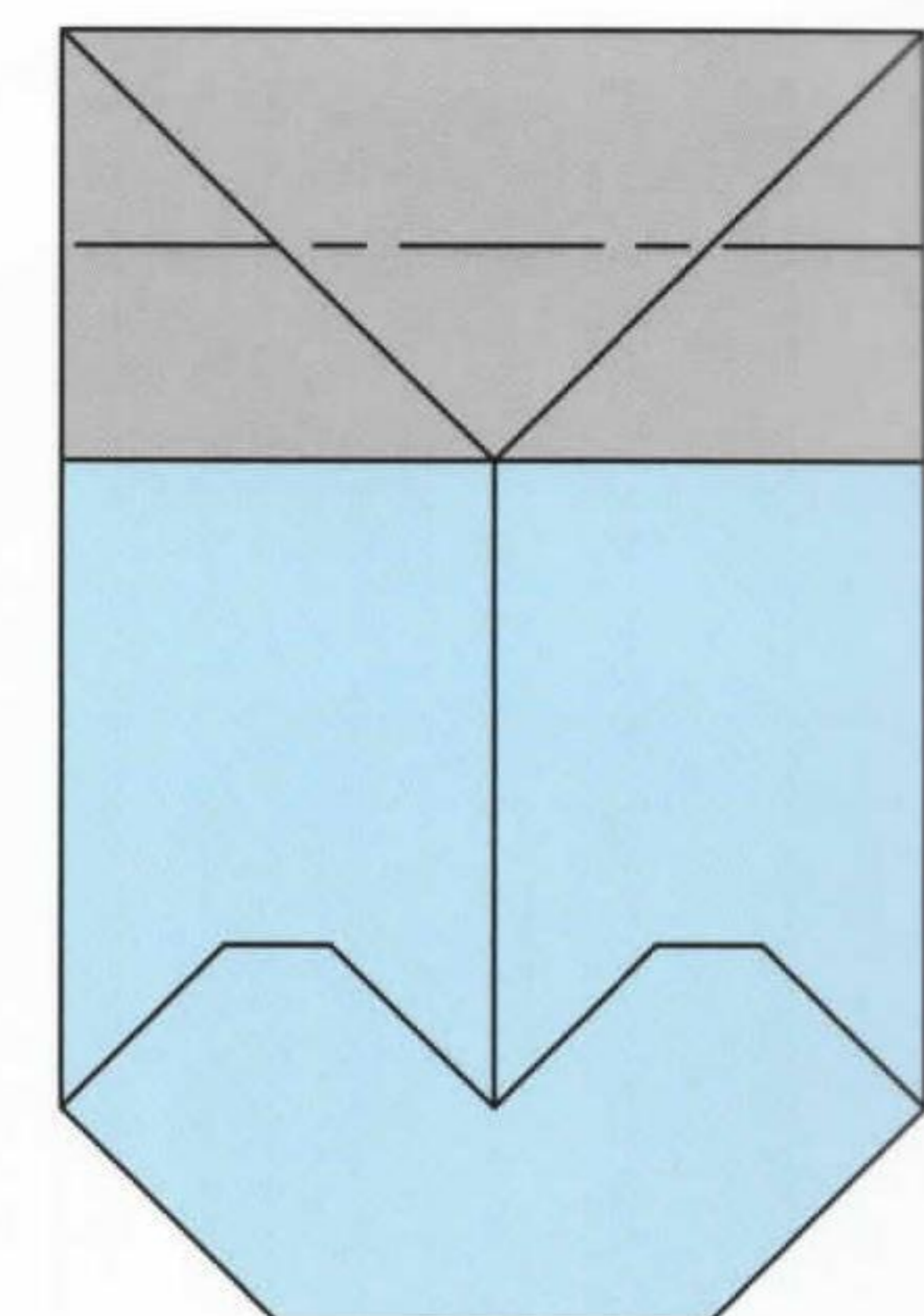

15. Mountain fold

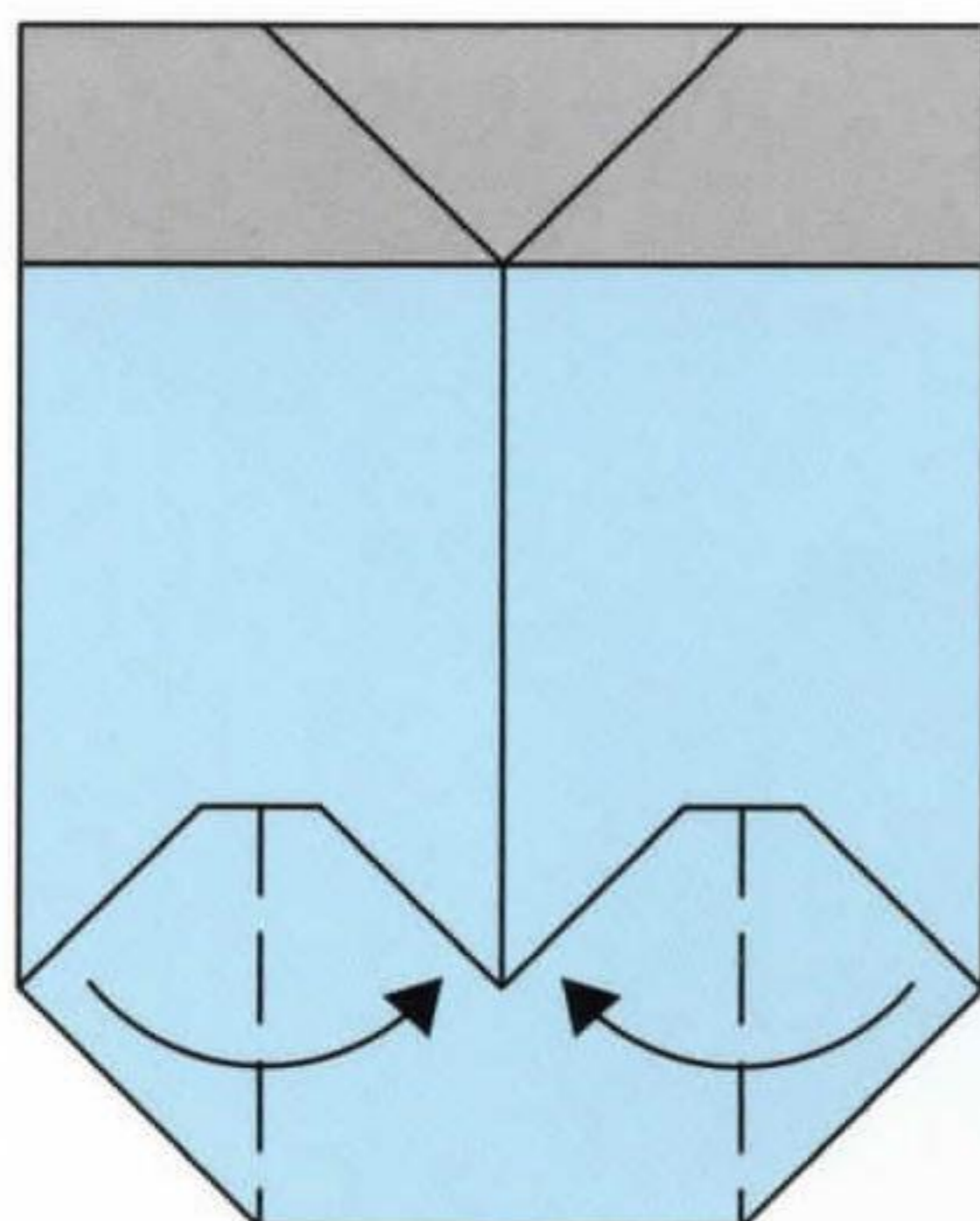

16. Valley folds

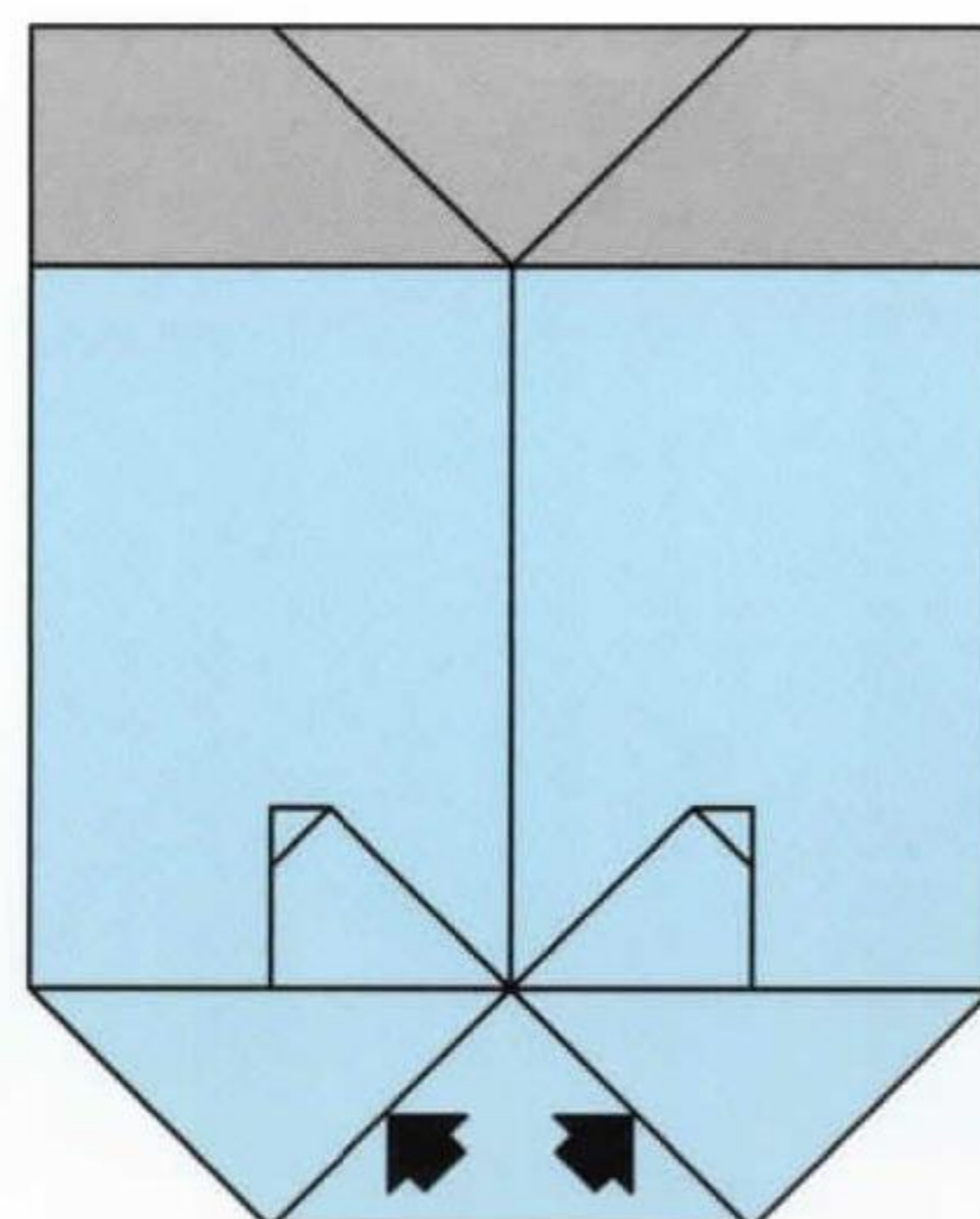

17. Apply glue

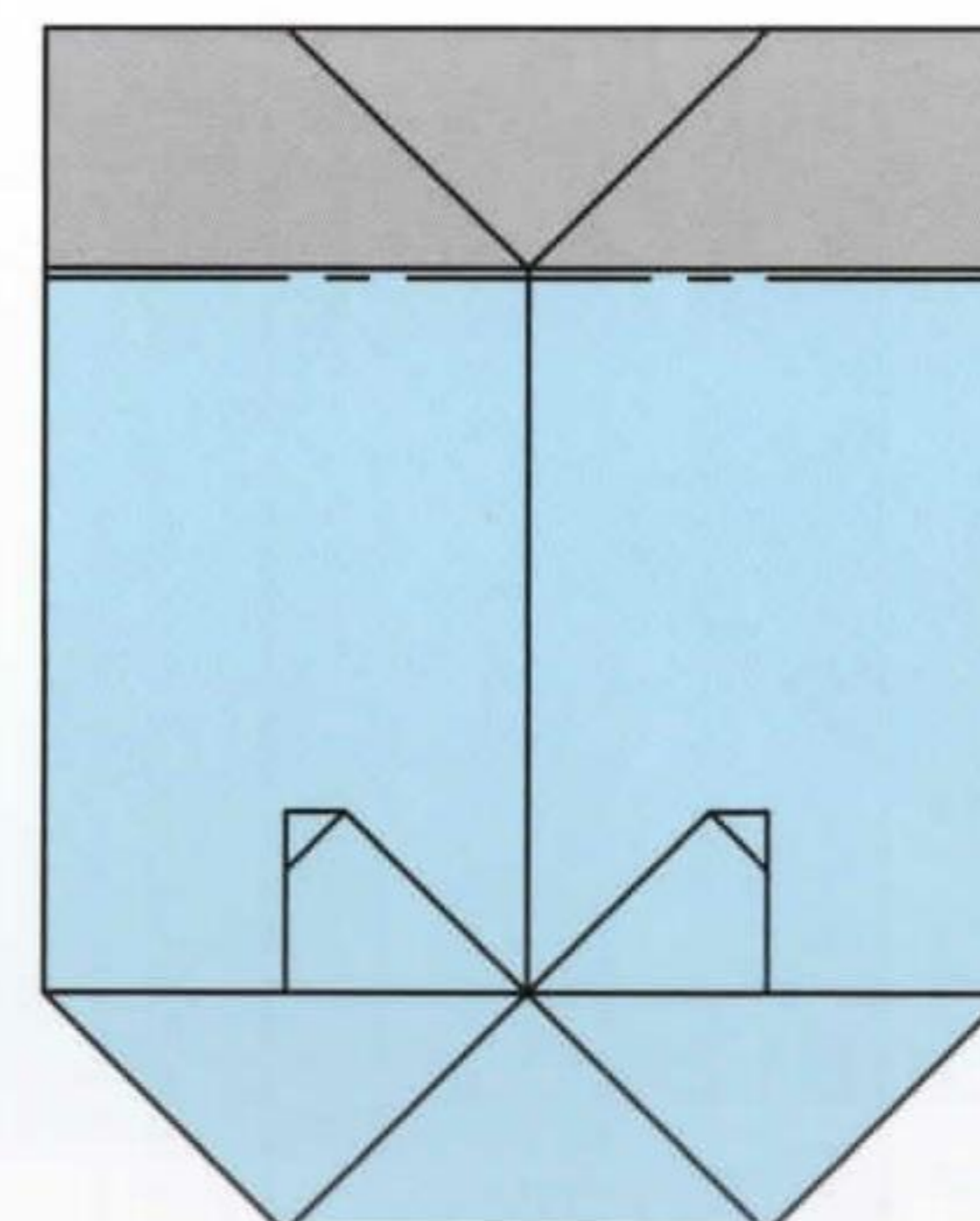

18. Mountain fold

divan bed: part 2

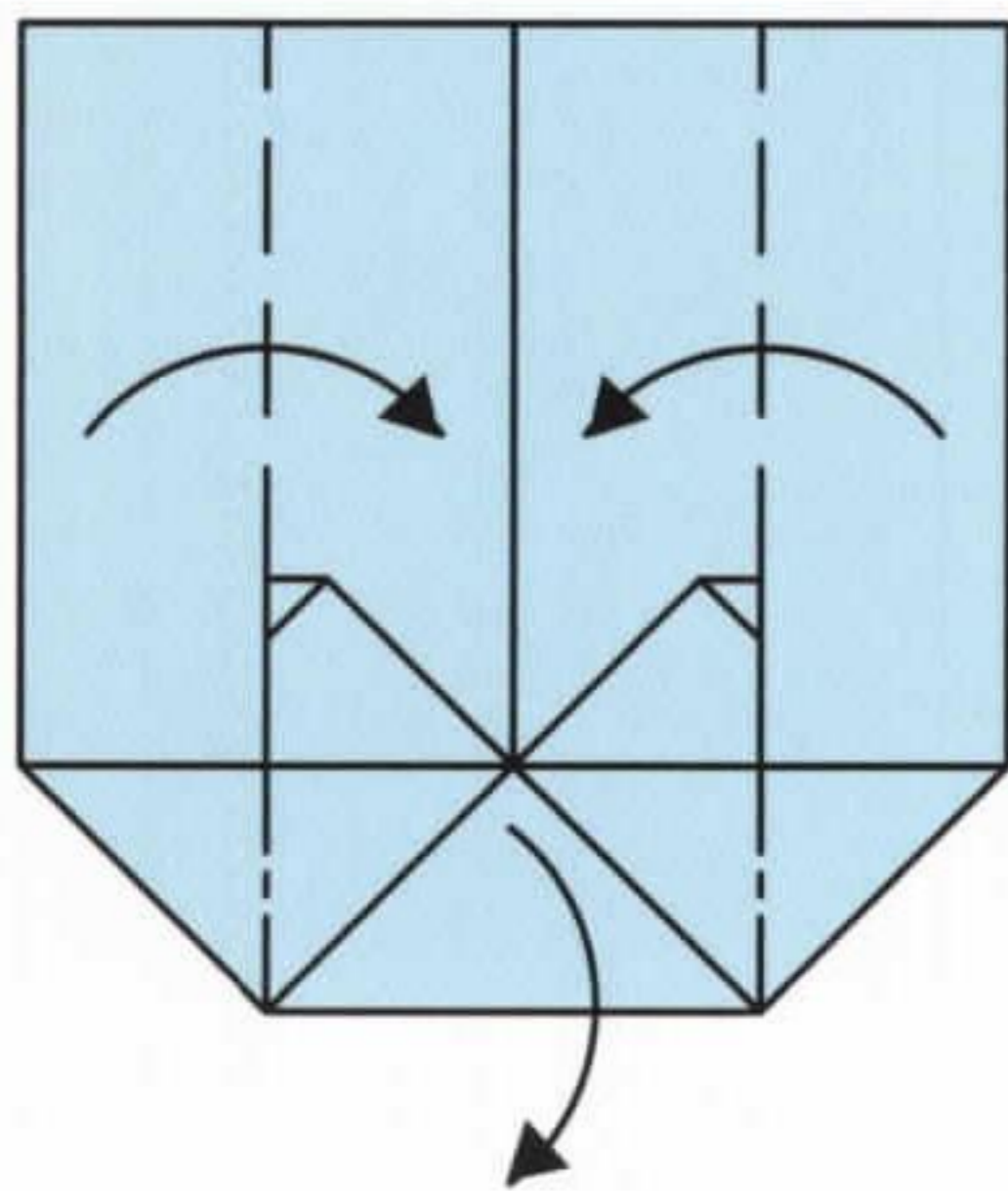

19. Pull and fold

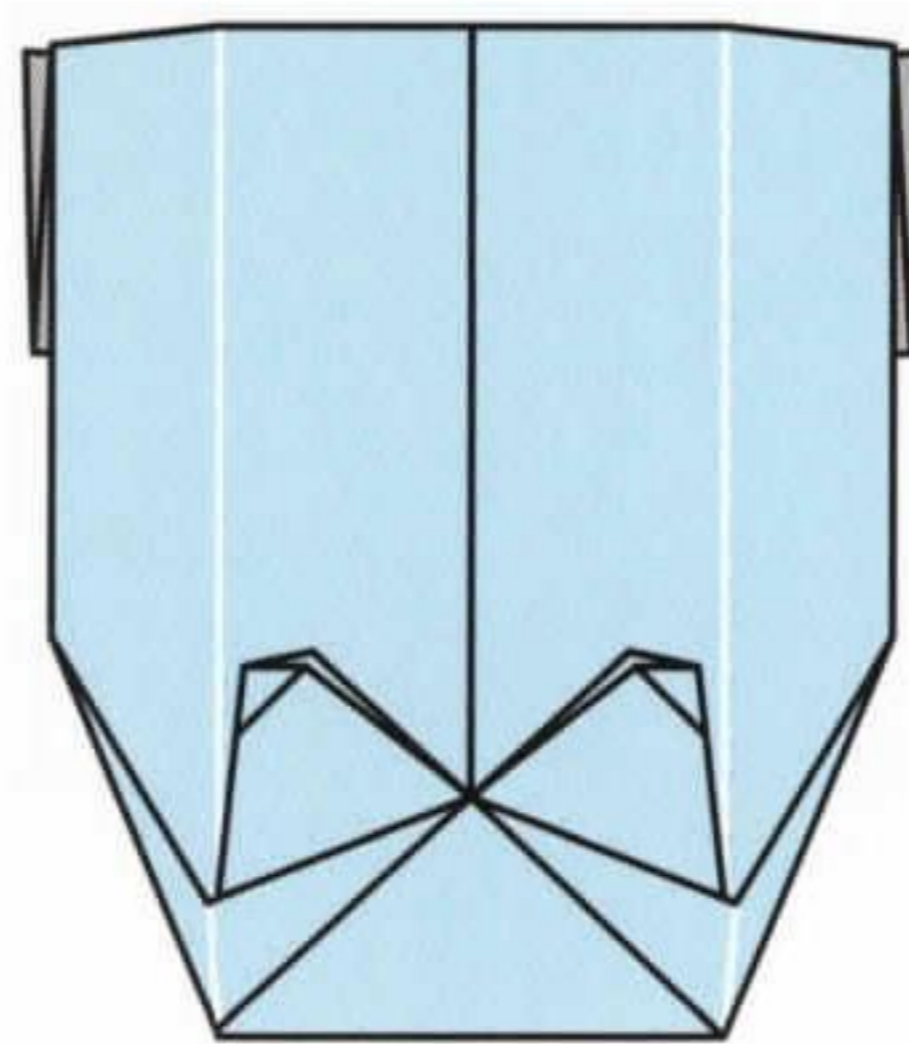

20. Before complete.
Turn over and rotate

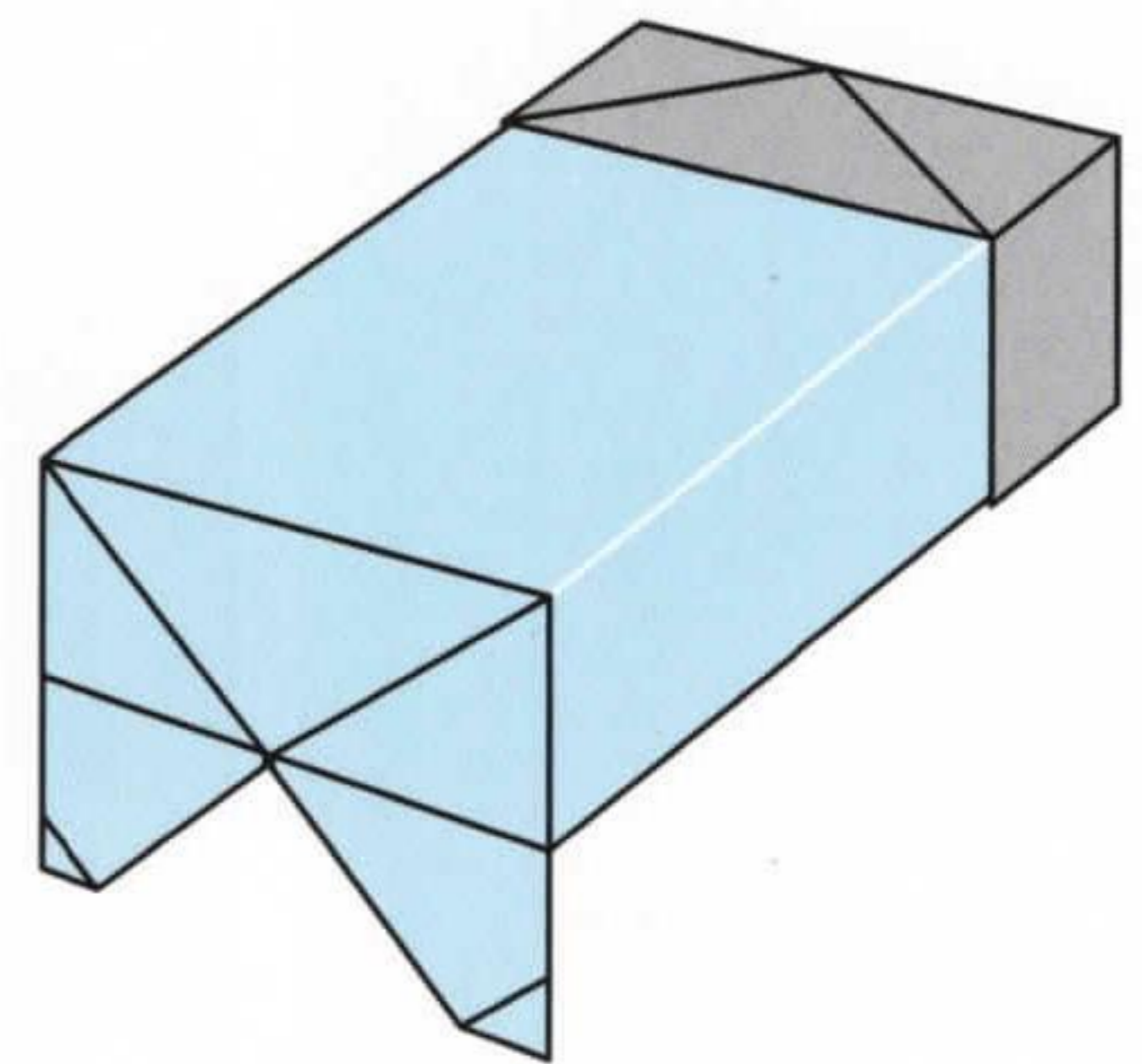
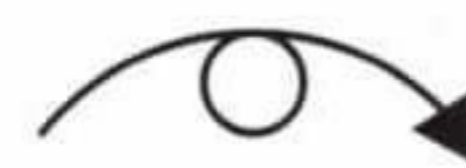

21. Completed PART 2

ASSEMBLY

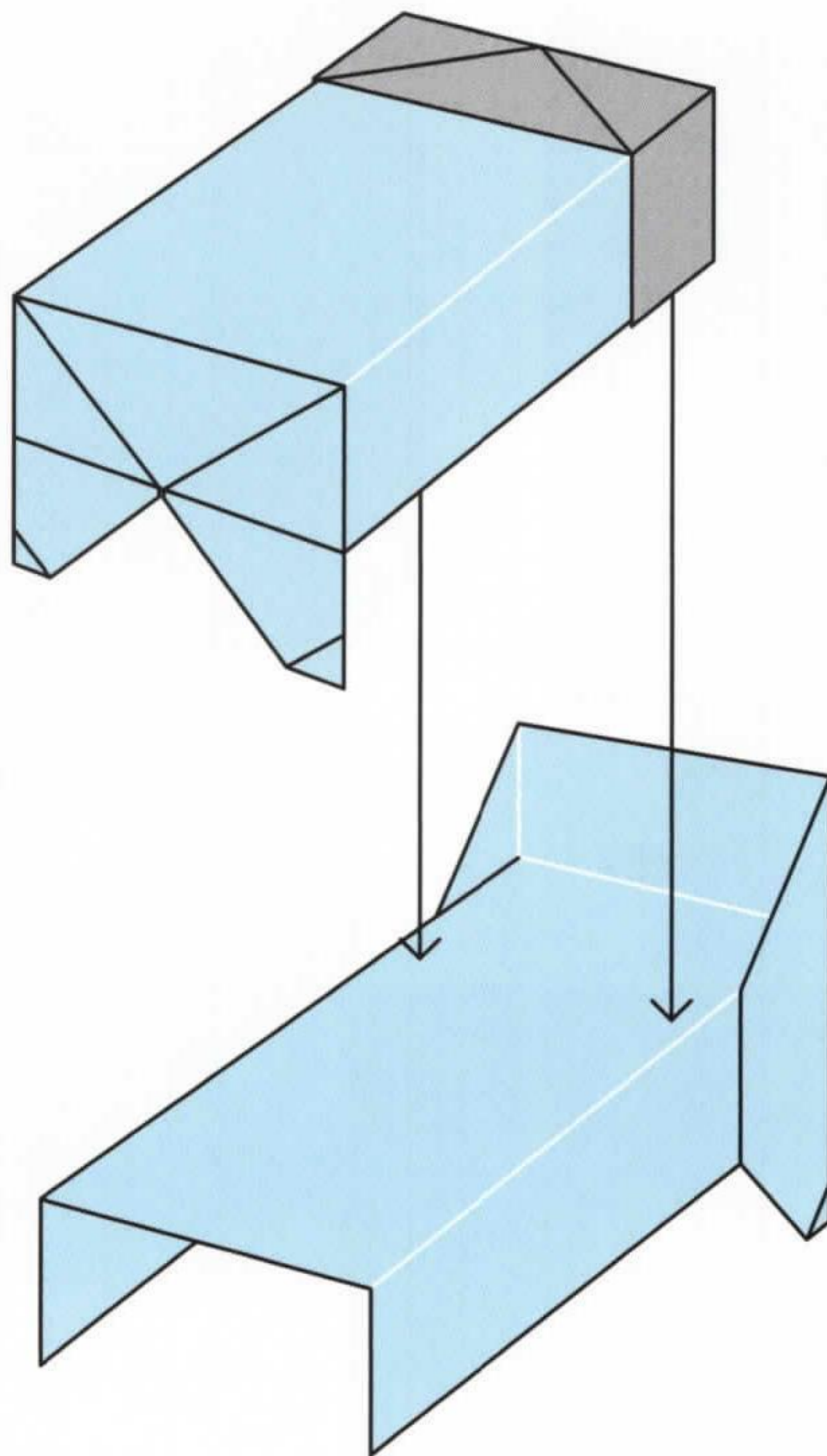

1. Join both parts
together as shown
and apply glue to hold

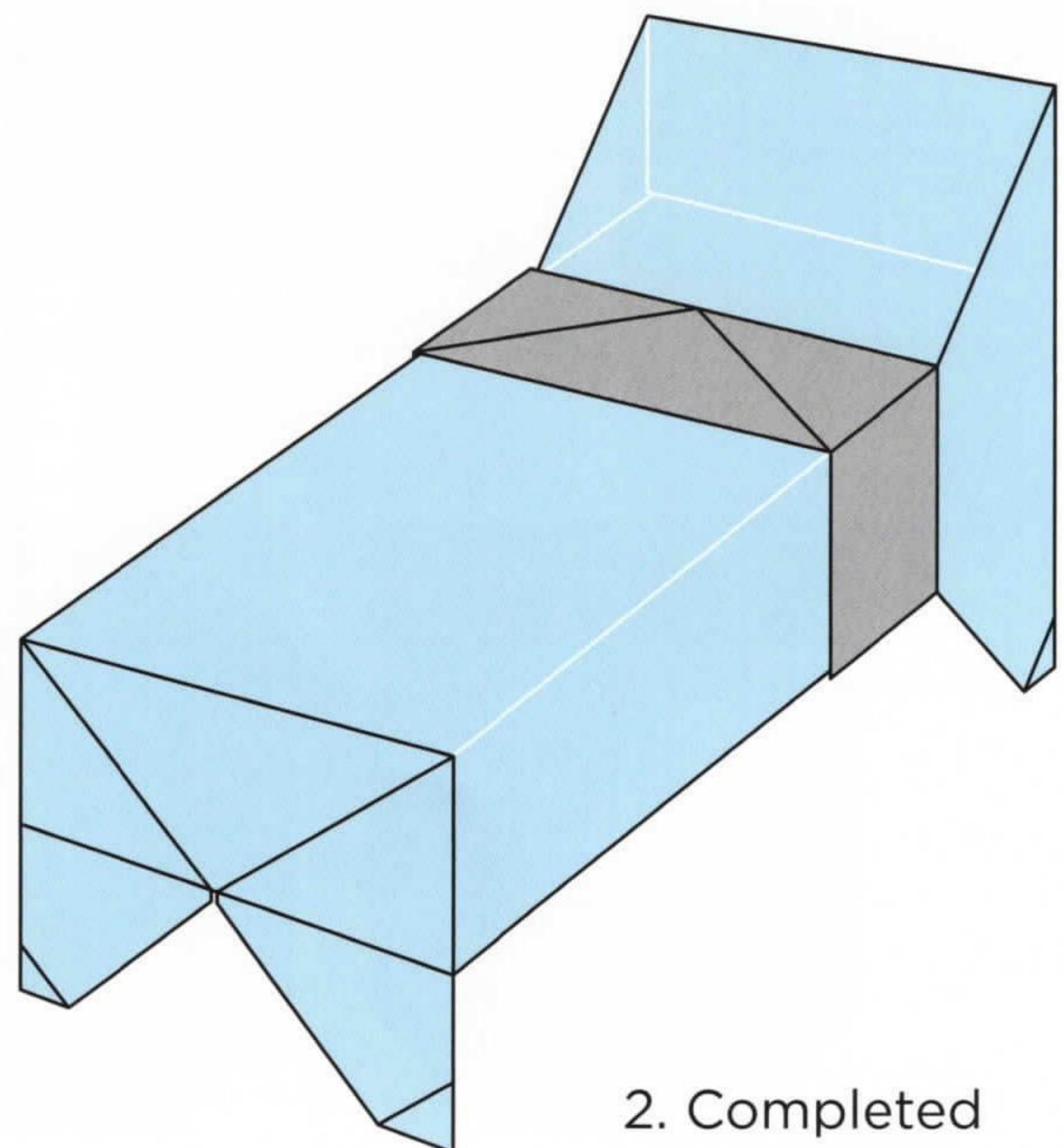

2. Completed
DIVAN BED

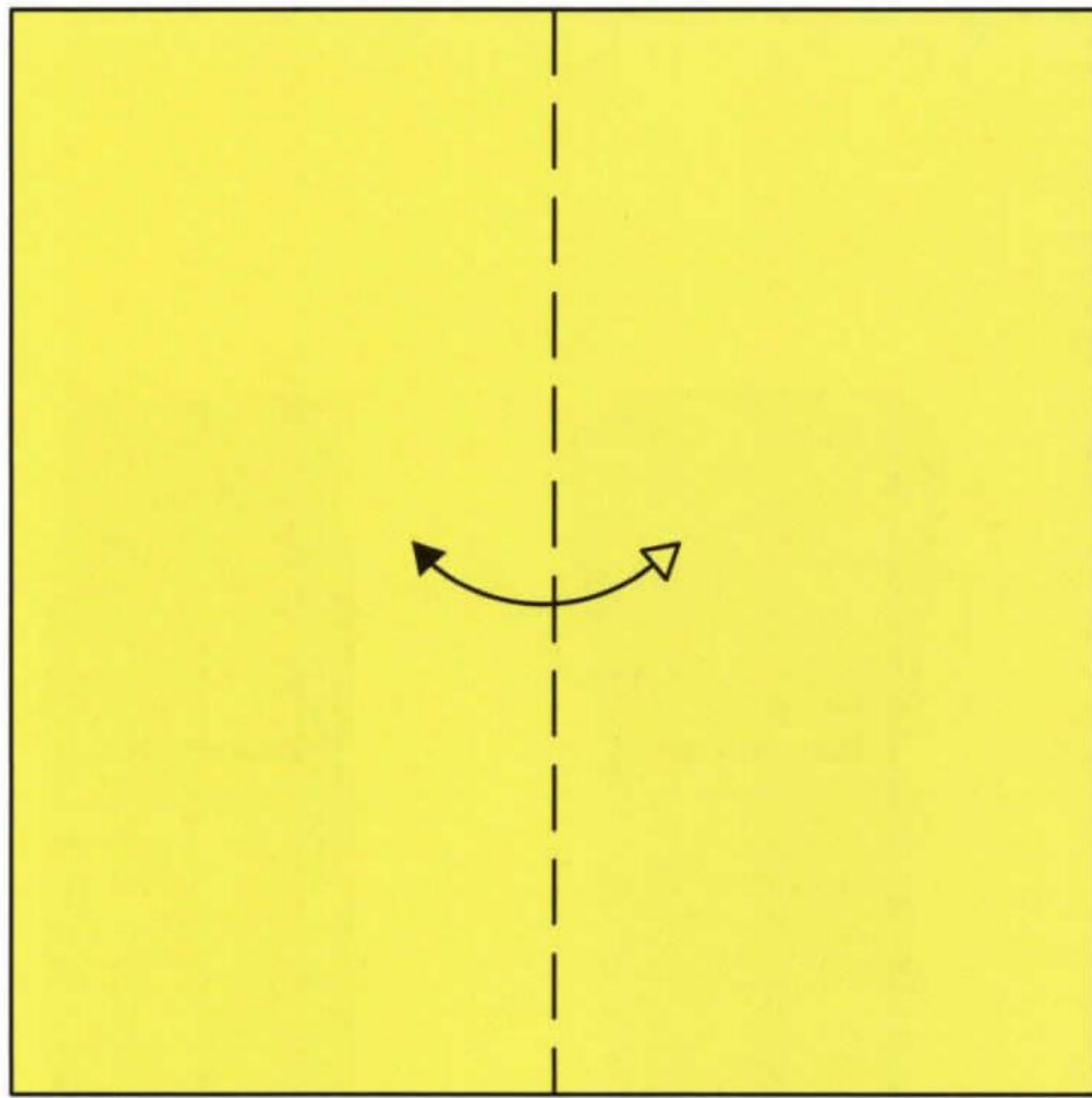

1. Valley fold and unfold

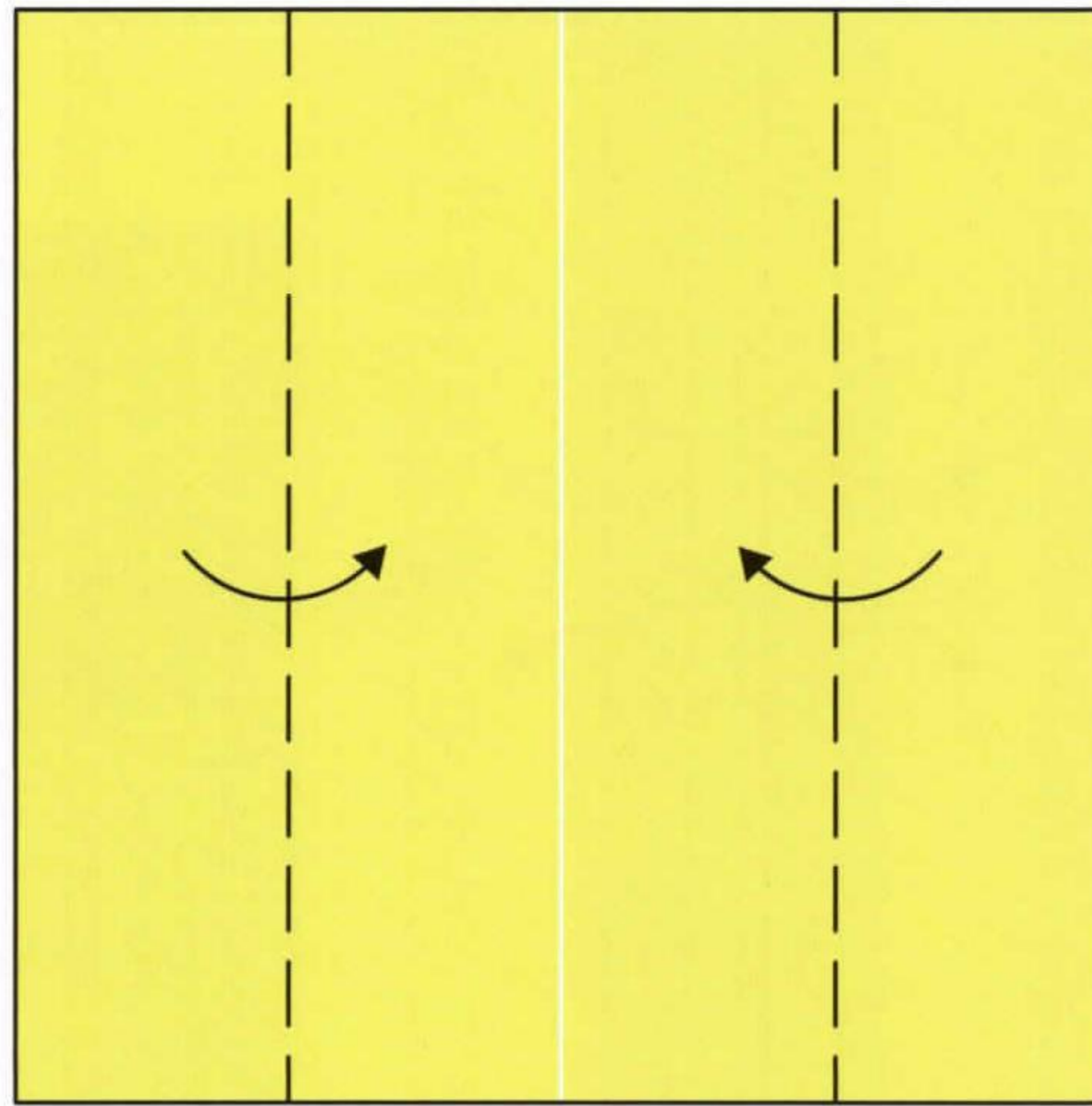

2. Valley folds

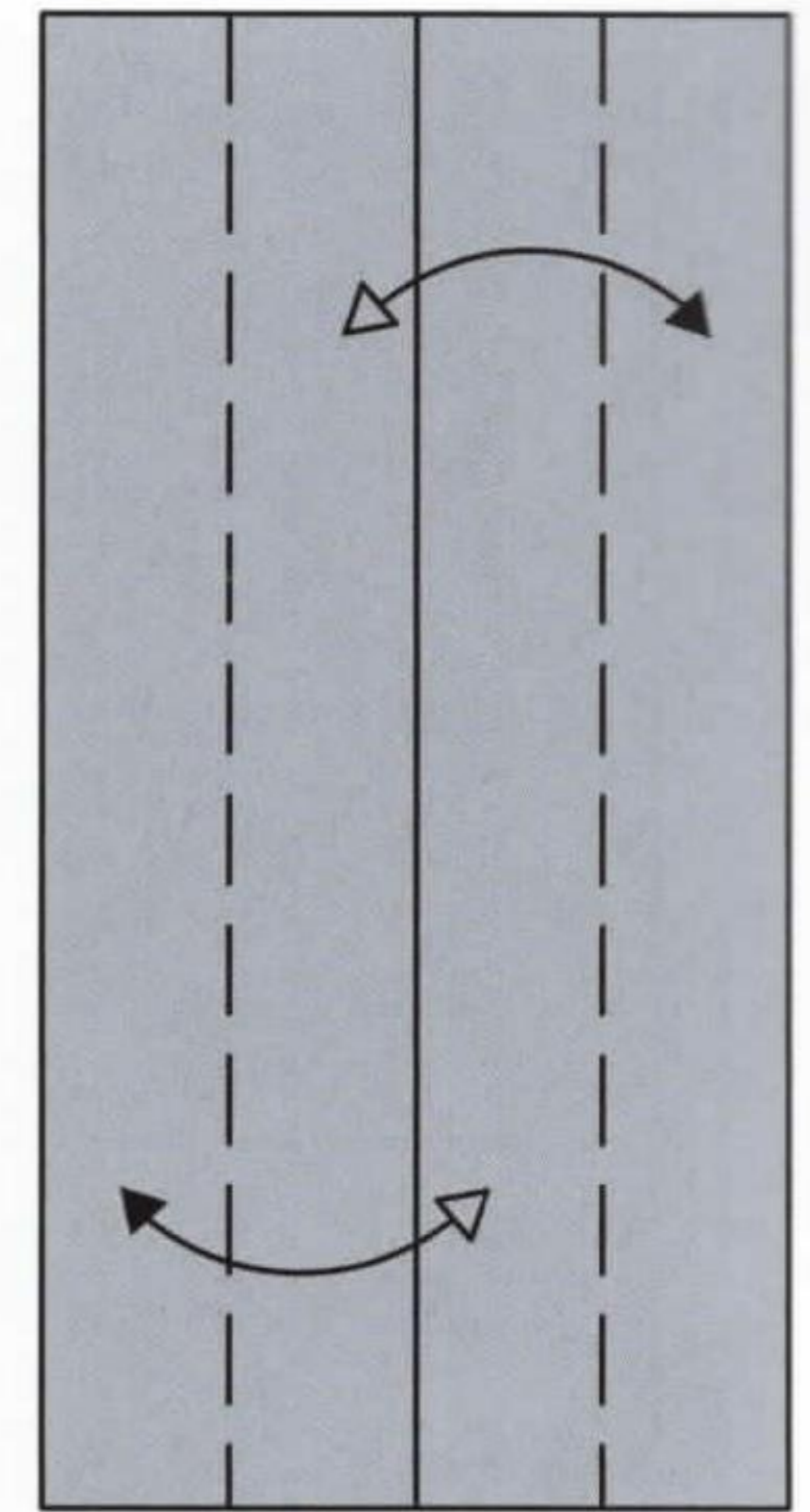

3. Valley folds and unfold

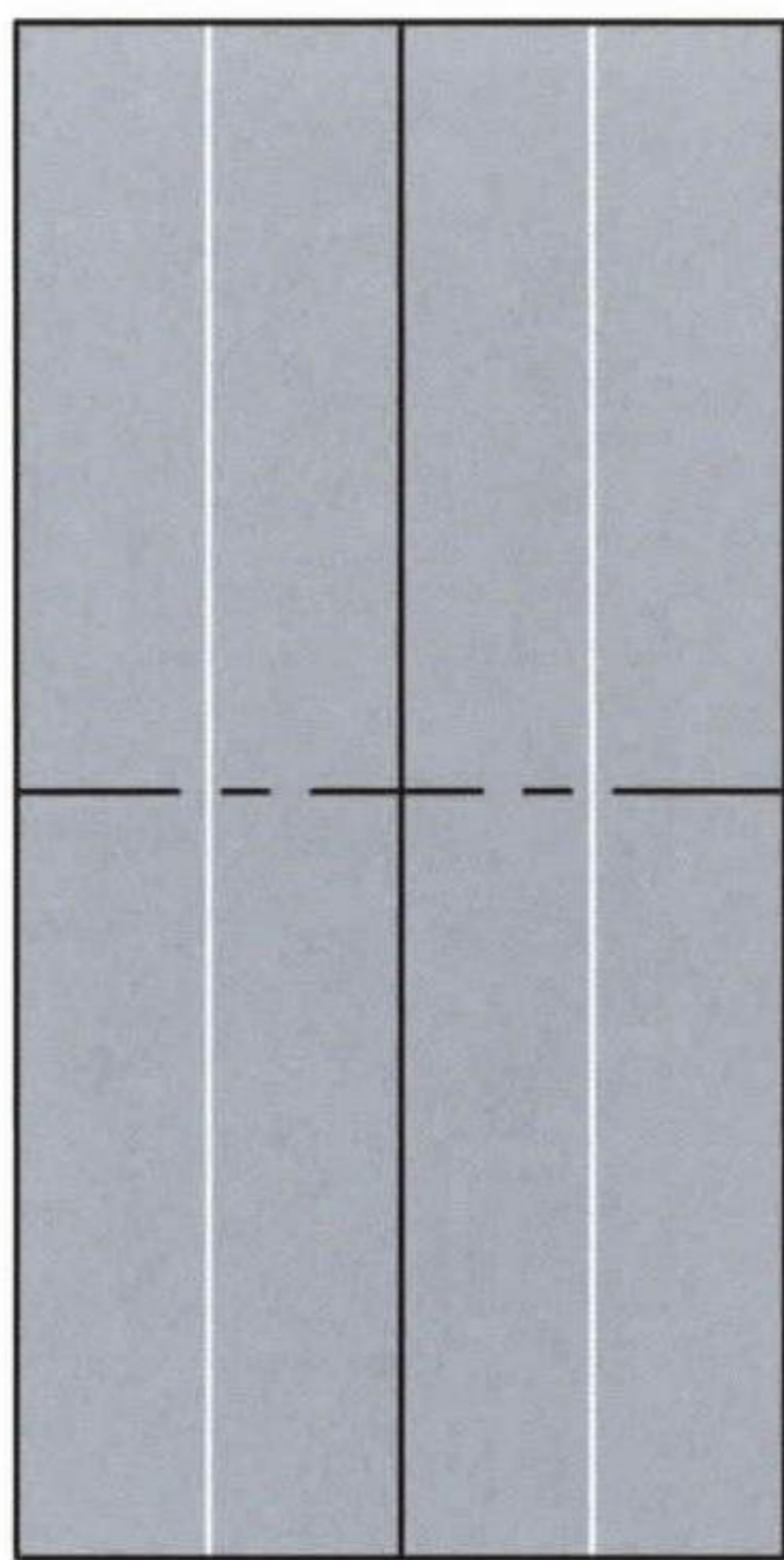

4. Mountain fold

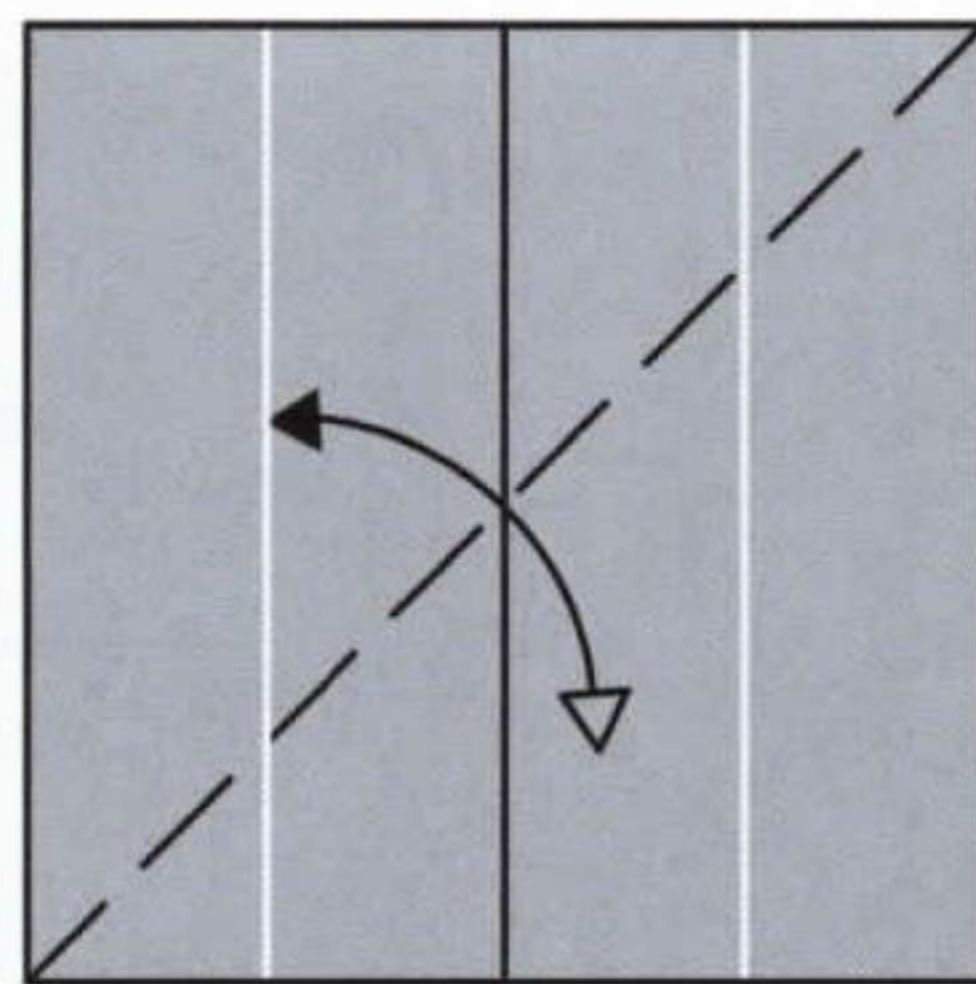

5. Valley fold and unfold

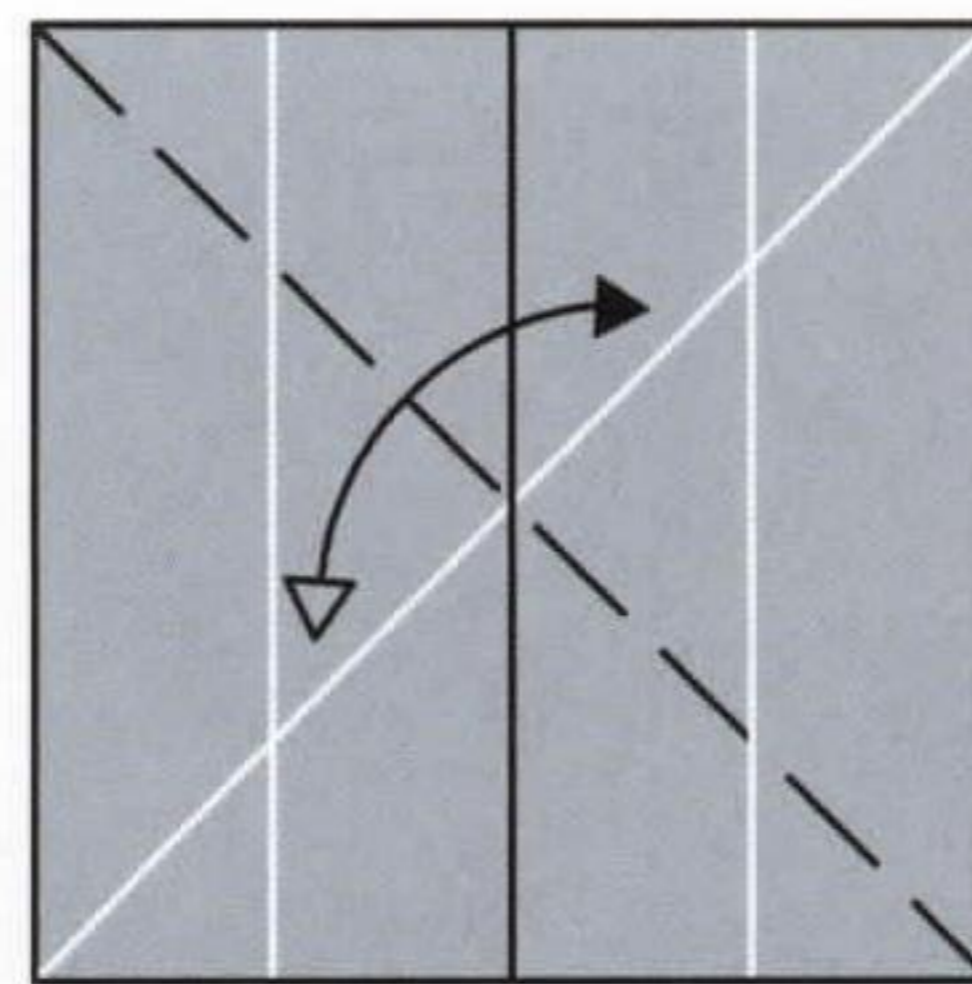

6. Repeat

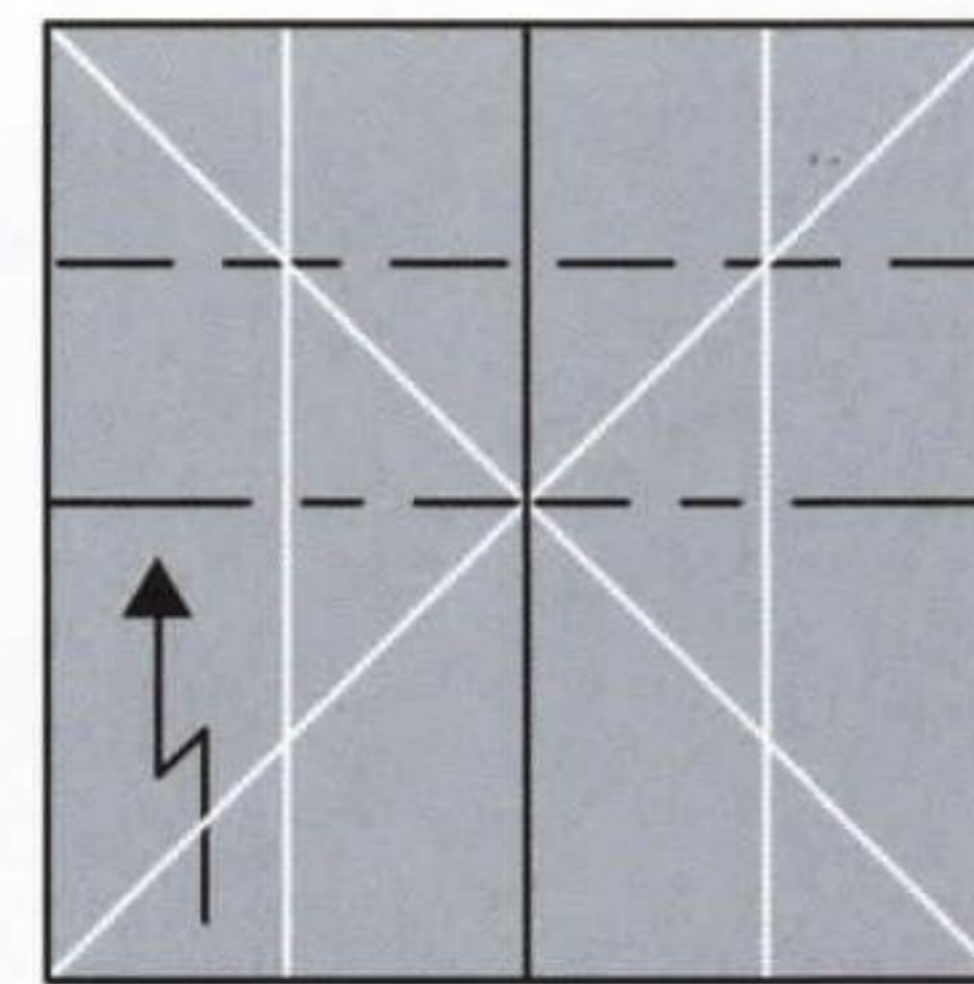

7. Pleat fold

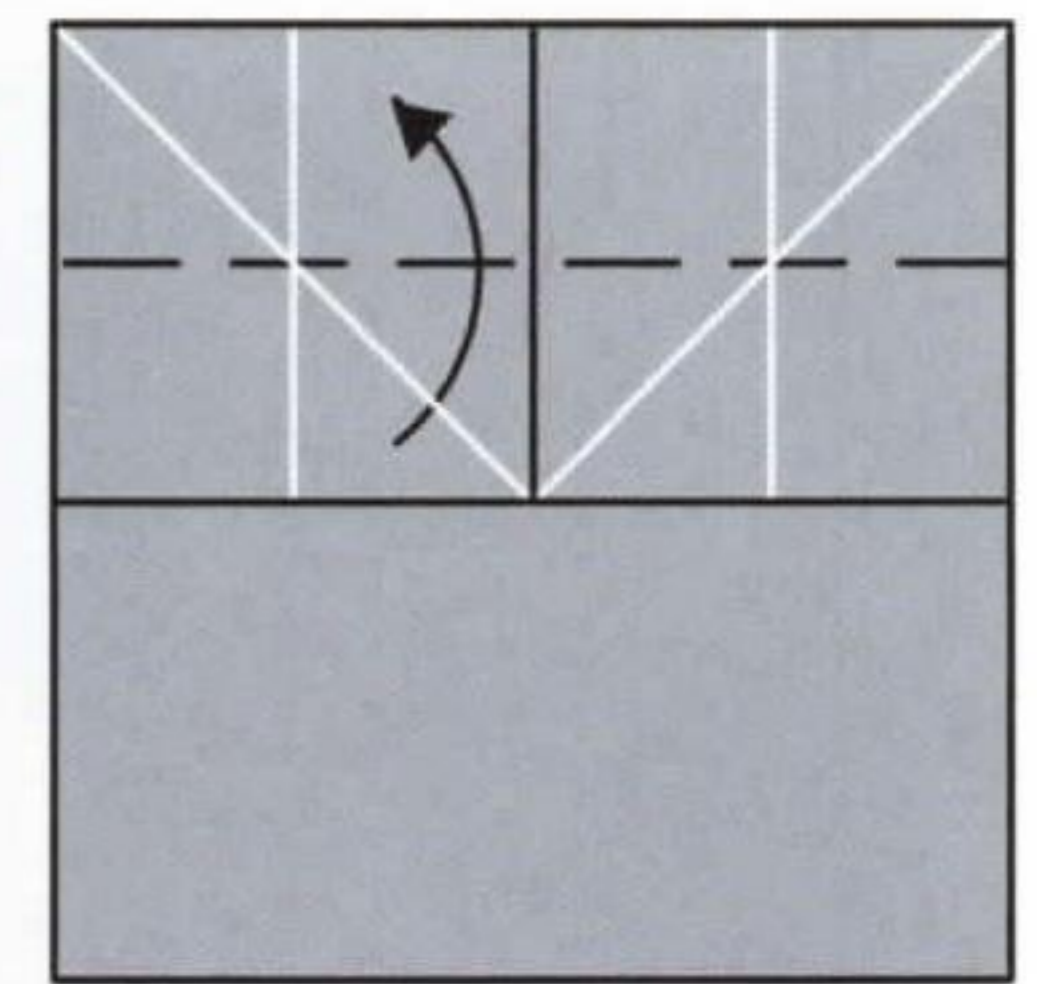

8. Valley fold

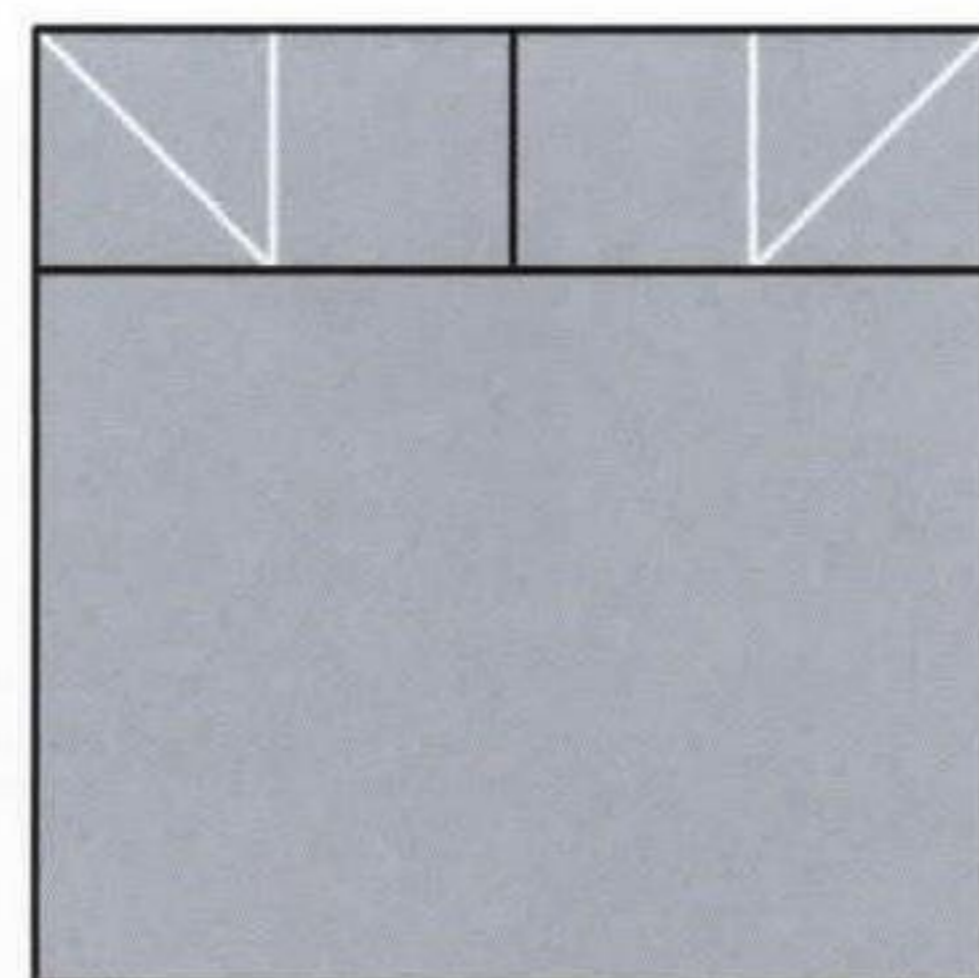

9. Turn over

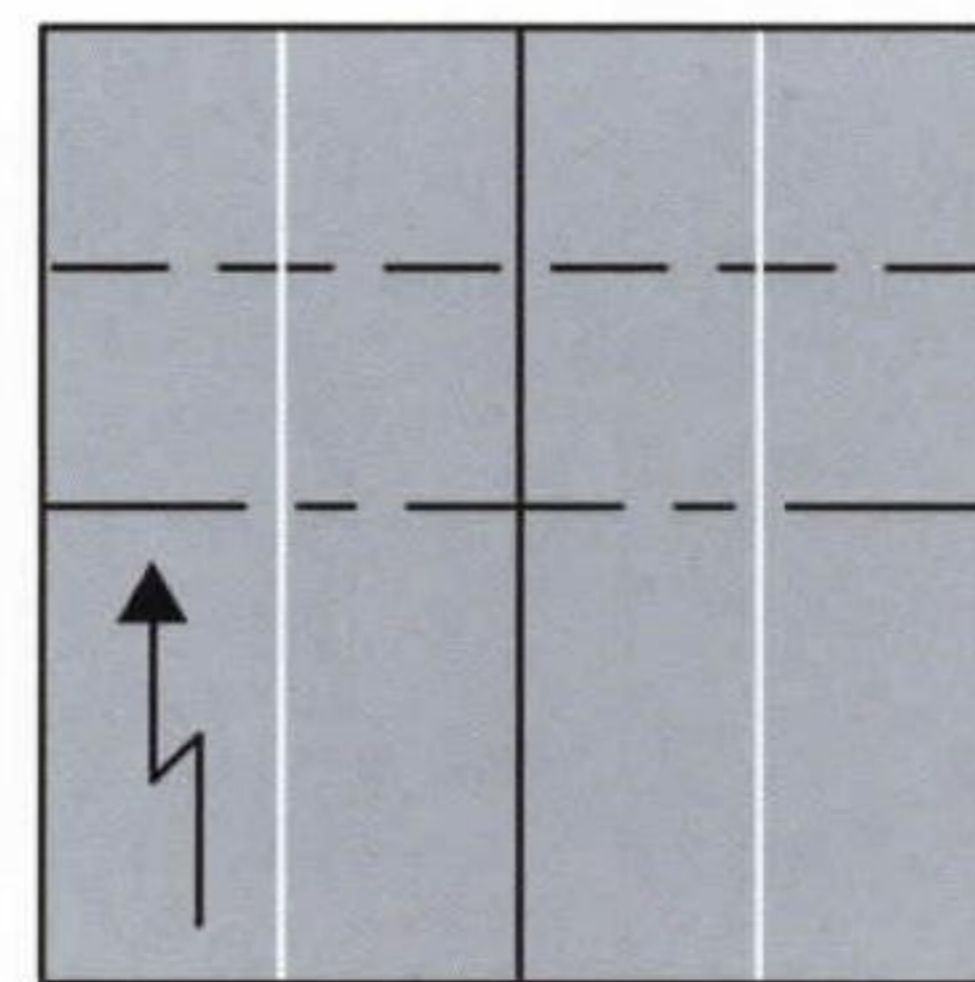

10. Repeat steps 5 to 8

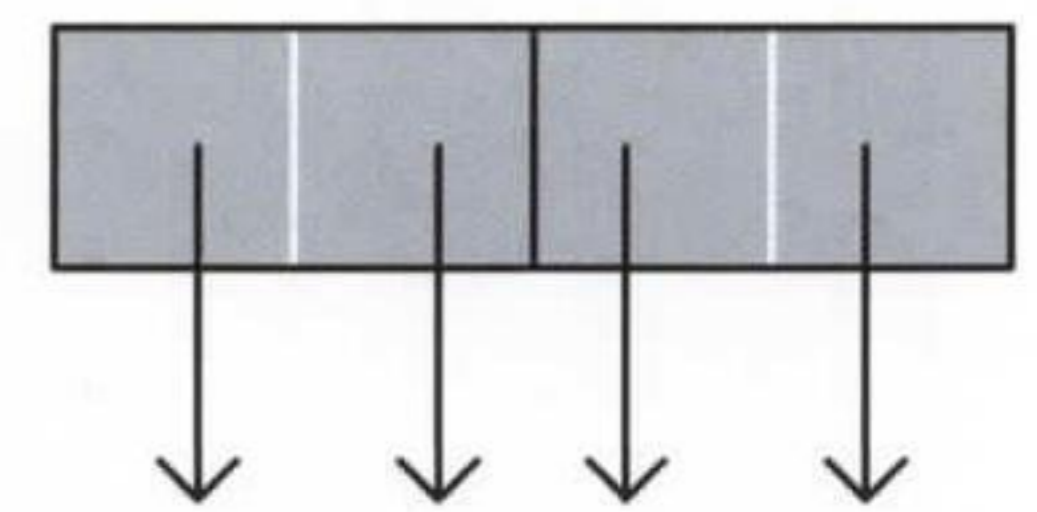

11. Unfold both sides

dresser: part 1

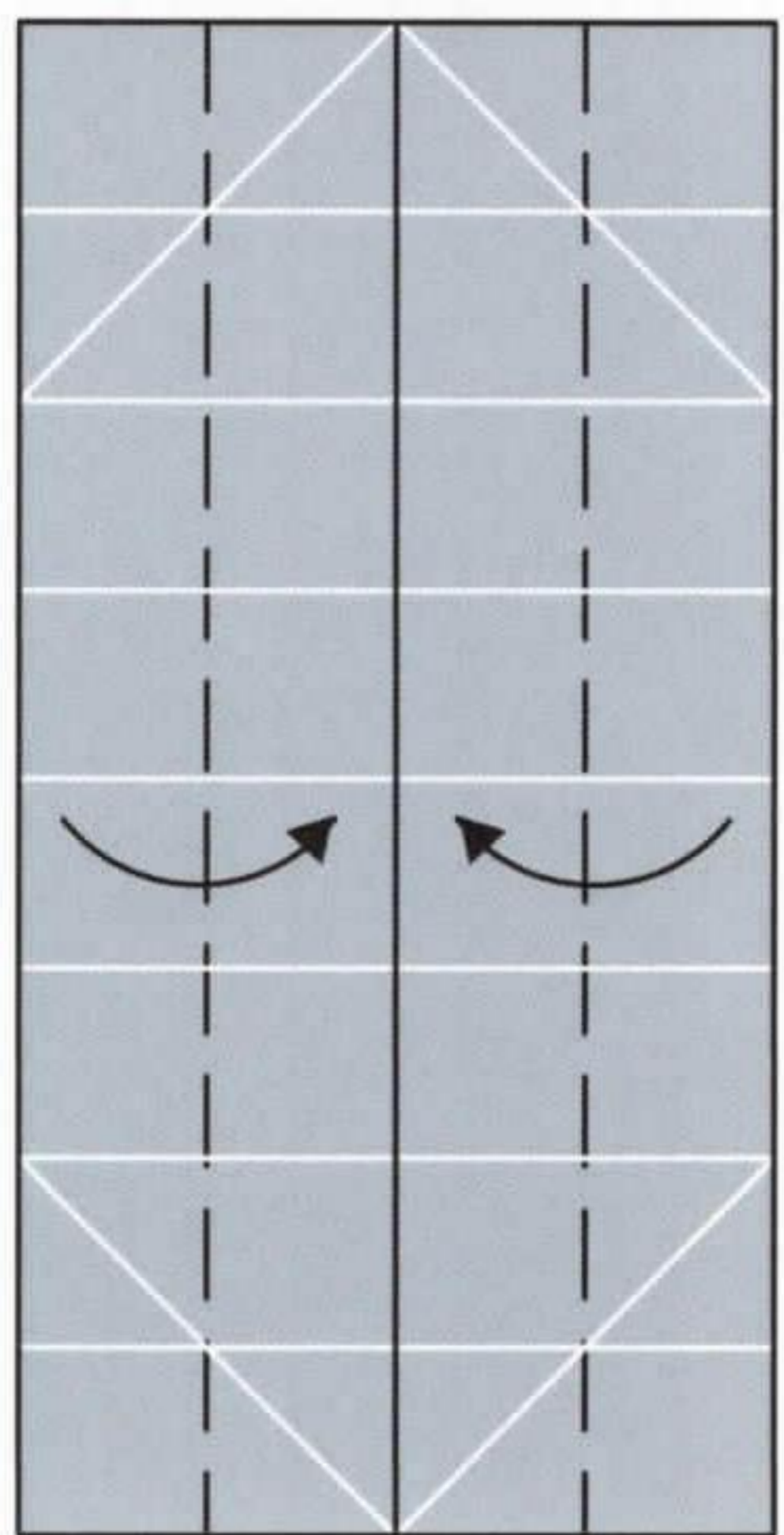

12. Valley folds

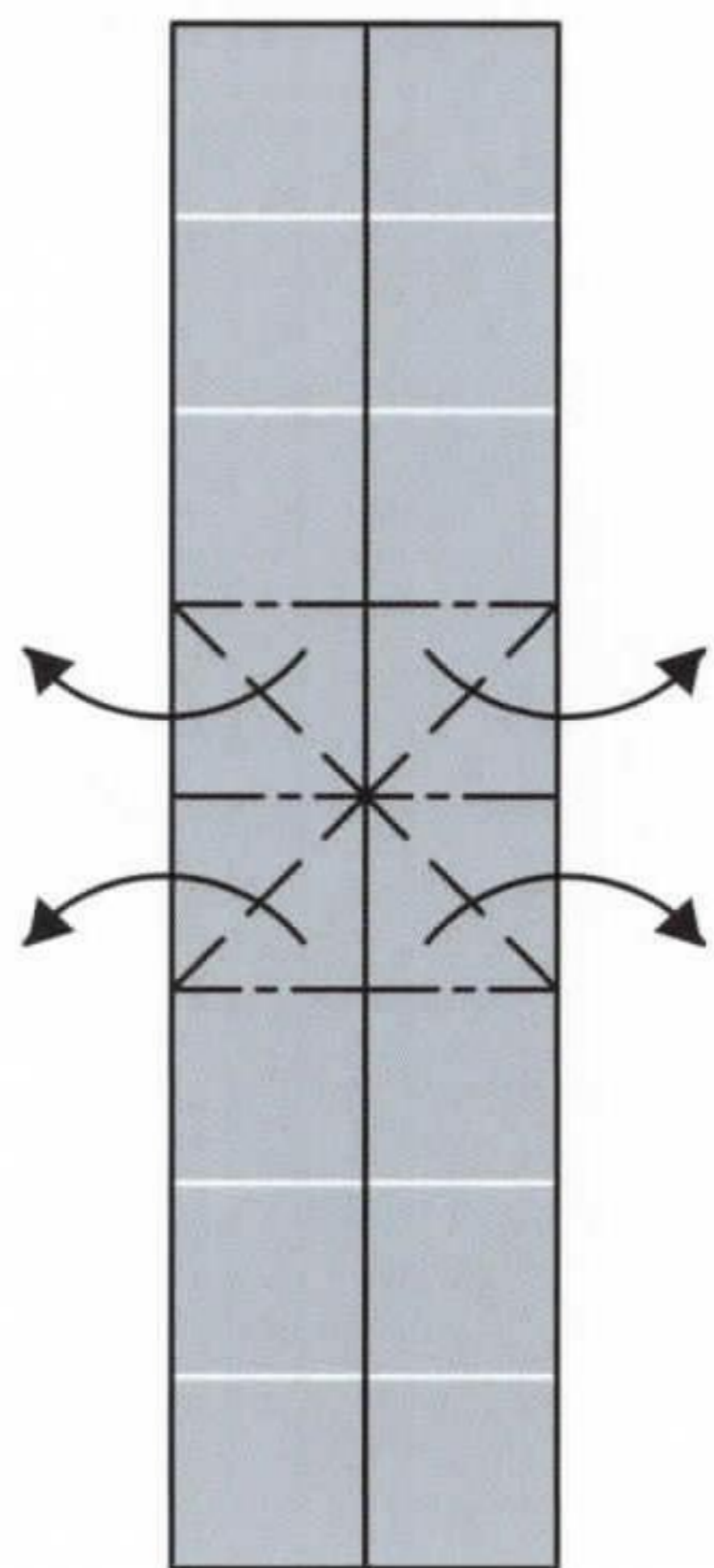

13. Crimp folds

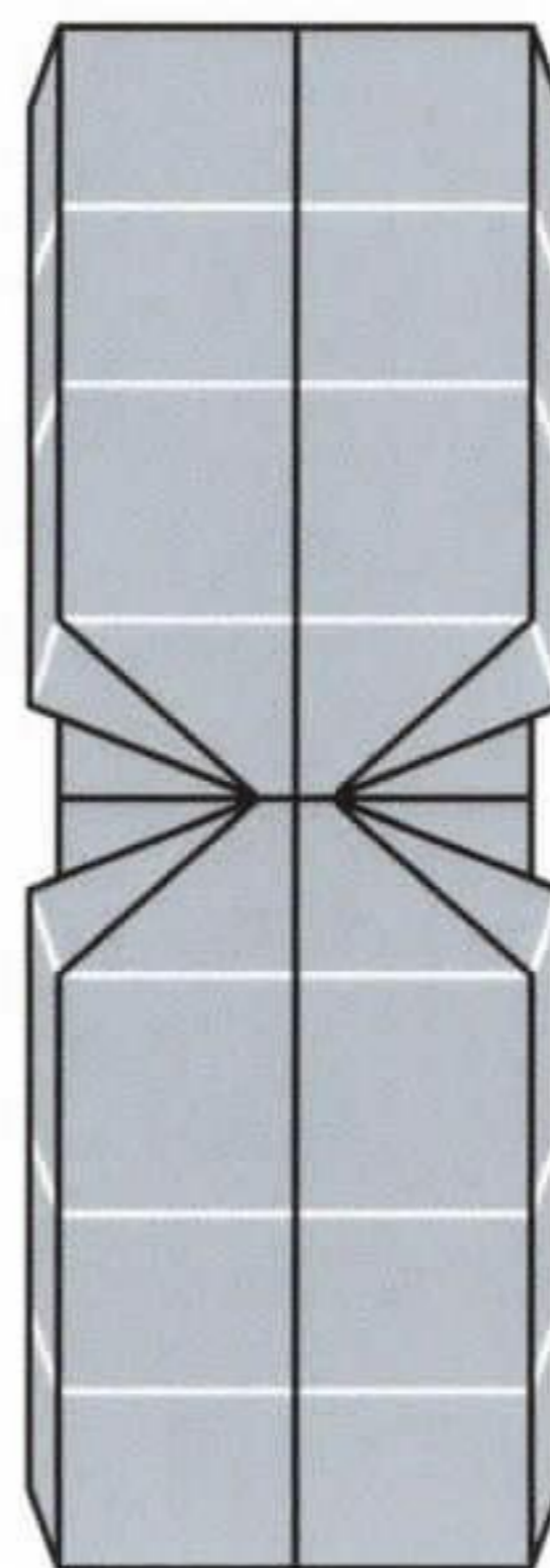

14. Before complete

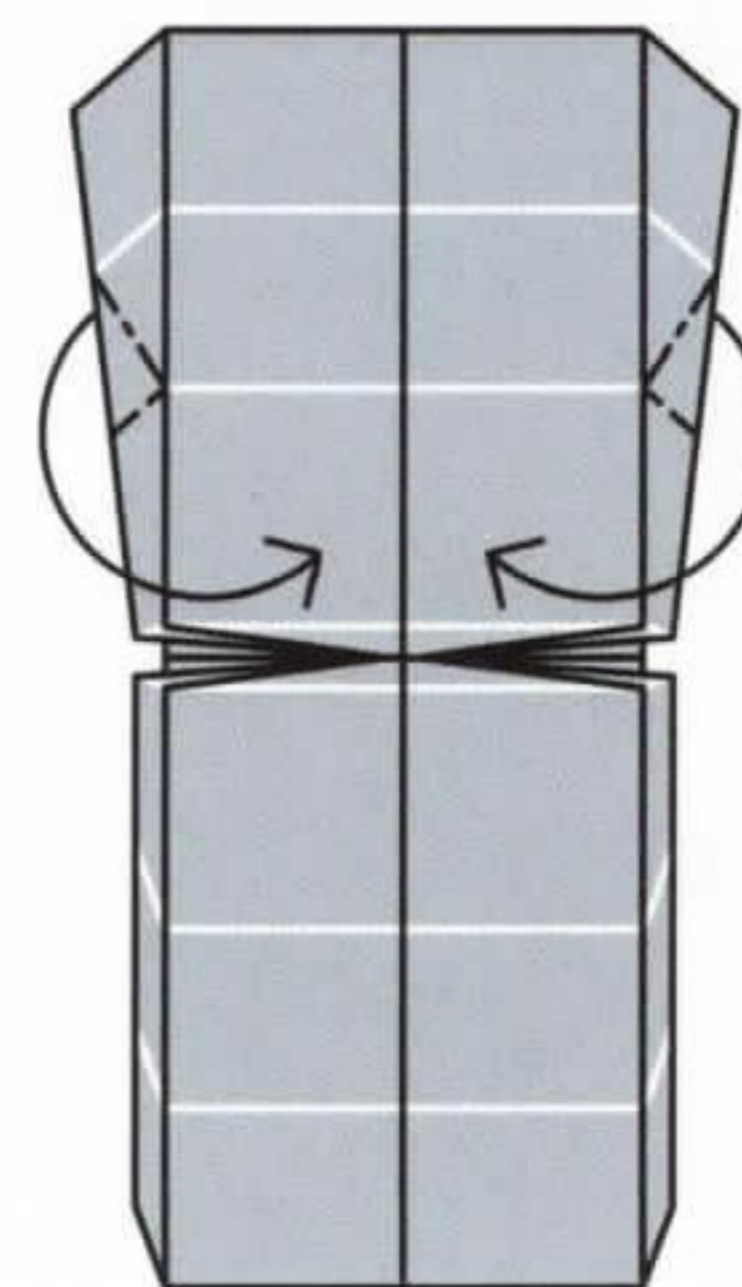

15. Crimp folds

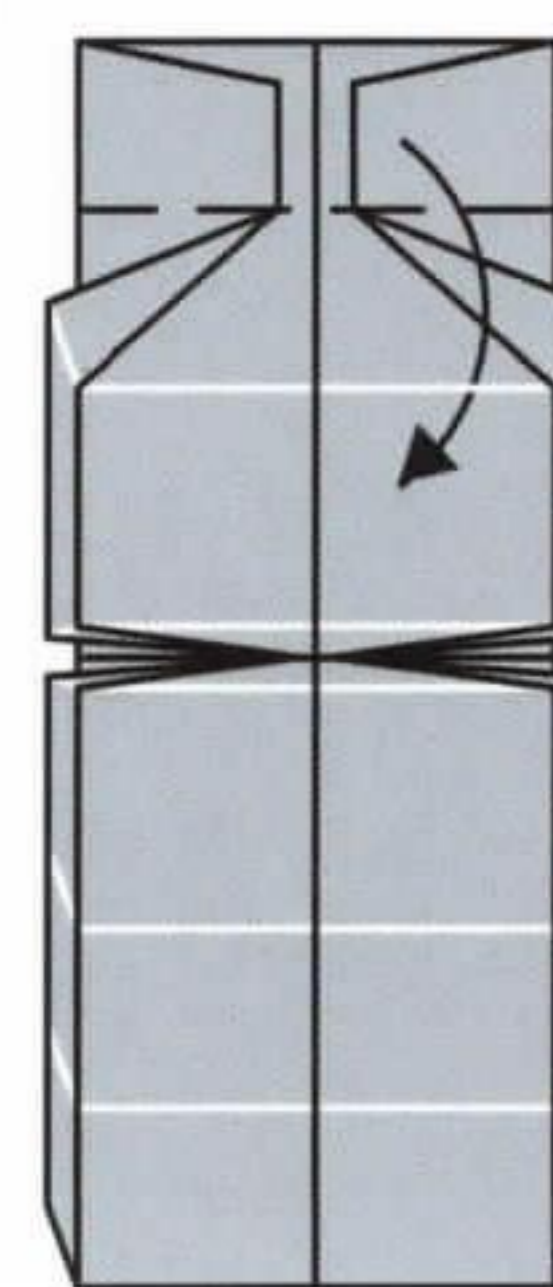

16. Valley fold

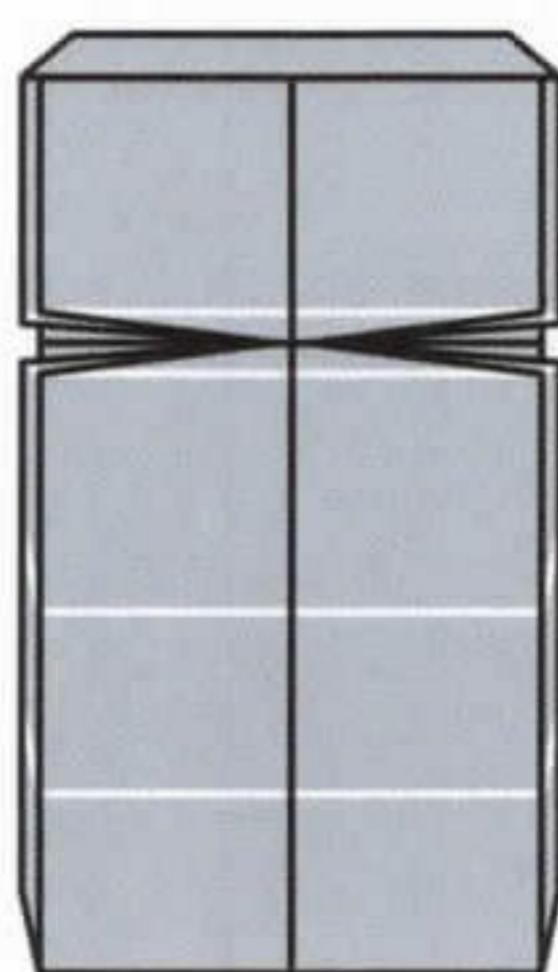

17. Turn over

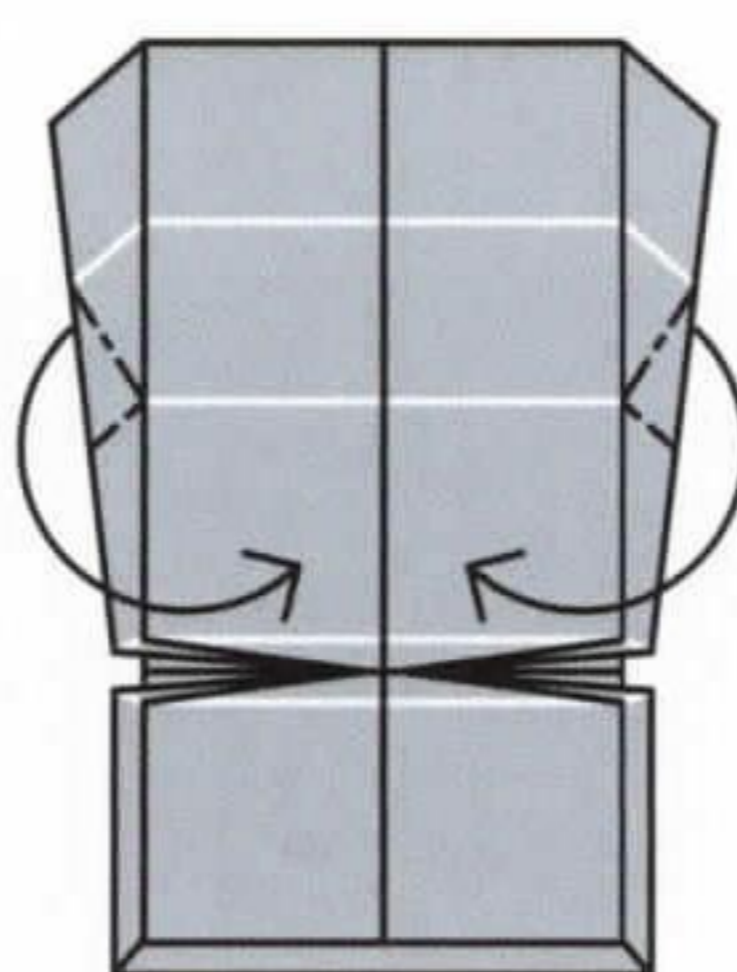

18. Crimp folds

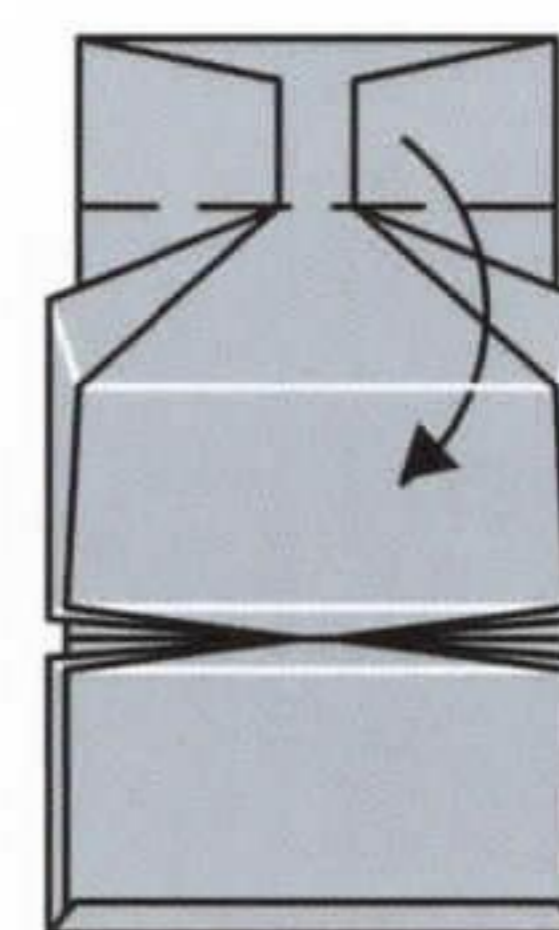

19. Valley fold

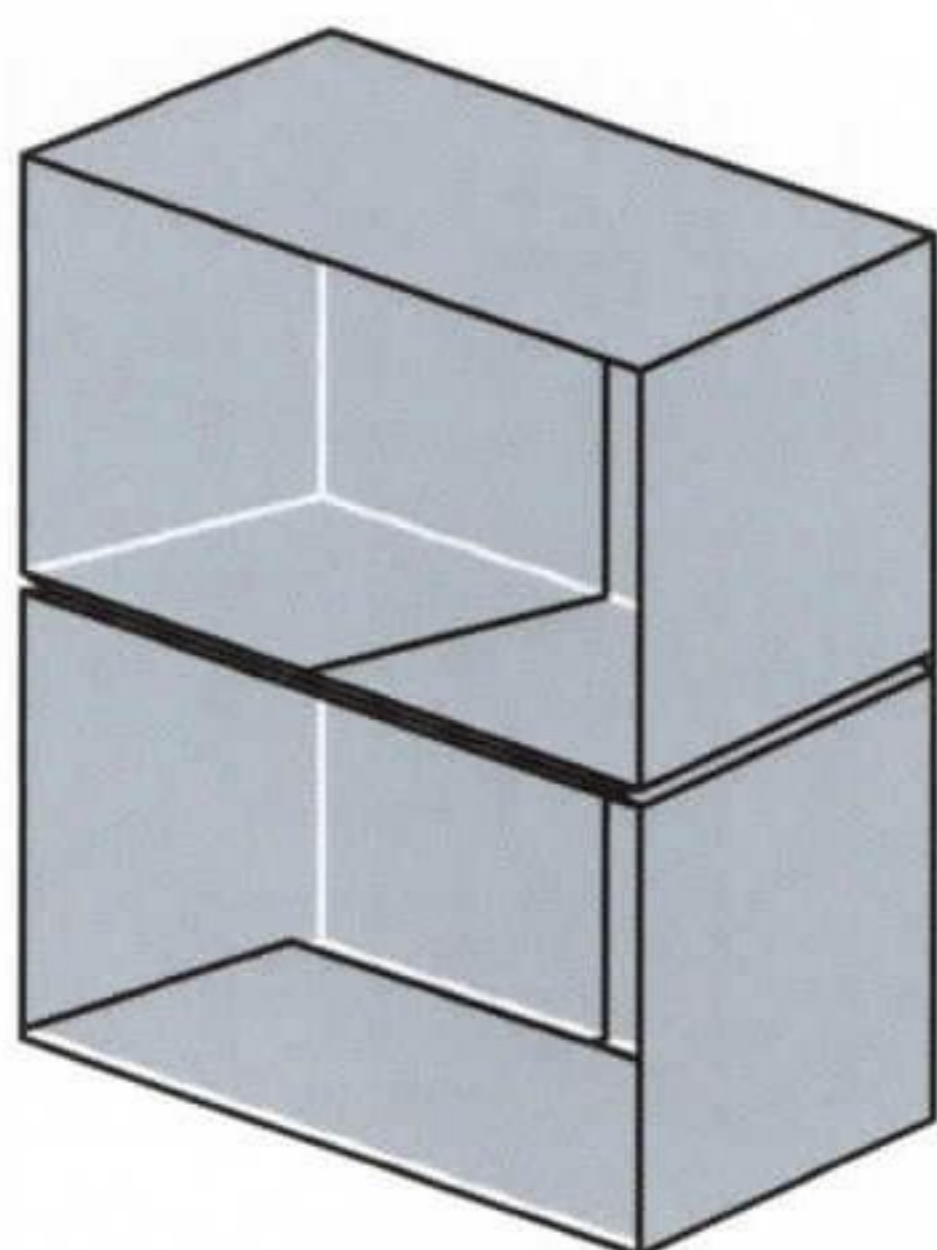

20. Completed PART 1

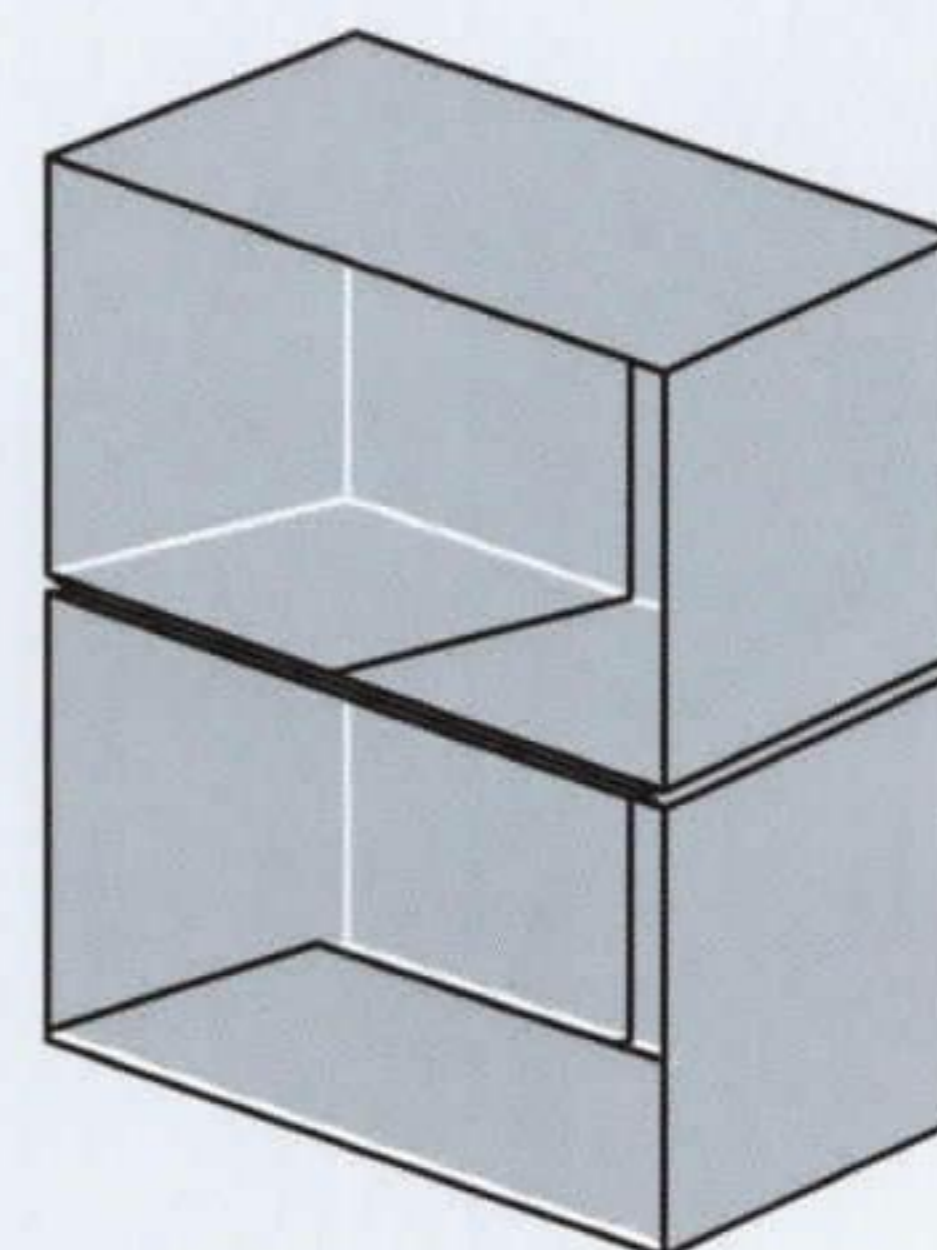

NOTE: Make another PART 1 for the following assembly

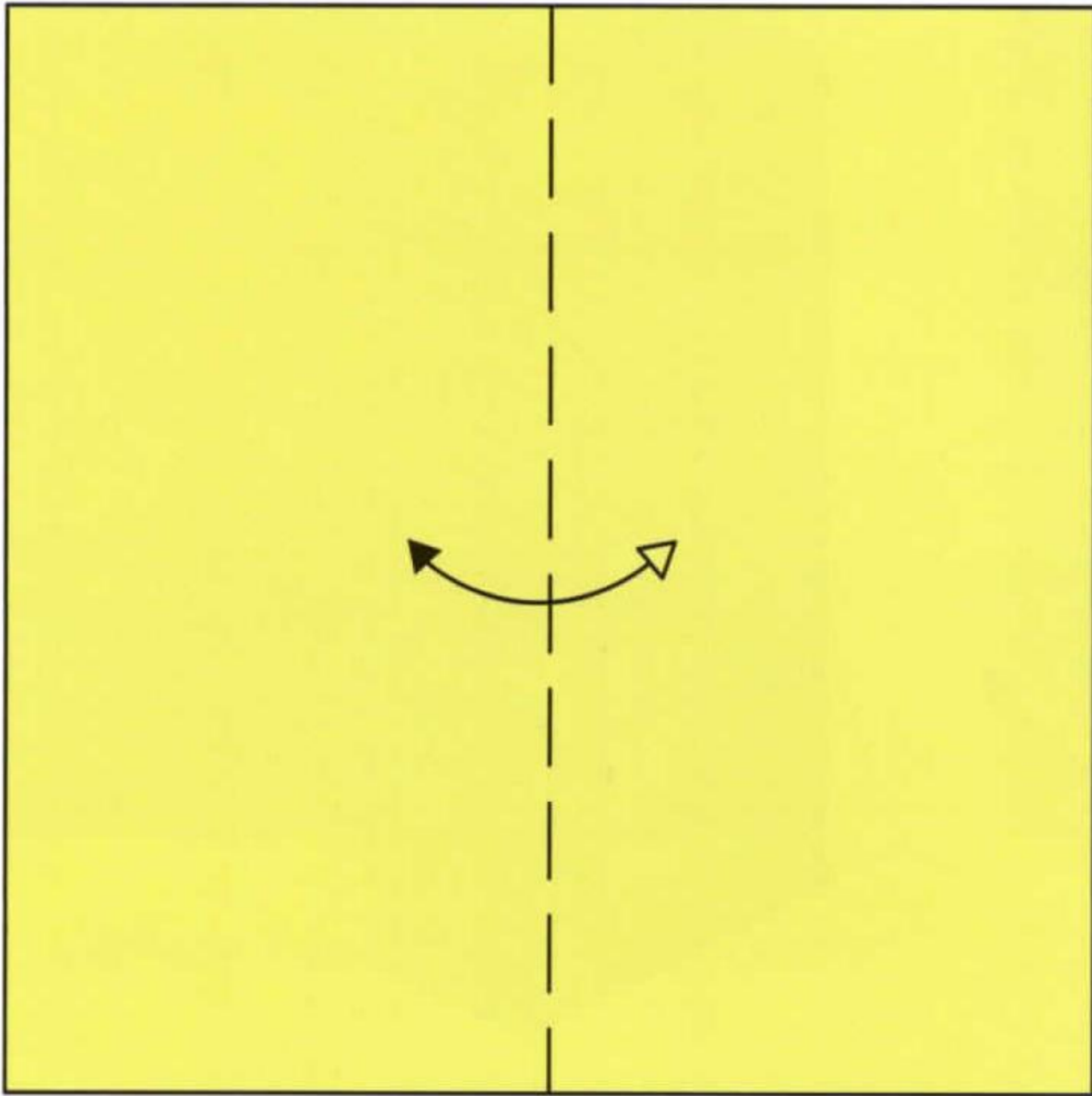

1. Valley fold and unfold

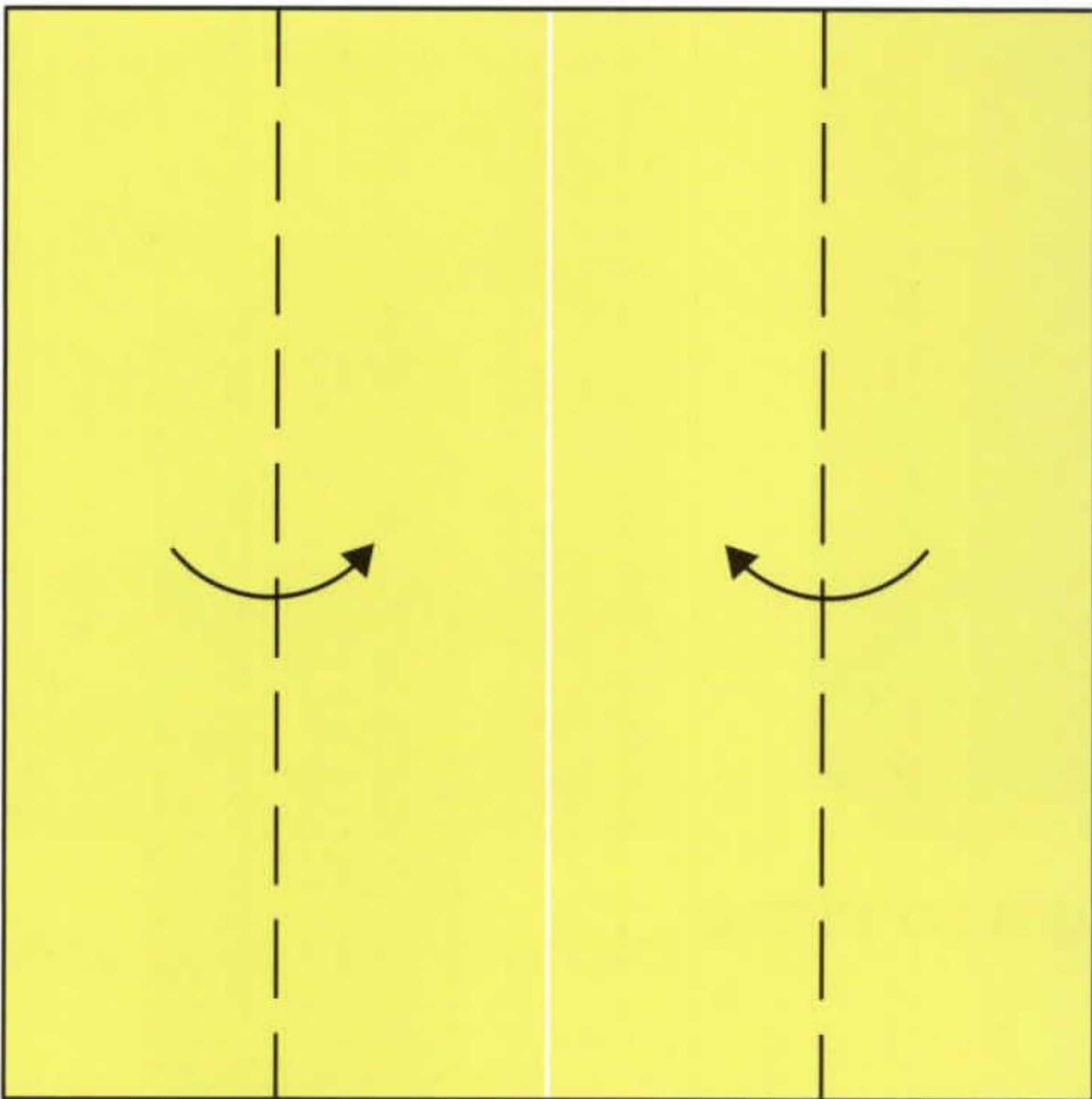

2. Valley folds

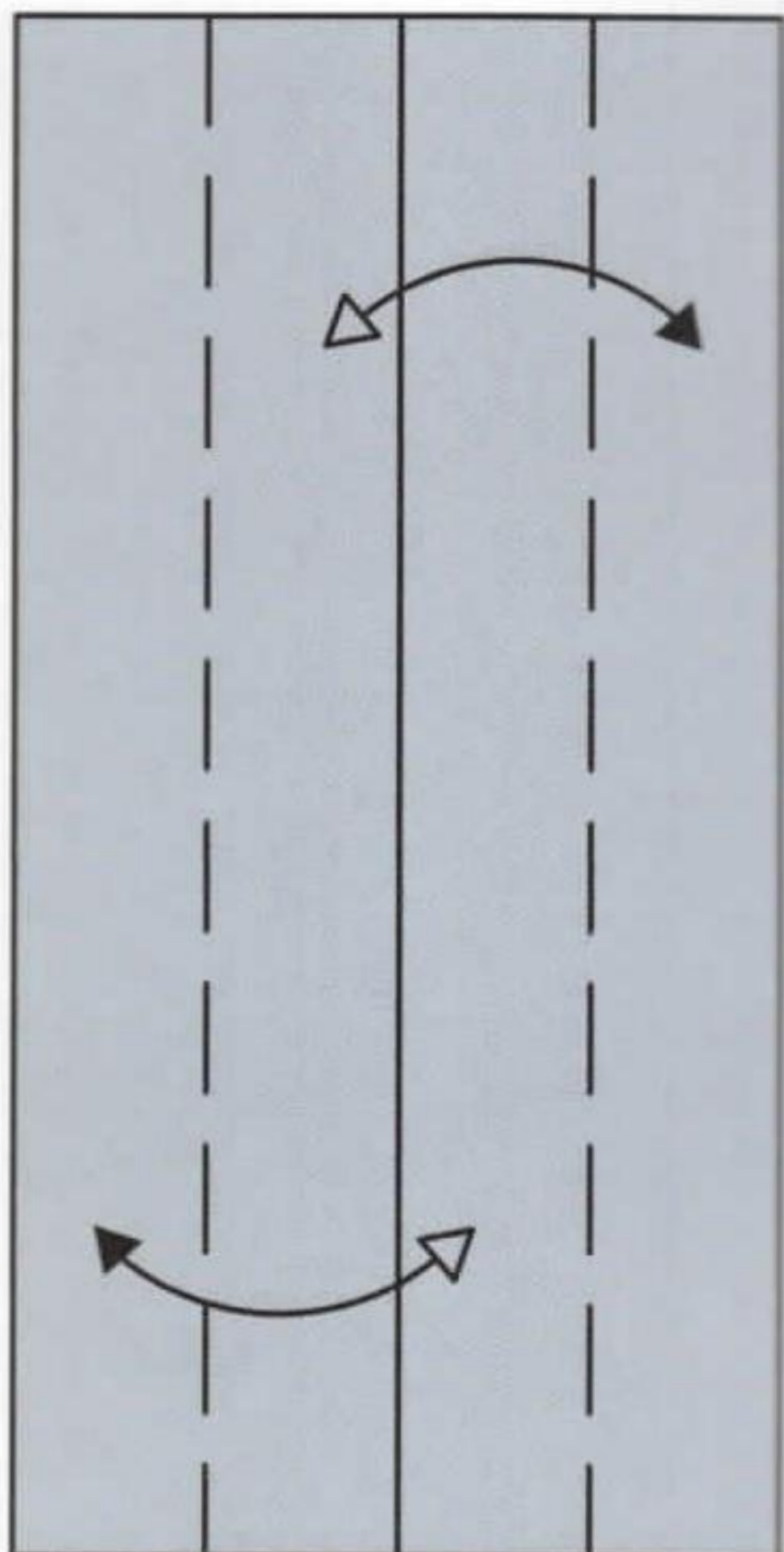

3. Valley folds

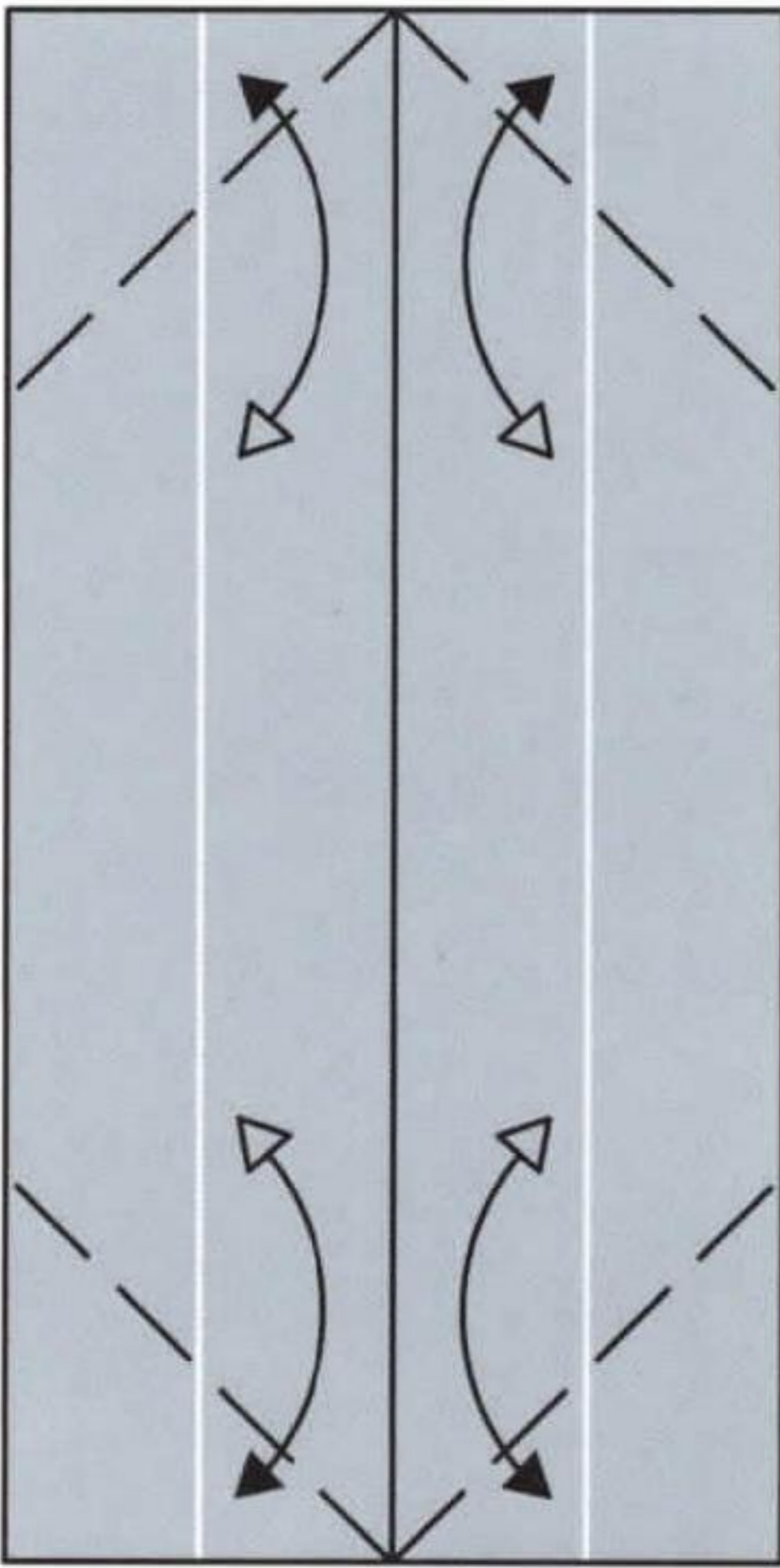

4. Valley folds and unfold

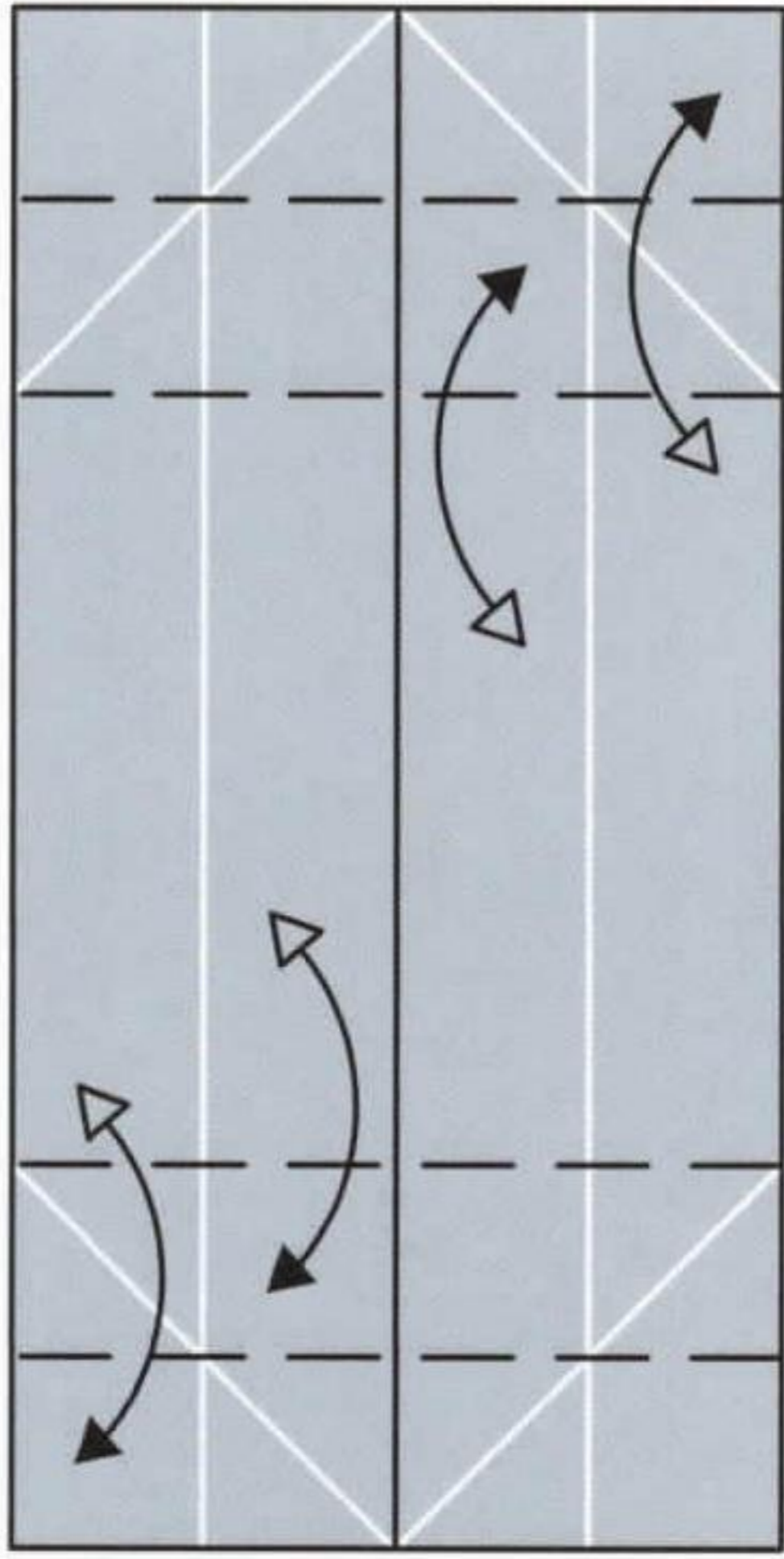

5. Repeat

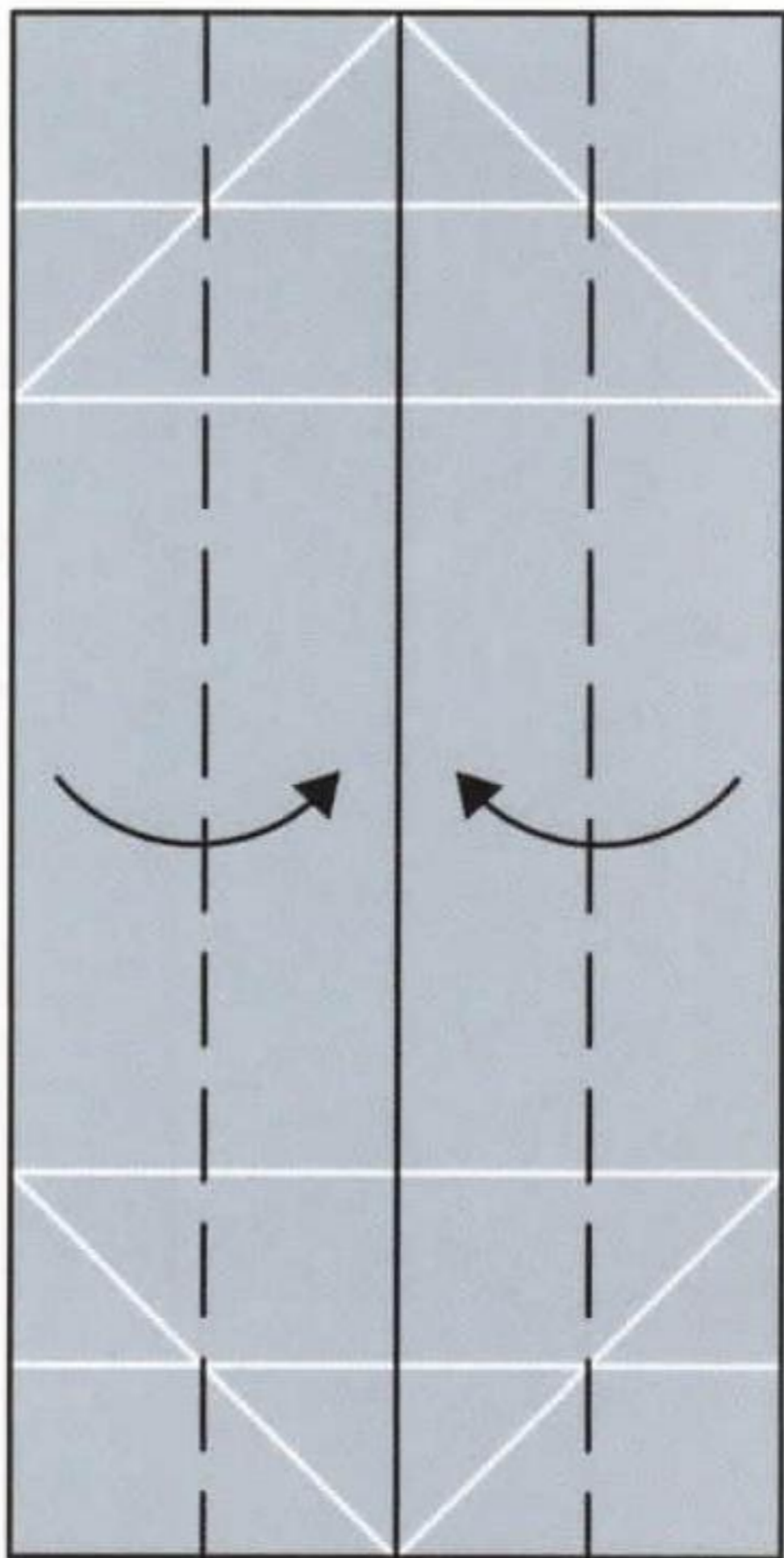

6. Valley folds

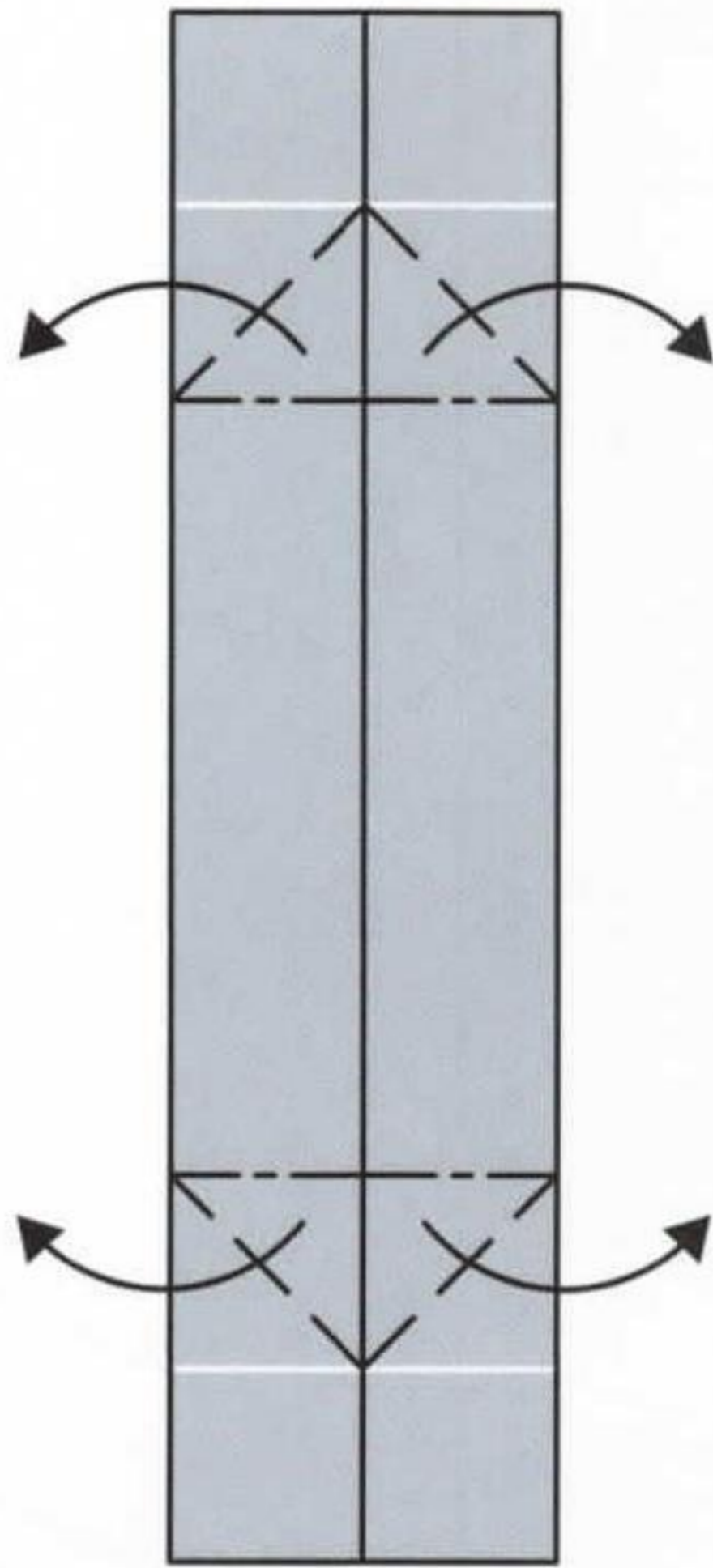

7. Squash folds

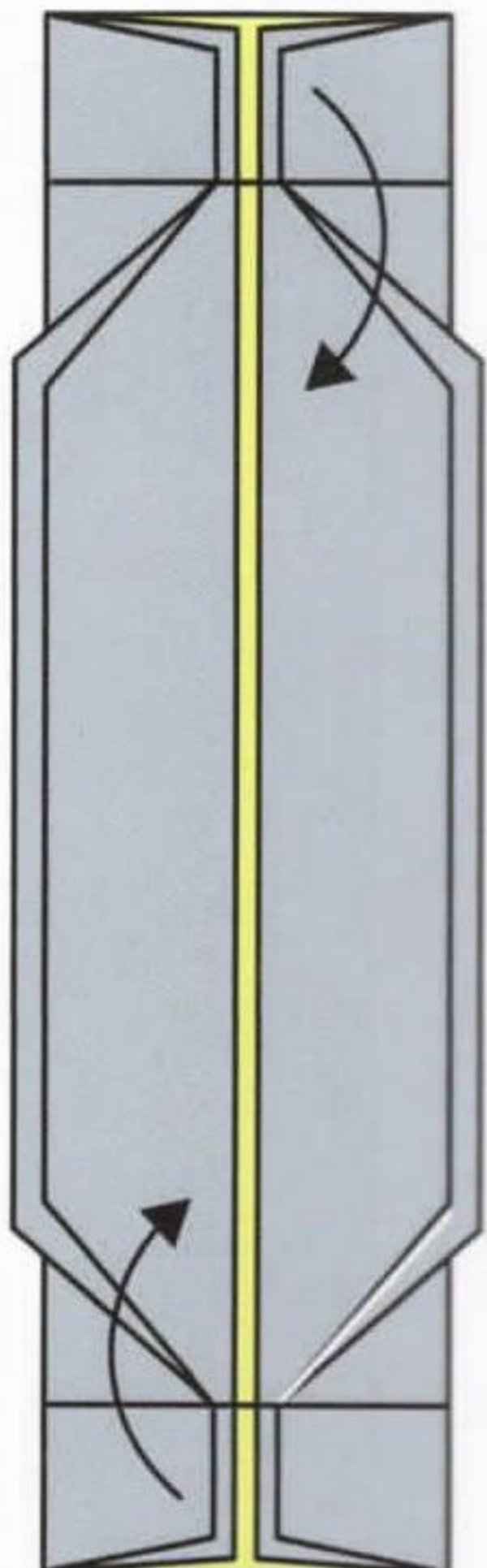

8. Tuck the sides in with valley folds

dresser: part 2

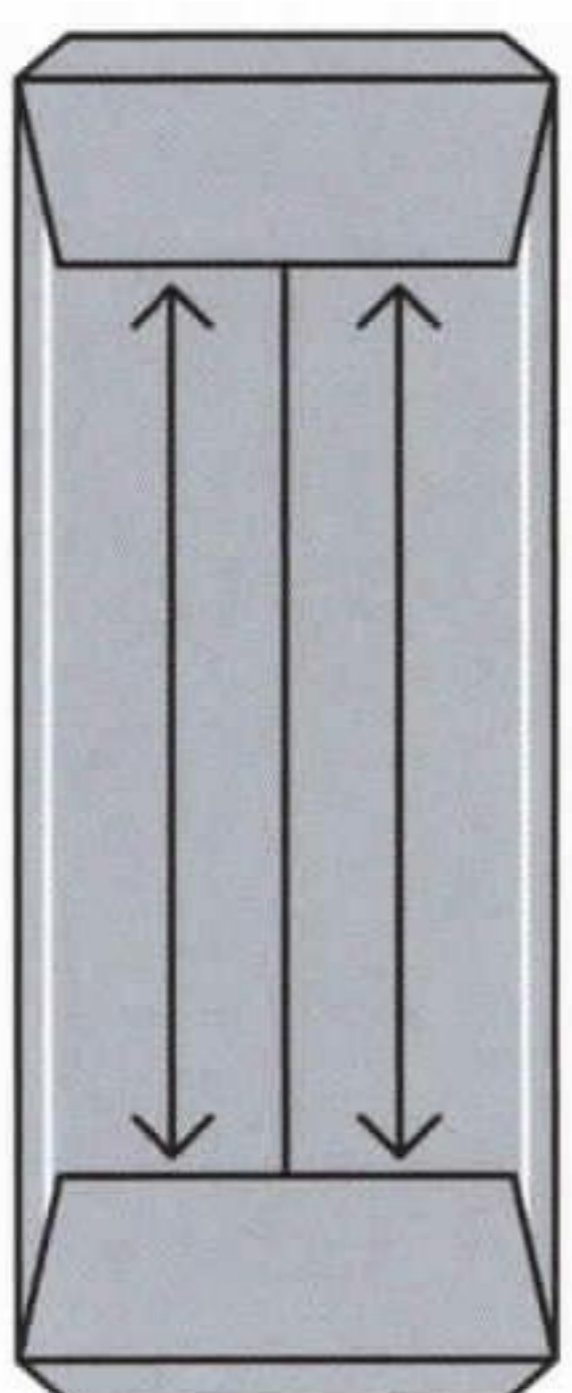

9. Push to close

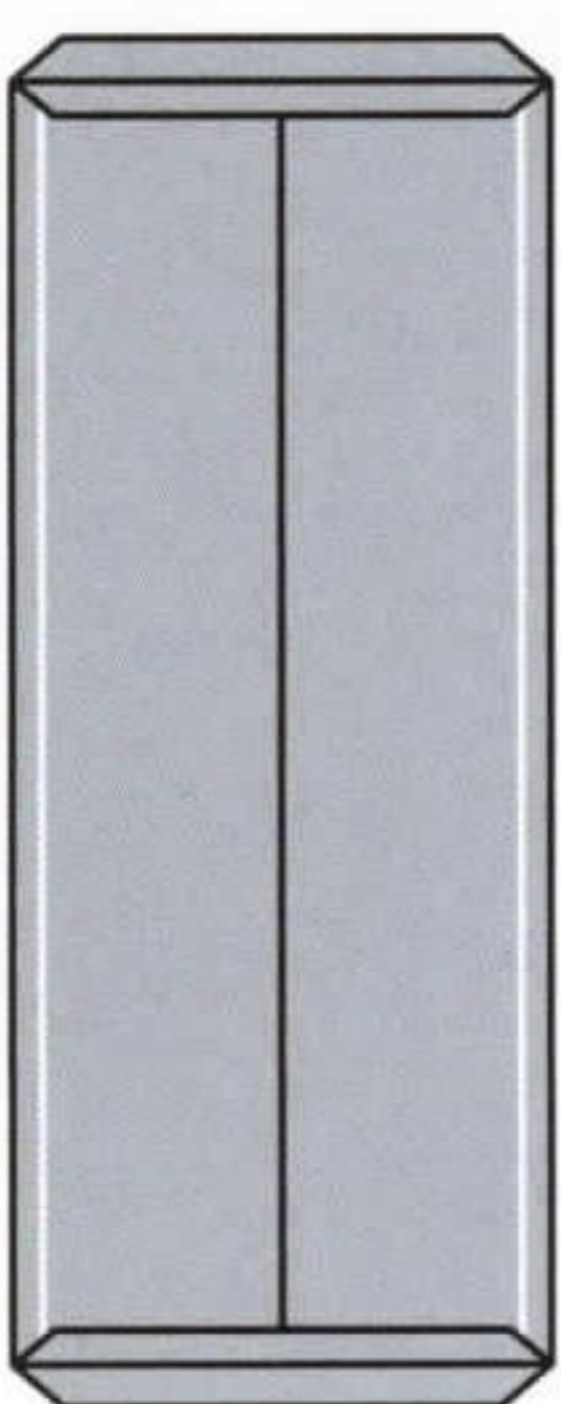

10. Rotate

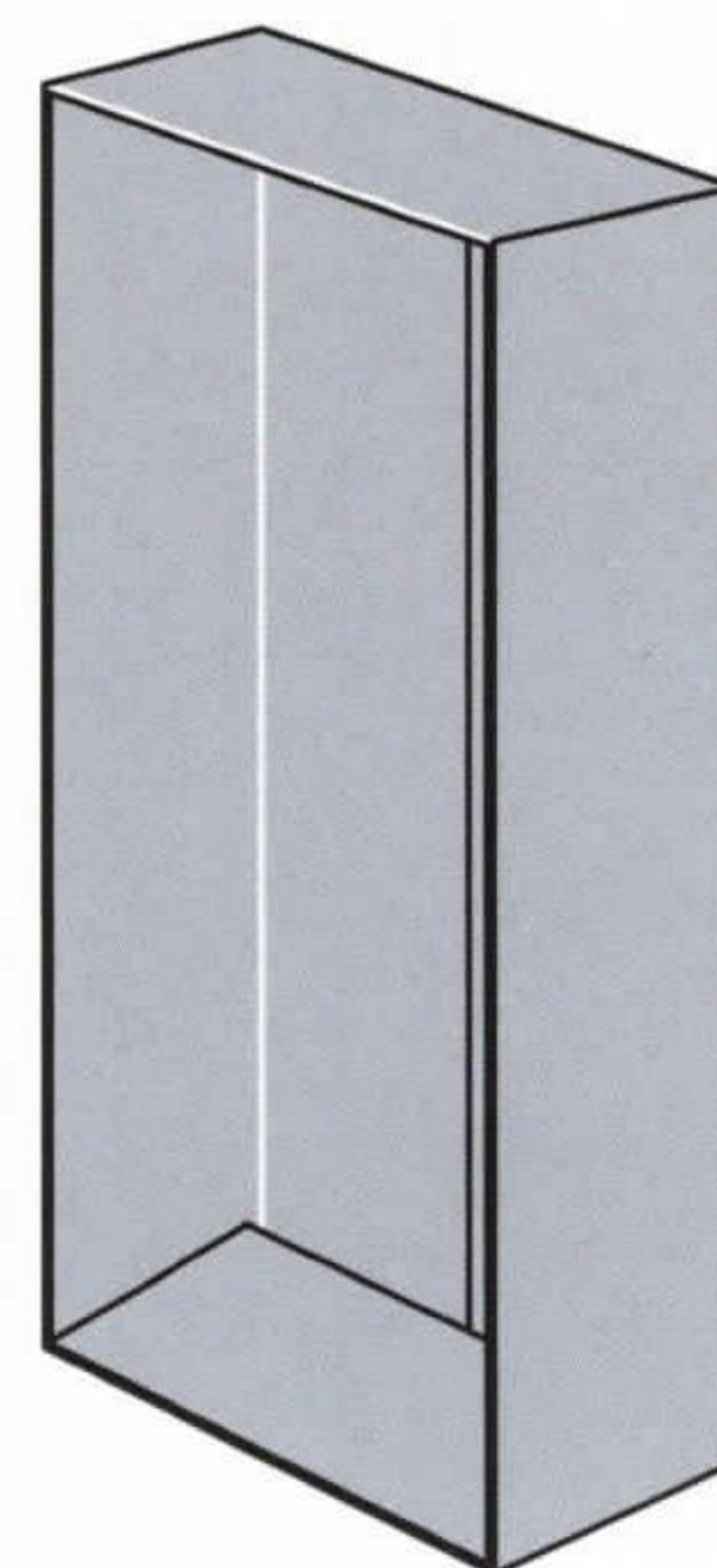

11. Completed PART 2

FIRST ASSEMBLY

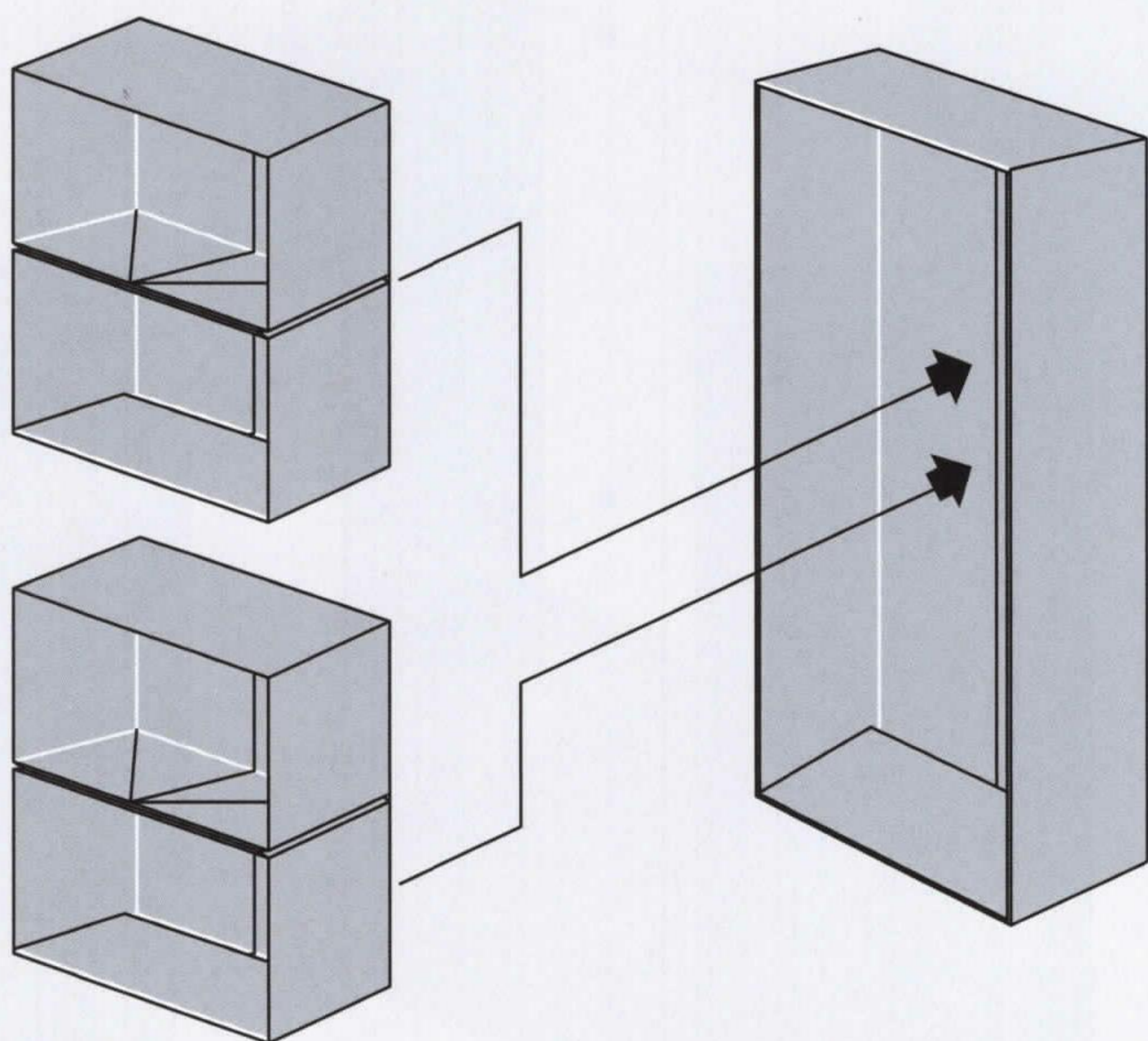

1. Insert as indicated by the arrows and apply glue

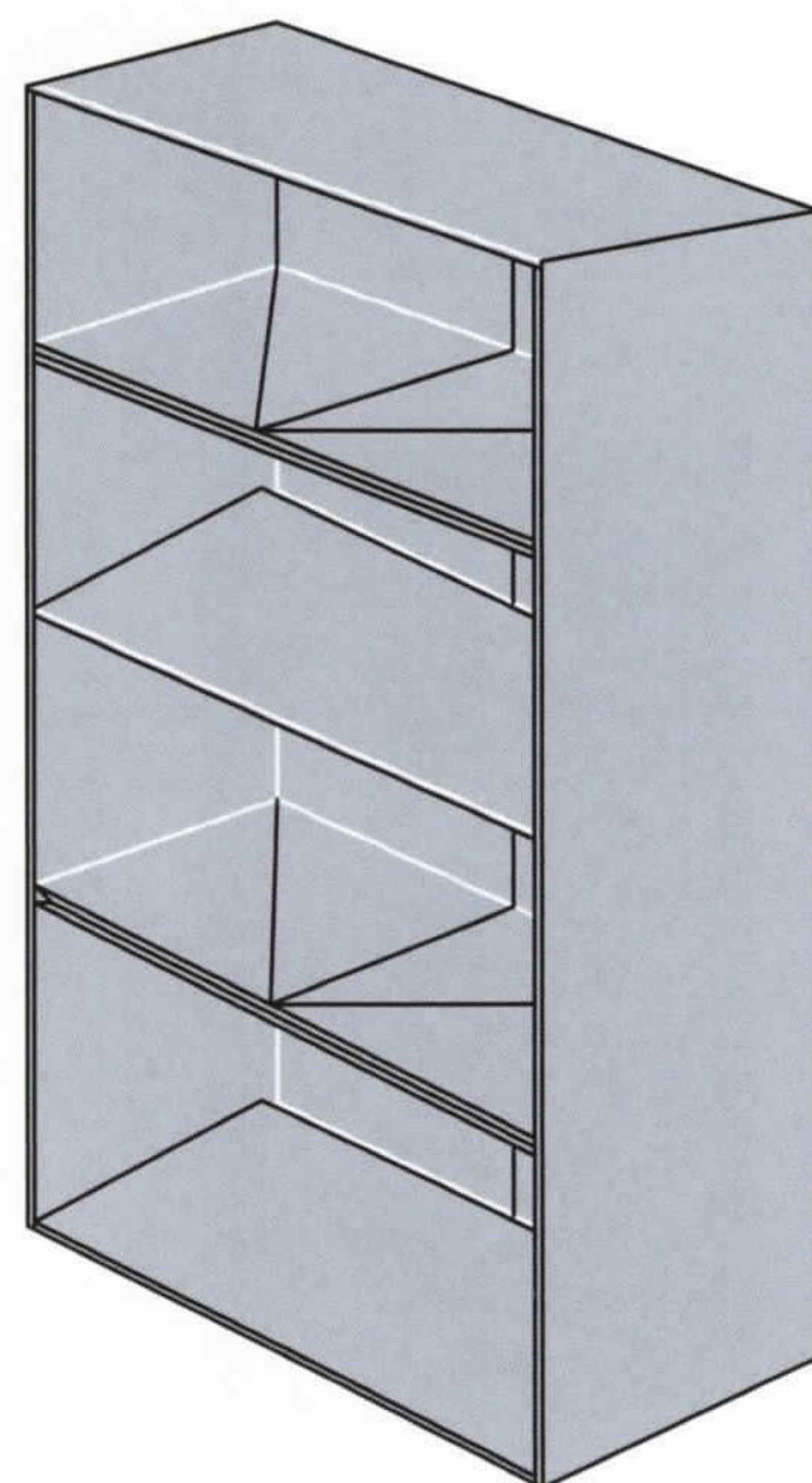

2. Completed FIRST ASSEMBLY

dresser: part 3

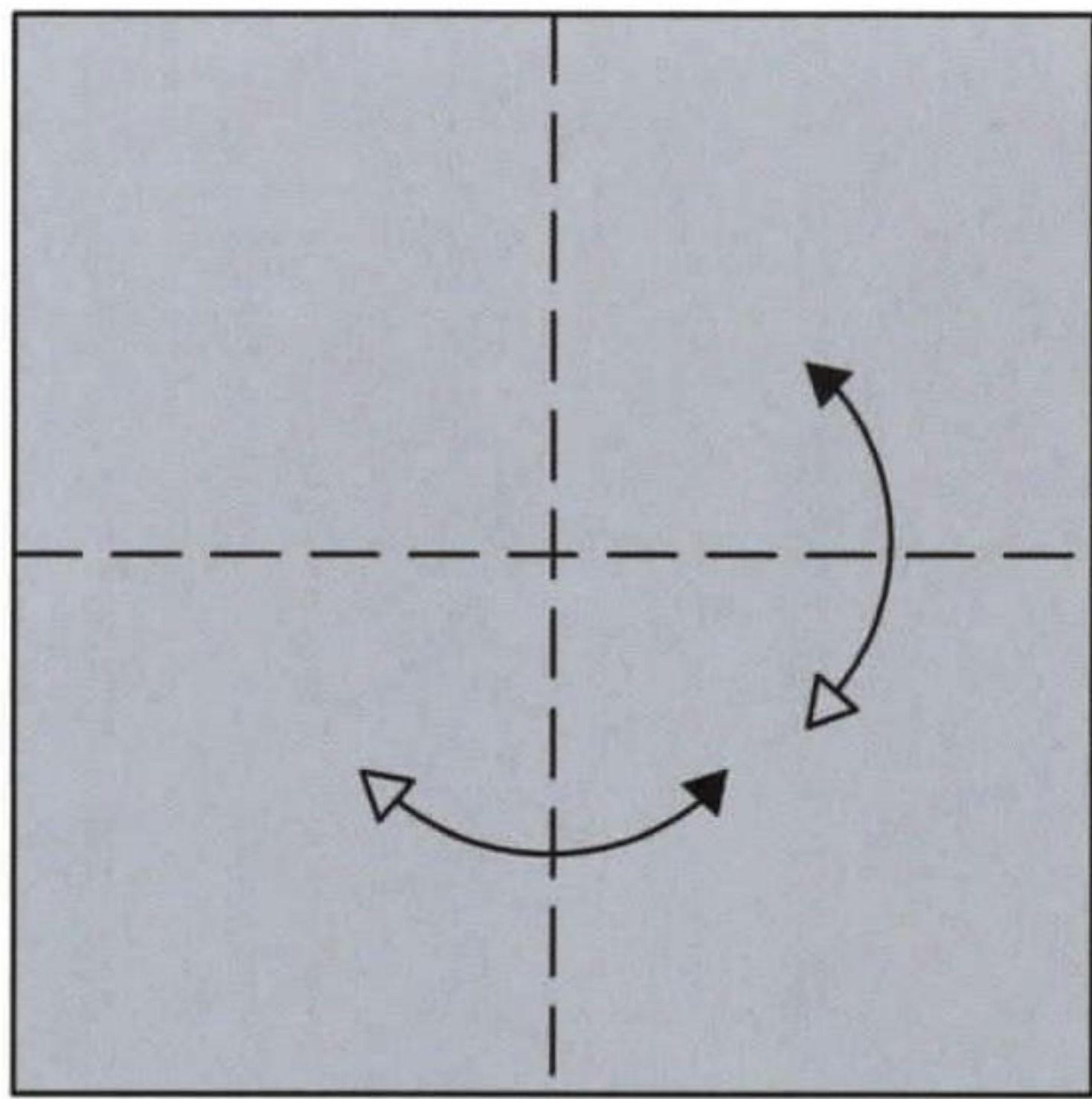

1. Valley folds and unfold

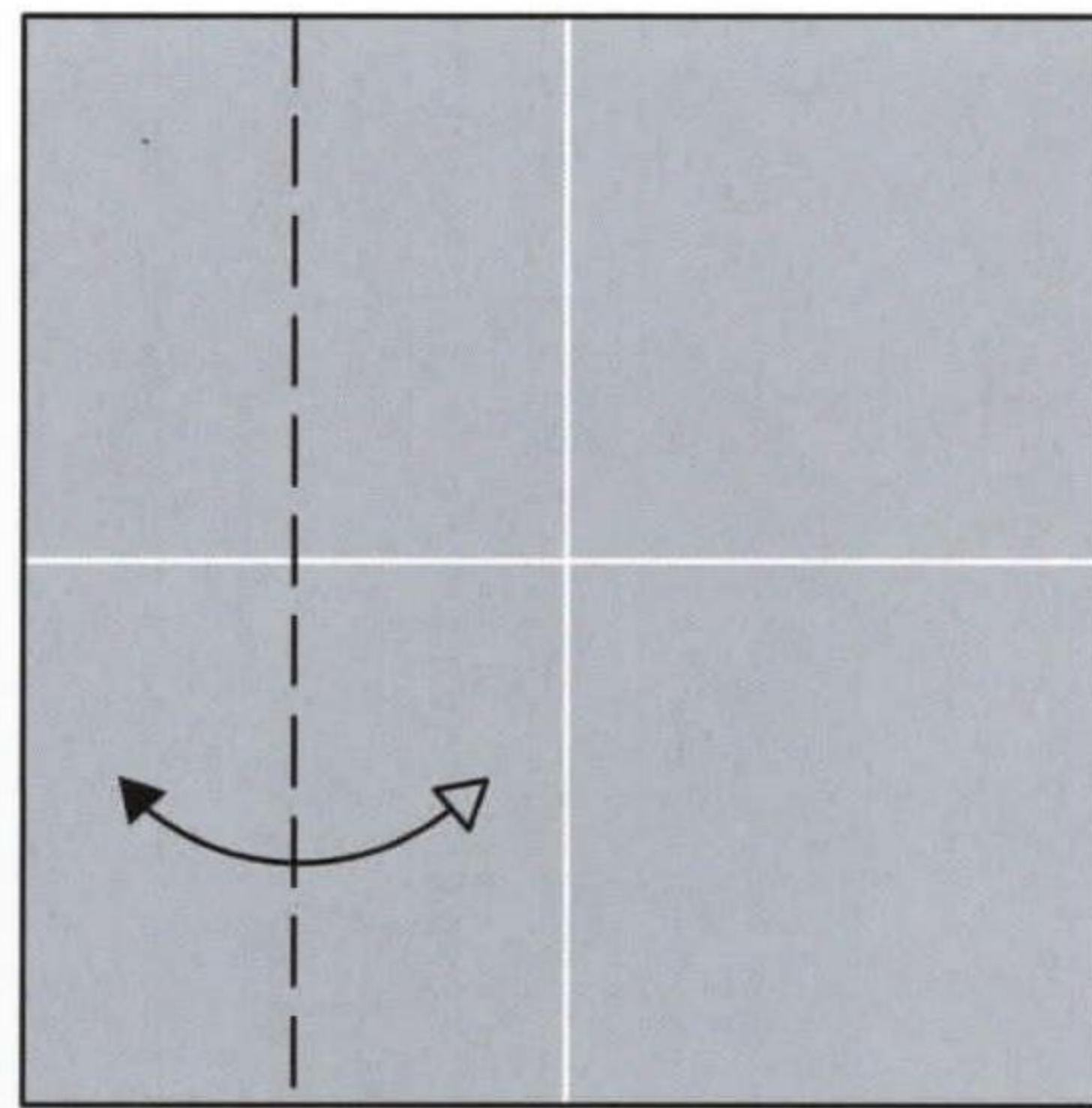

2. Valley fold and unfold

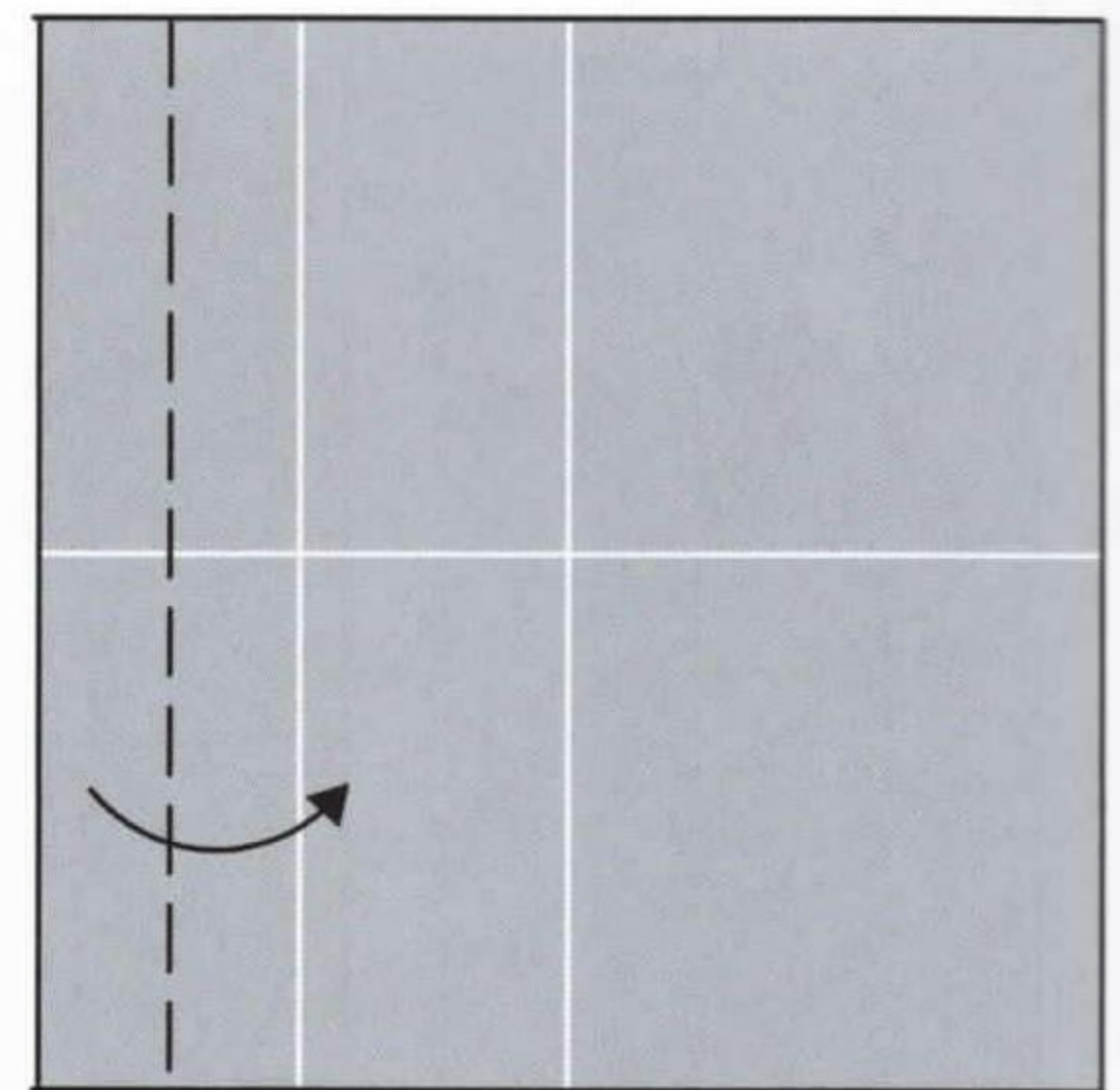

3. Valley fold

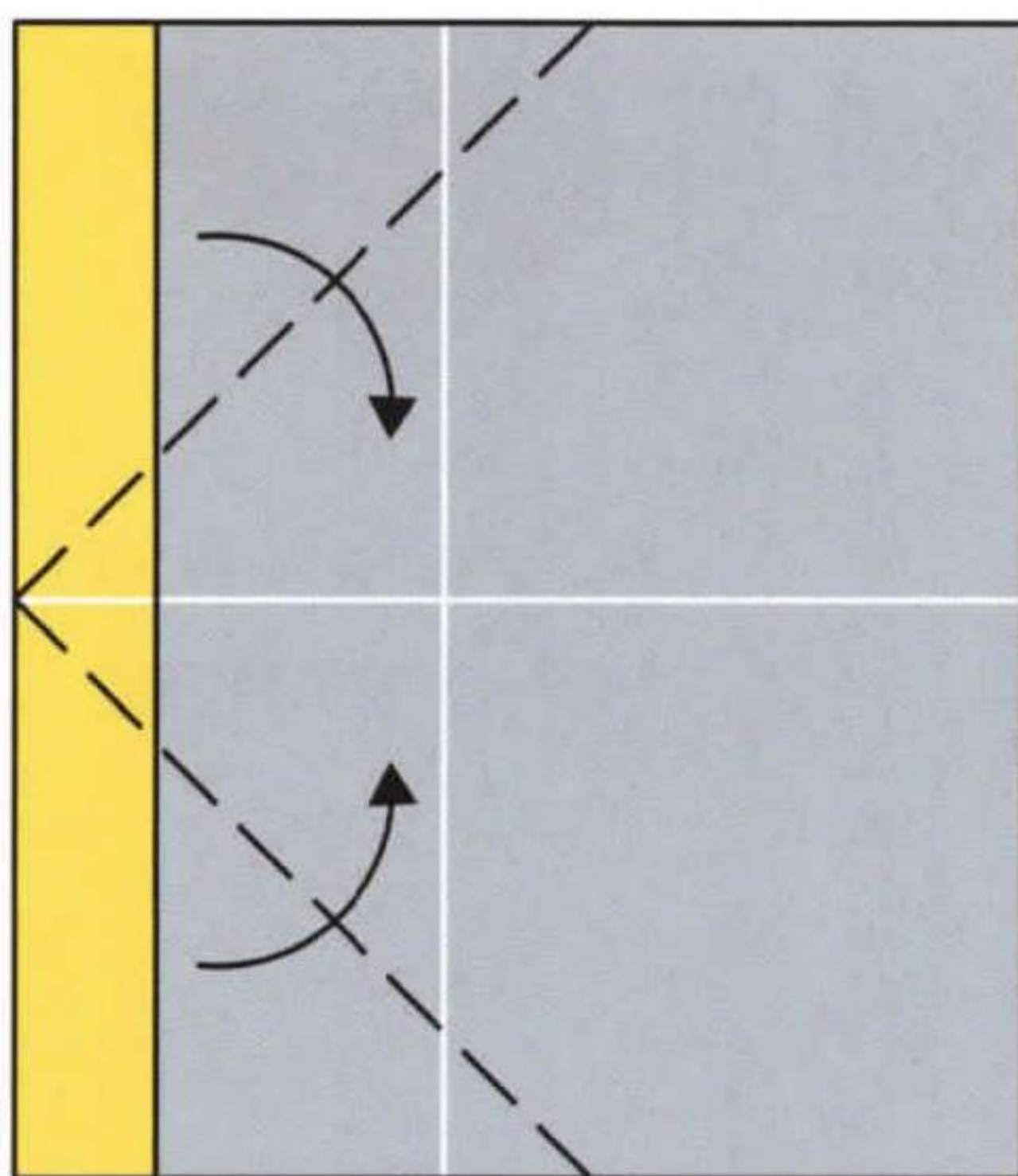

4. Valley folds

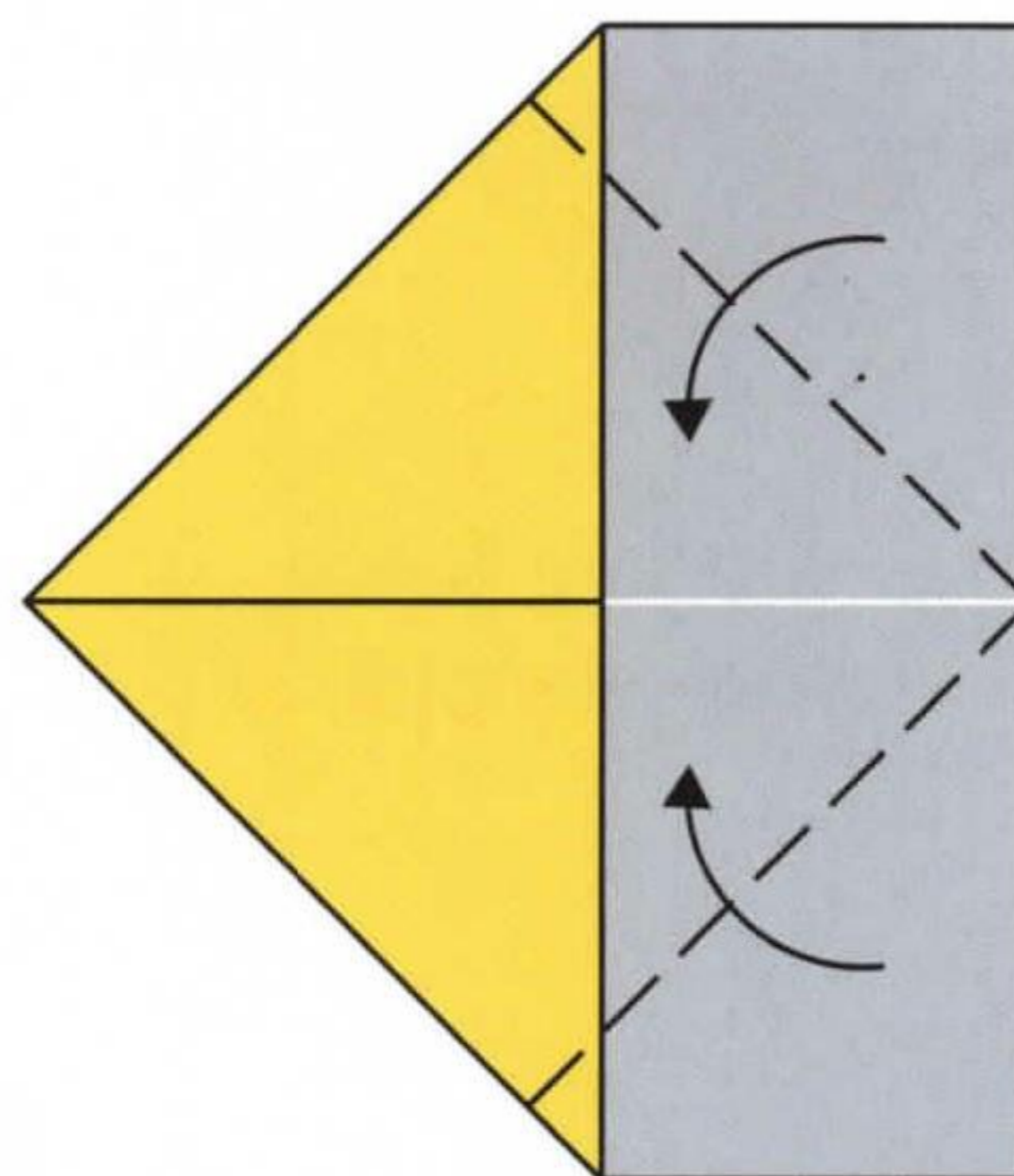

5. Valley folds

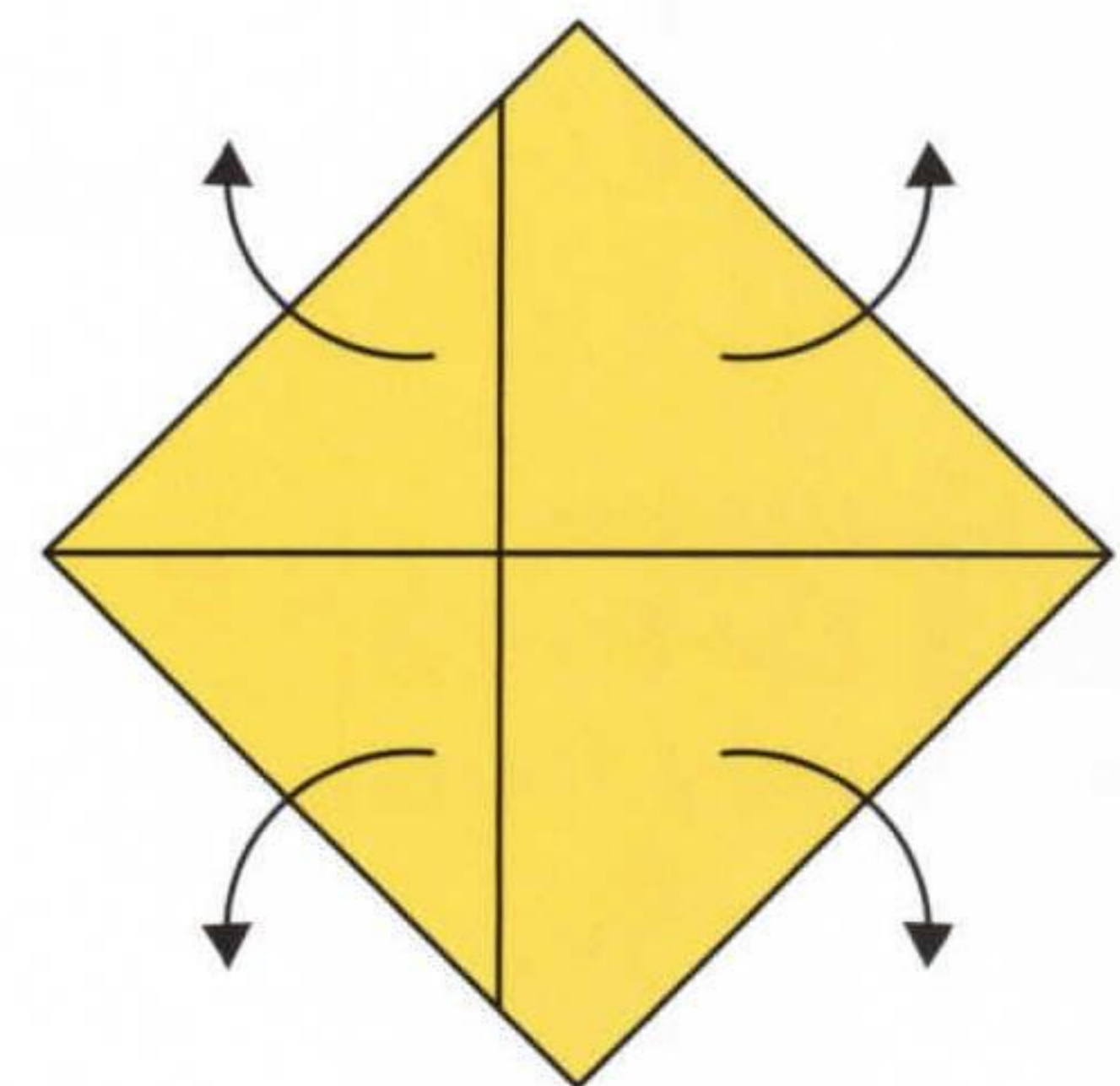

6. Valley folds to unfold

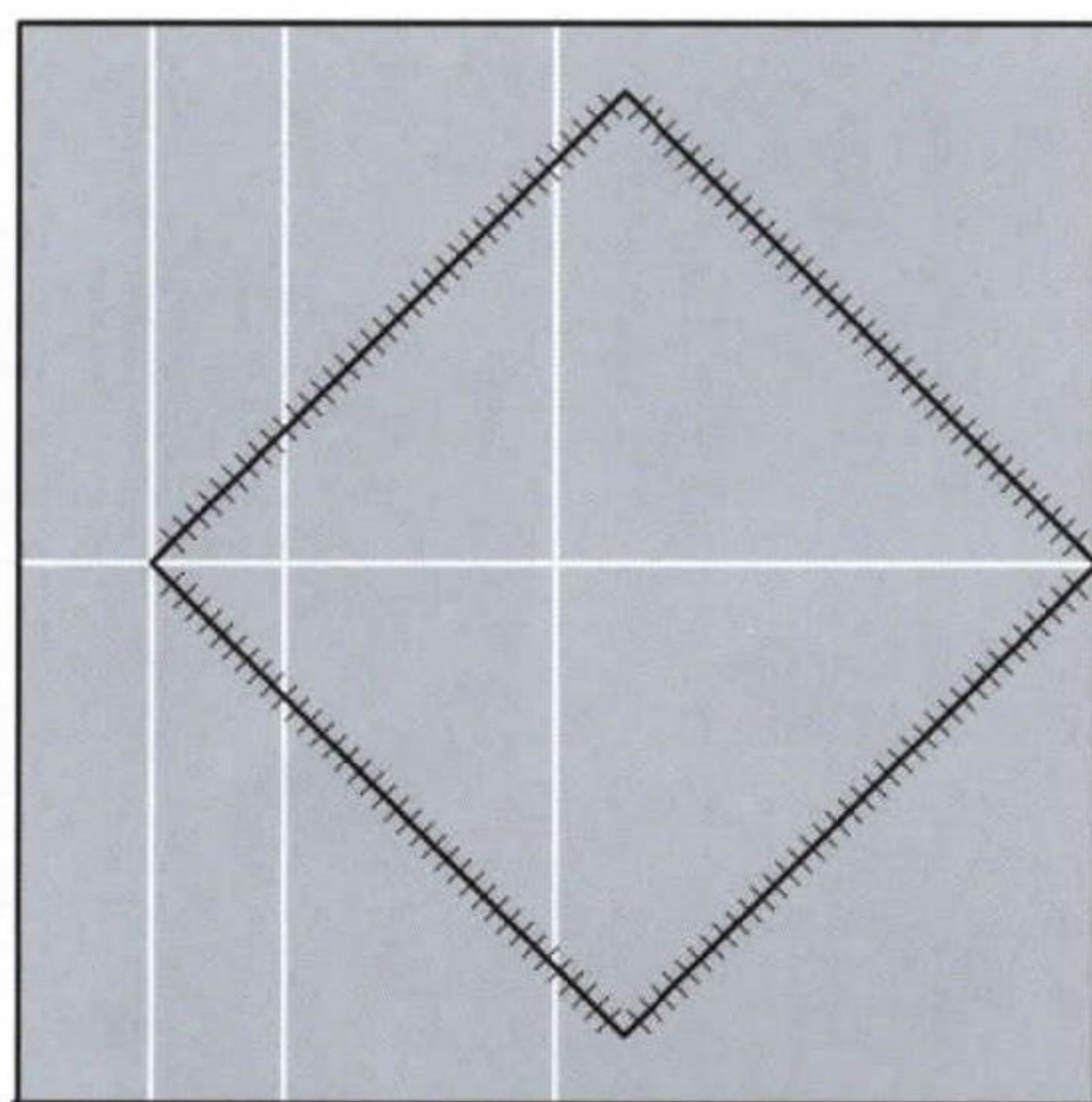

7. Cut out the indicated section

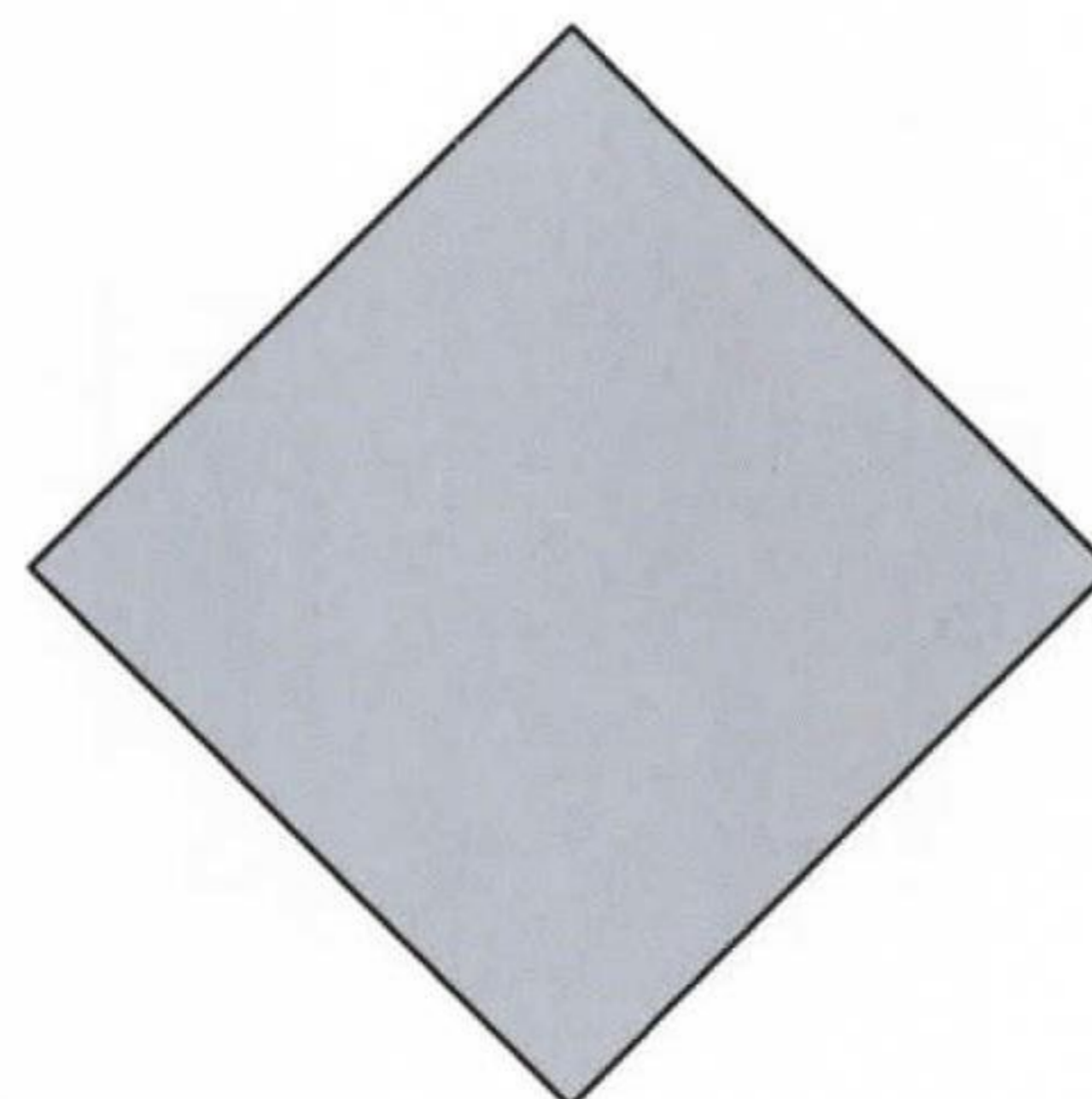

8. Completed PART 3

NOTE:
Cut three
more to use
for Part 3
of Dresser

dresser: part 4

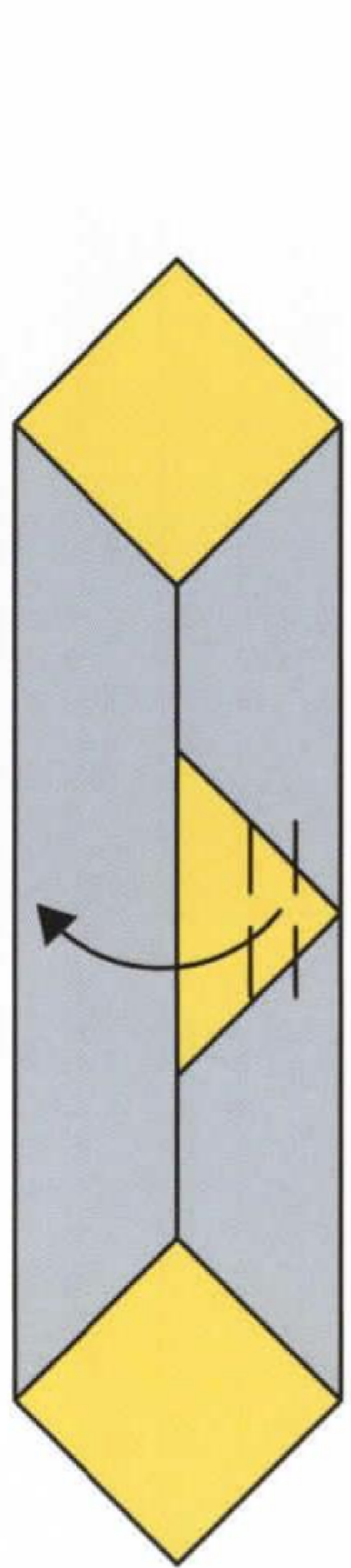

1. Complete Steps 1-7 in Part 3, then Valley folds

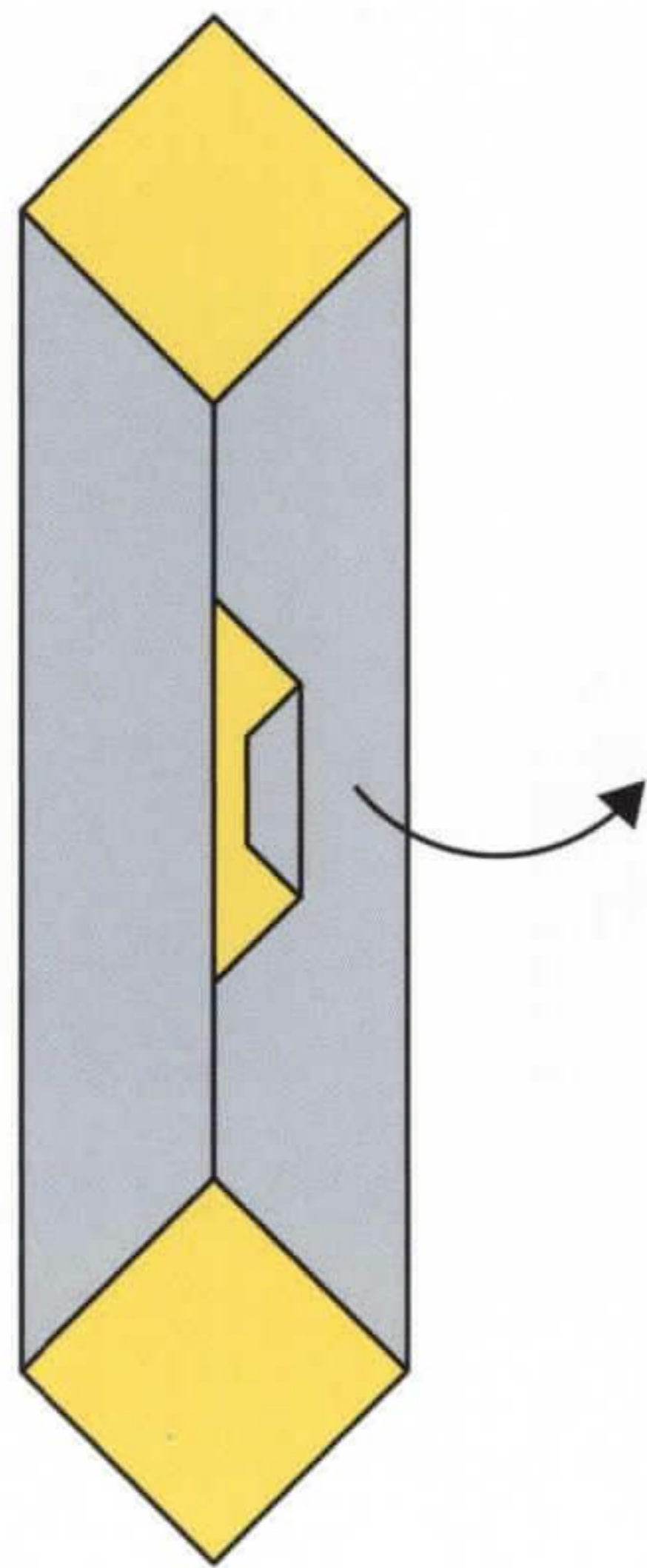

2. Valley fold

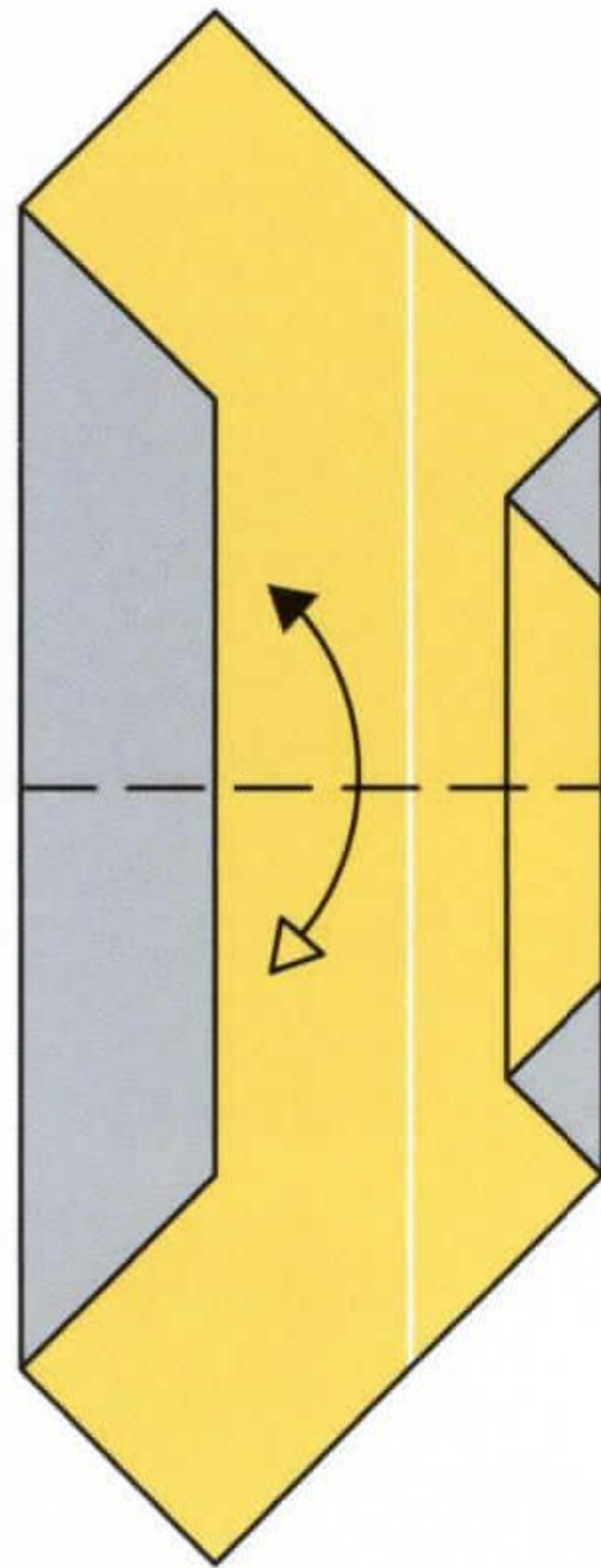

3. Valley fold and unfold

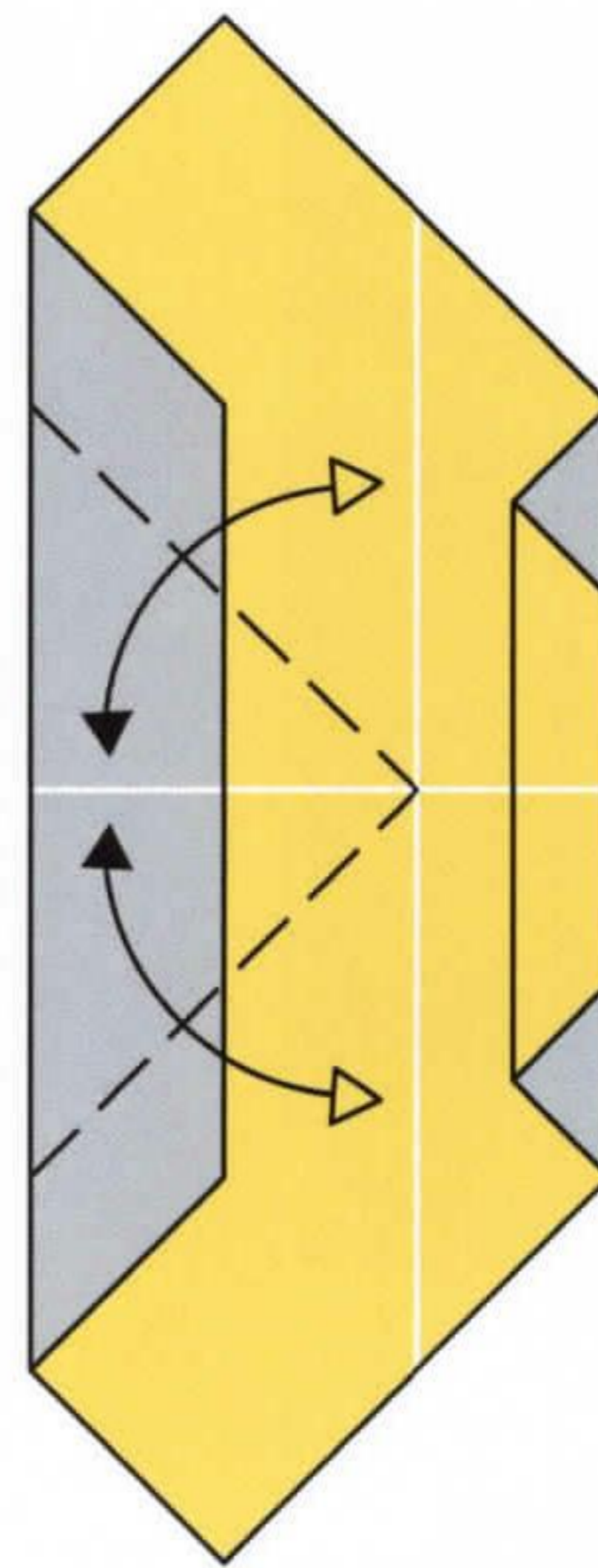

4. Repeat

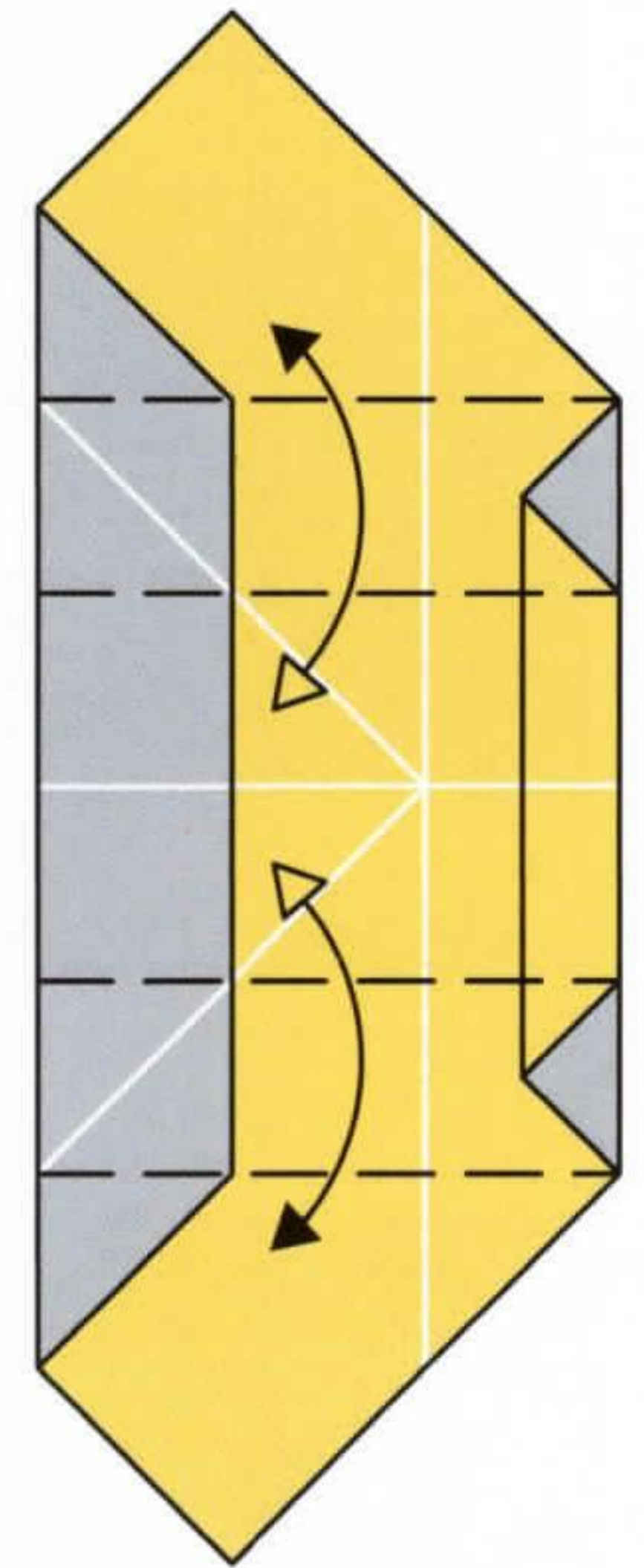

5. Valley fold and unfold

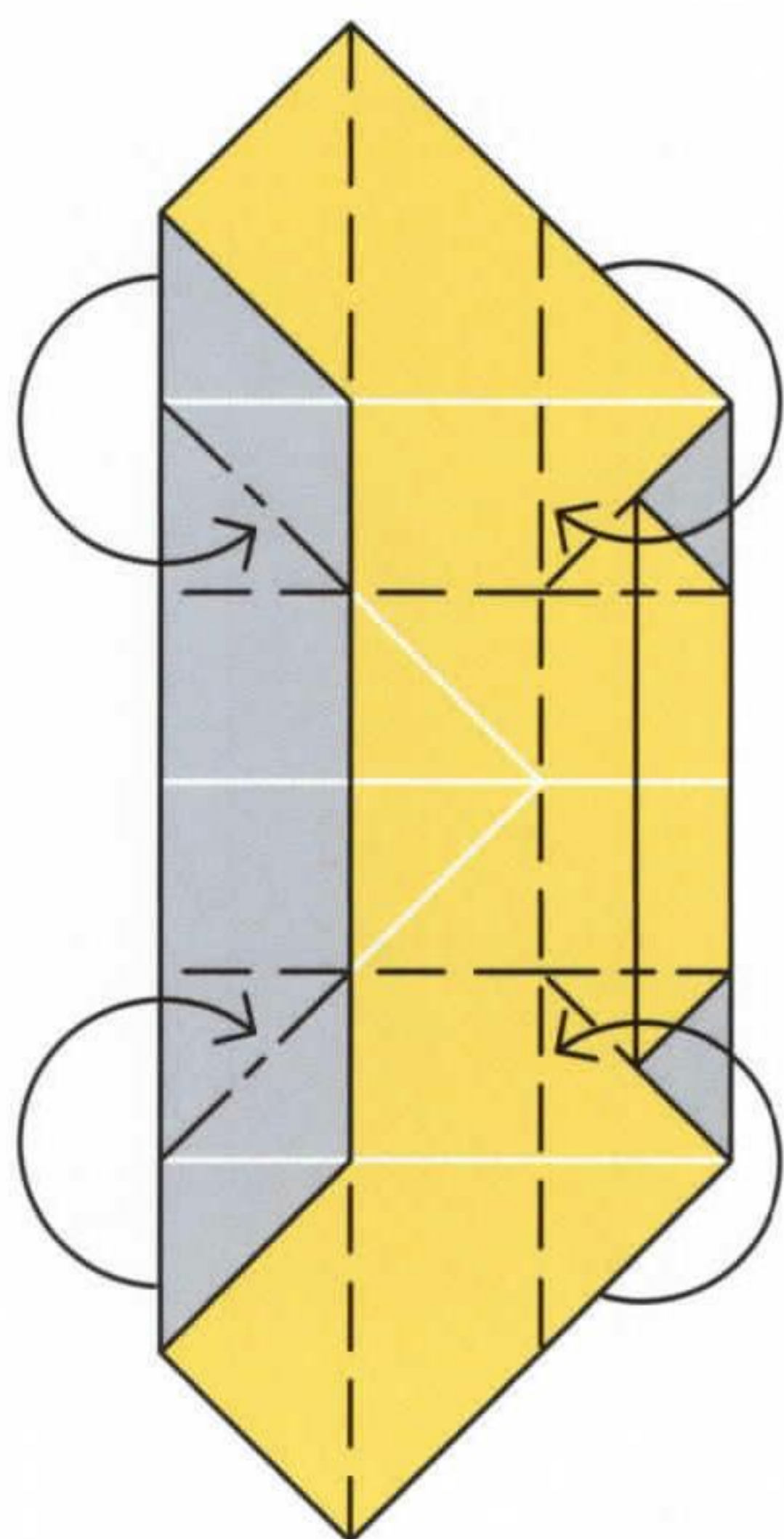

6. Crimp folds

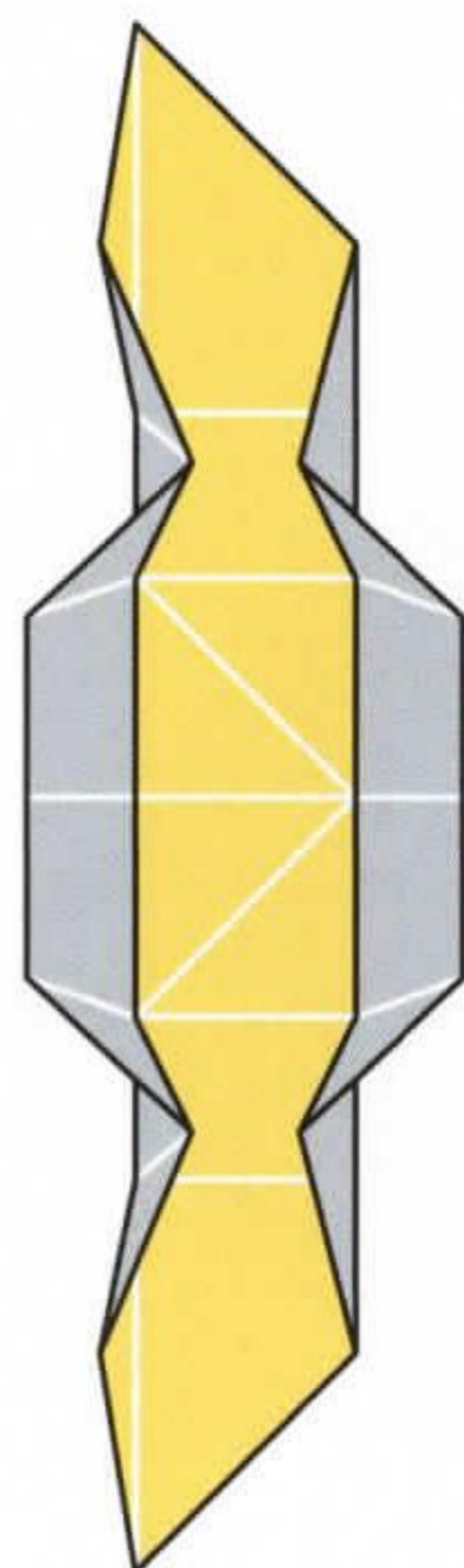

7. Almost complete

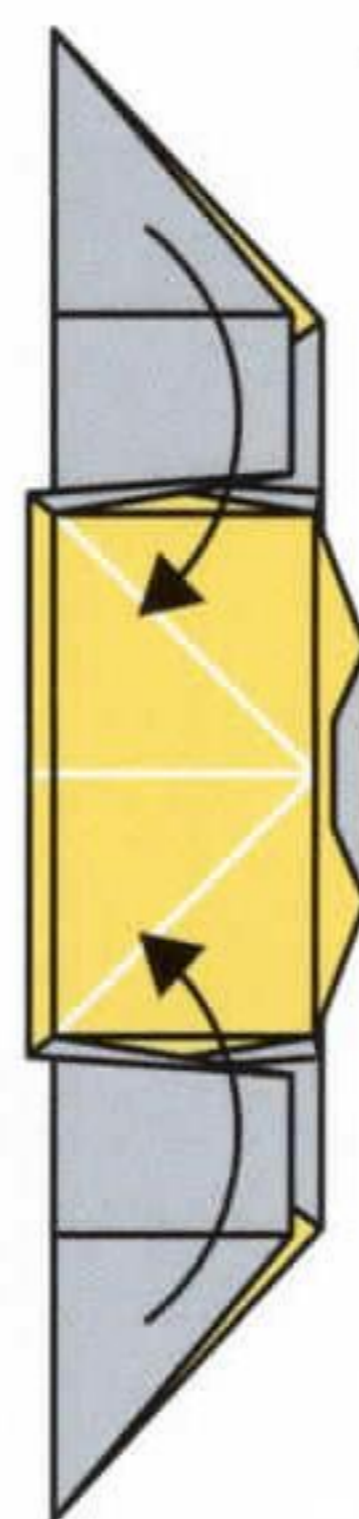

8. Valley folds

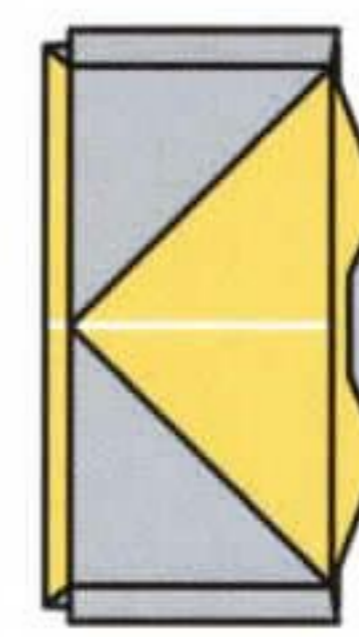

9. Rotate

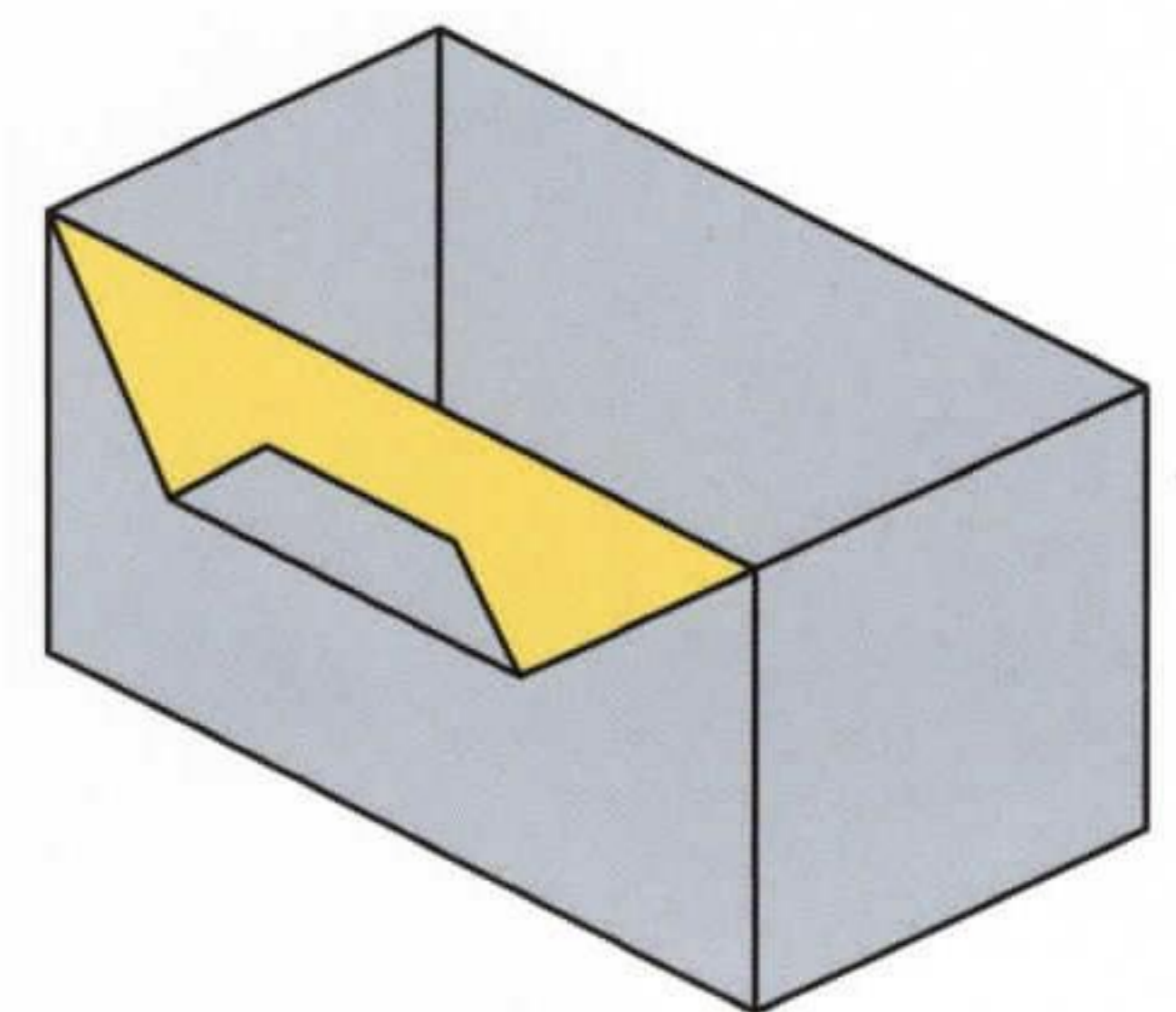

10. Completed PART 4

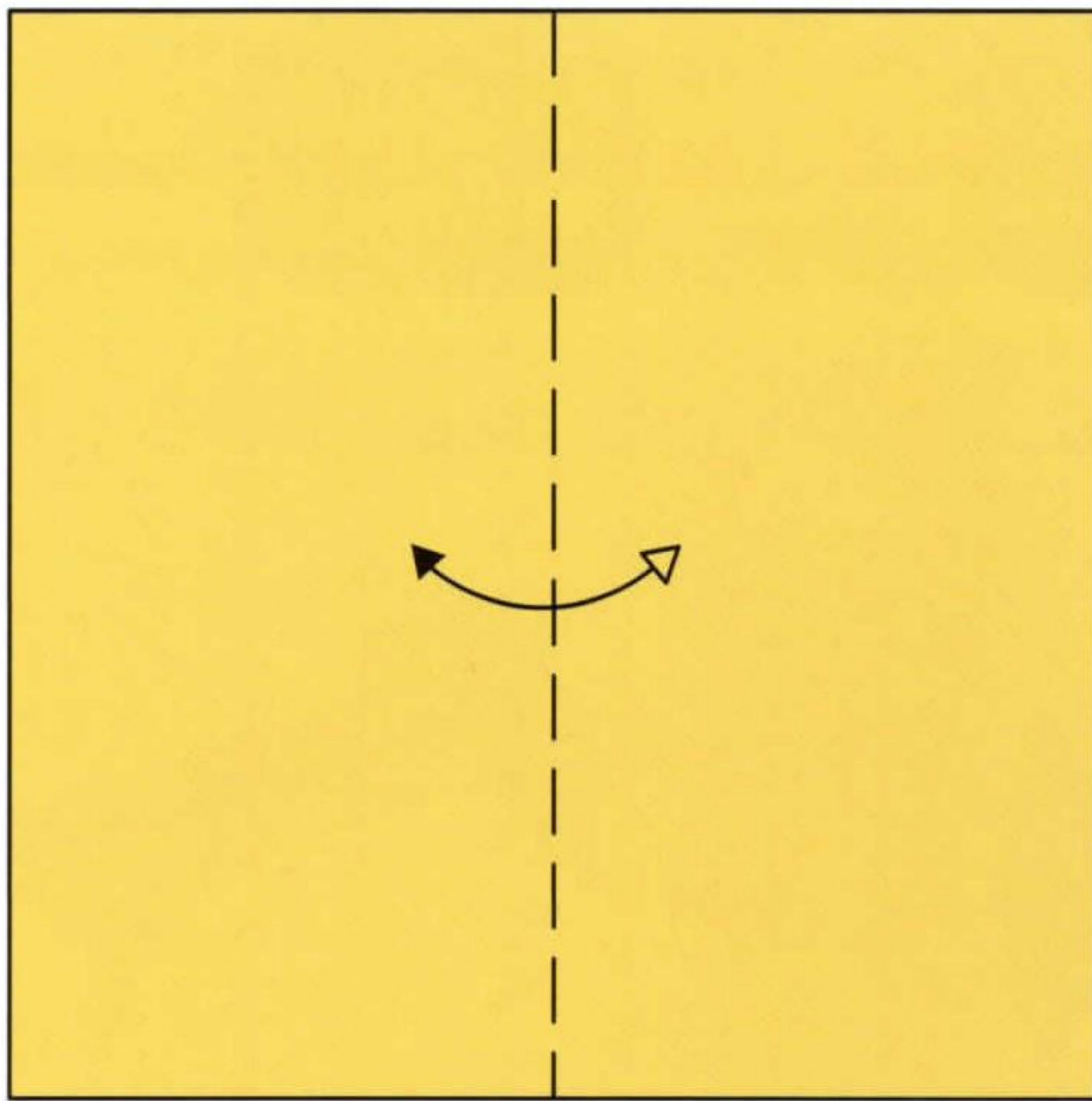

1. Valley fold and unfold

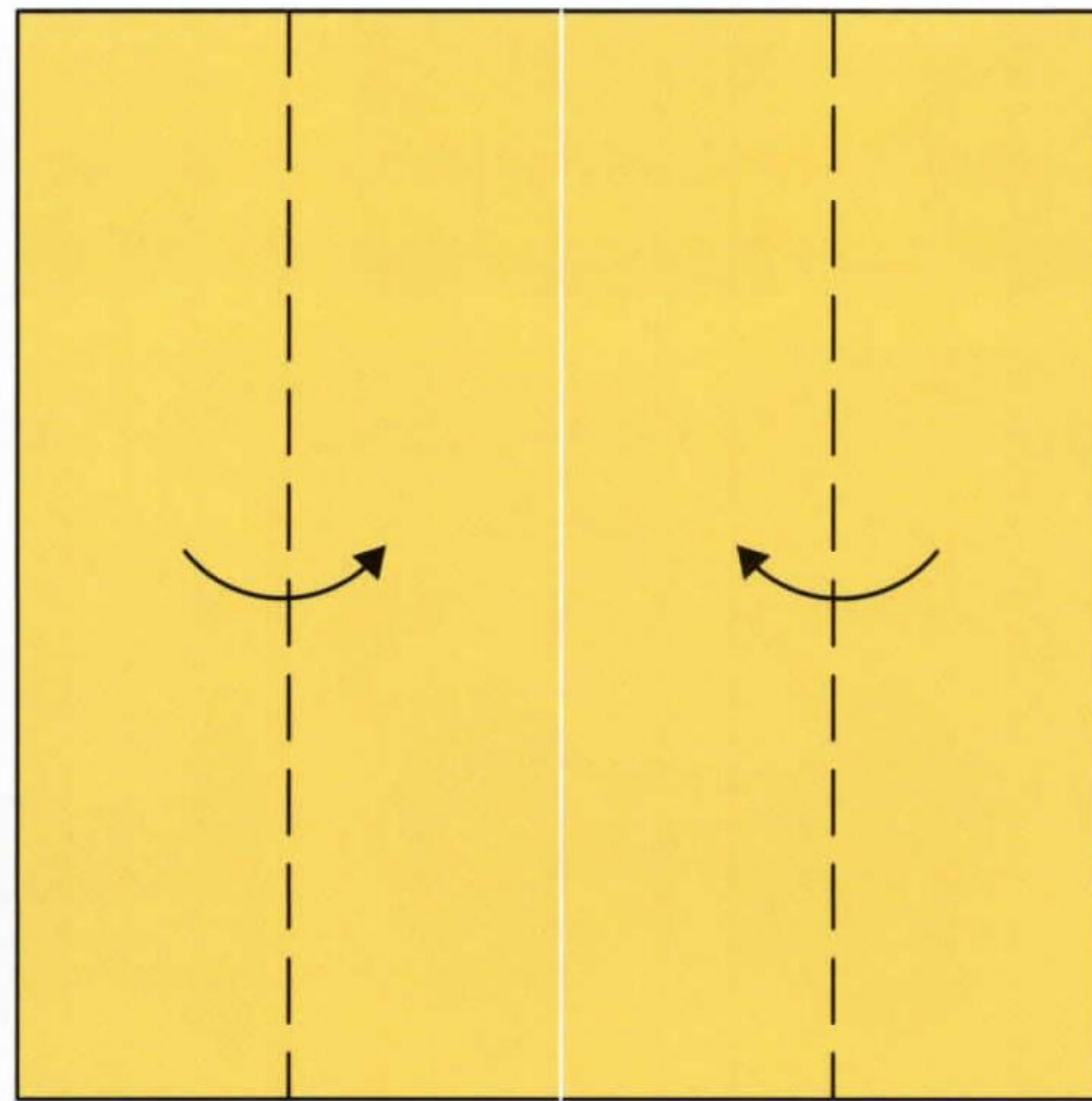

2. Valley folds

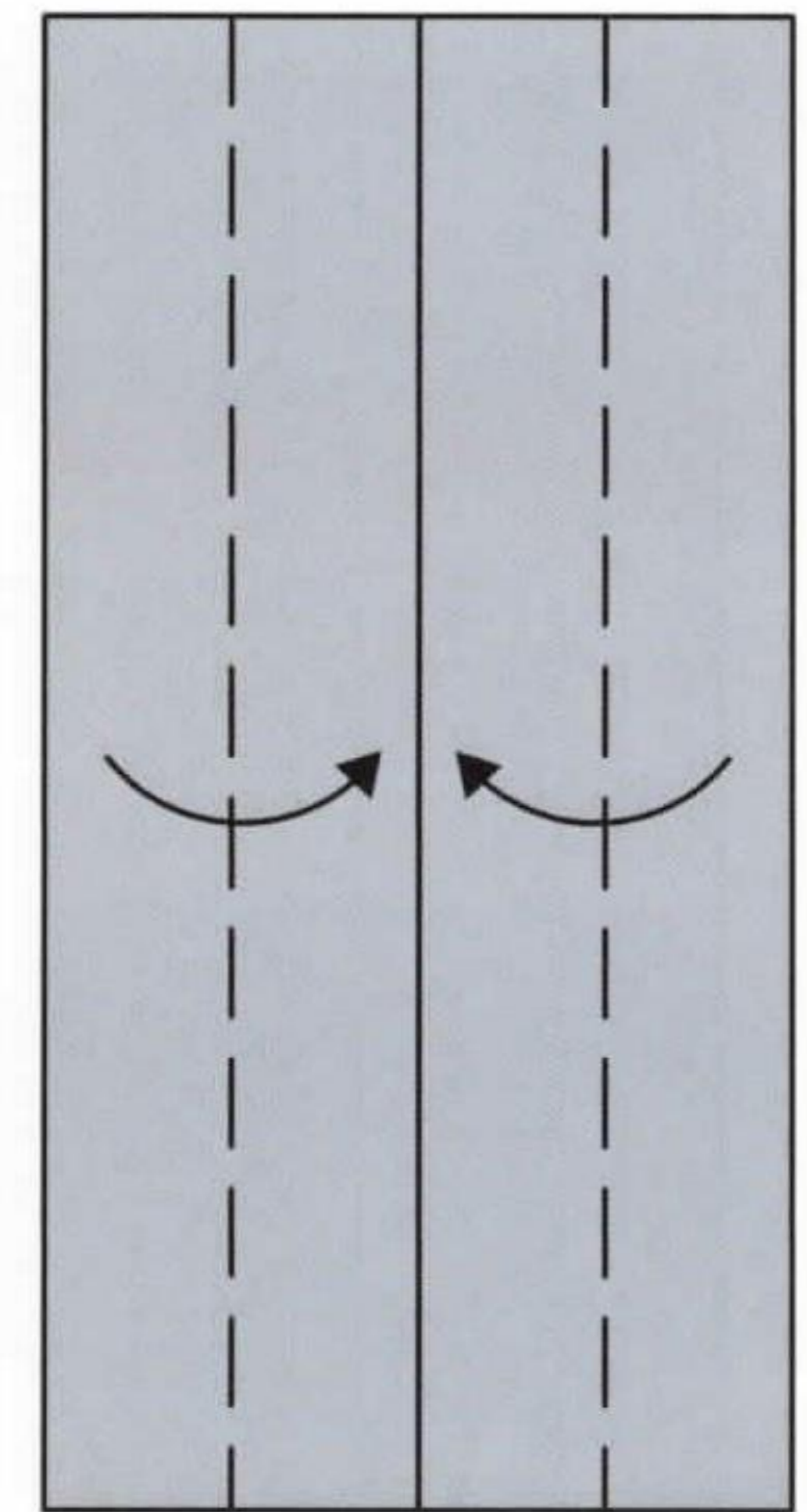

3. Valley folds

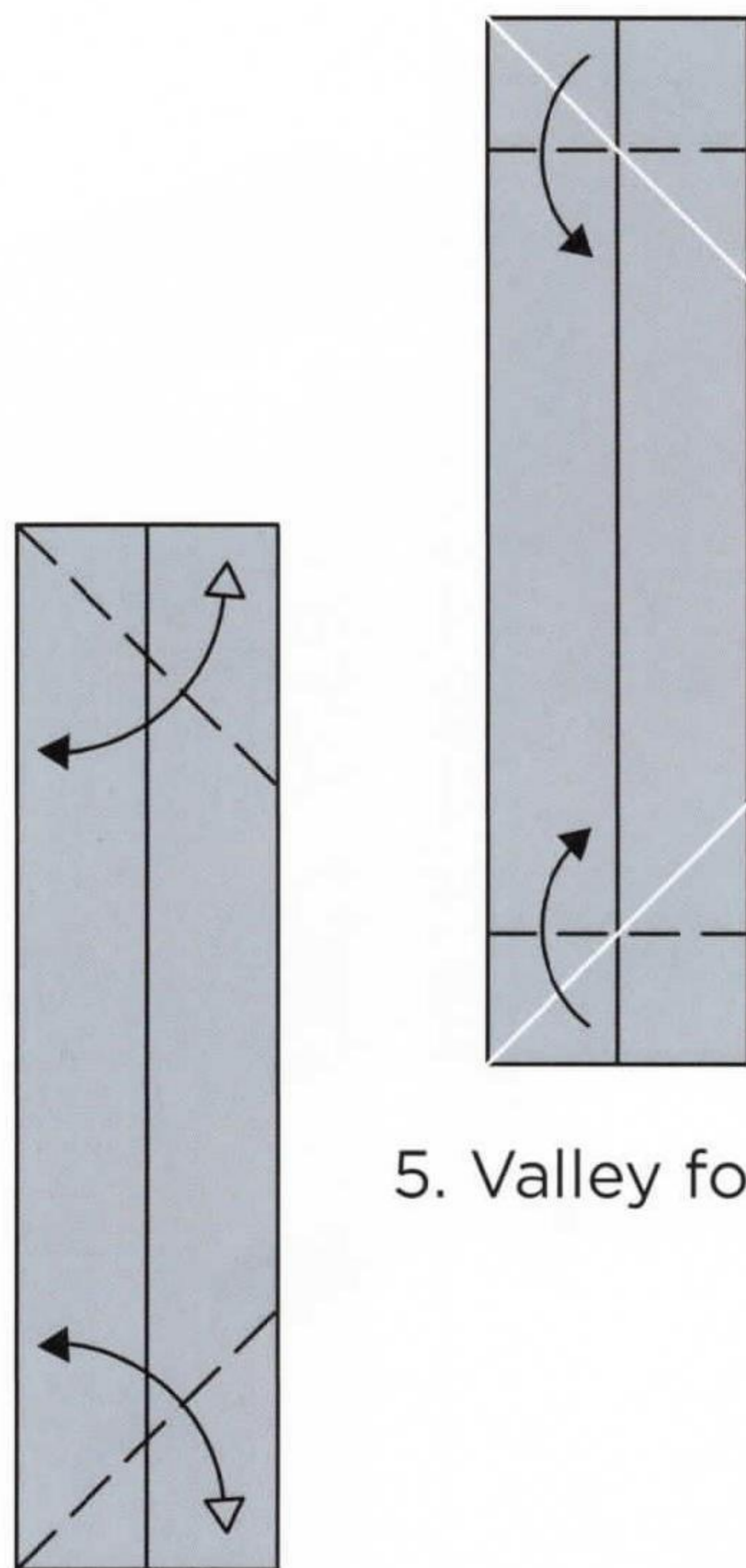

4. Valley folds and unfold

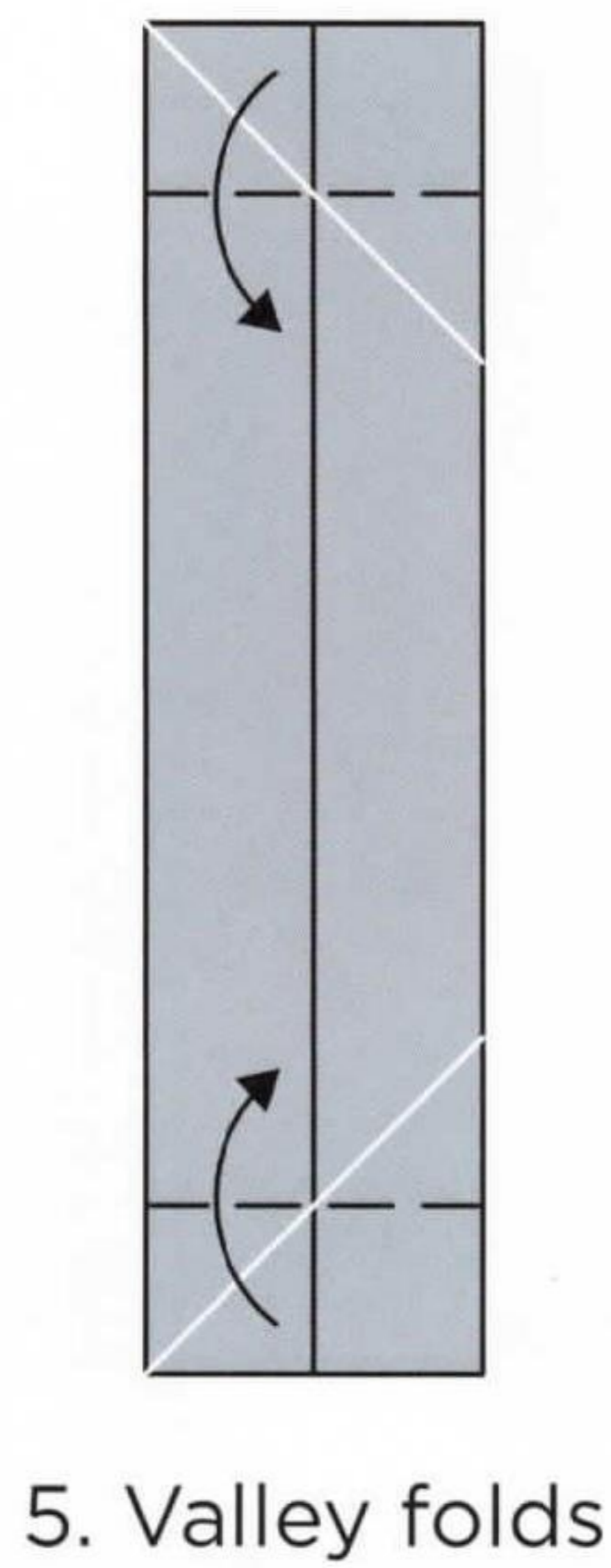

5. Valley folds

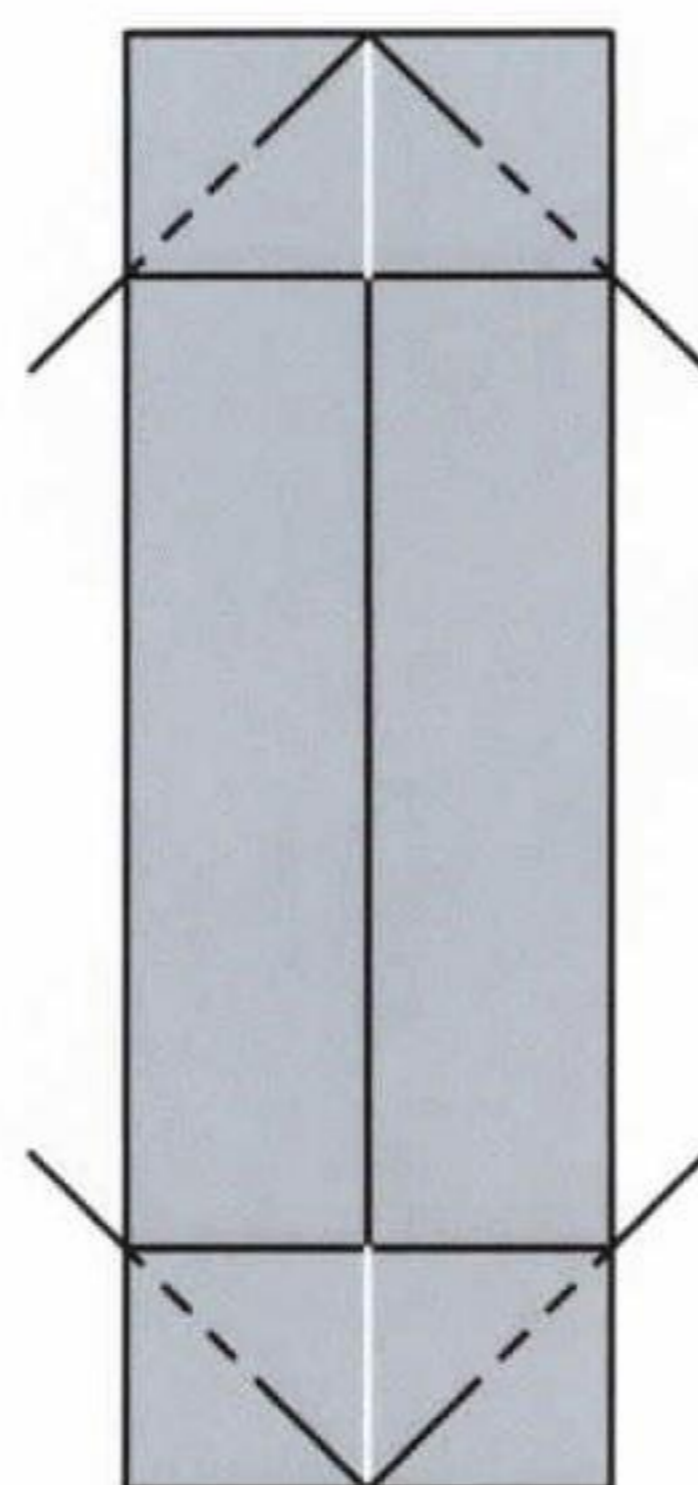

6. Inside reverse folds

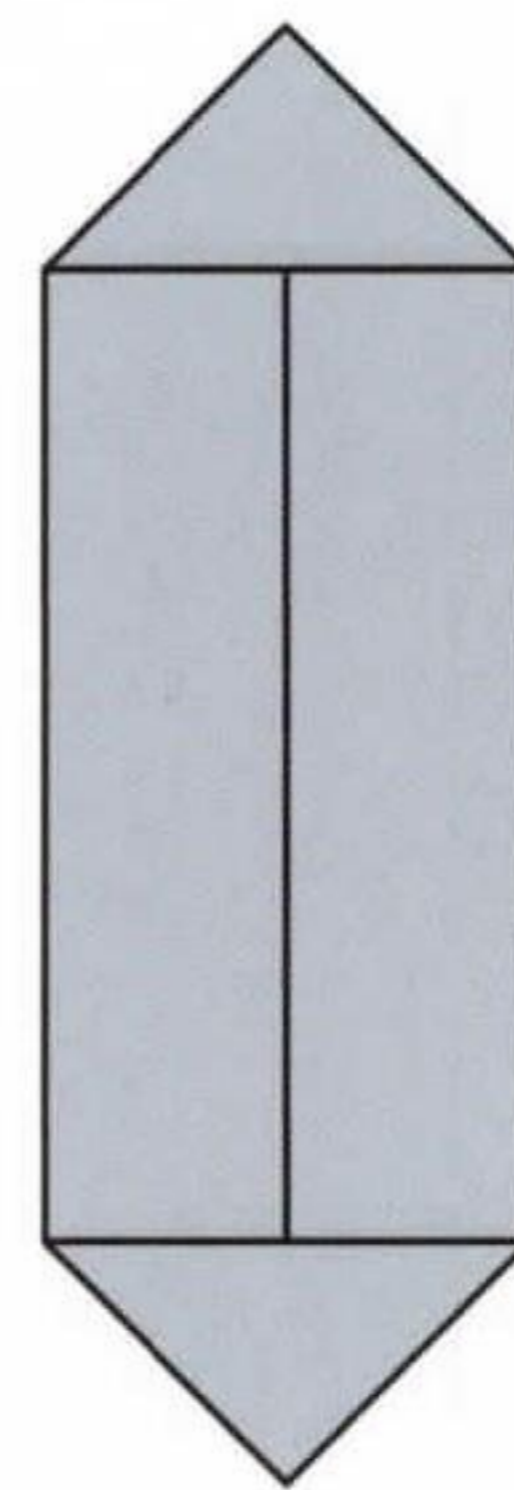

7. Turn over

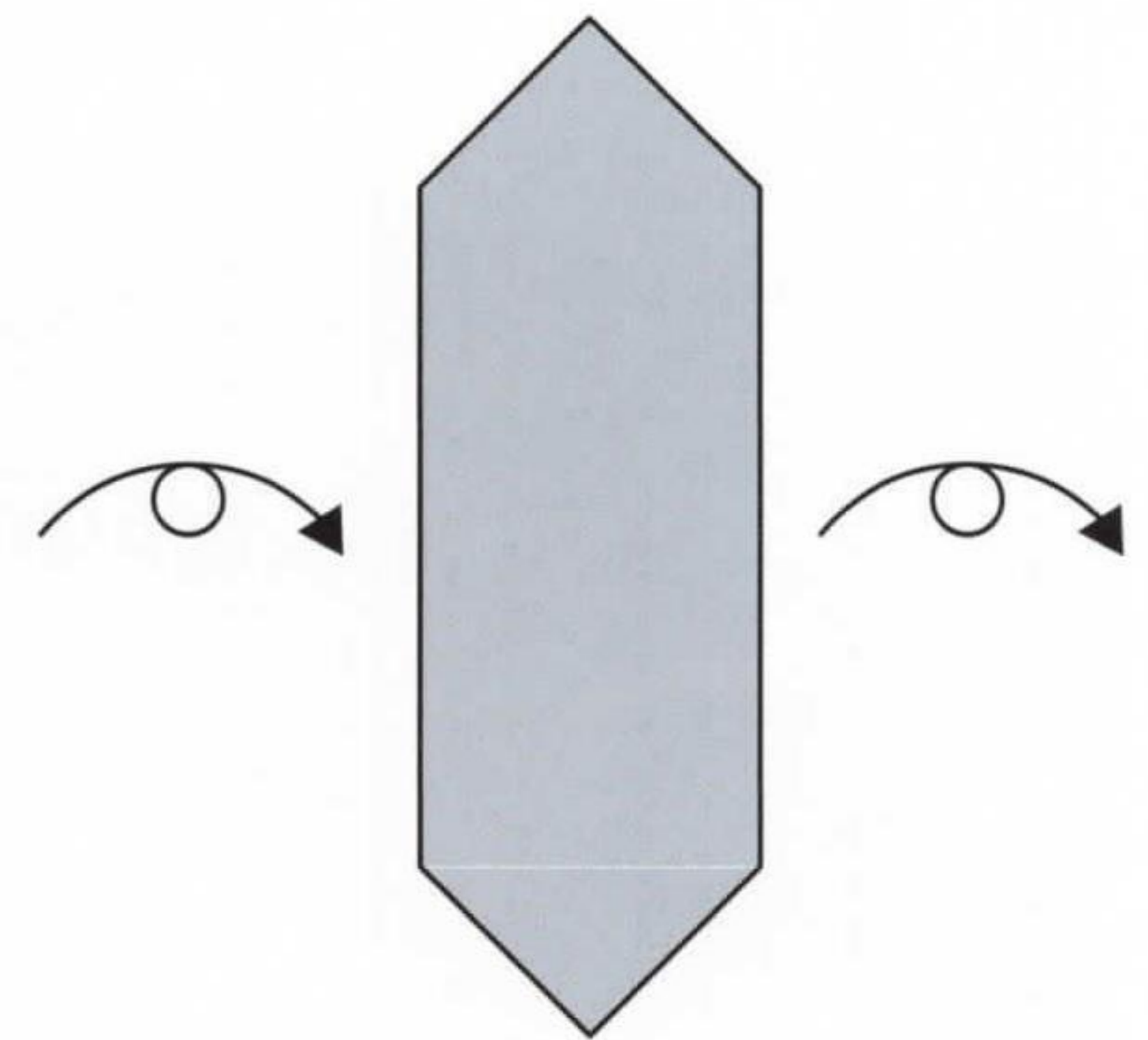

8. Rotate

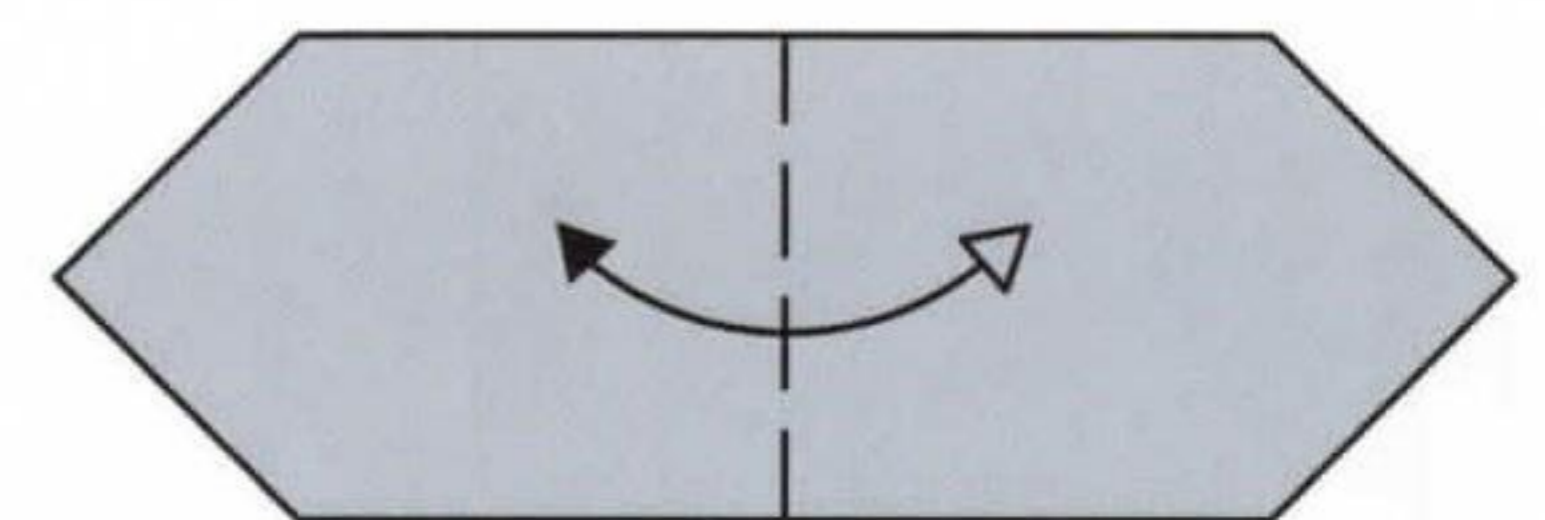

9. Valley fold and unfold

dresser: part 5

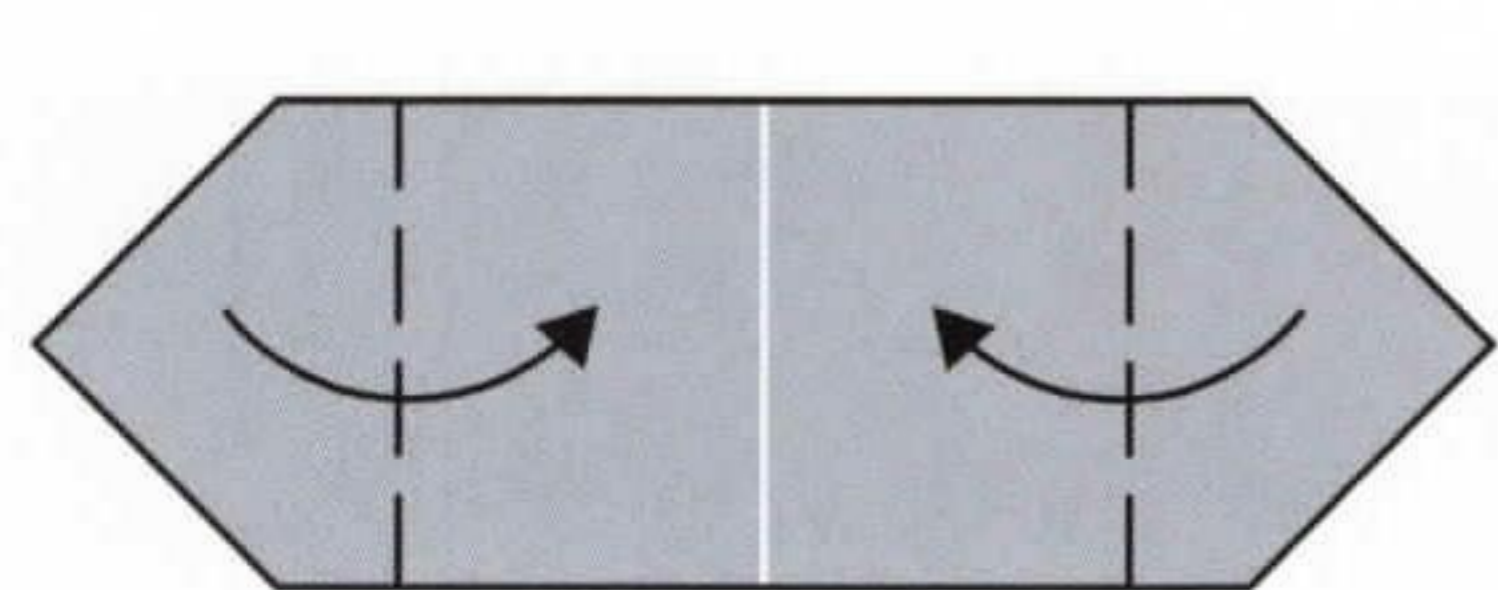

10. Valley folds

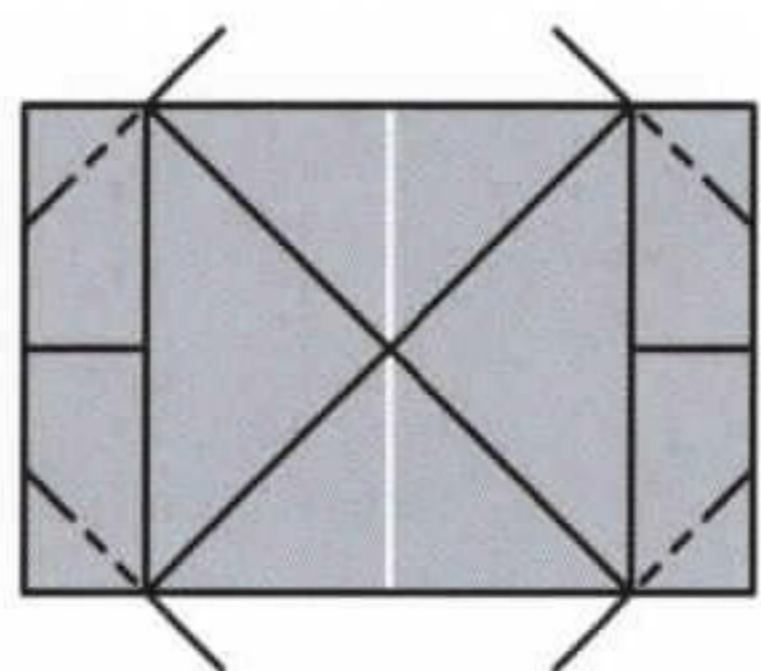

11. Inside reverse folds

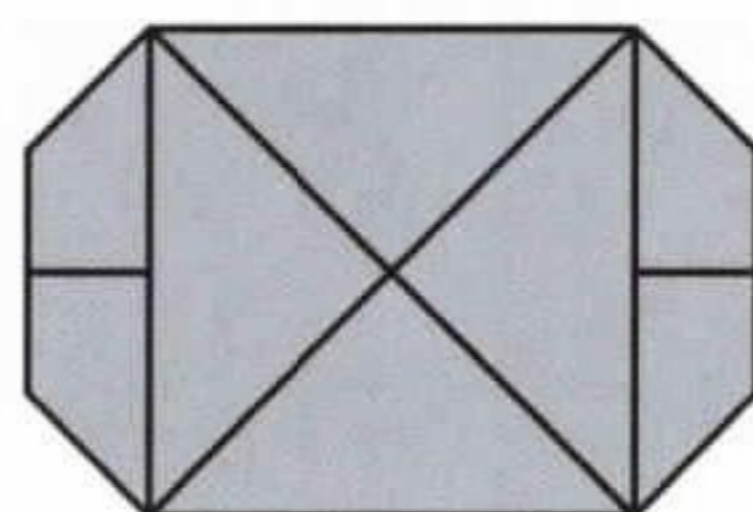

12. Turn over

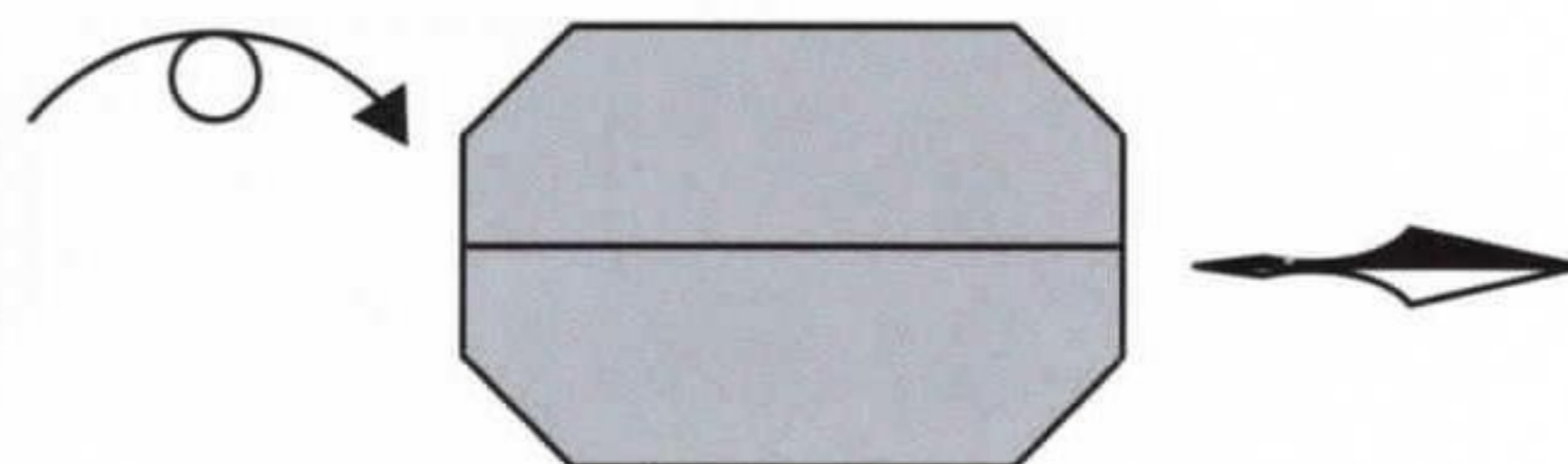

13. Scale-up

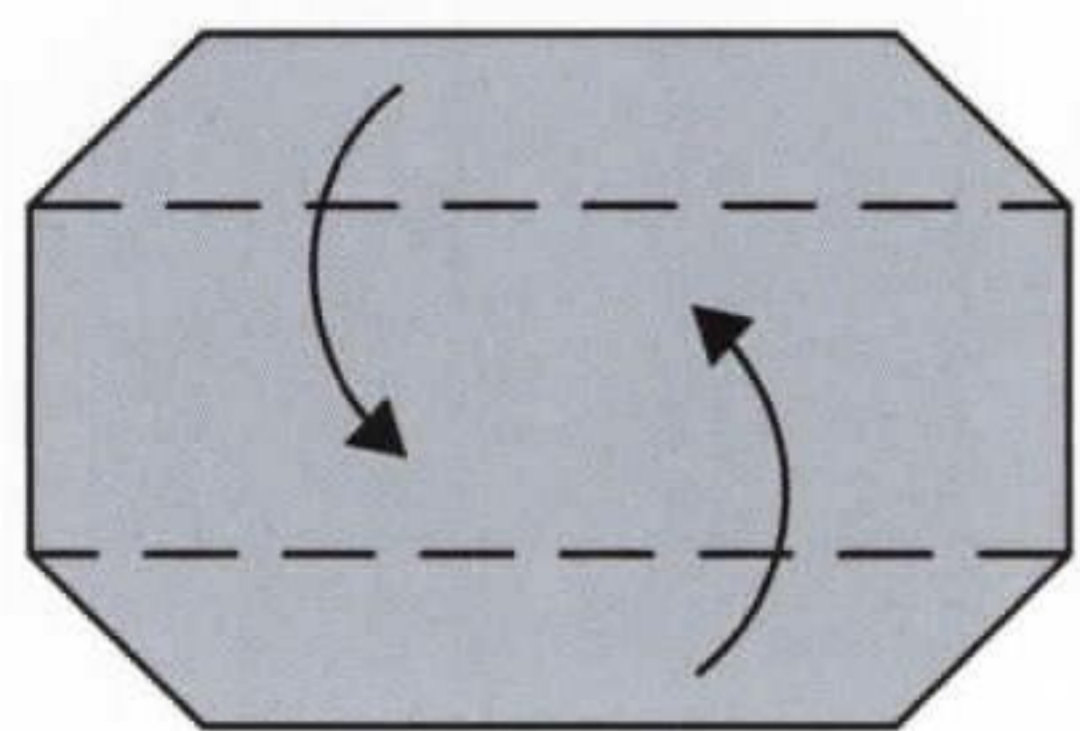

14. Valley folds

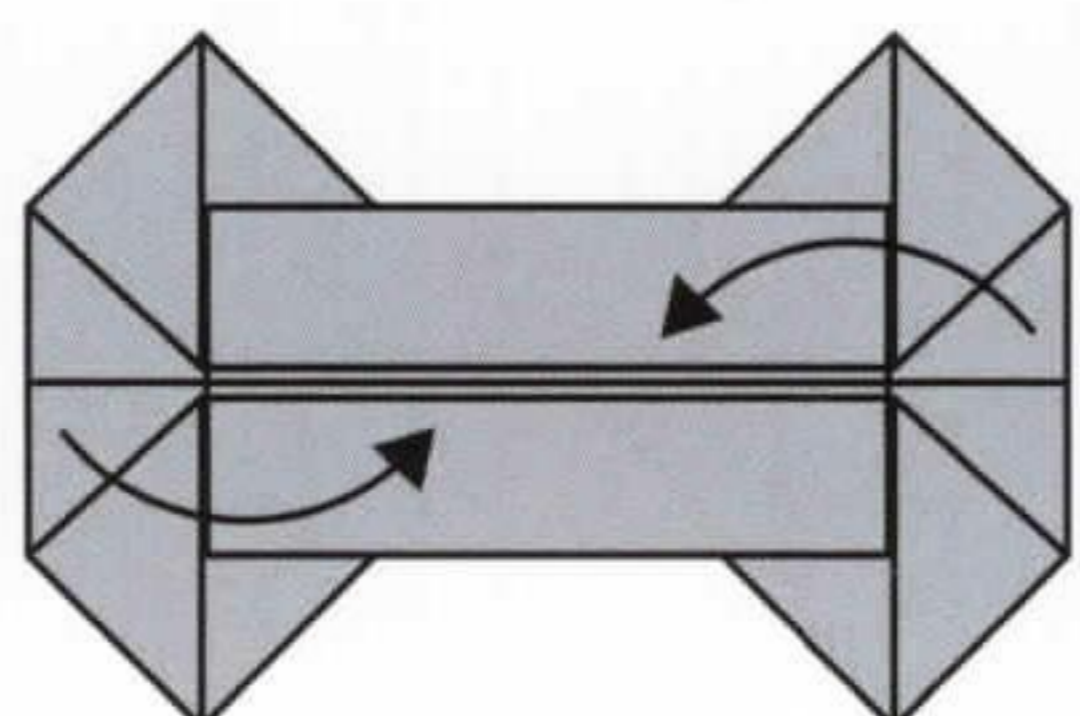

15. Valley folds

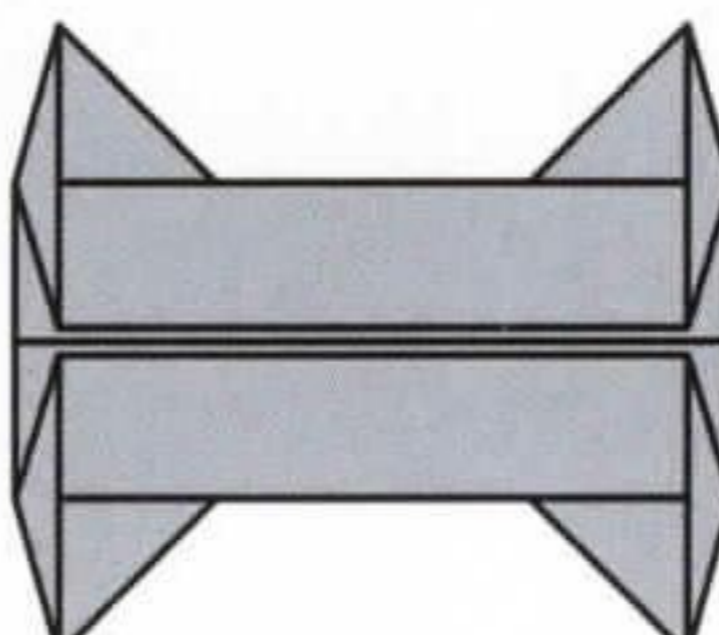

16. Rotate

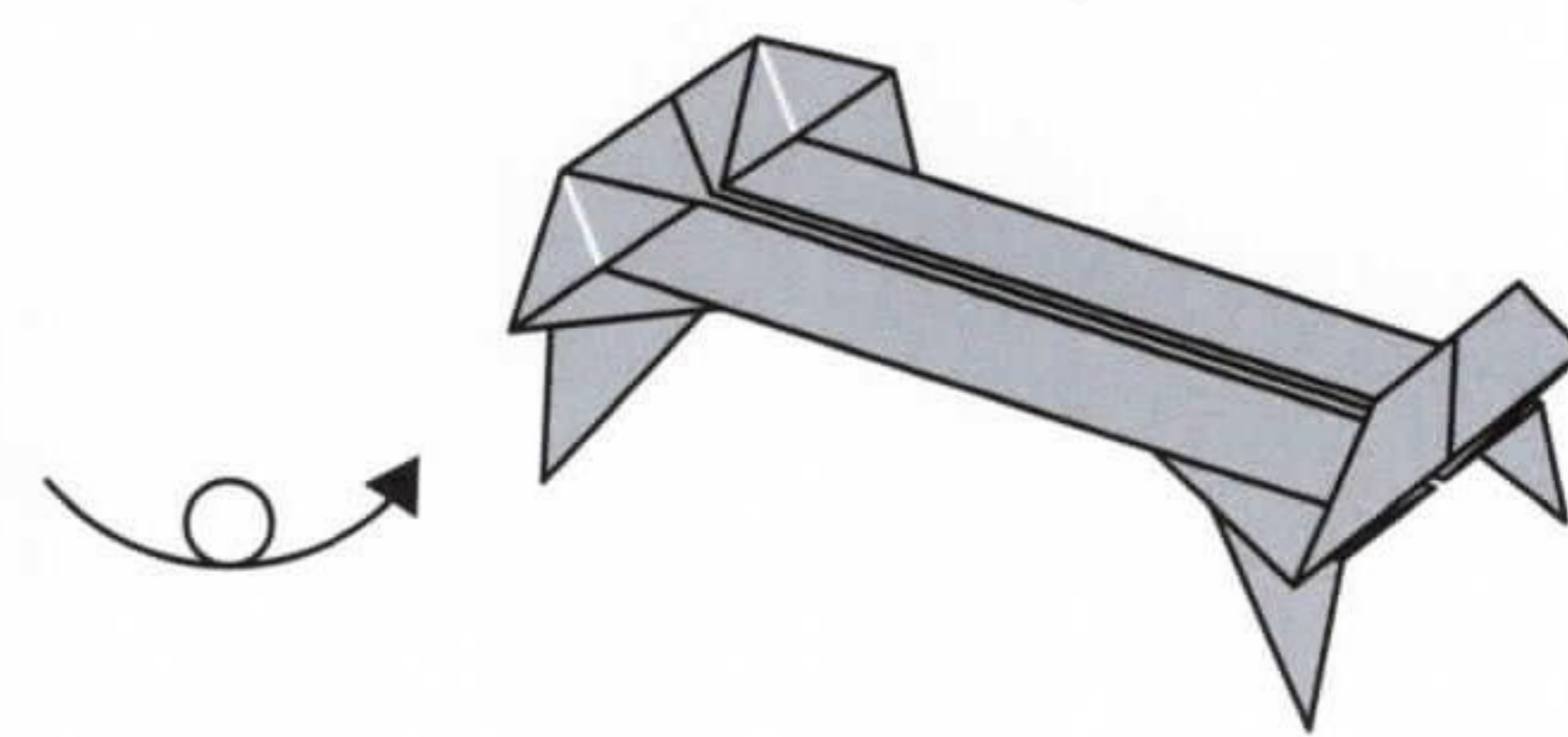

17. Completed PART 5

SECOND ASSEMBLY

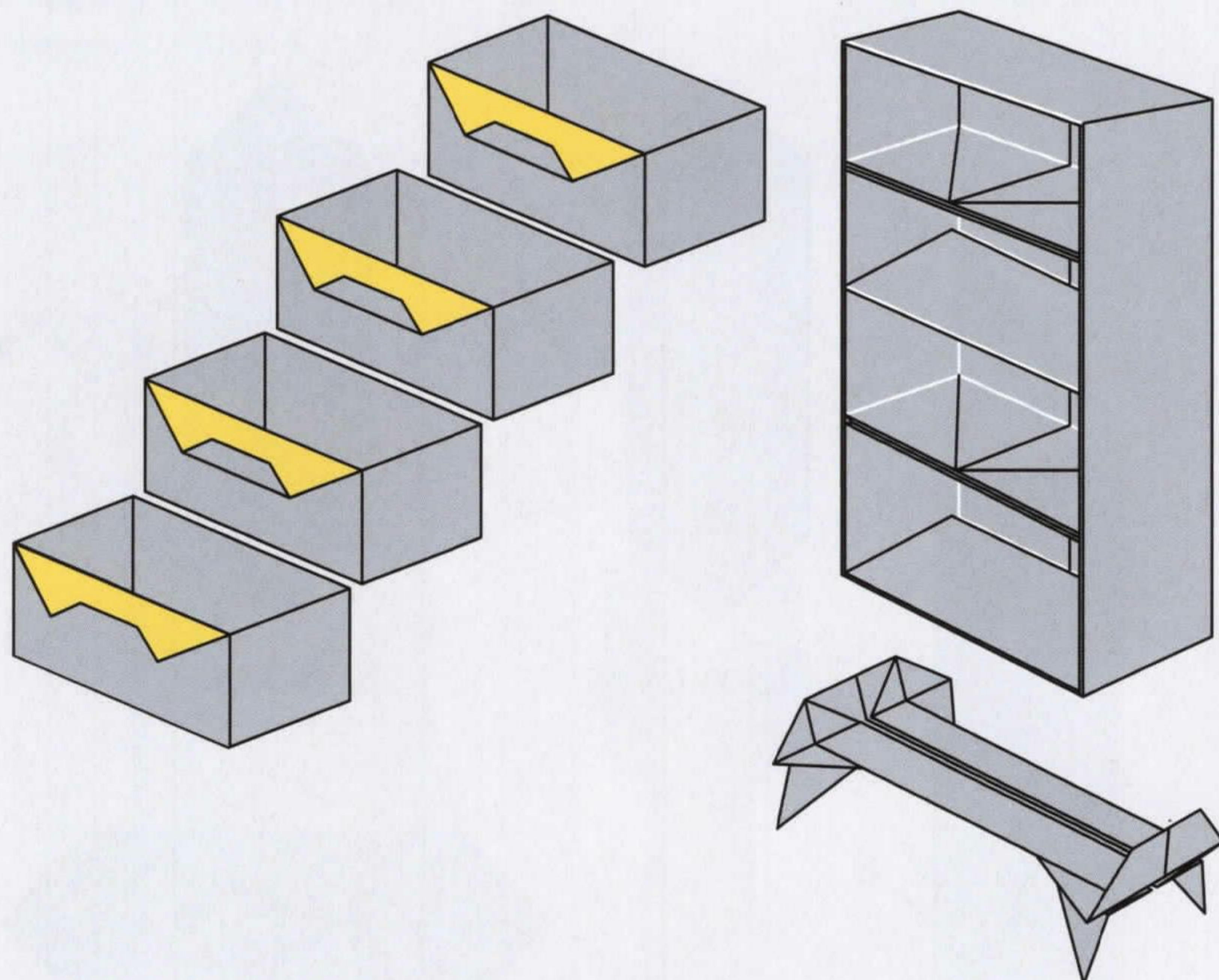

1. Join all parts together as shown and apply glue to hold

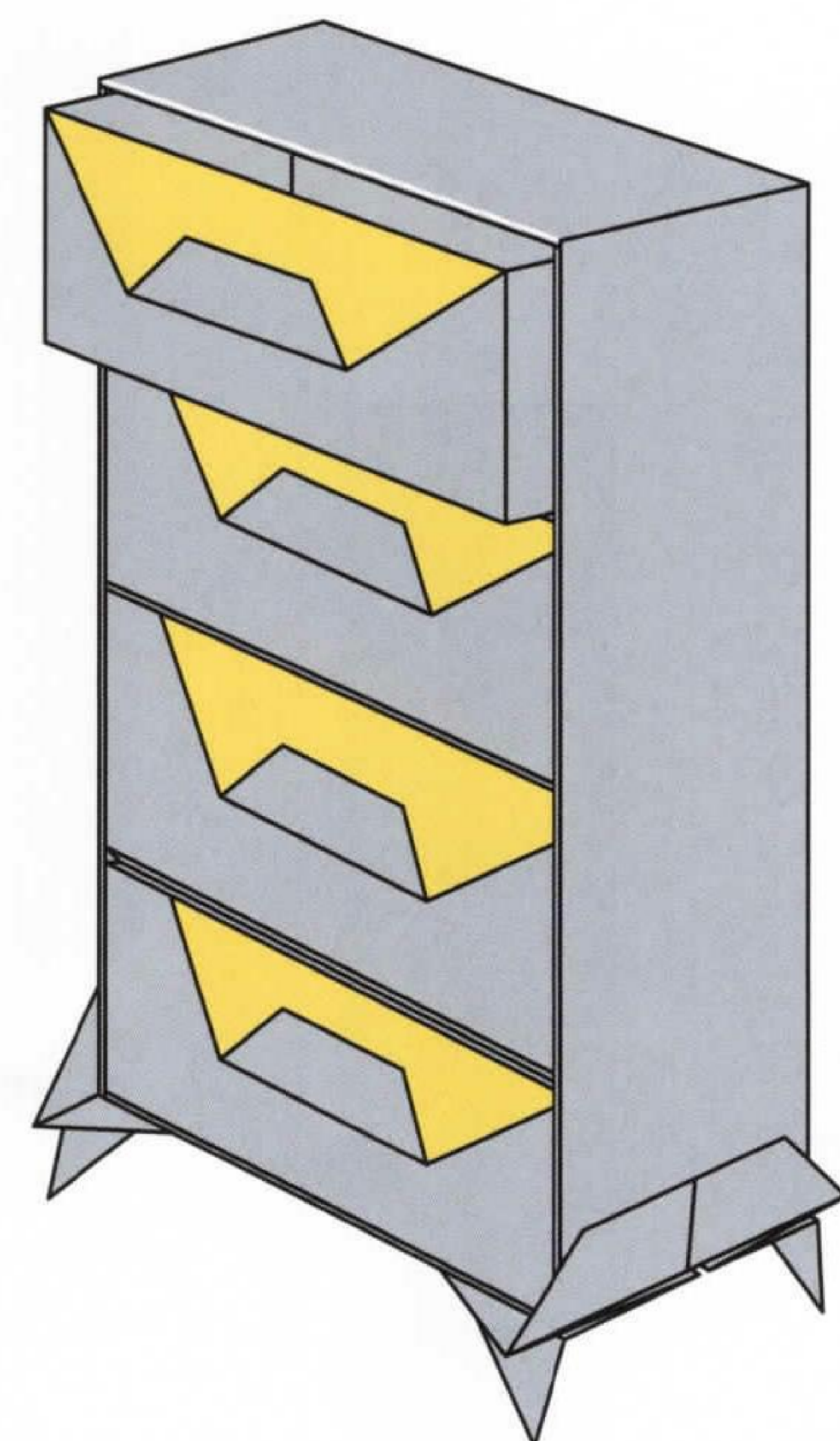

2. Completed DRESSER

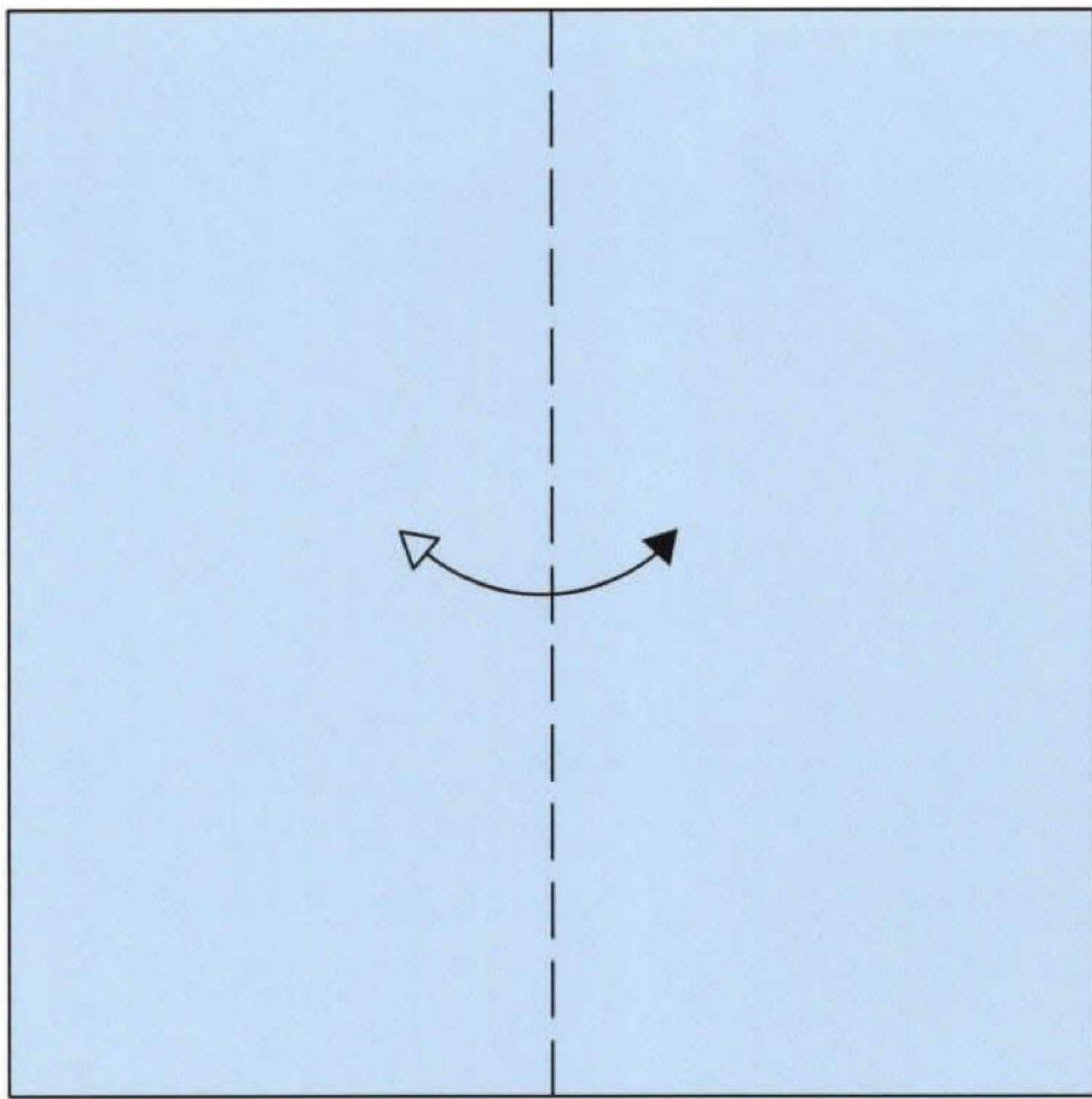

1. Valley fold and unfold

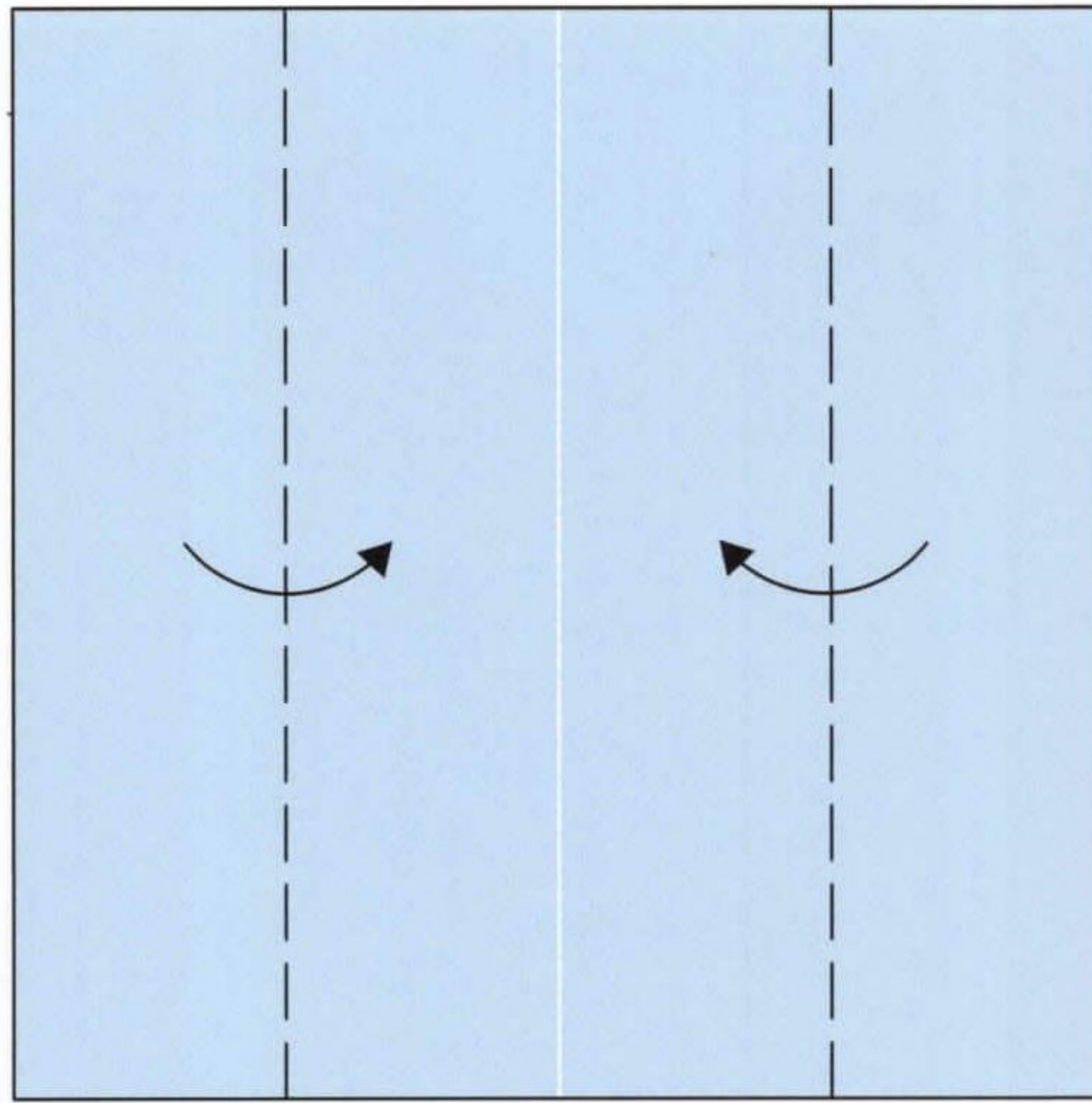

2. Valley folds

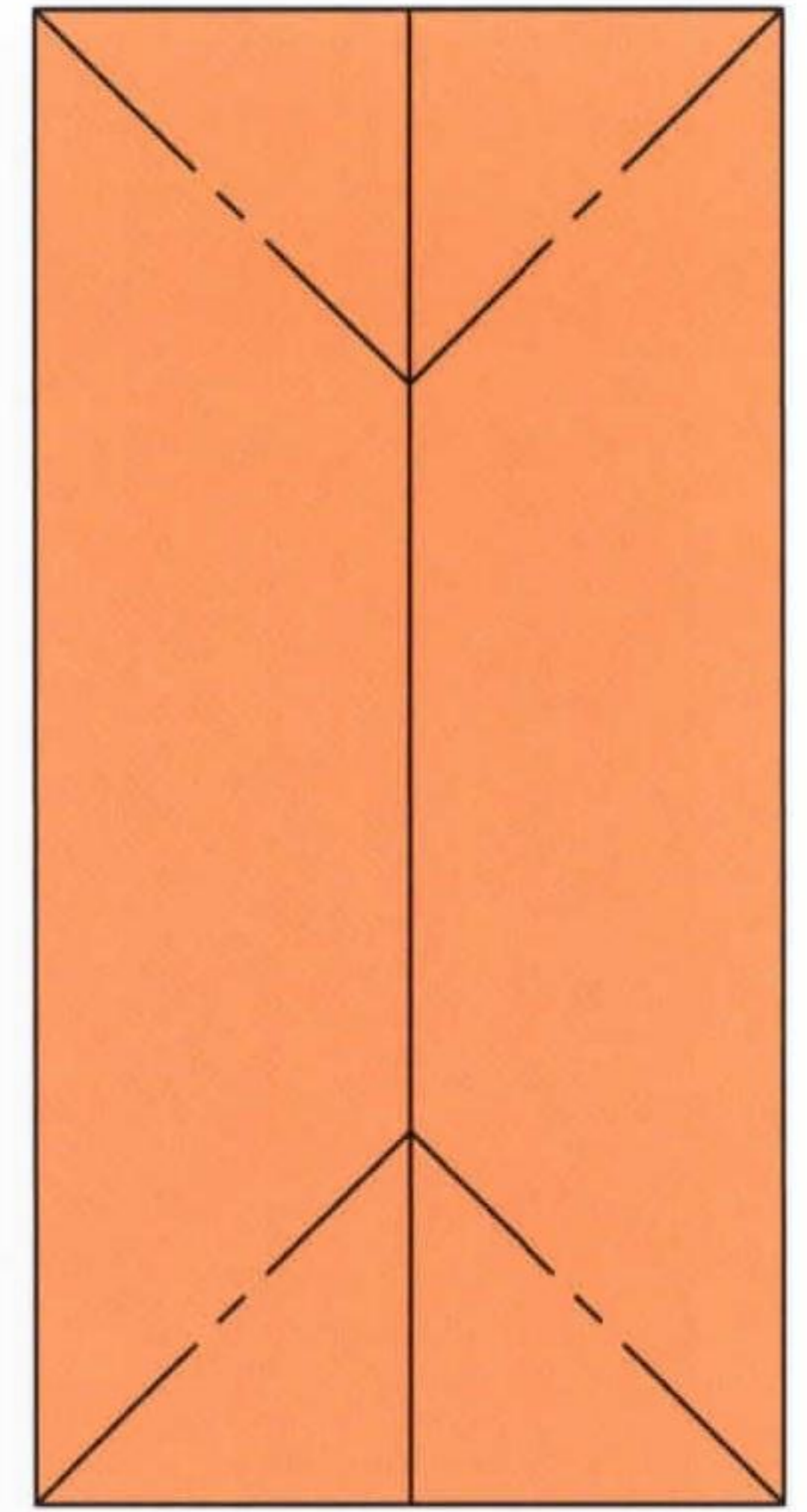

3. Mountain folds

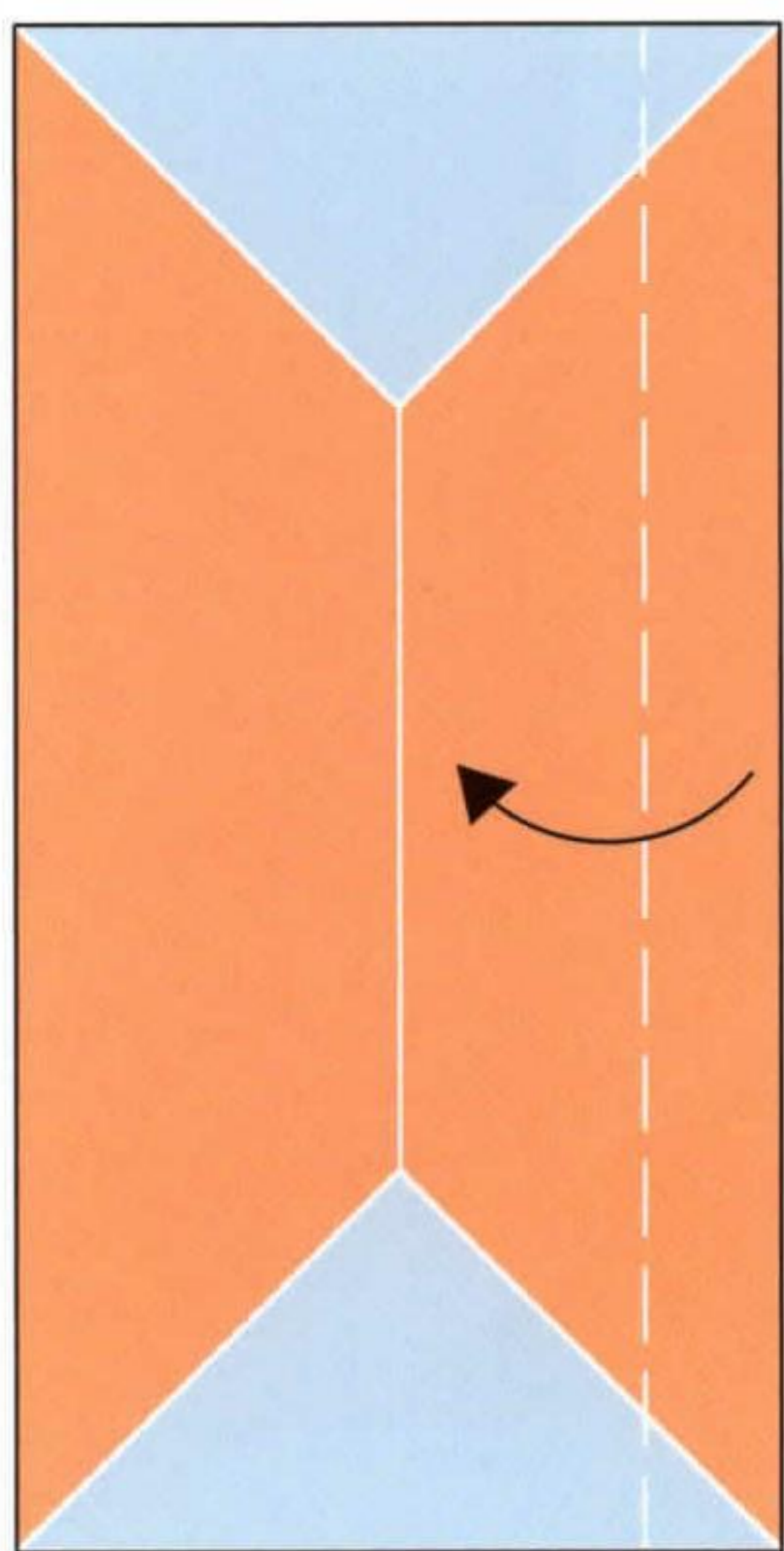

4. Valley fold

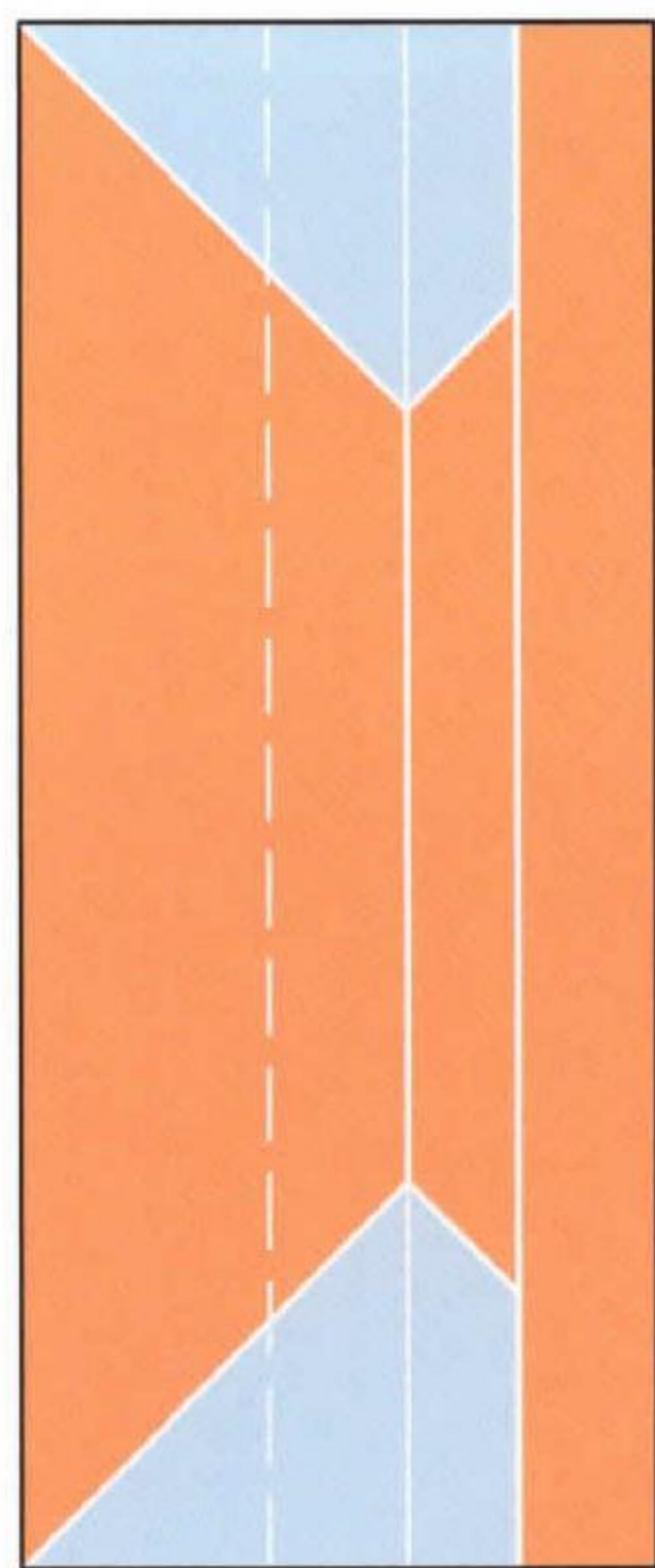

5. Valley fold

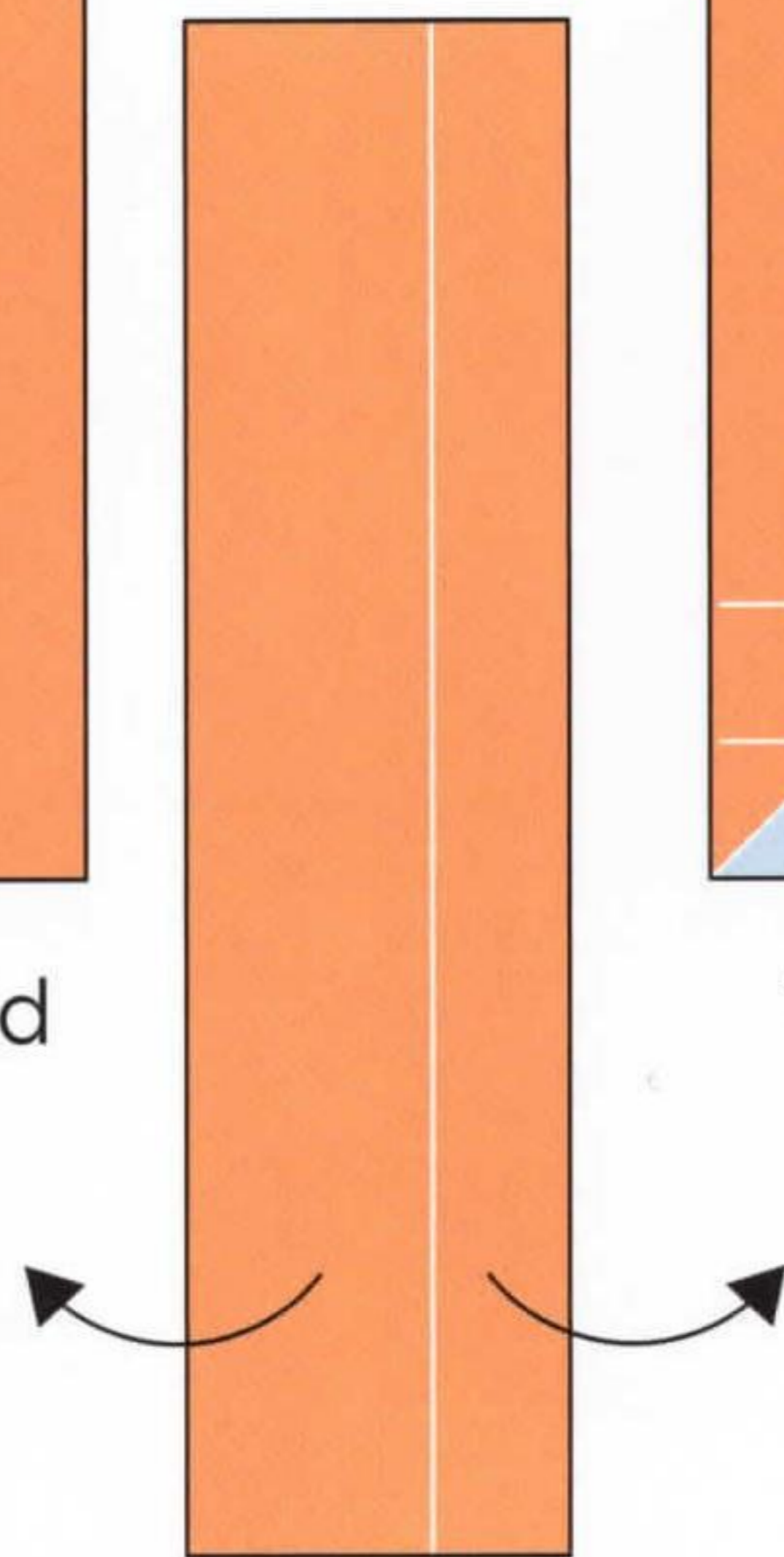

6. Valley folds to unfold

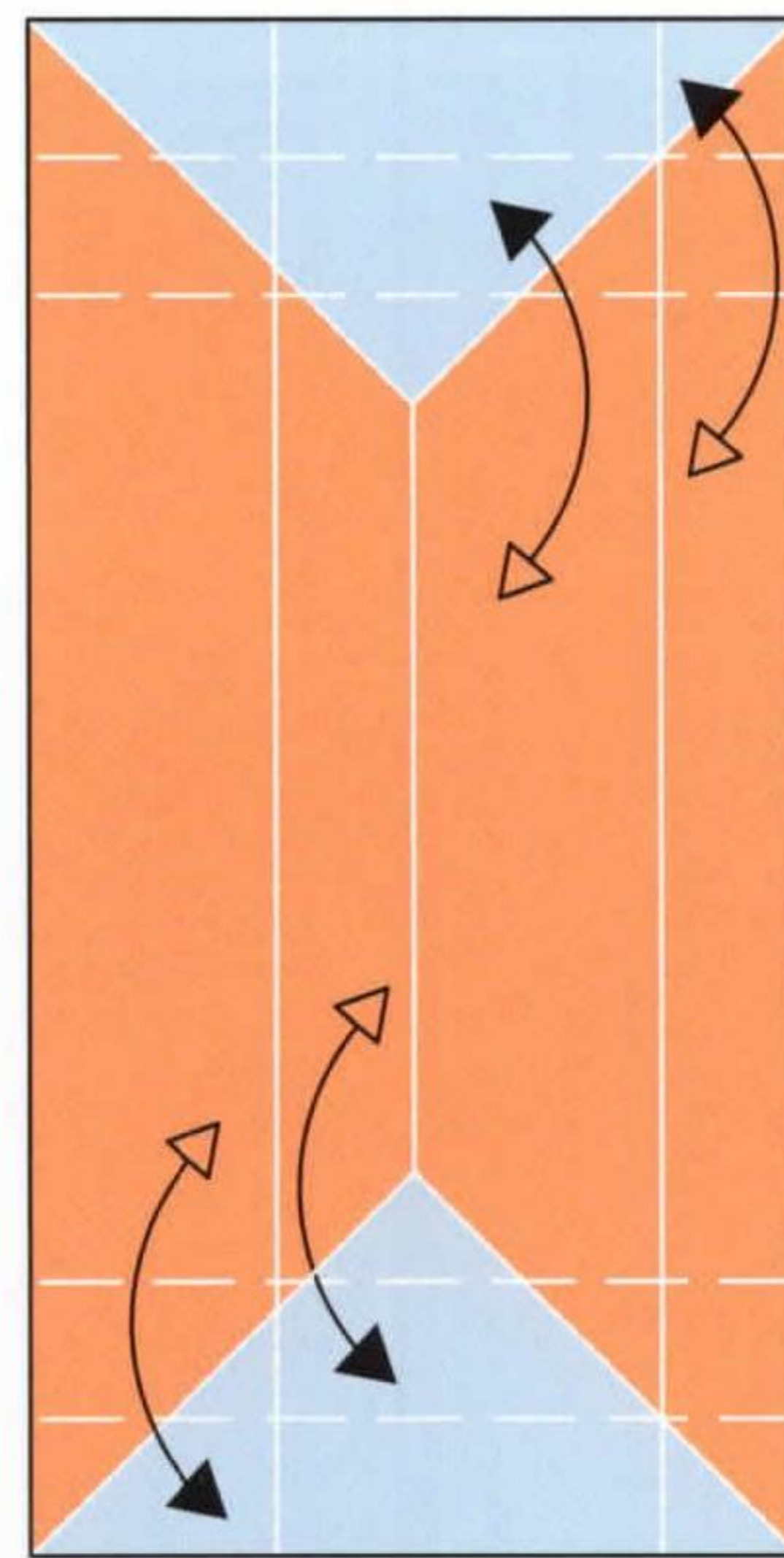

7. Valley folds and unfold

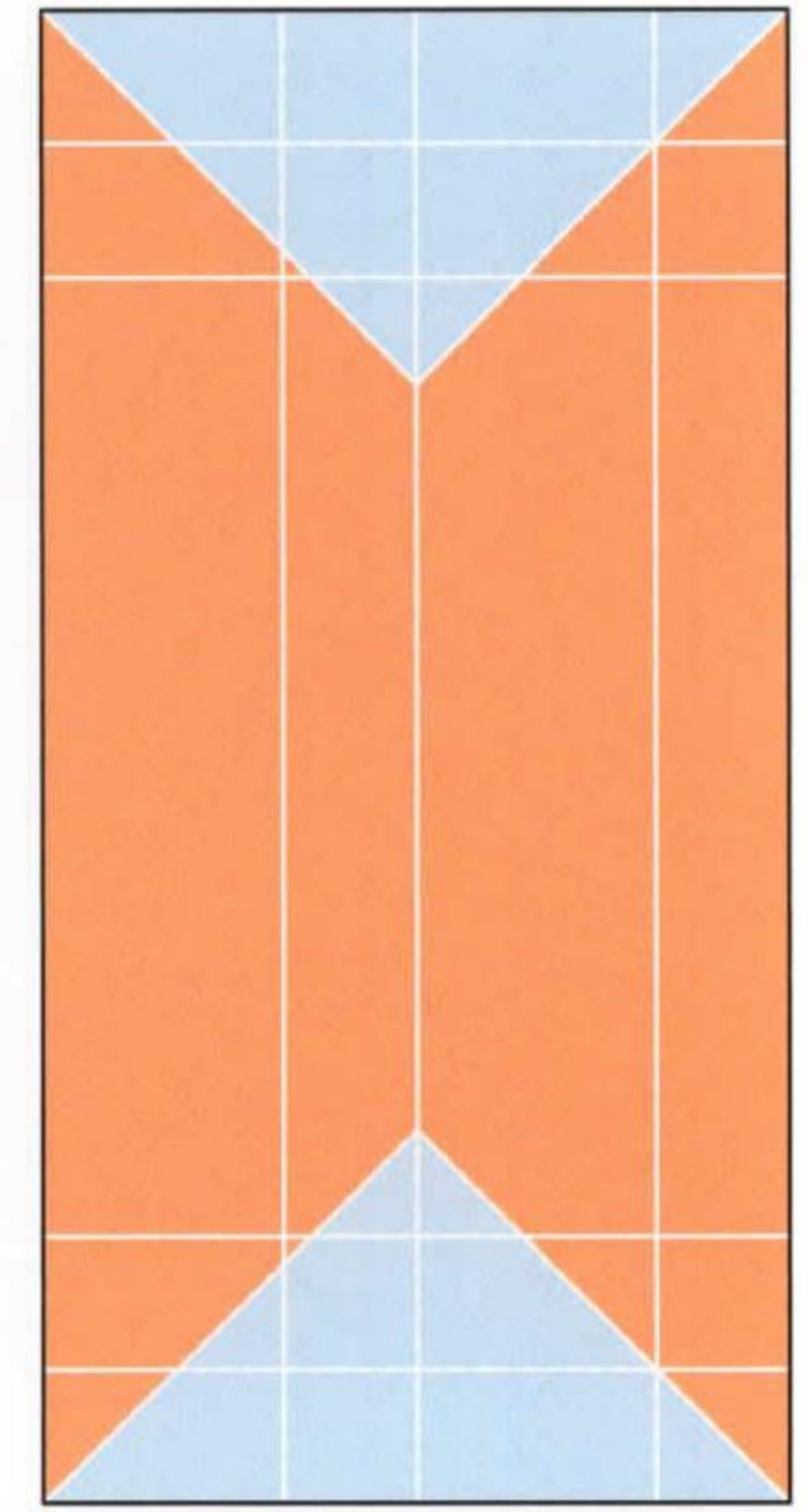

8. Scale-up

wardrobe: part 1

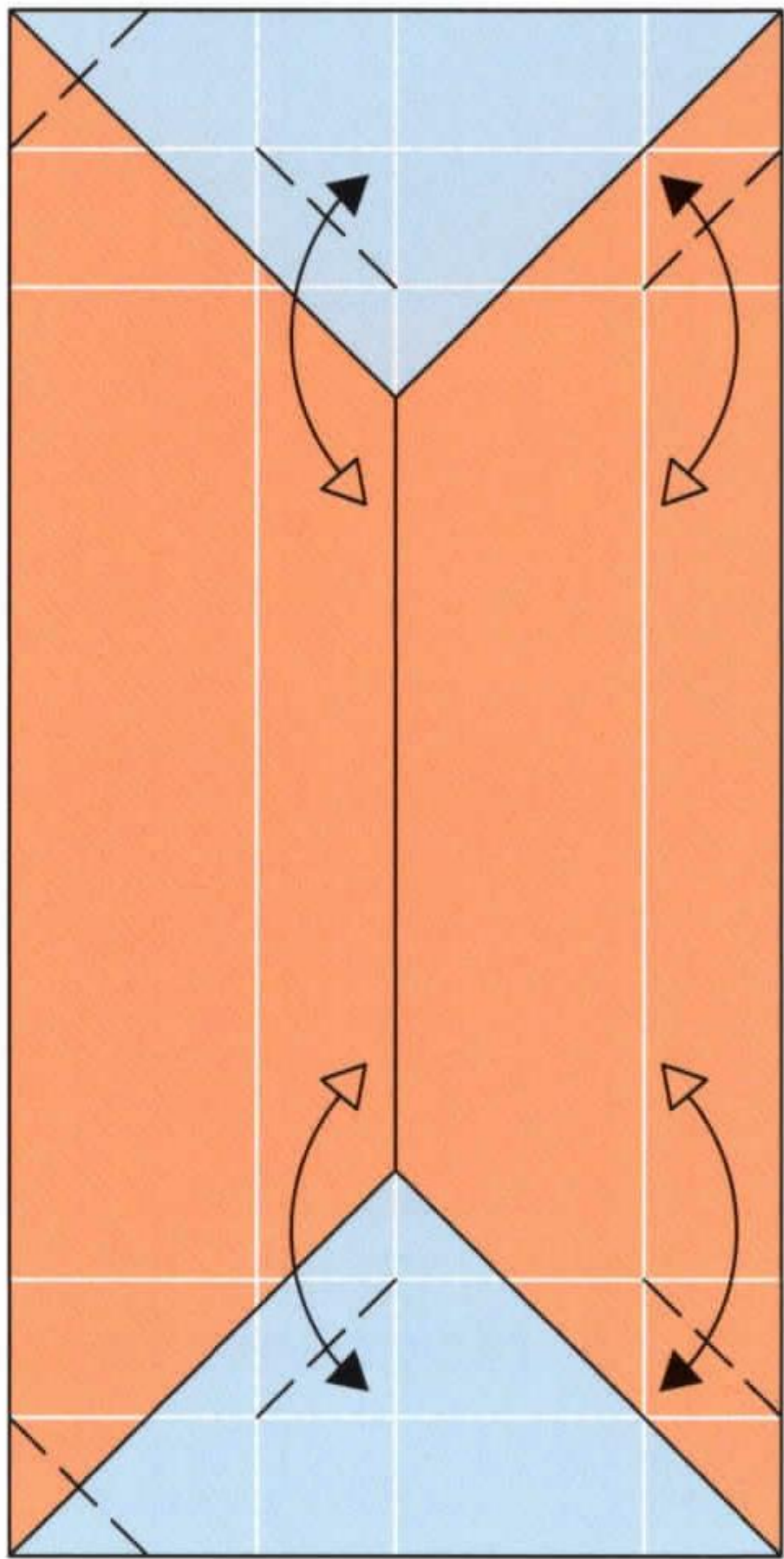

9. Valley fold and unfold

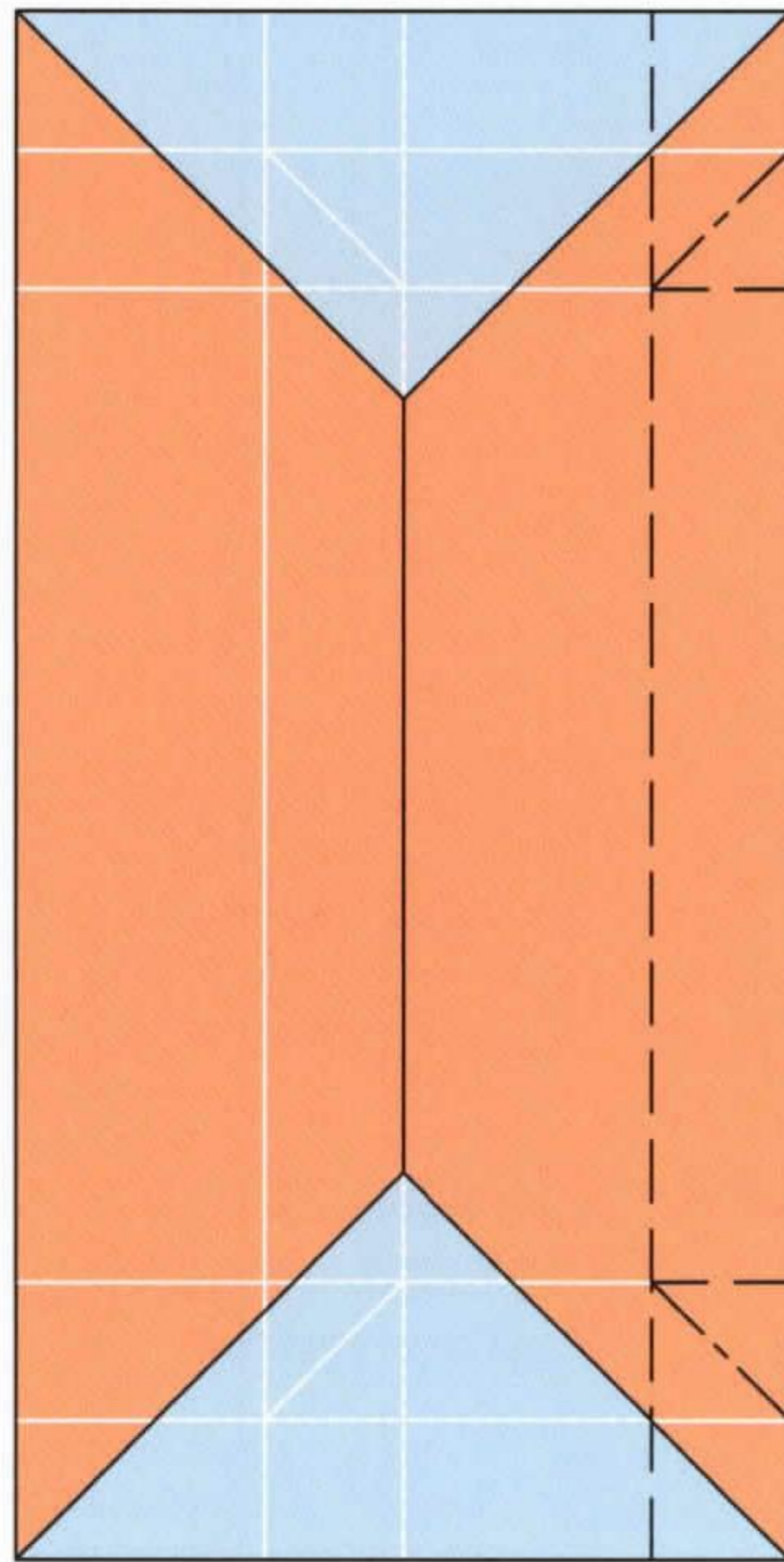

10. Crimp folds

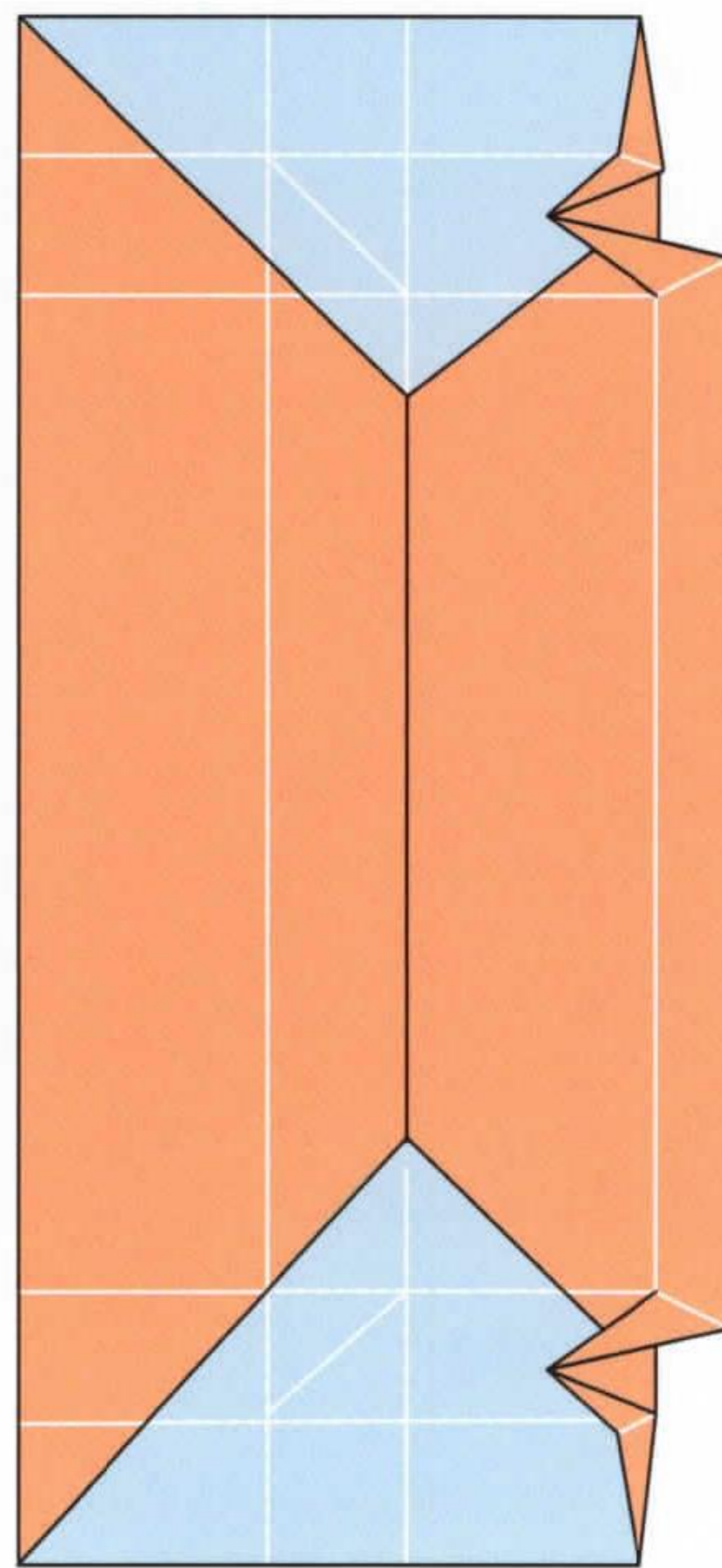

11. Before complete

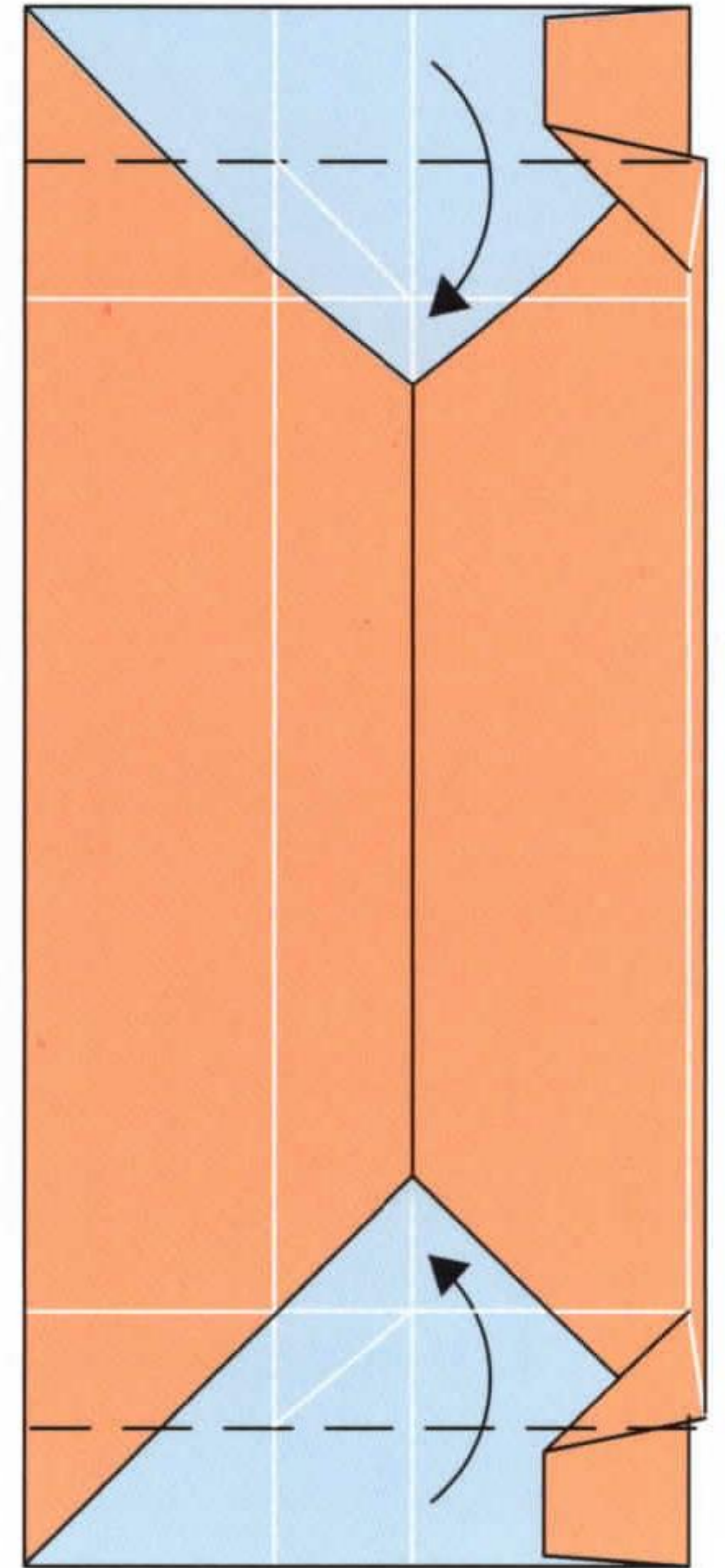

12. Valley folds

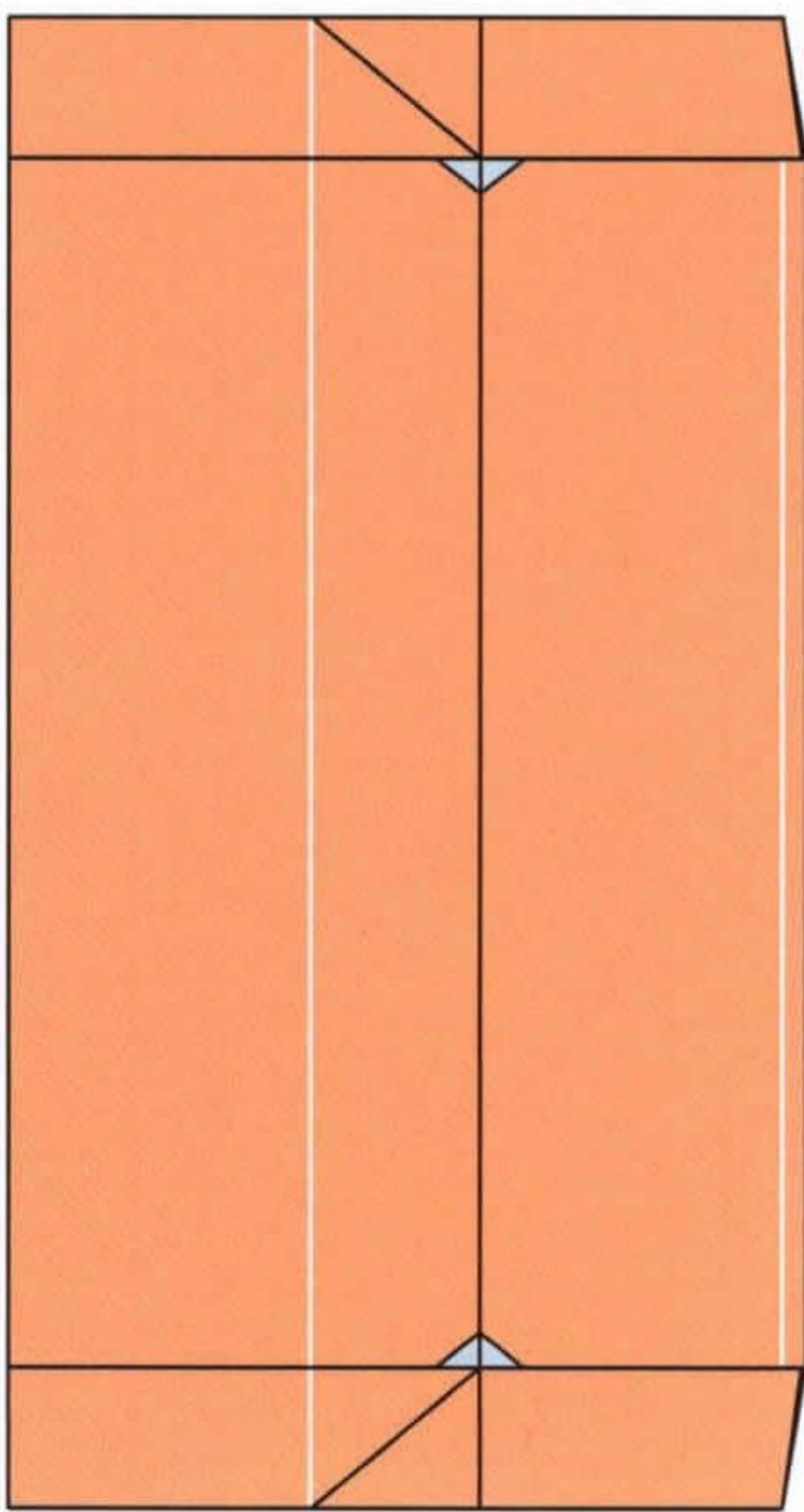

13. Crimp folds

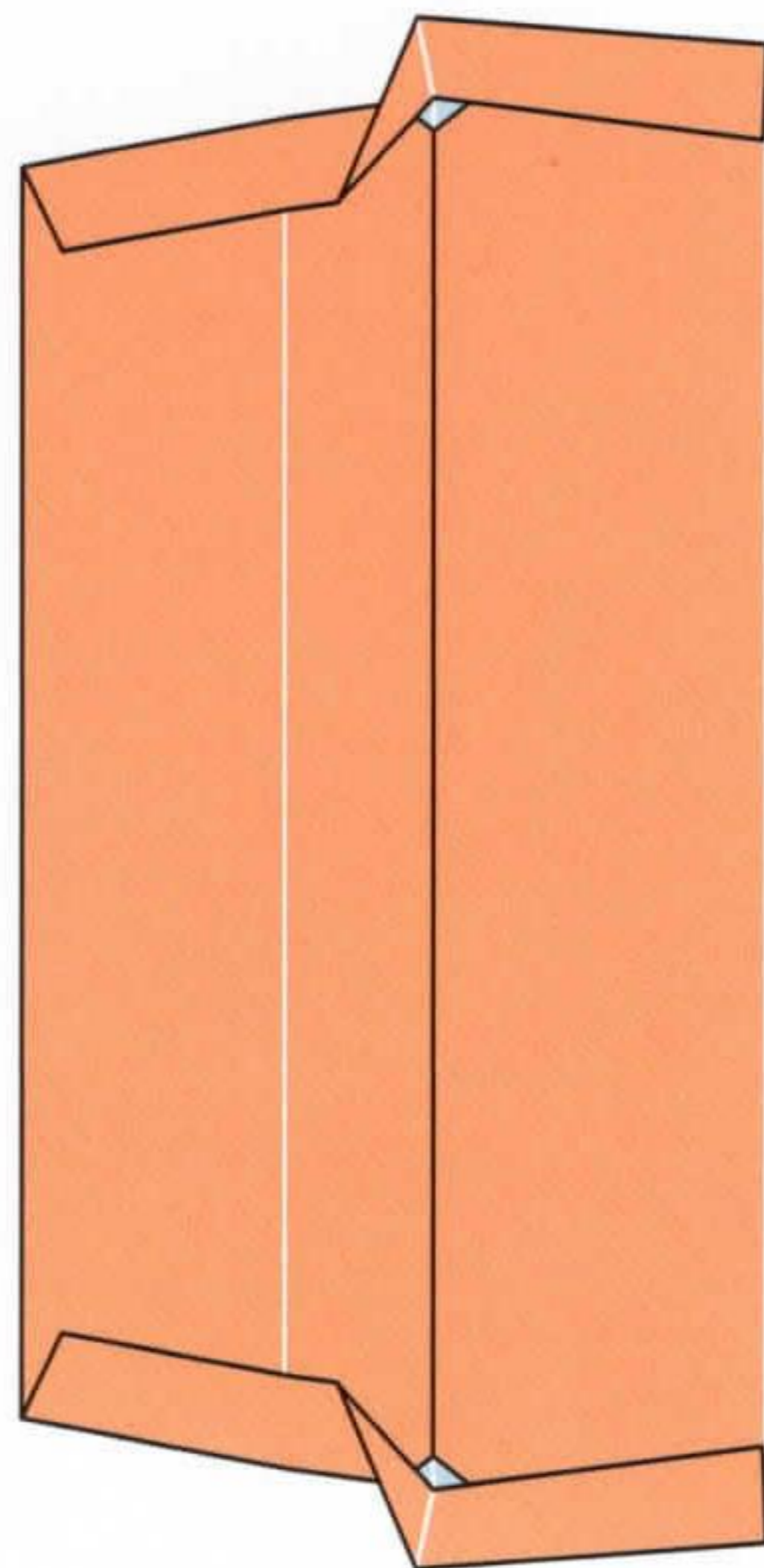

14. Before complete

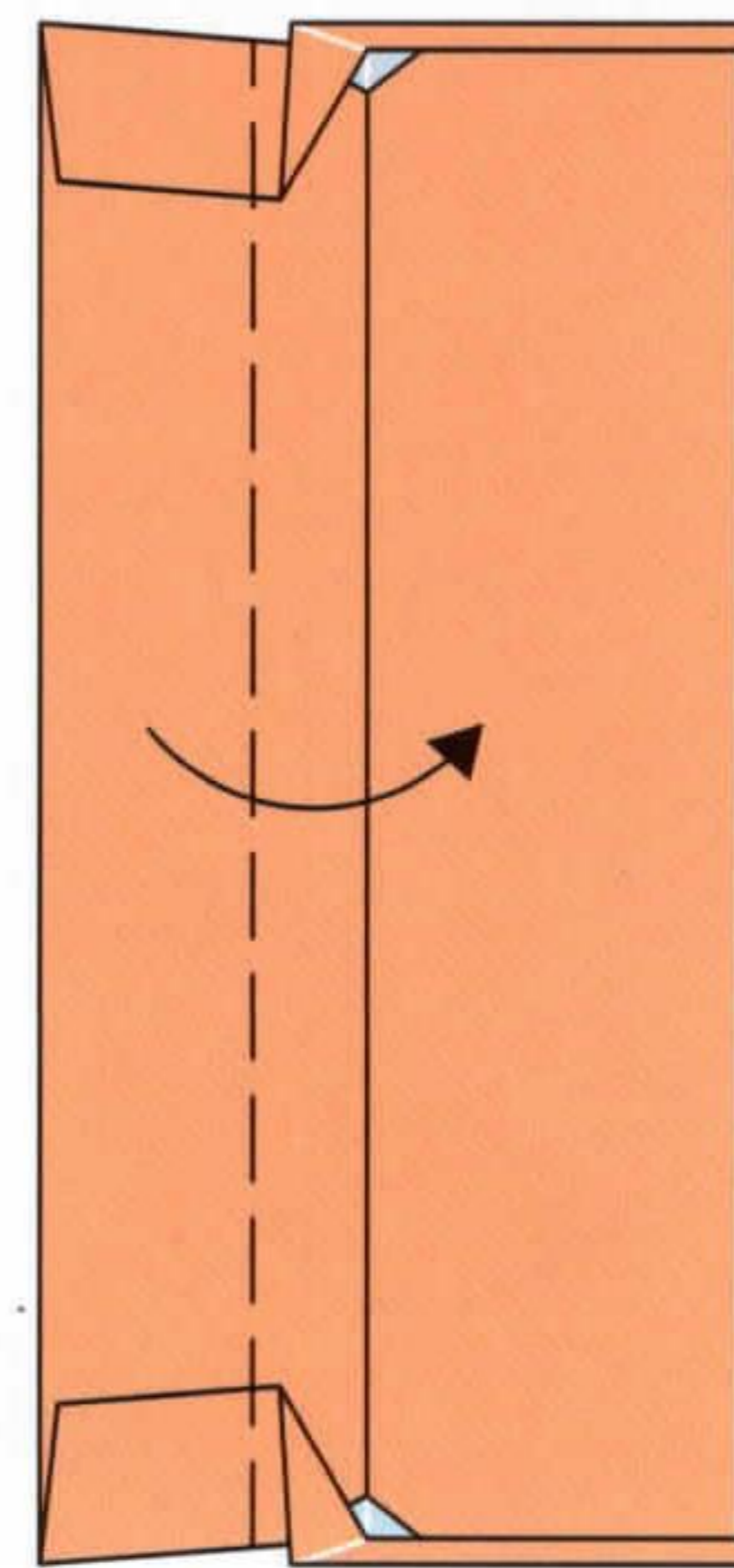

15. Close door

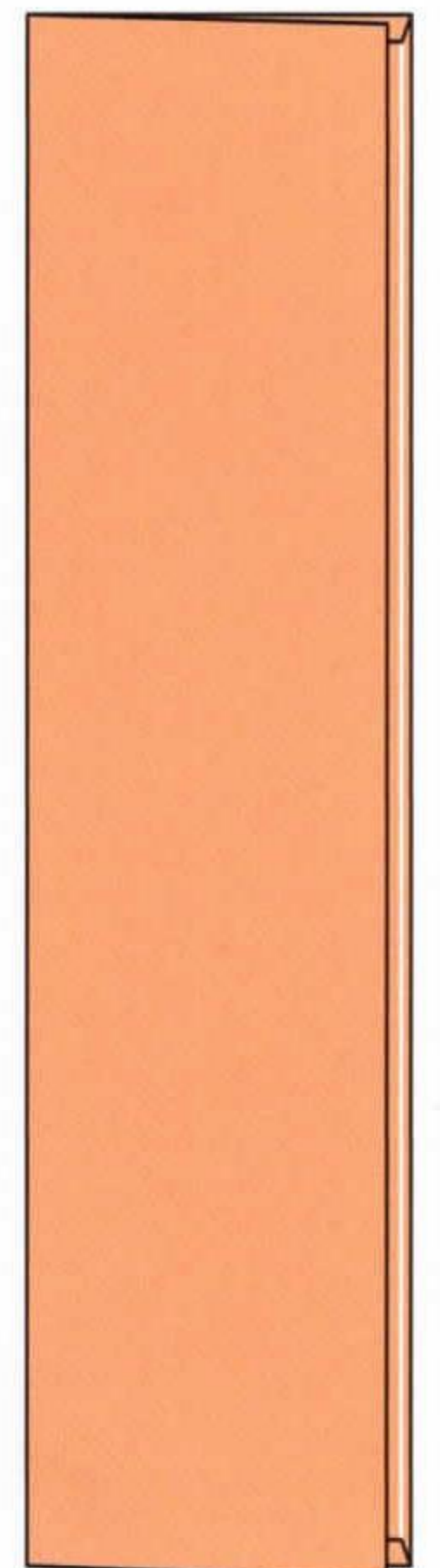

16. Completed PART 1

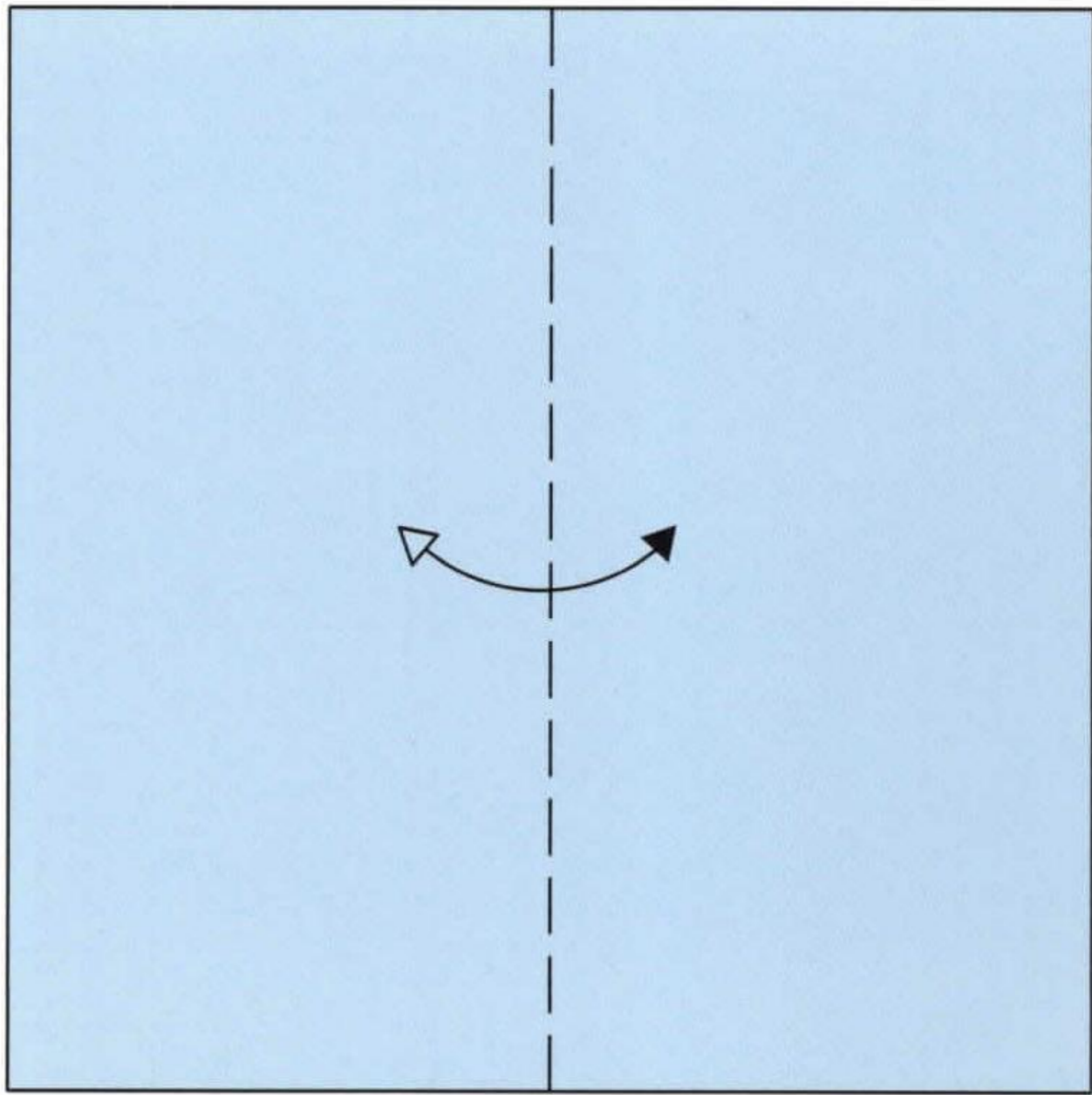

1. Valley fold and unfold

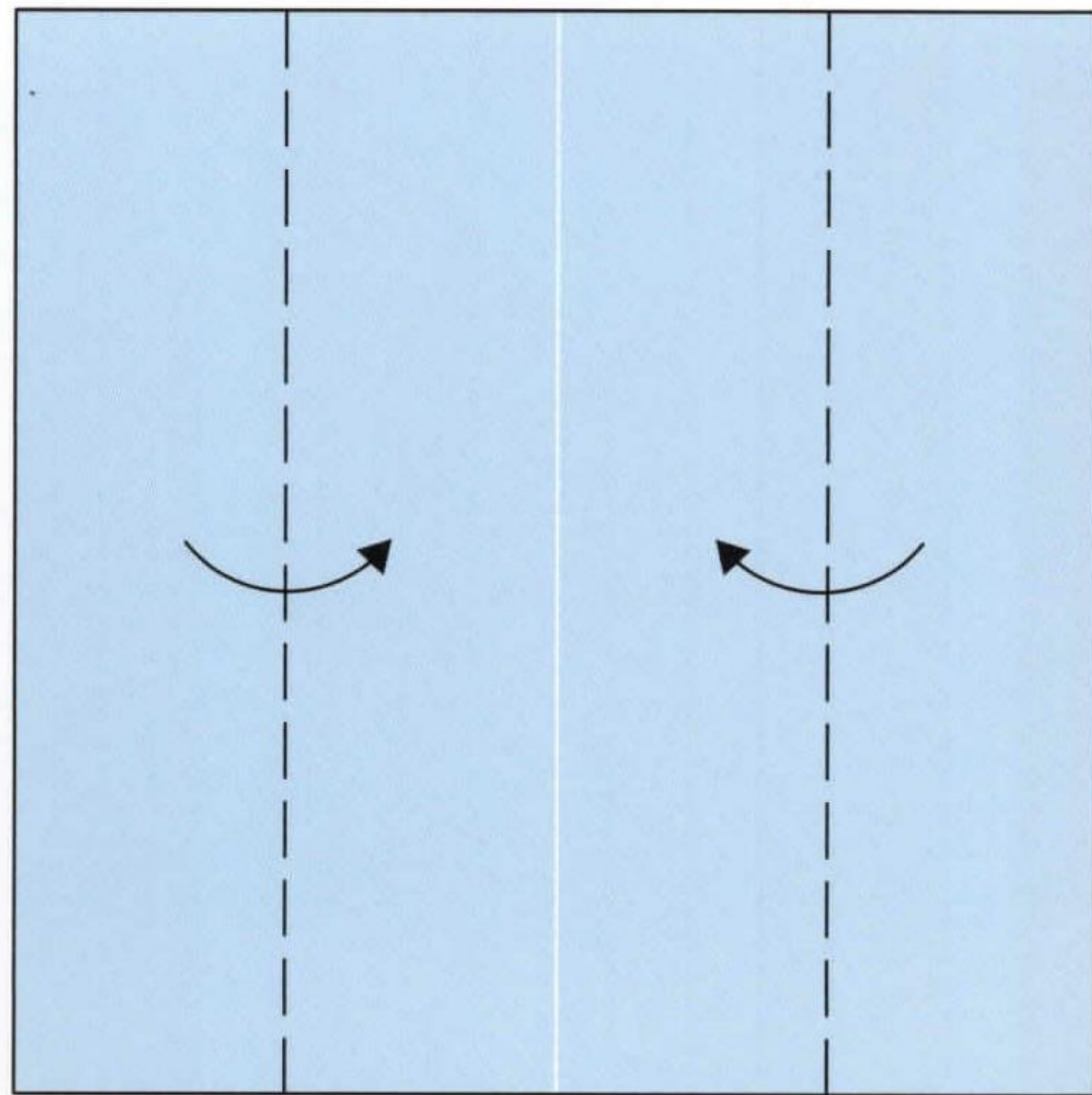

2. Valley folds

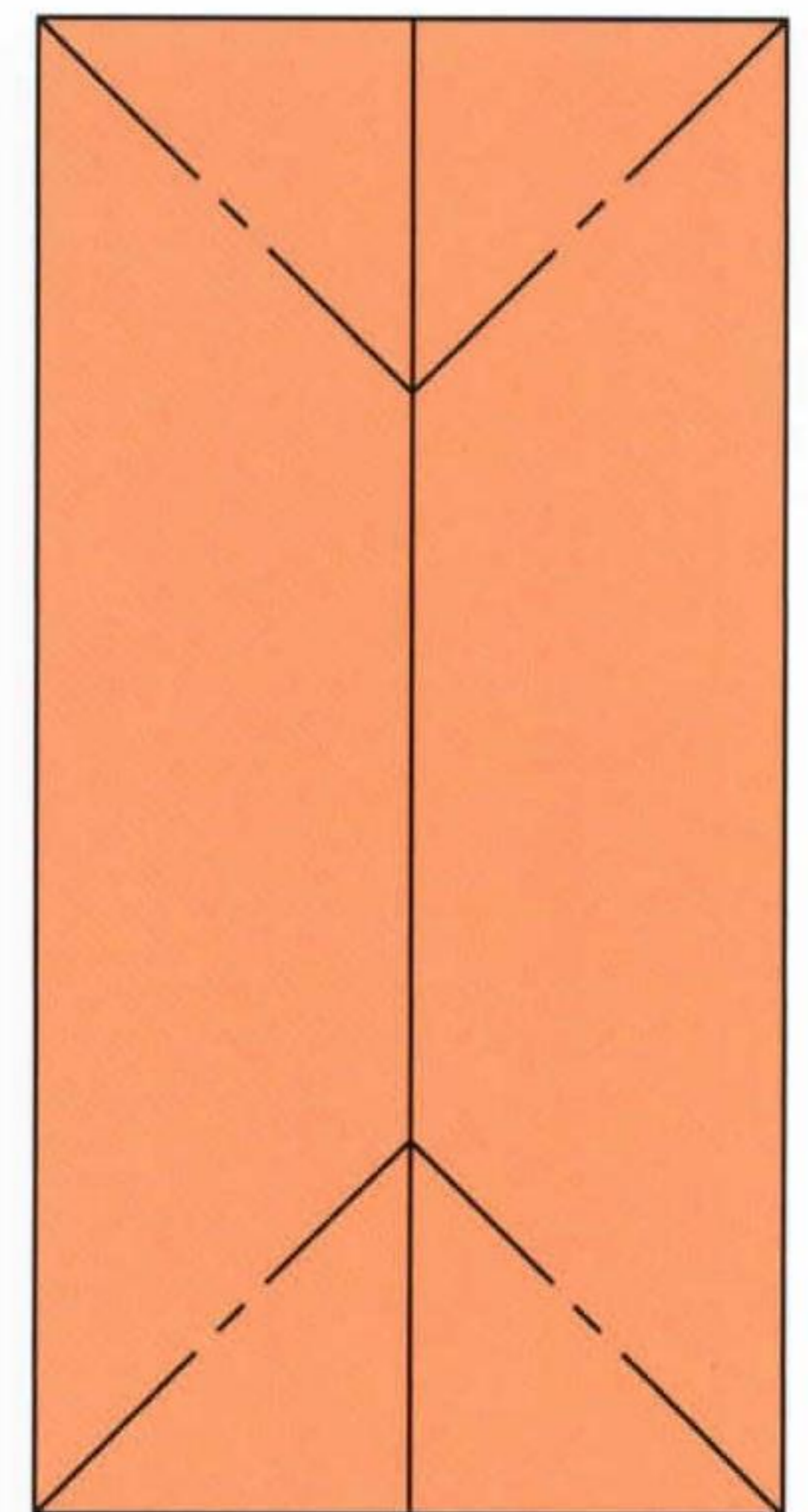

3. Mountain folds

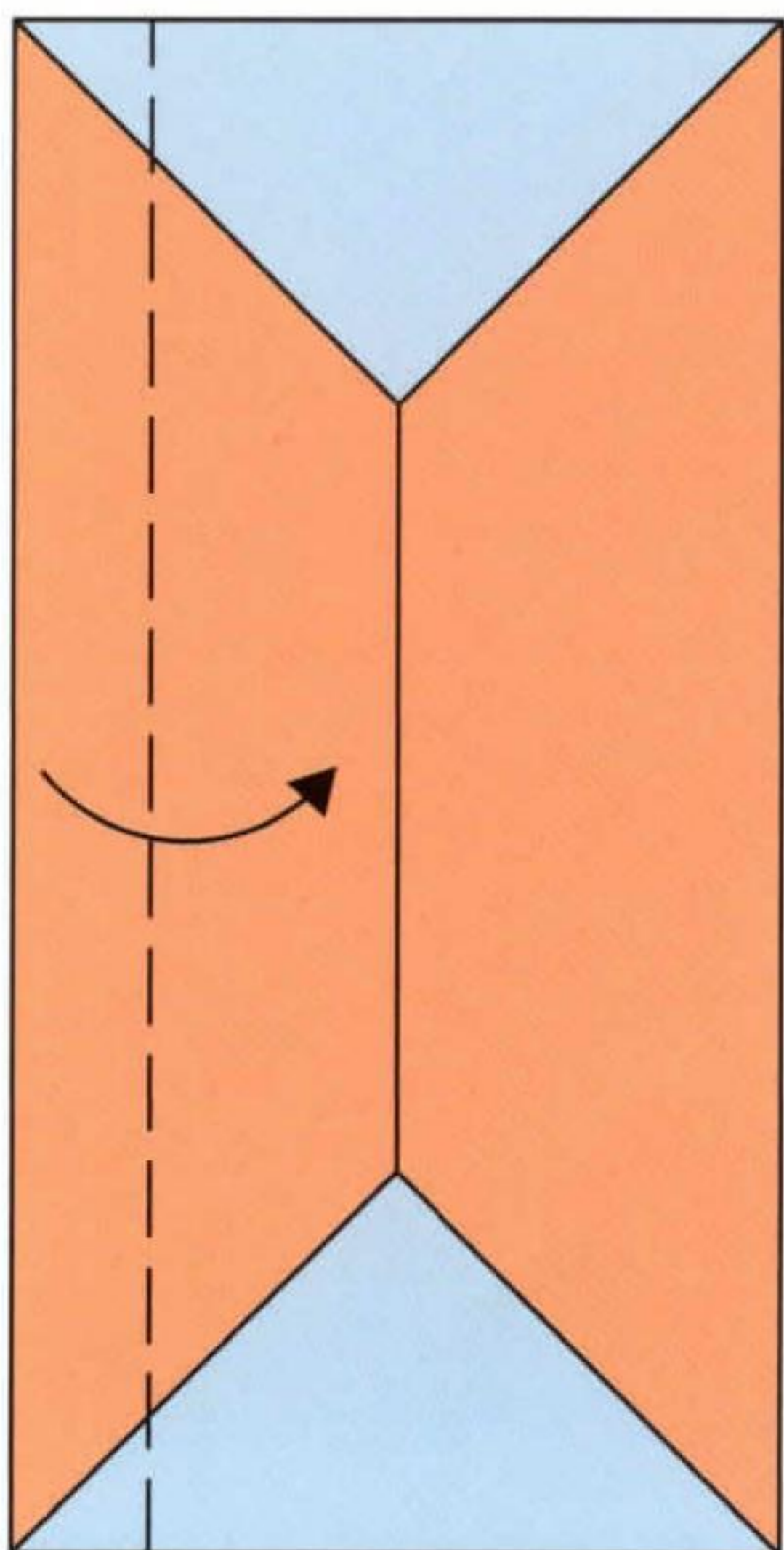

4. Valley fold

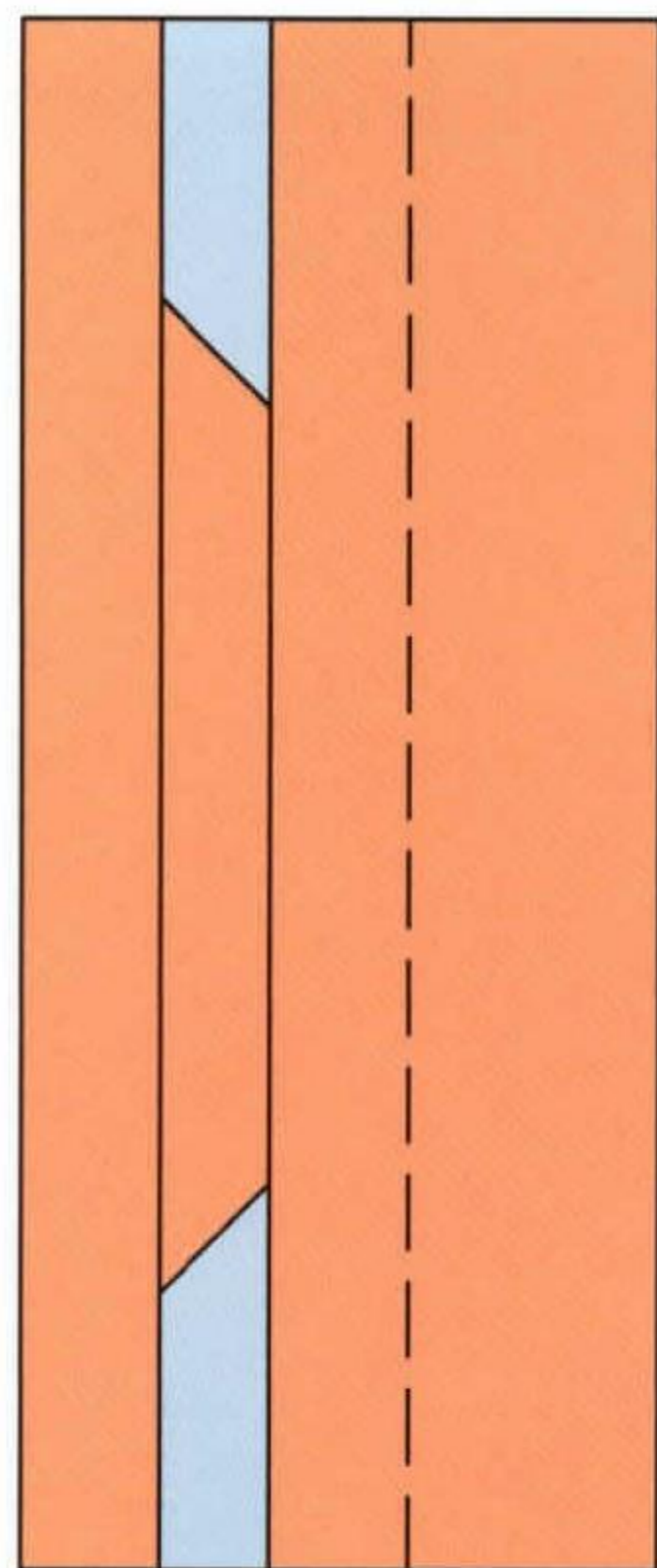

5. Valley fold

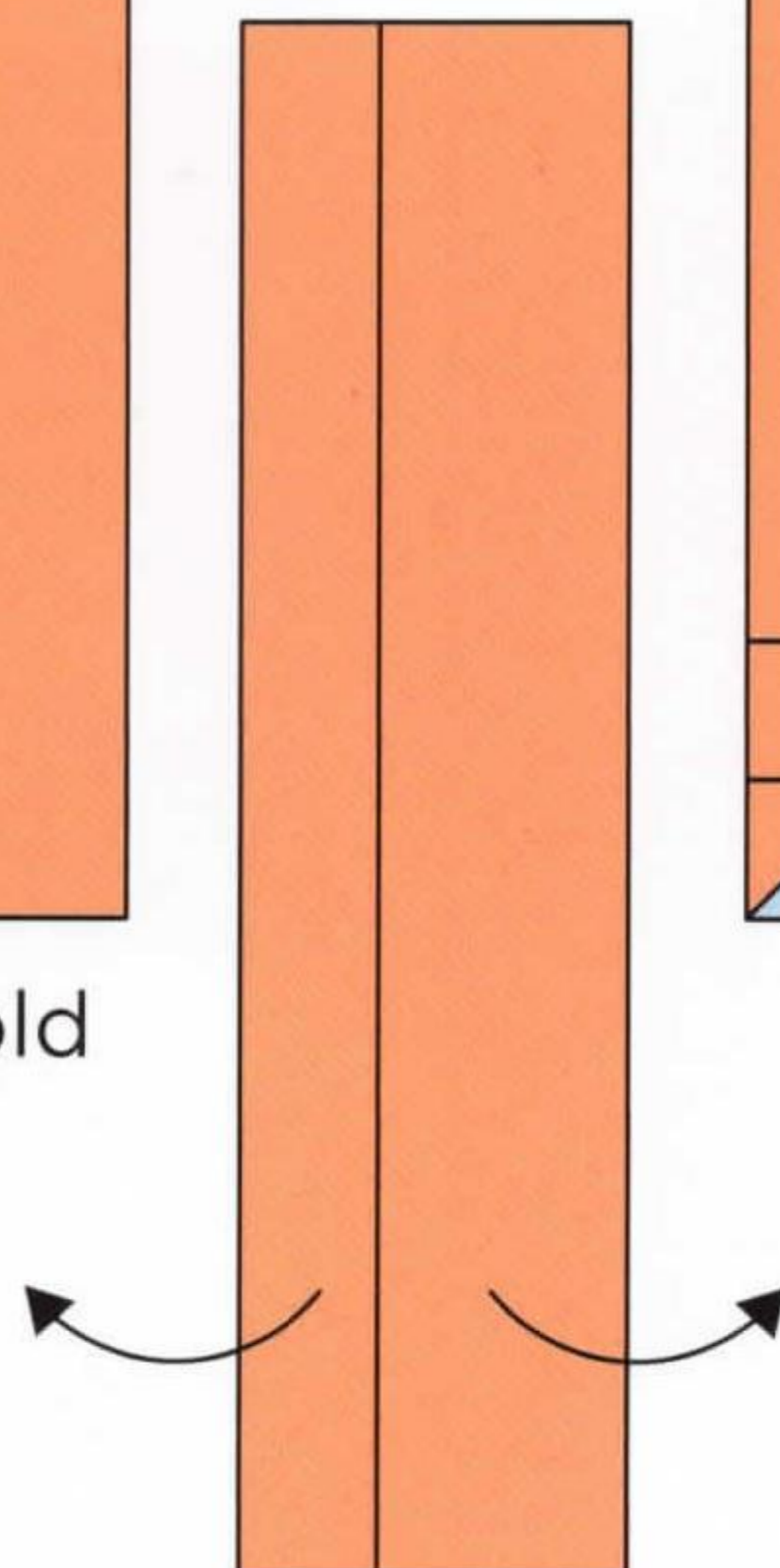

6. Valley folds

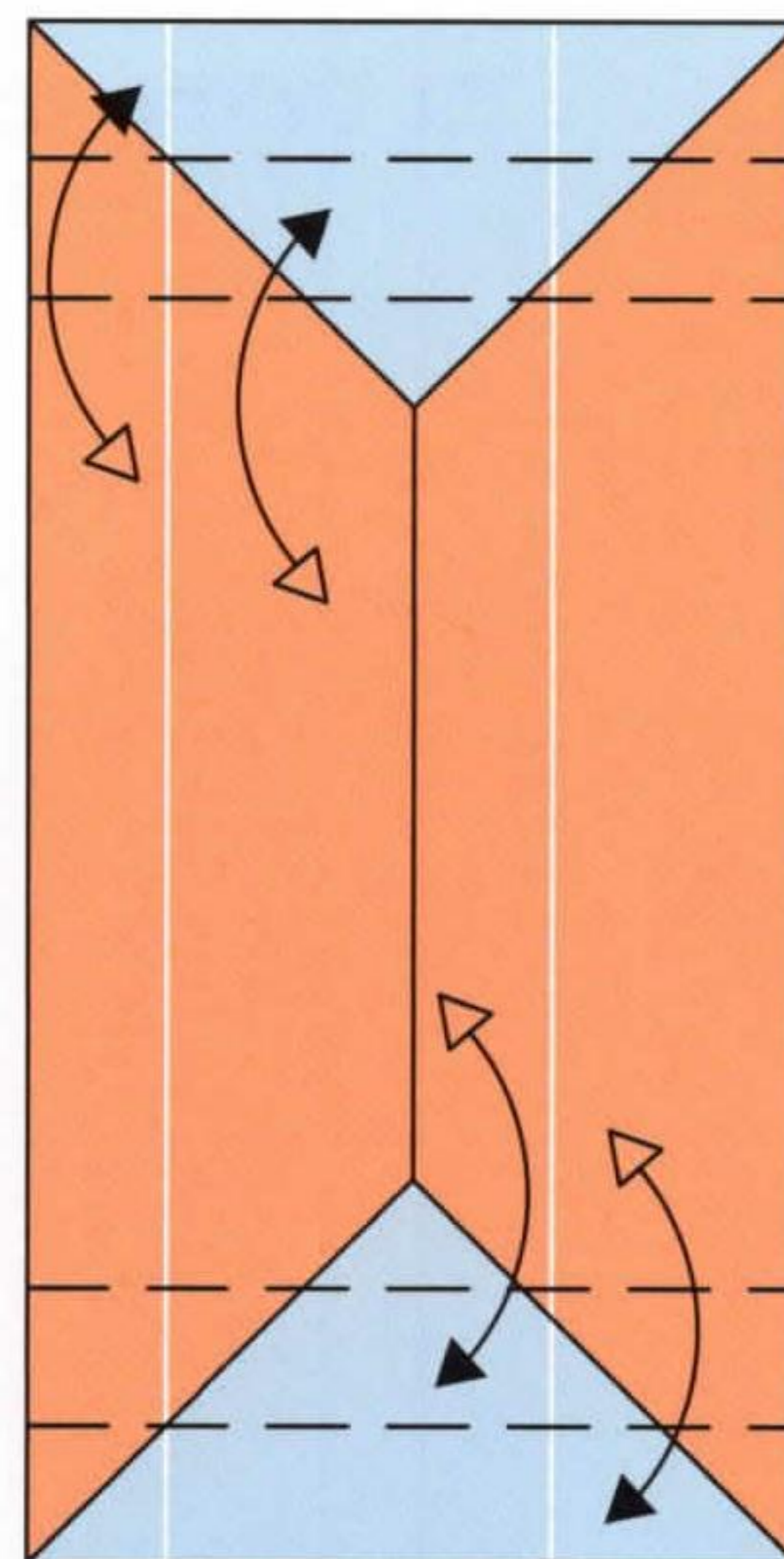

7. Valley folds unfold

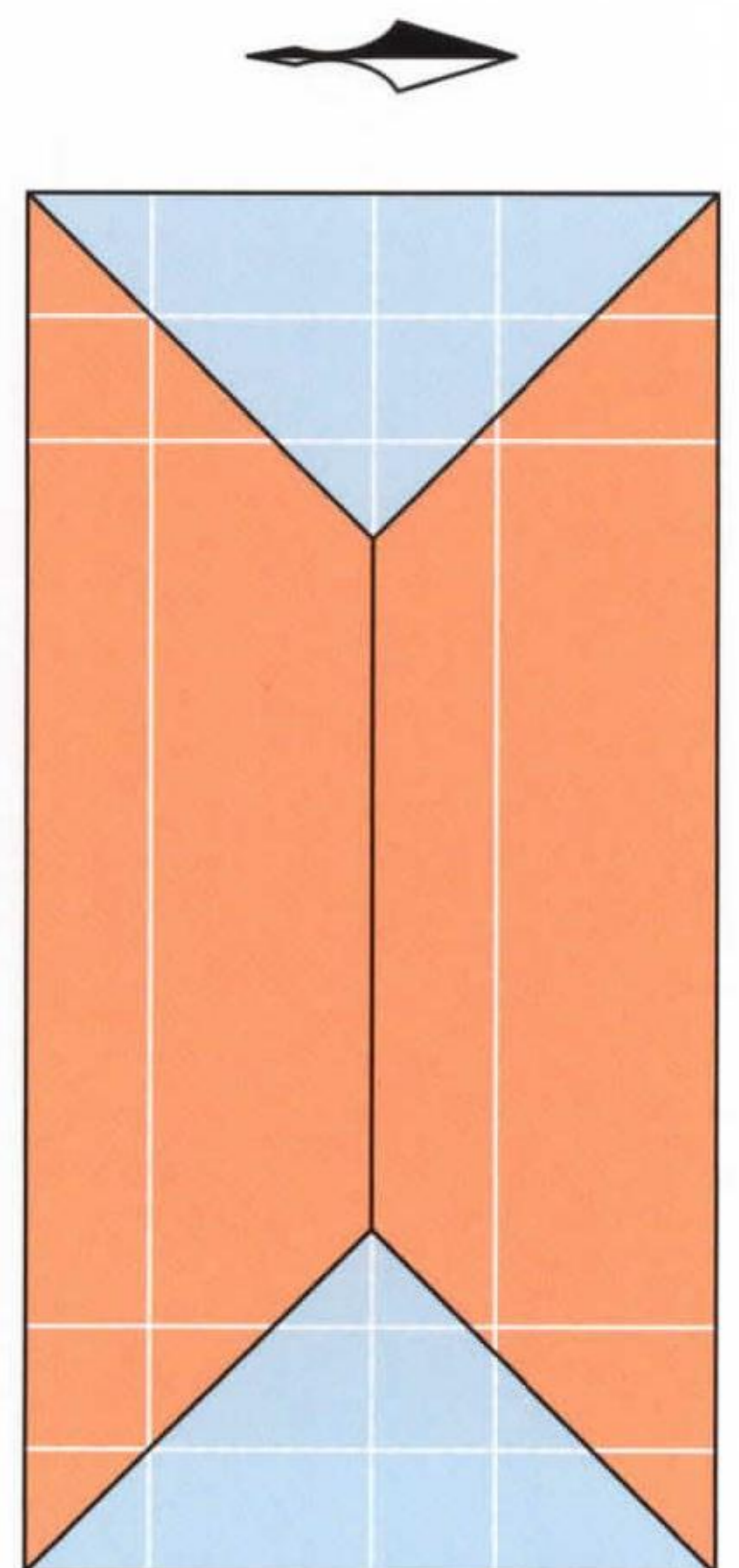

8. Scale-up

6

bathroom

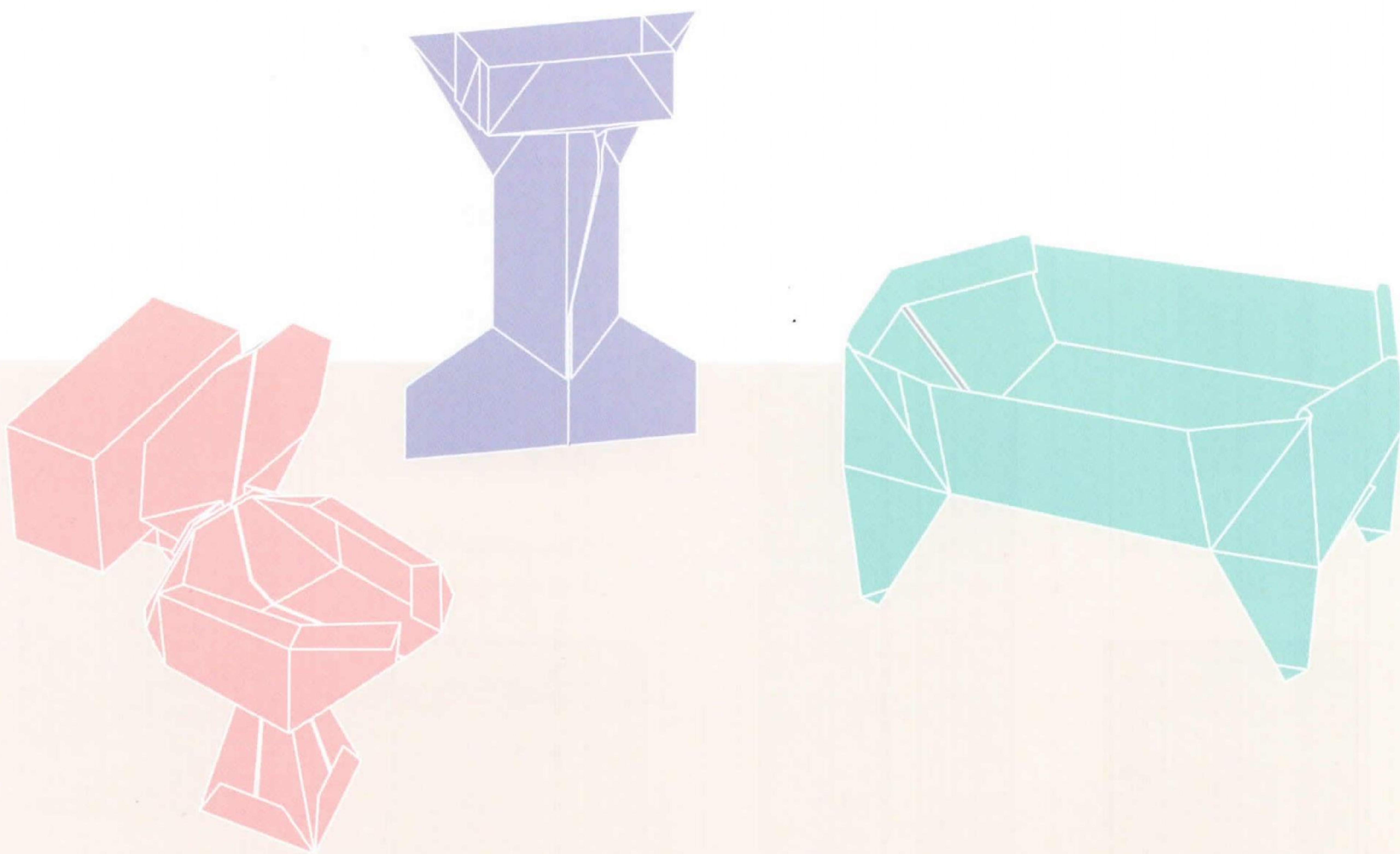

bathtub | sink (basin) | toilet

▶ bathtub

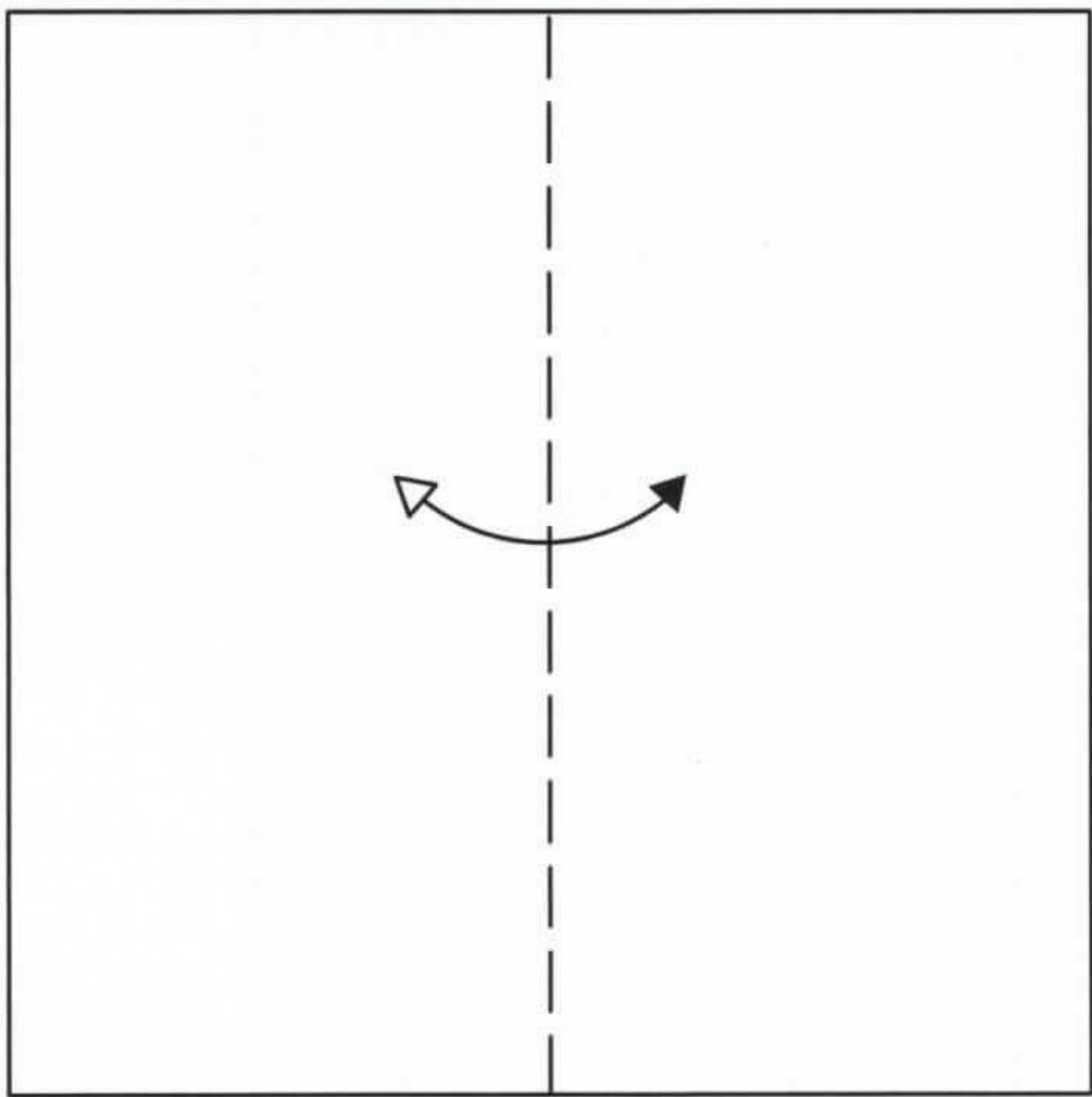

1. Valley fold and unfold

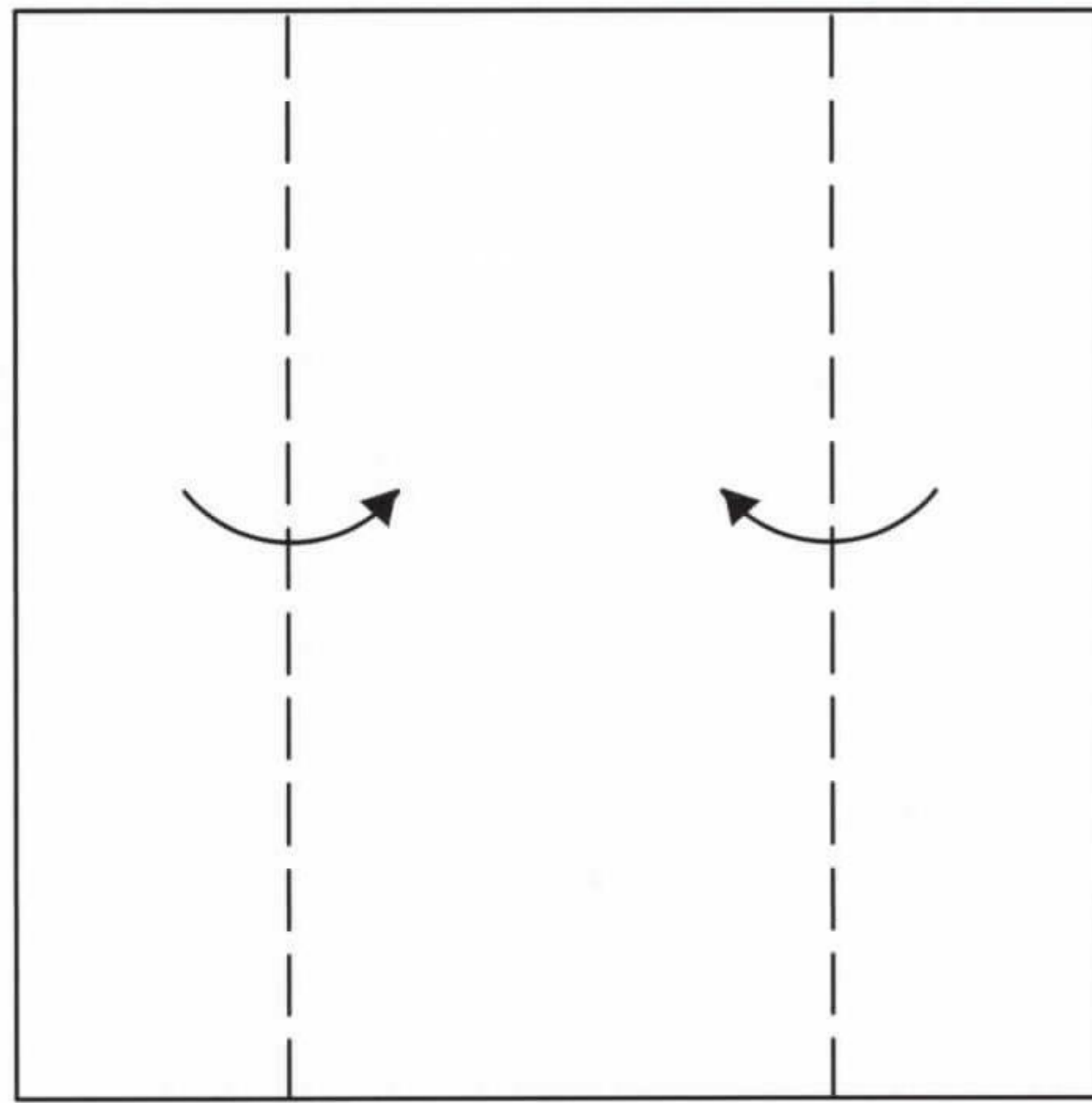

2. Valley folds

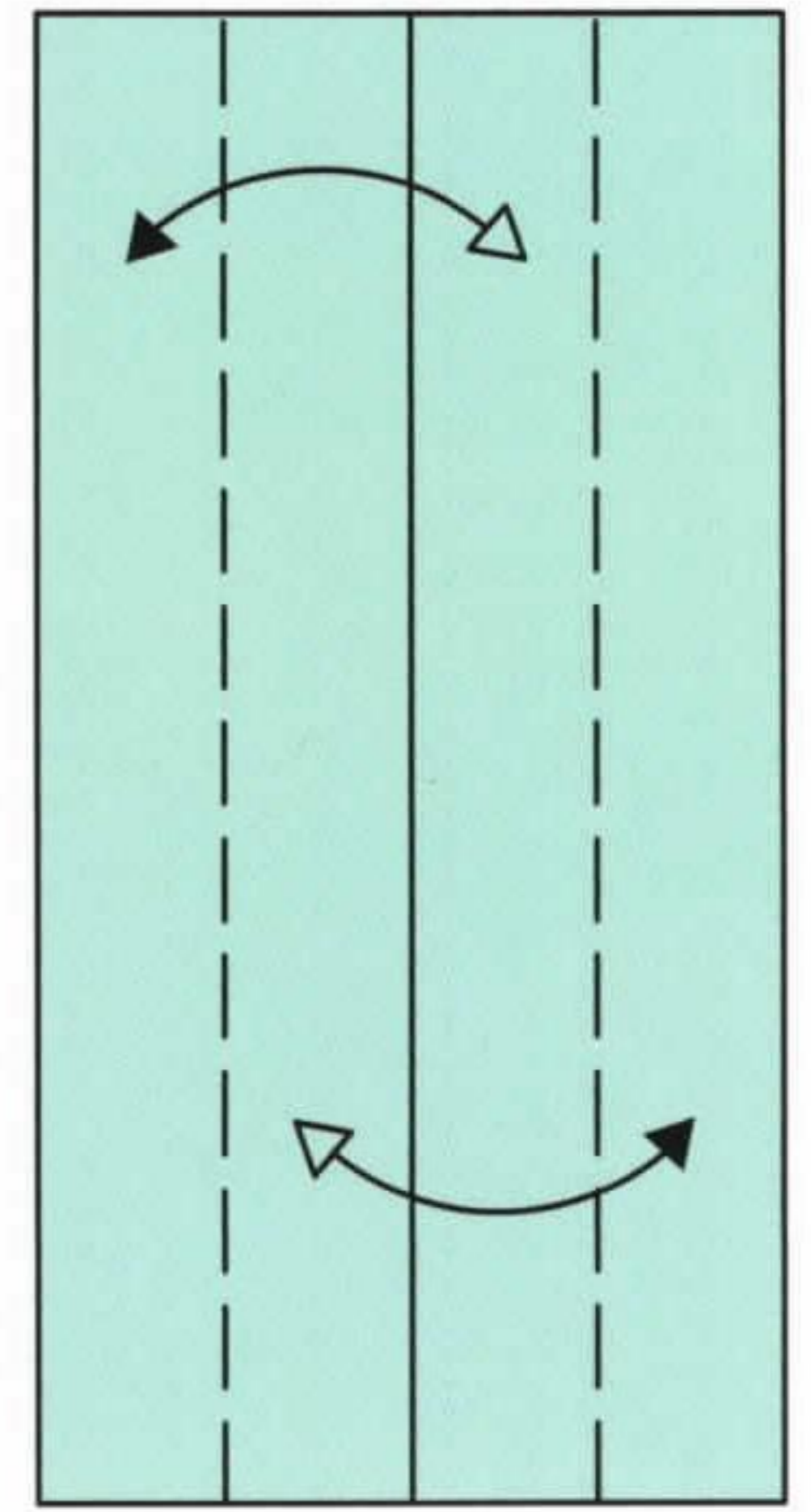

3. Valley folds and unfold

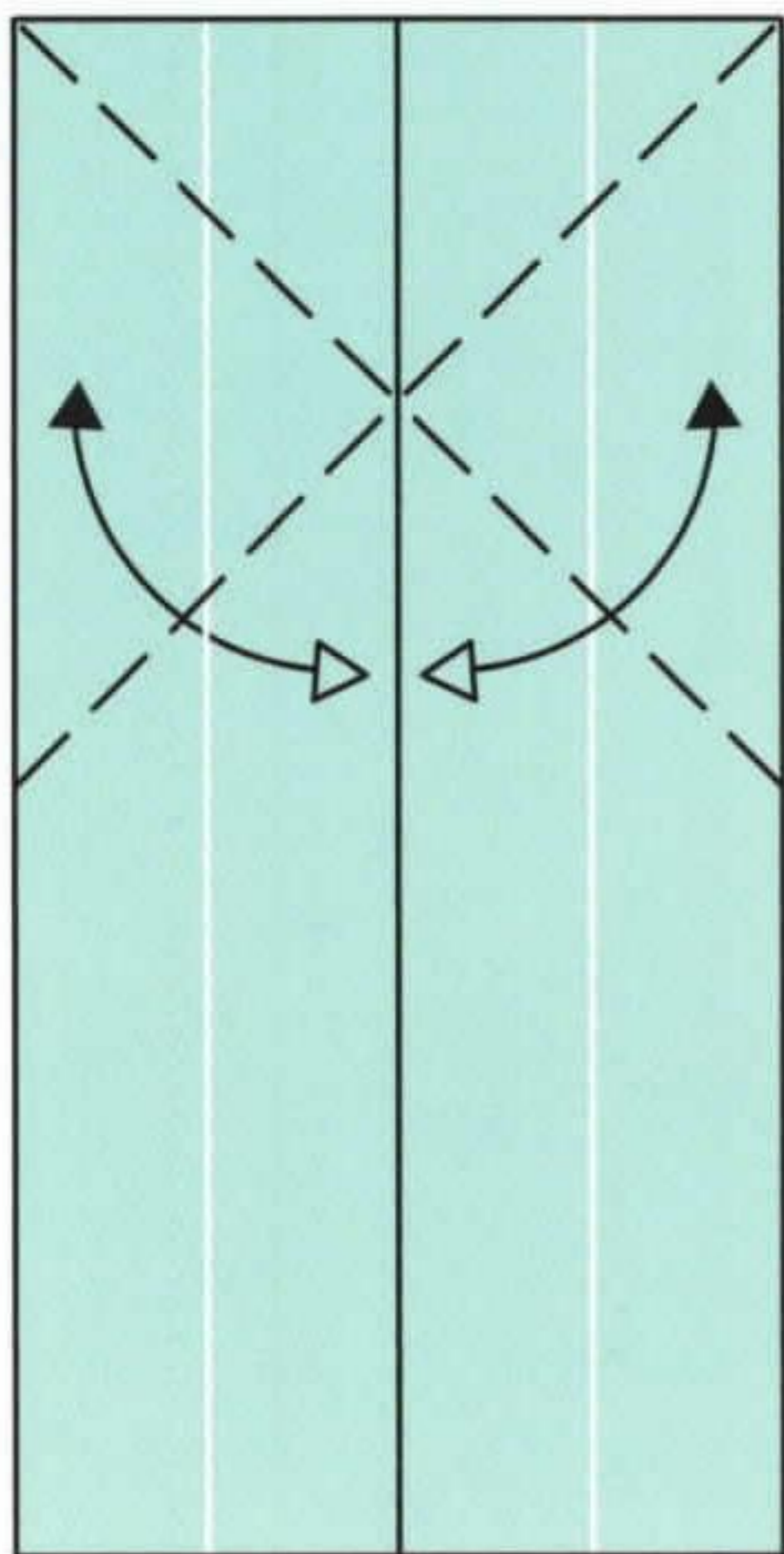

4. Valley folds and unfold

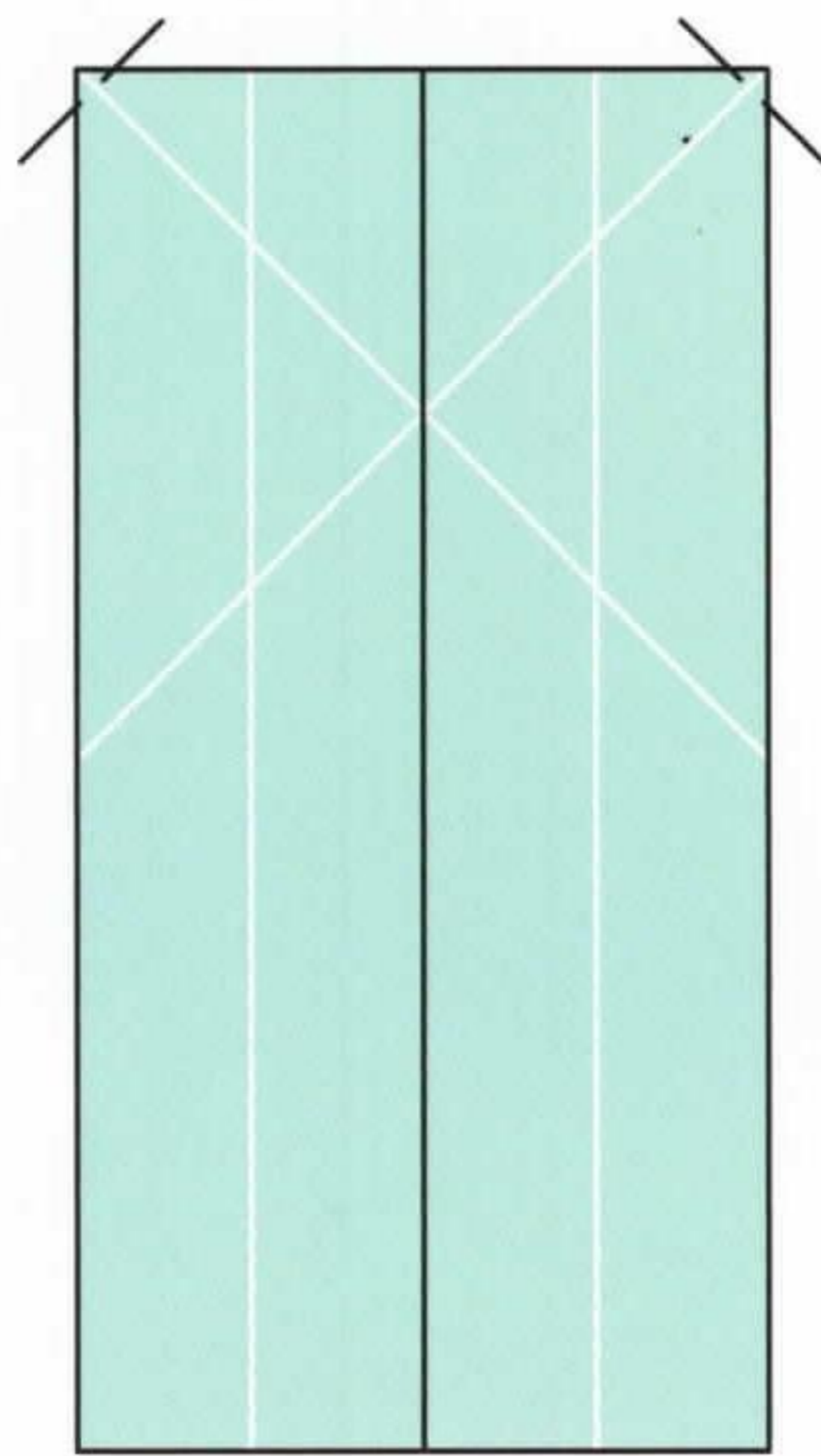

5. Valley folds

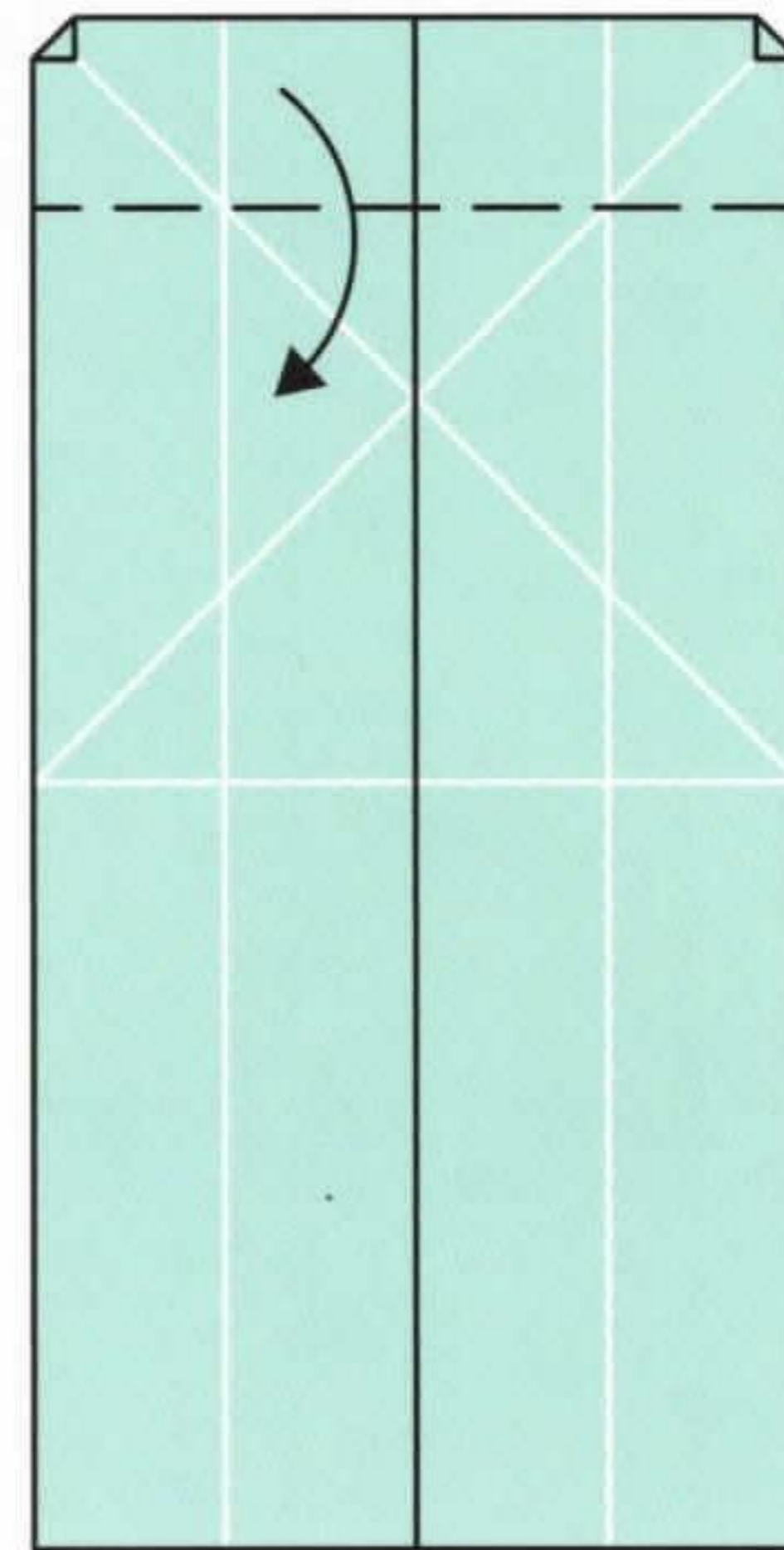

6. Valley fold

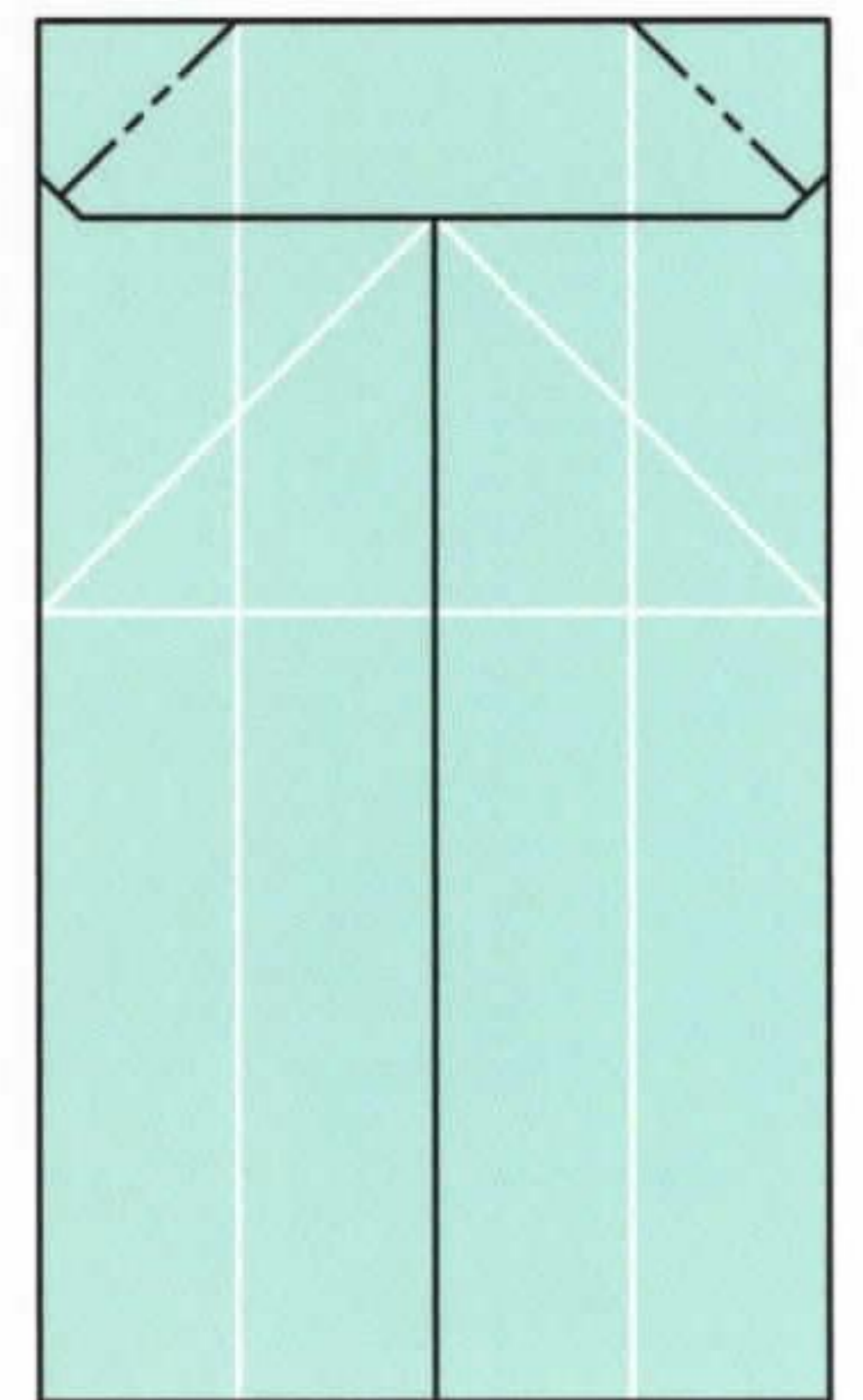

7. Inside reverse folds

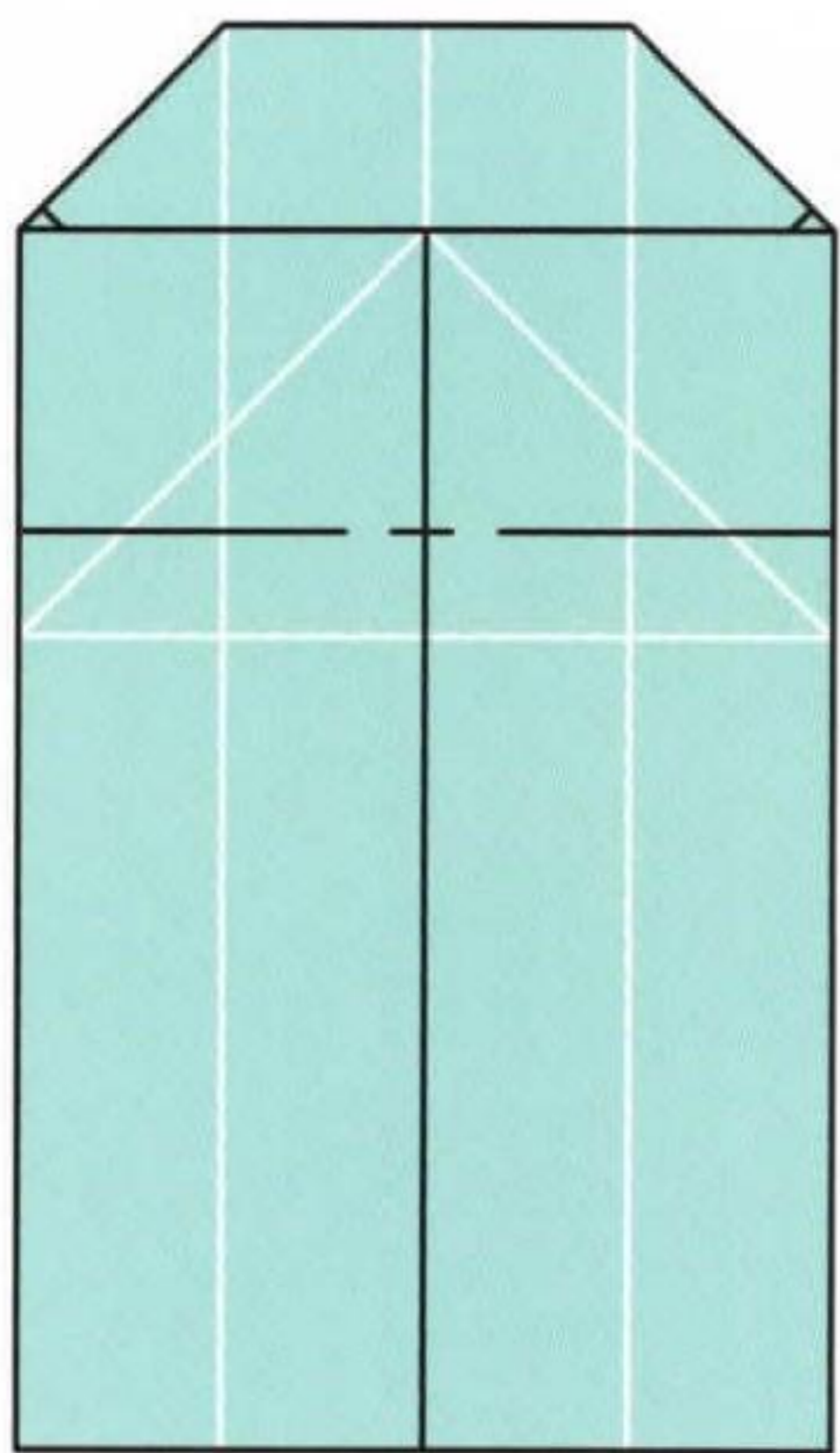

8. Mountain fold

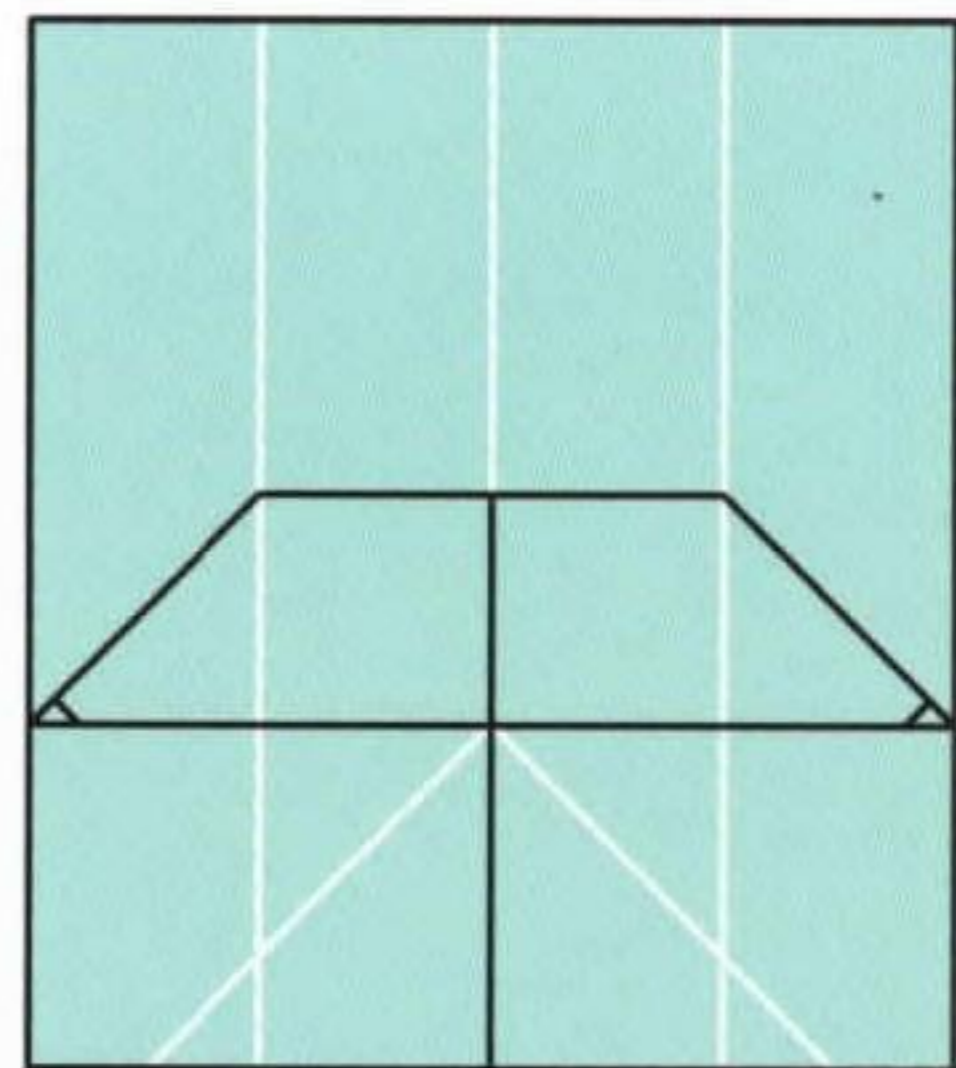

9. Rotate

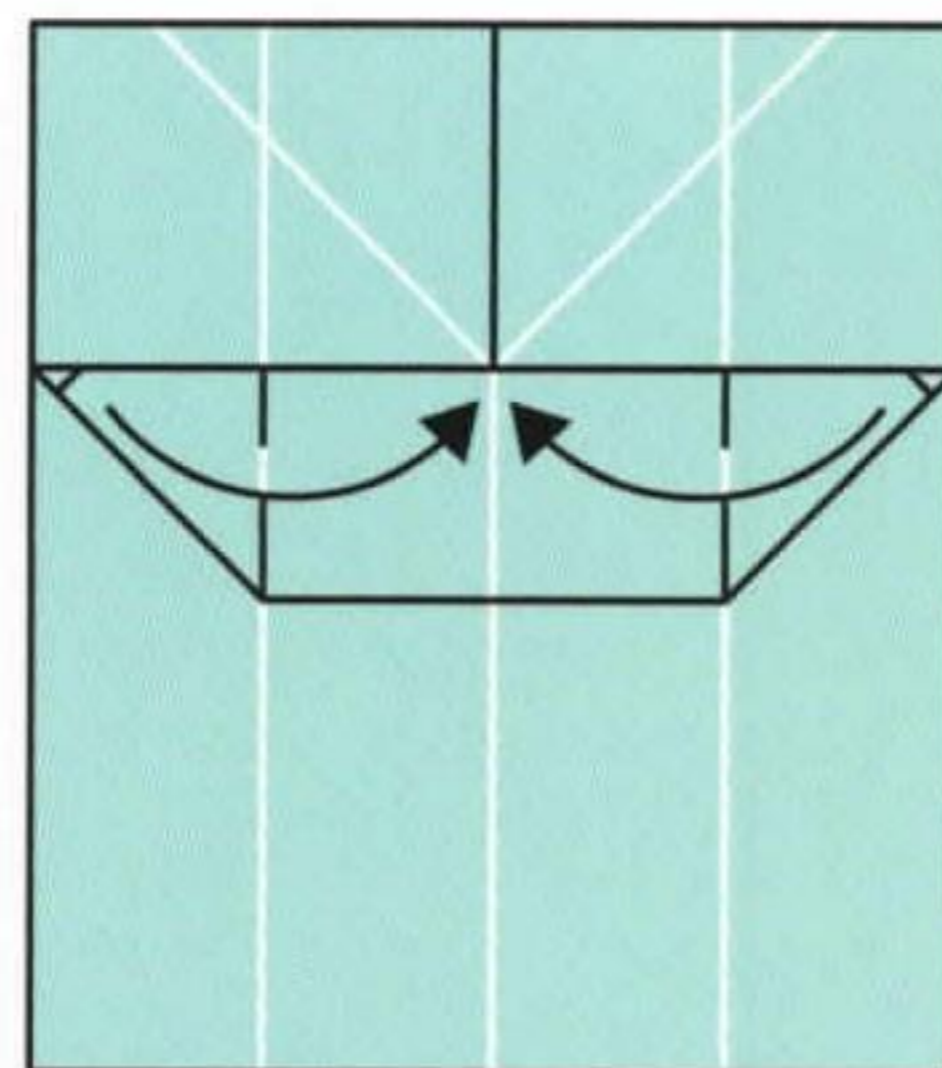

10. Valley folds

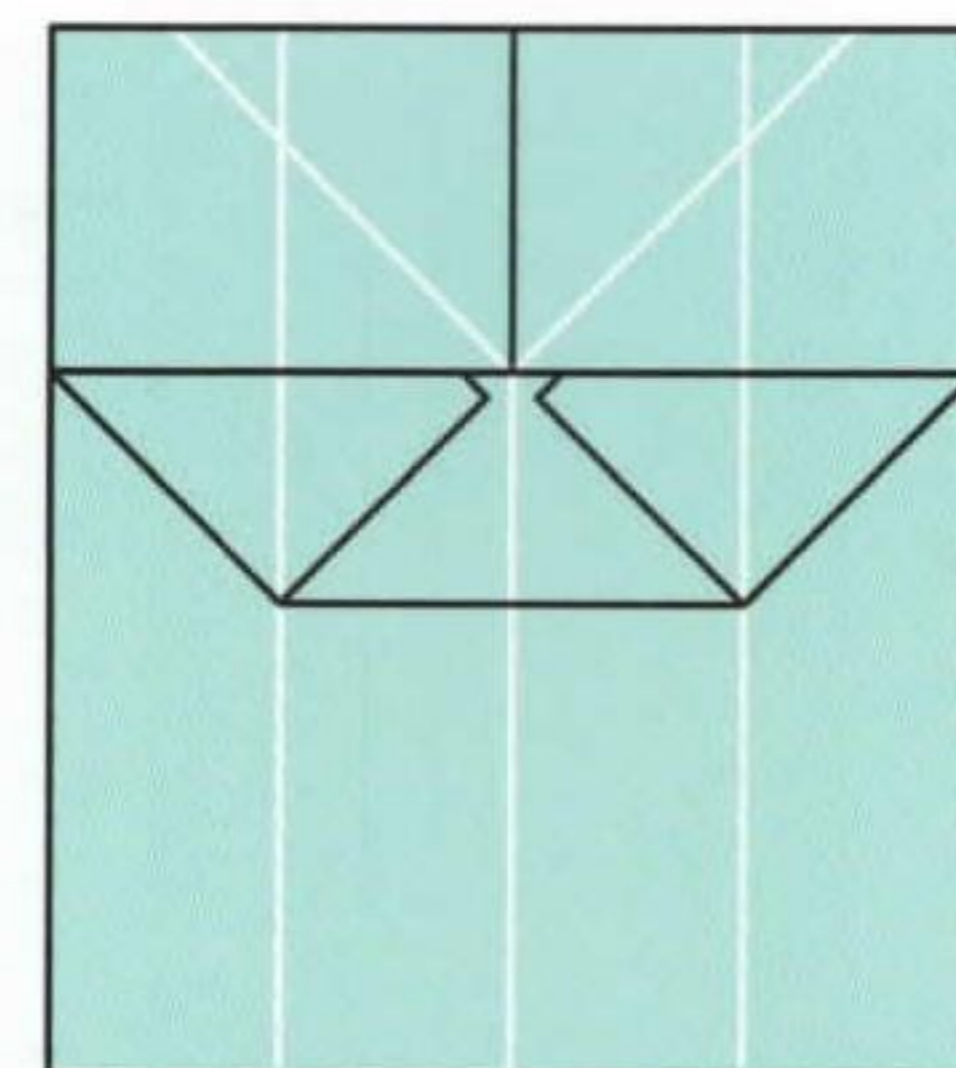

11. Turn over

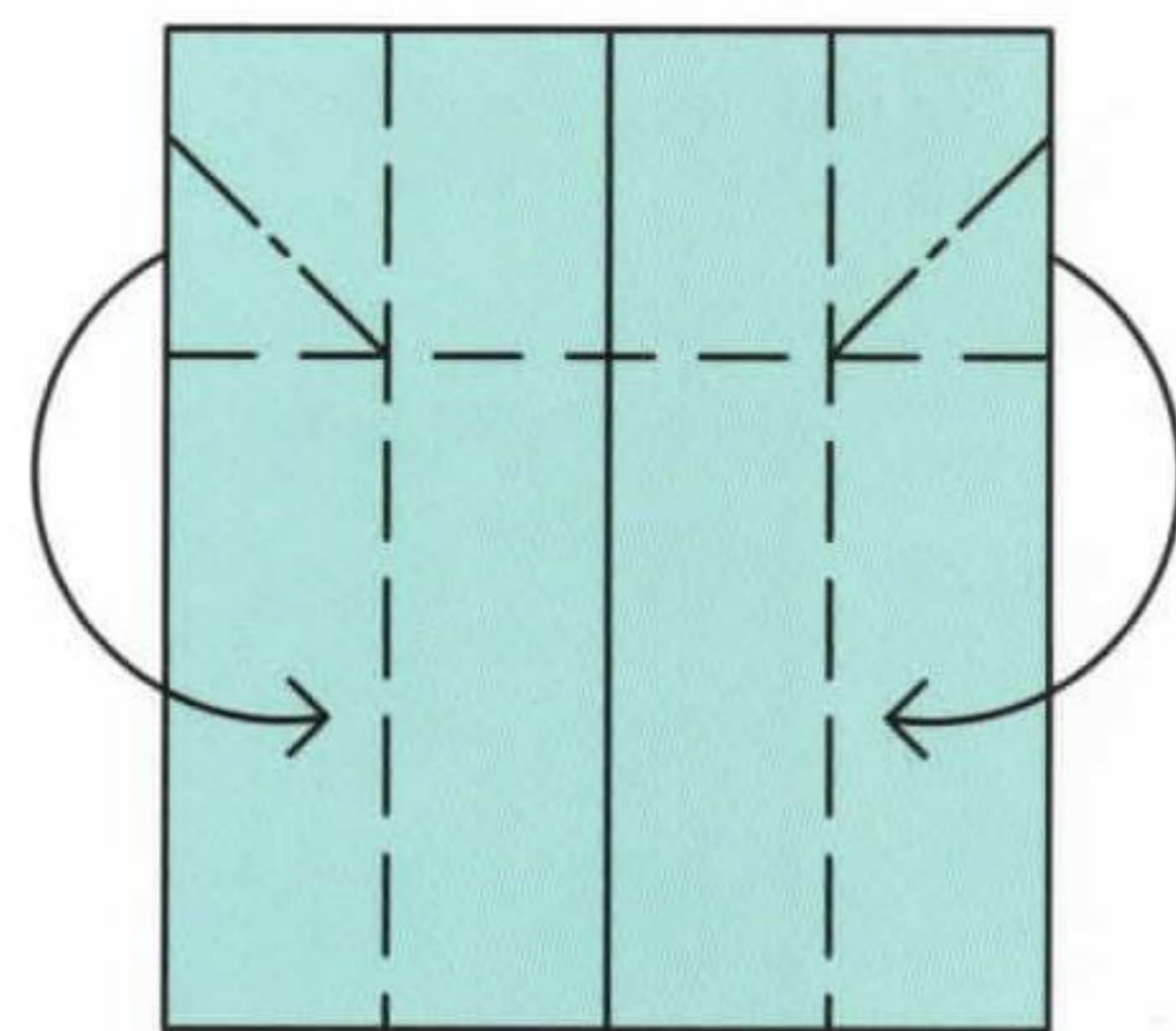

12. Valley folds and crimp folds

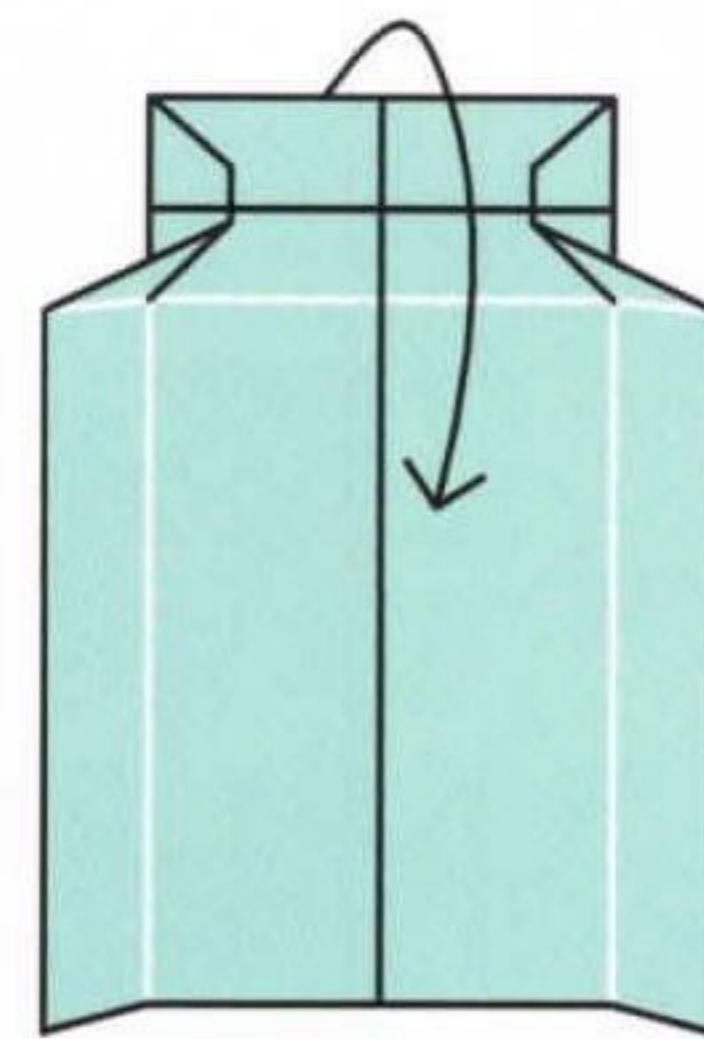

13. Valley fold the edge inside to lock

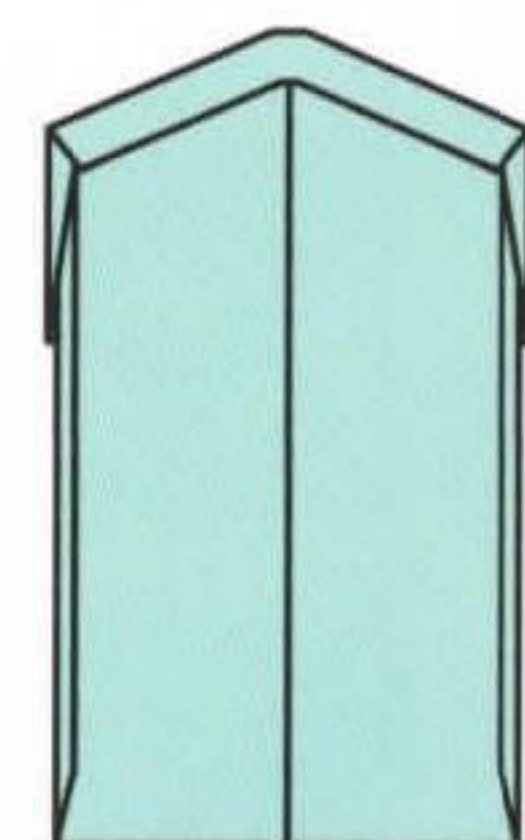

14. Completed PART 1

ASSEMBLY

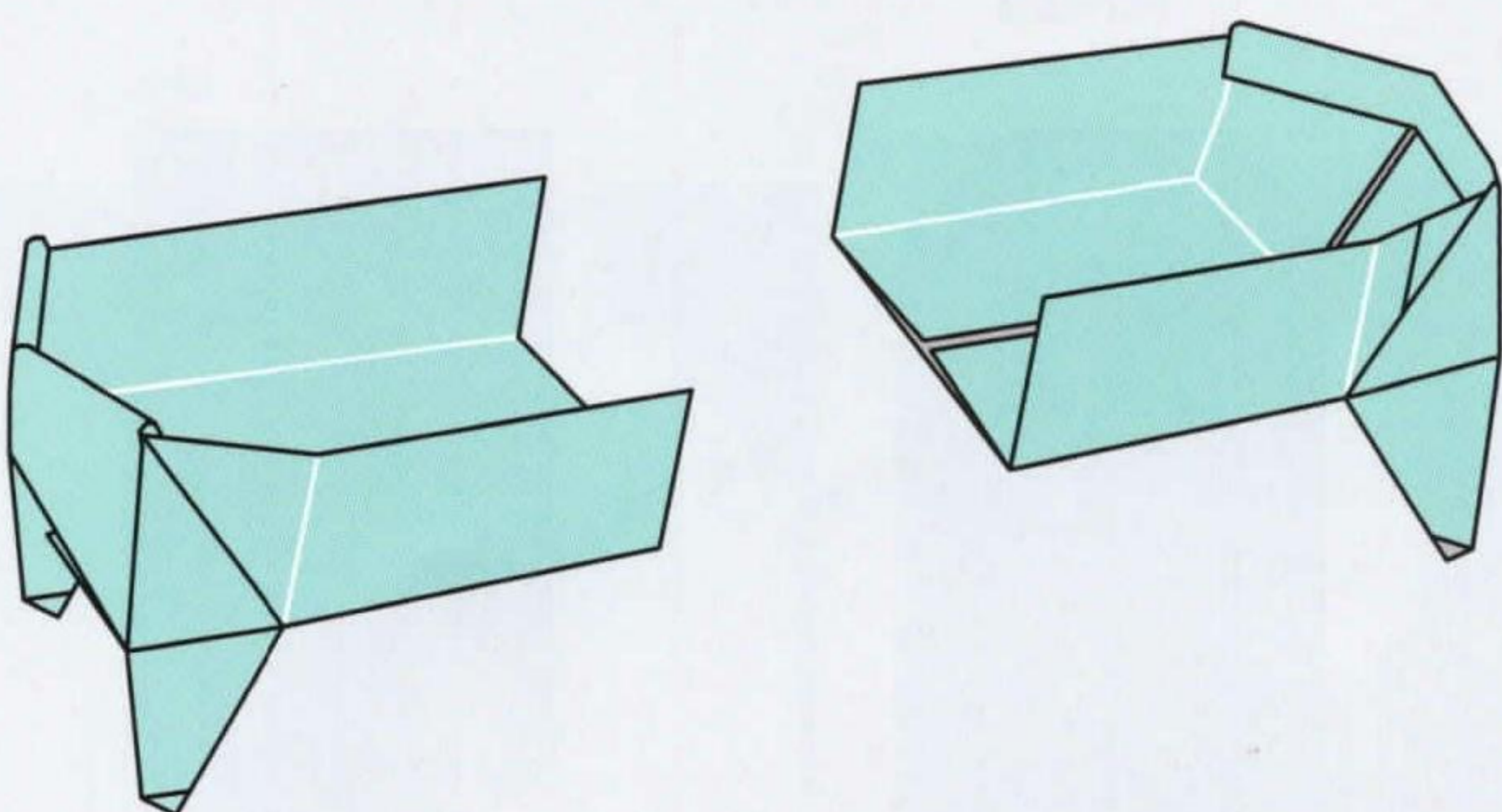

1. Make another for final assembly, then insert as indicated

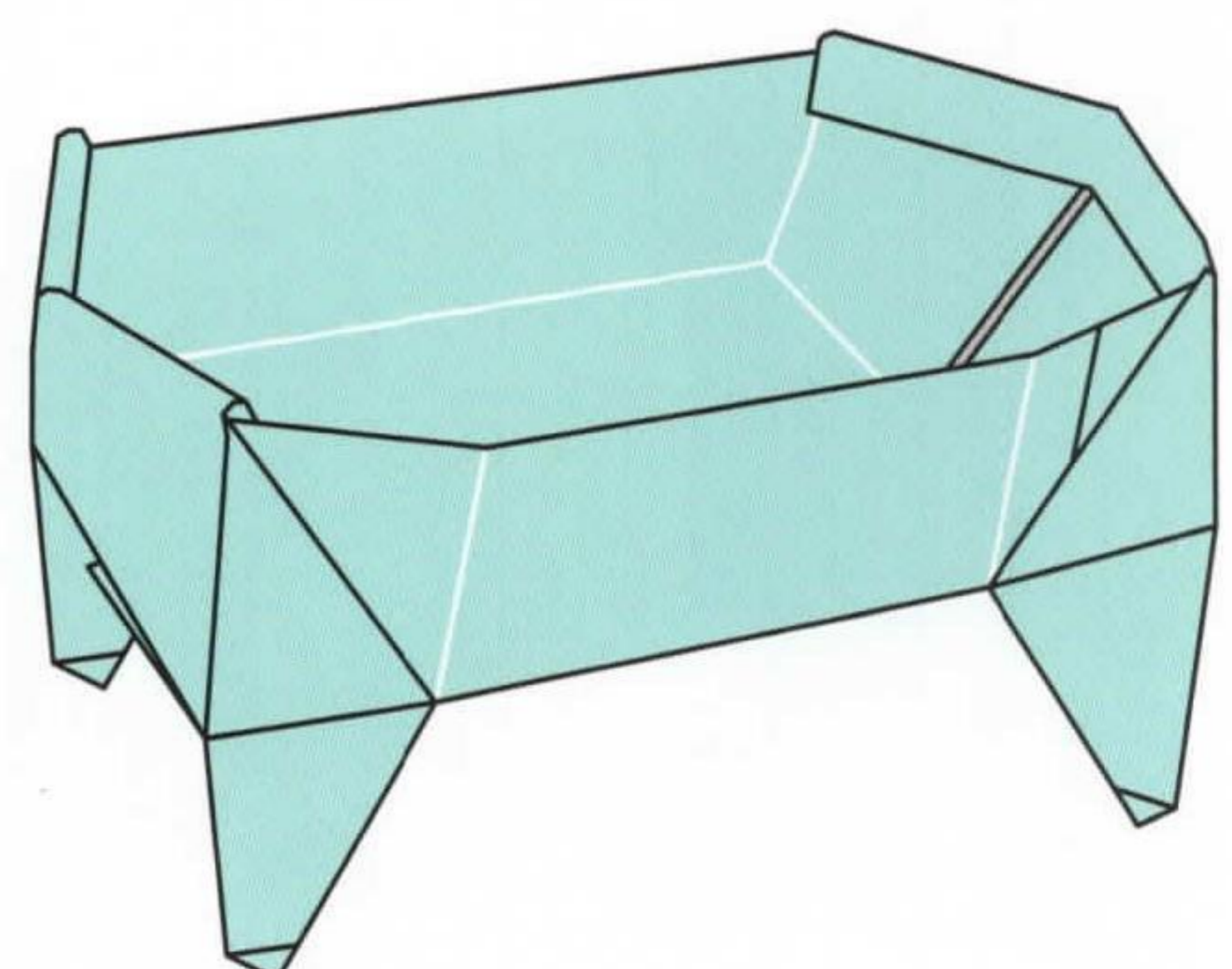

2. Completed BATHTUB

➤ sink (basin)

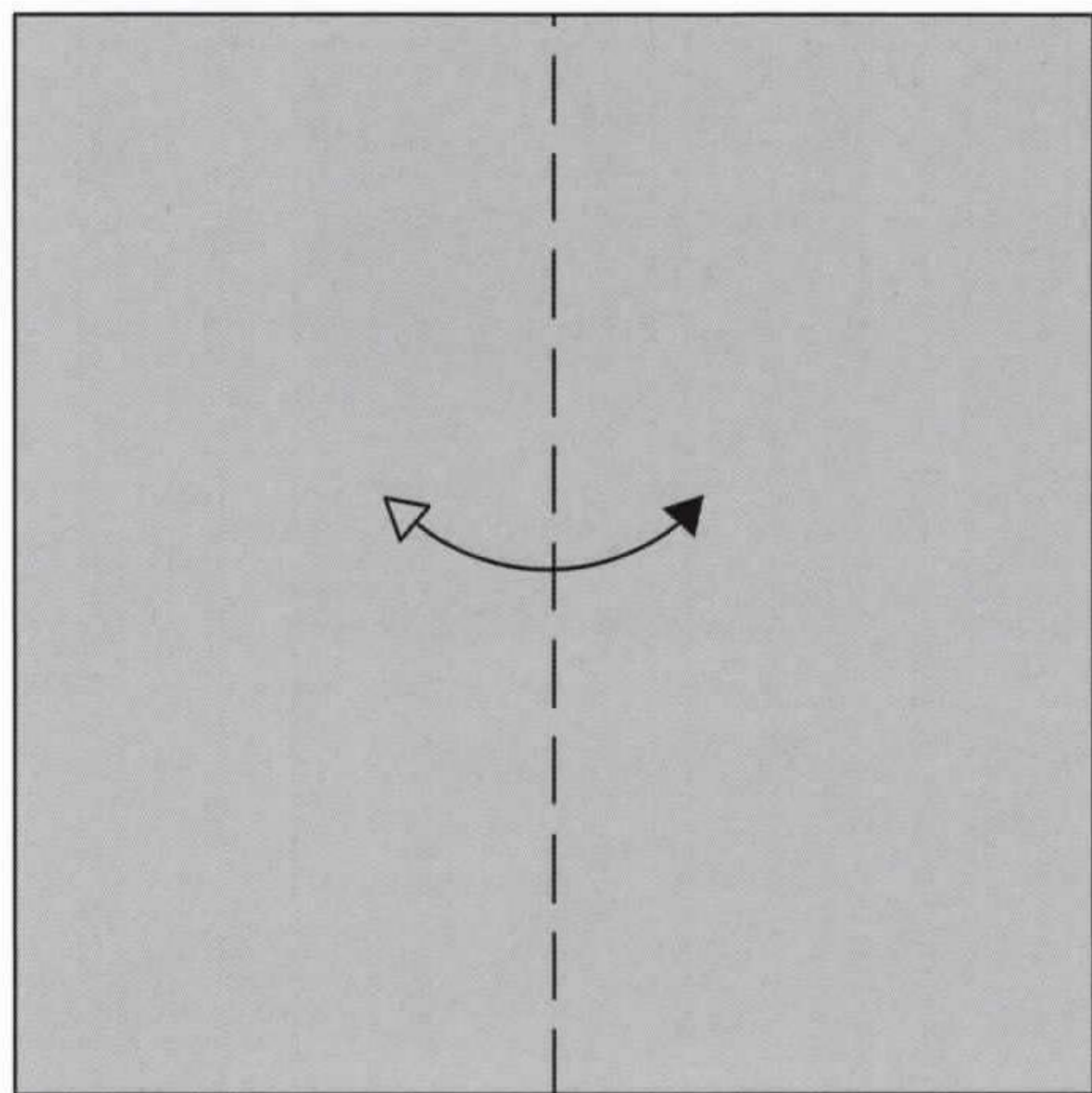

1. Valley fold and unfold

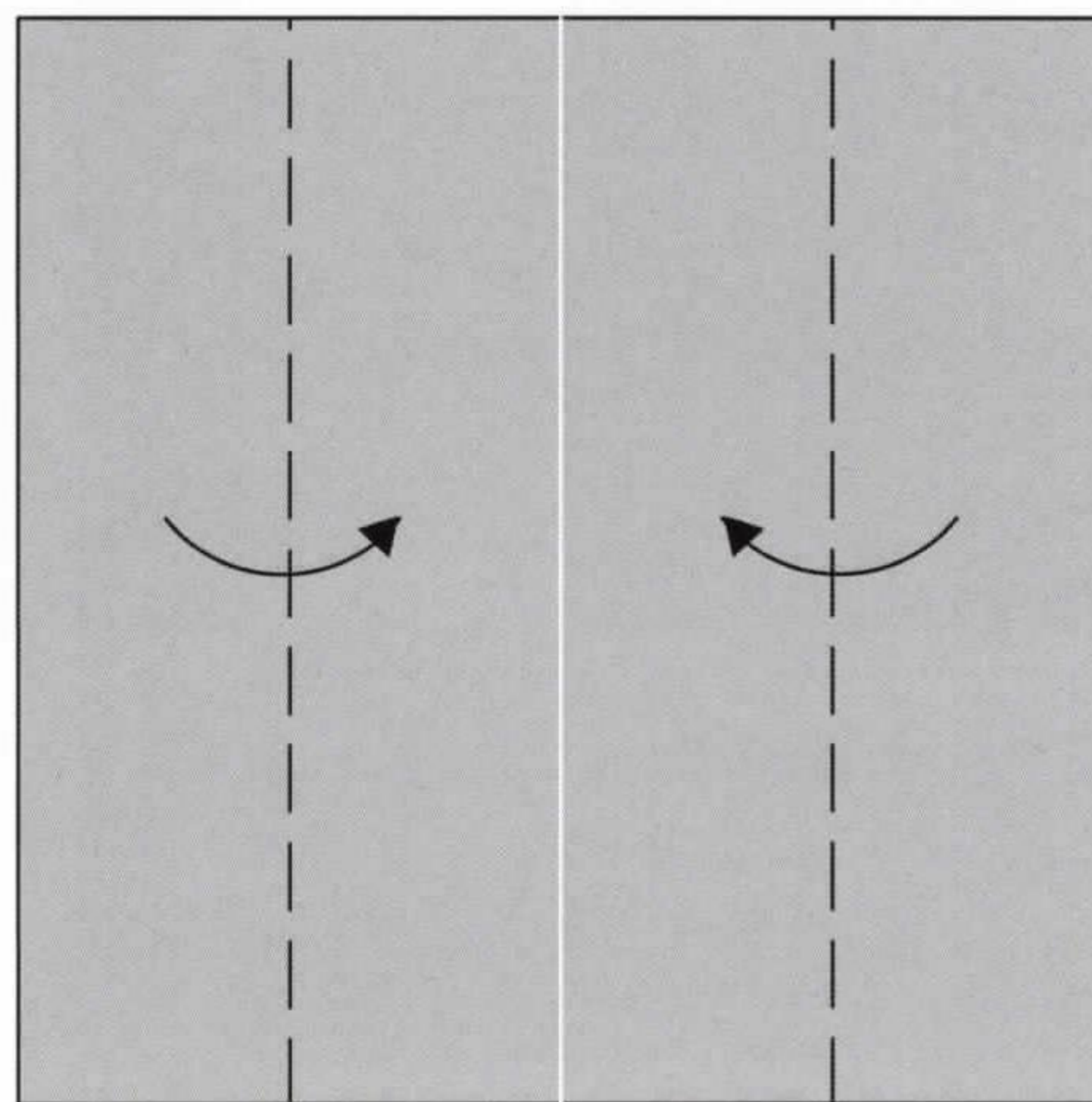

2. Valley folds

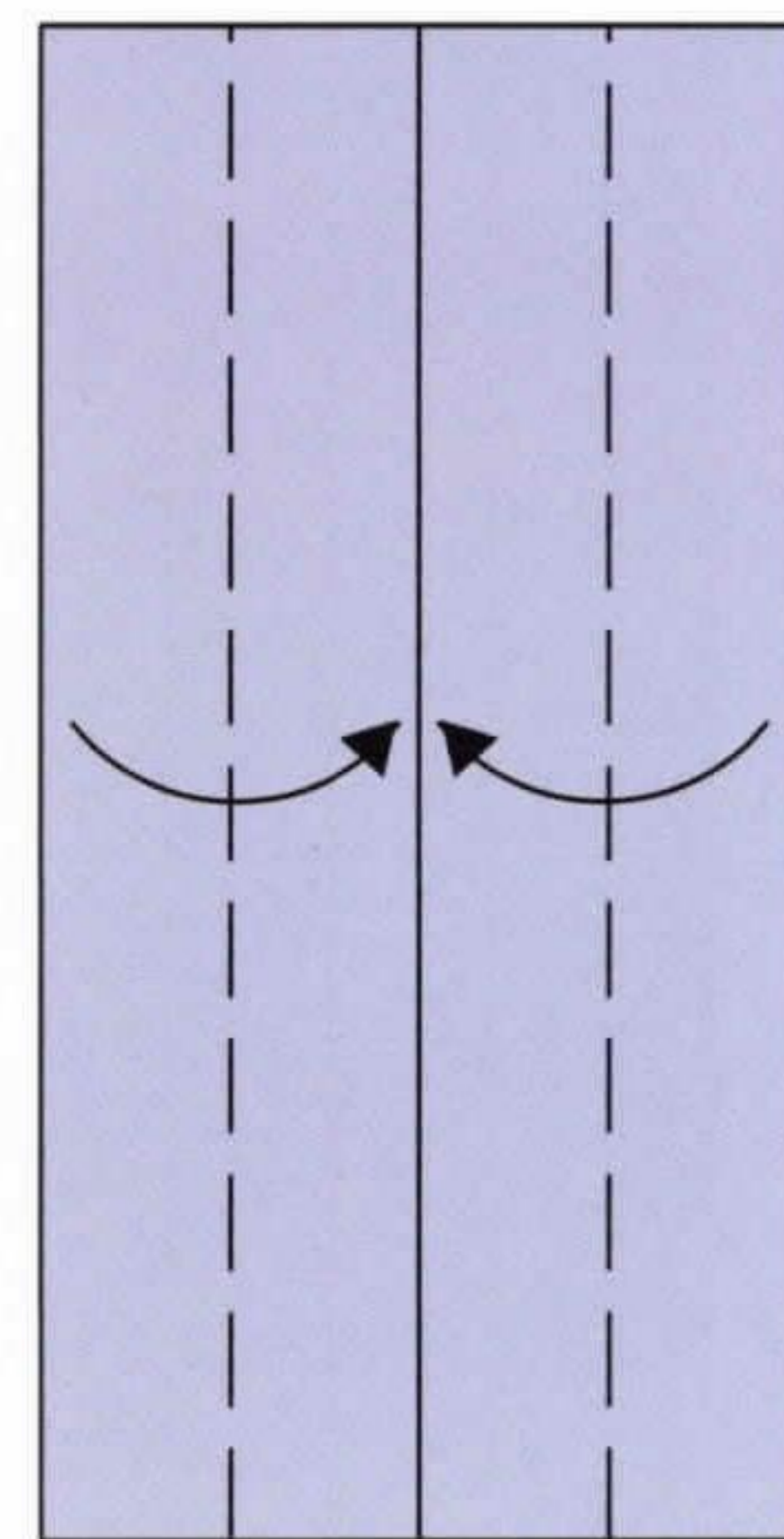

3. Valley folds

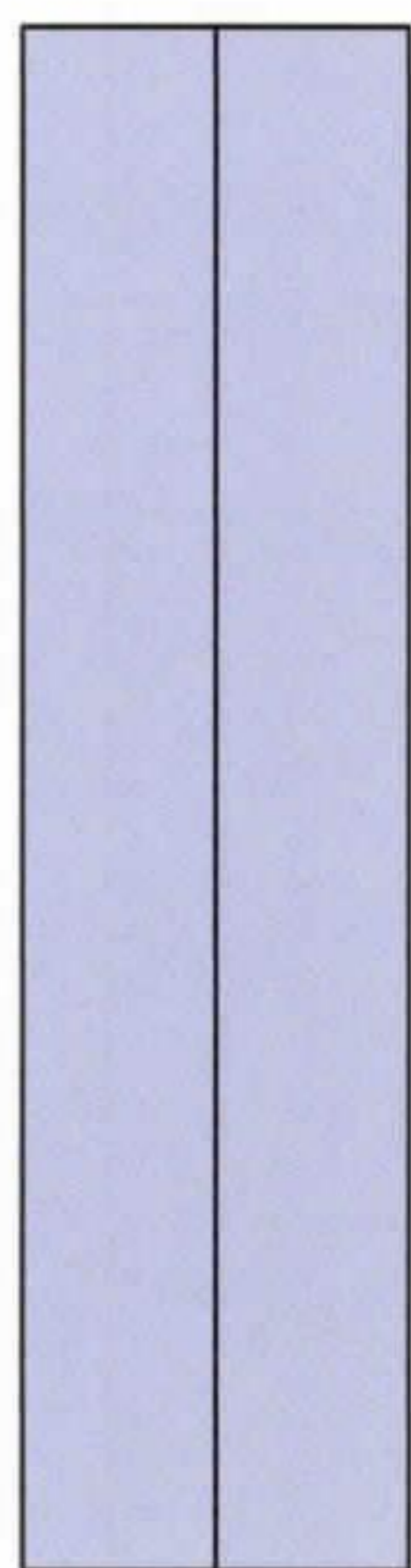

4. Turn over and scale-up

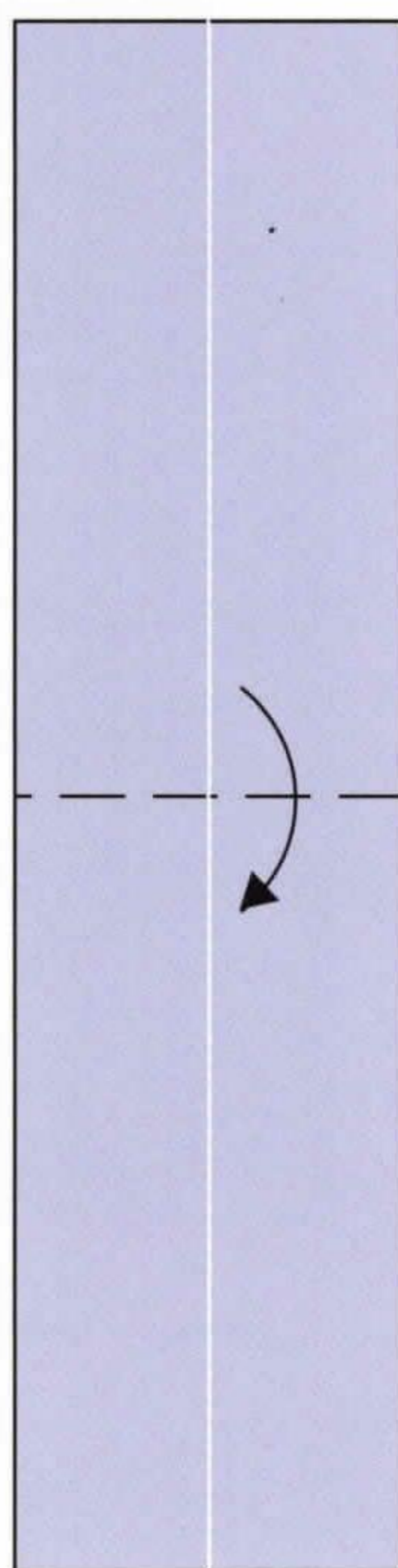
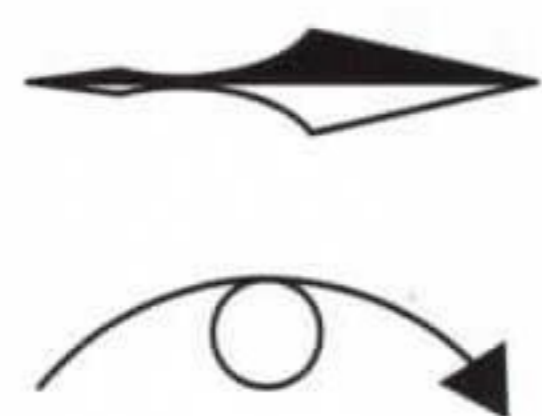

5. Valley fold

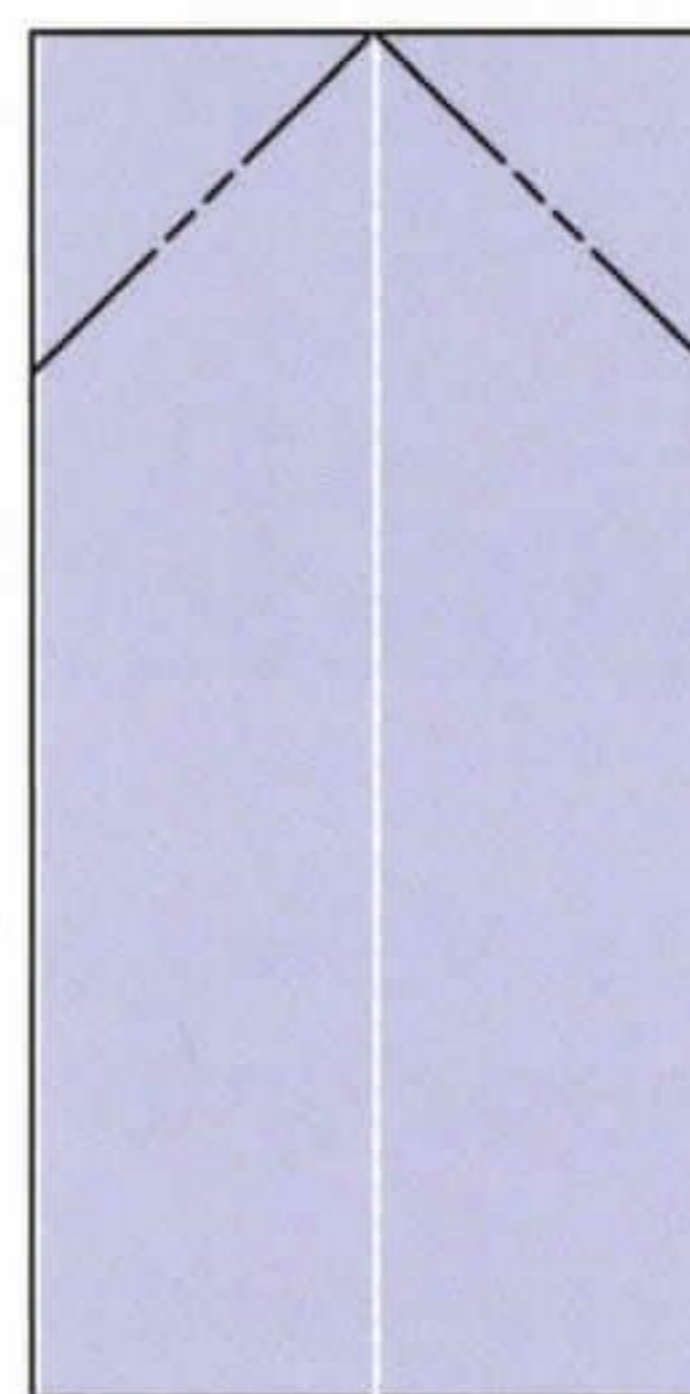

6. Inside reverse folds

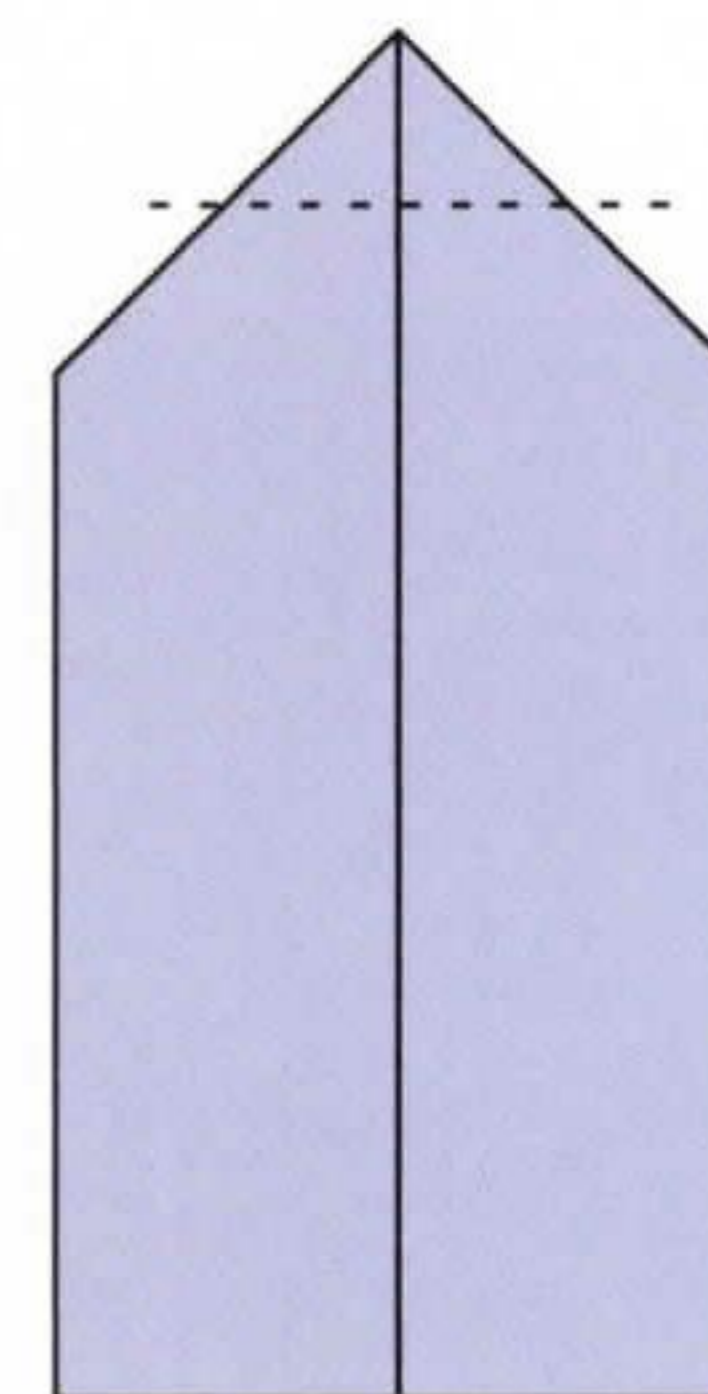

7. Sink fold

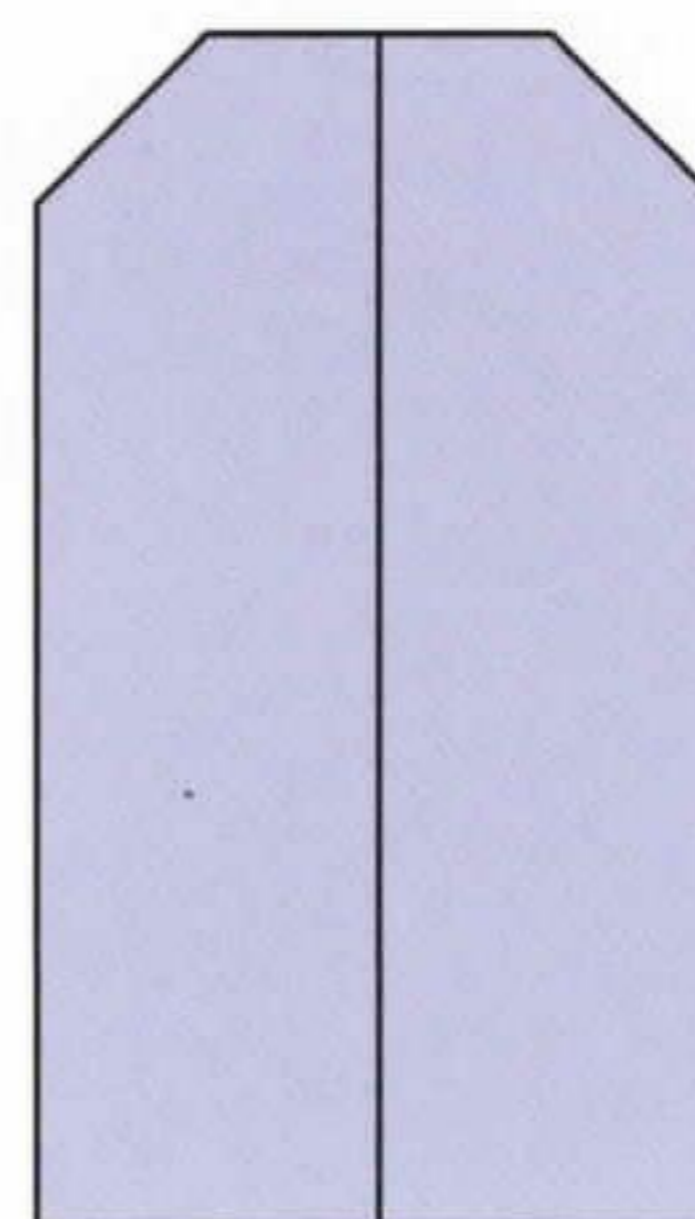

8. Rotate

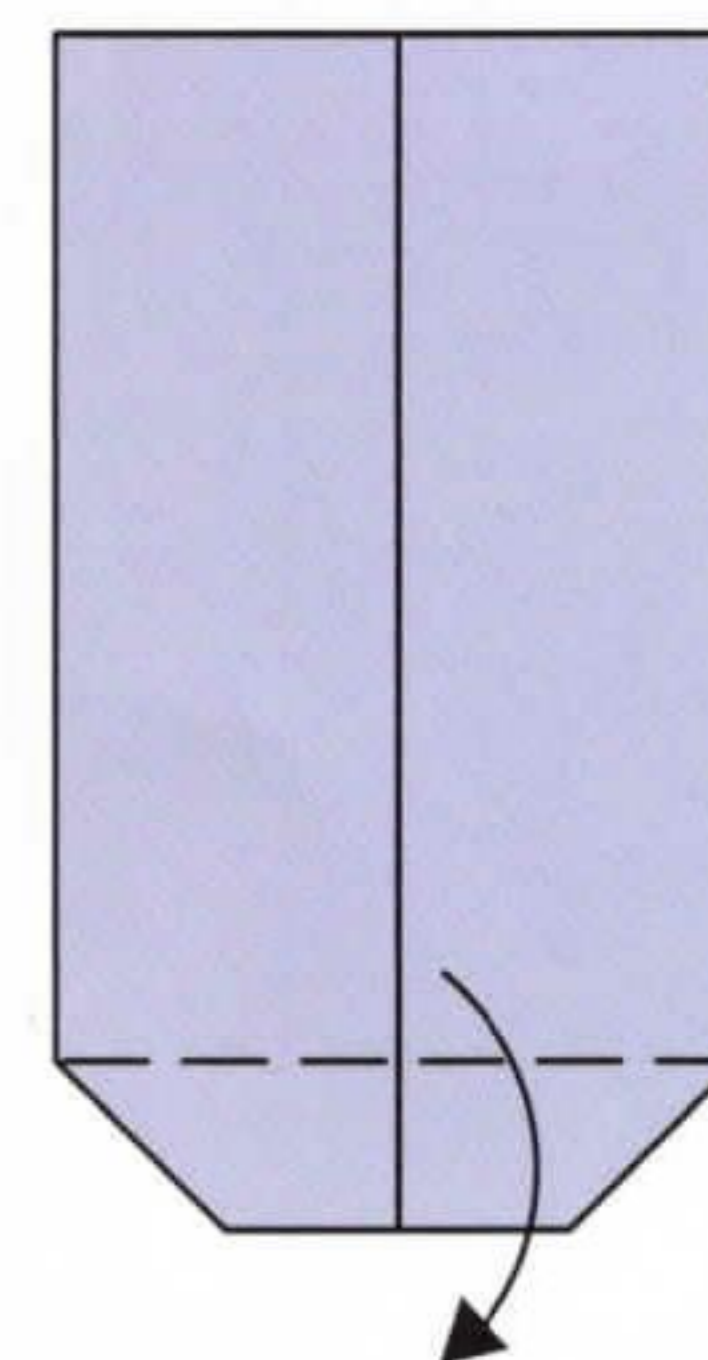

9. Valley fold

INSIDE CRIMP FOLD

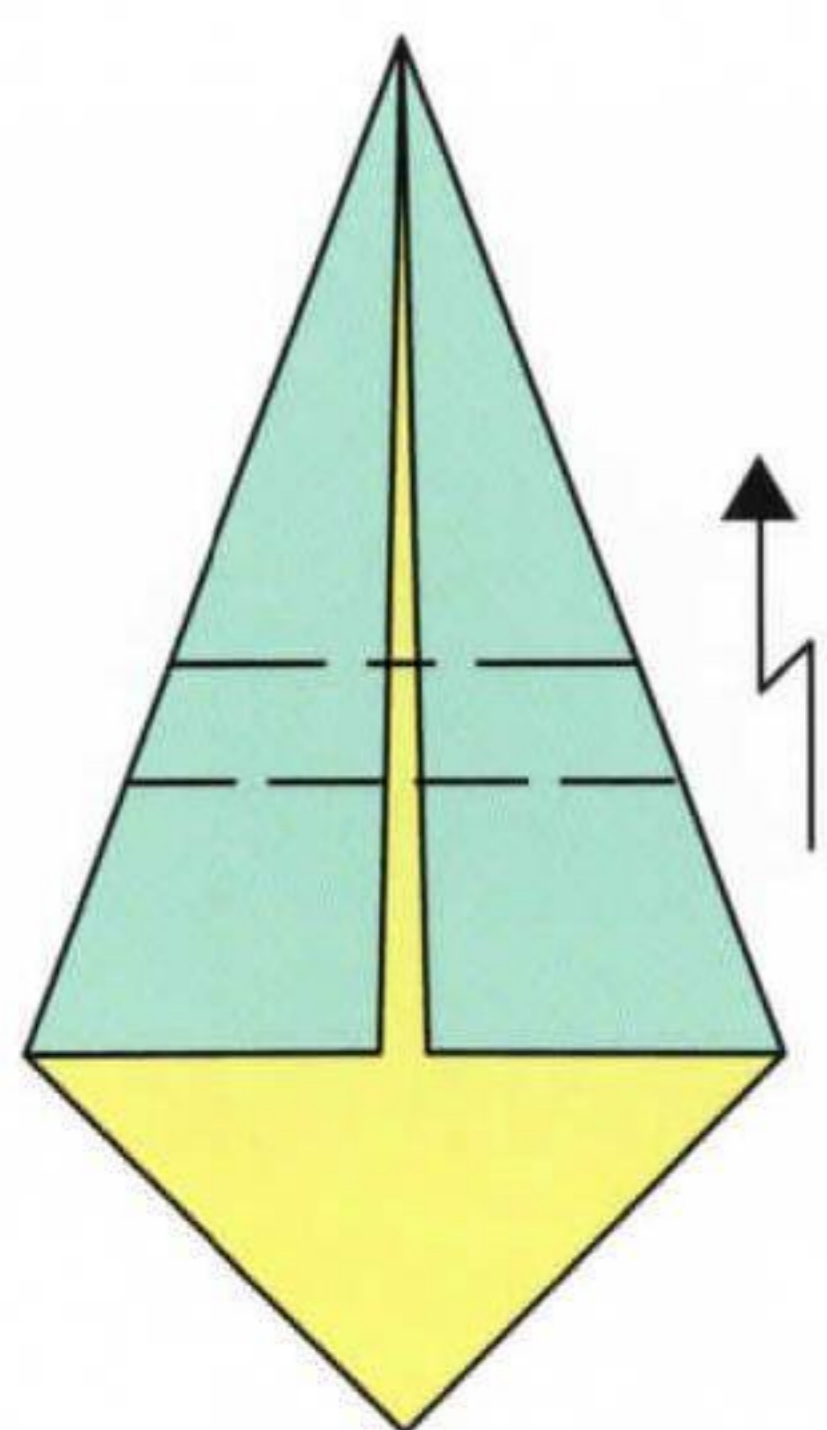

1. Kite fold, then Pleat fold

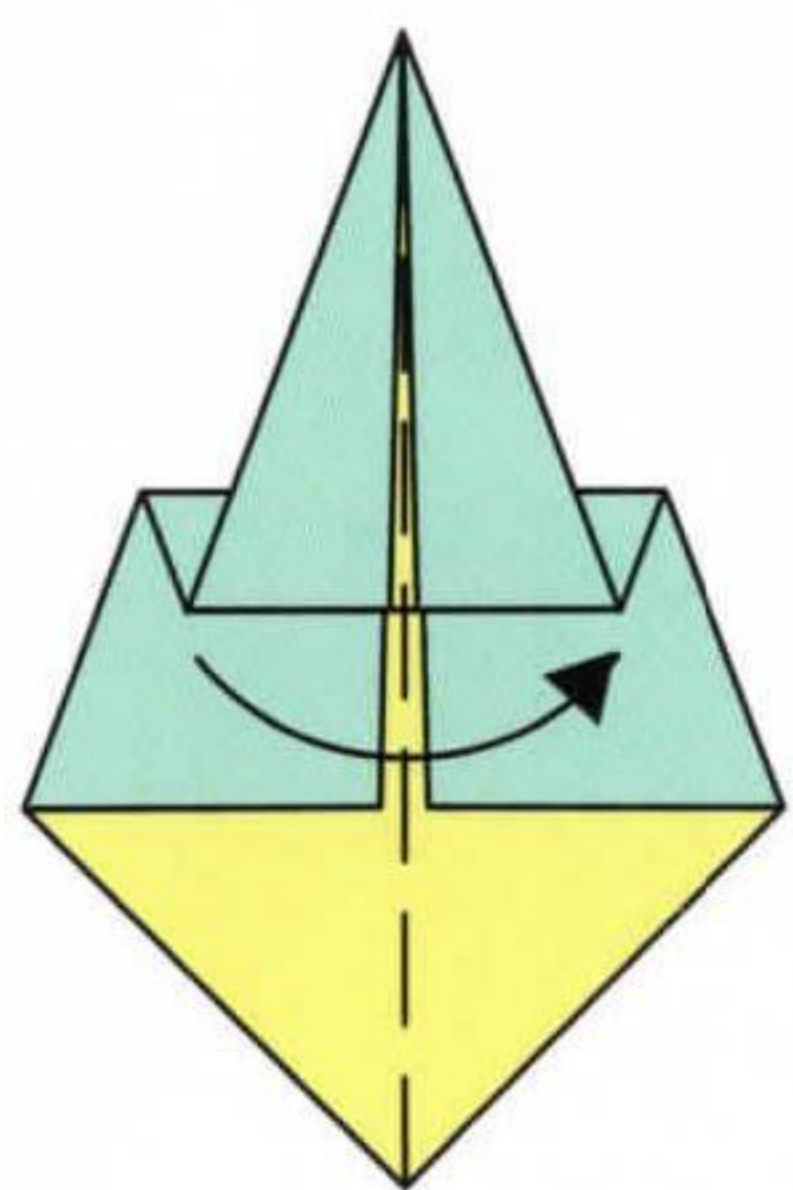

2. Valley fold

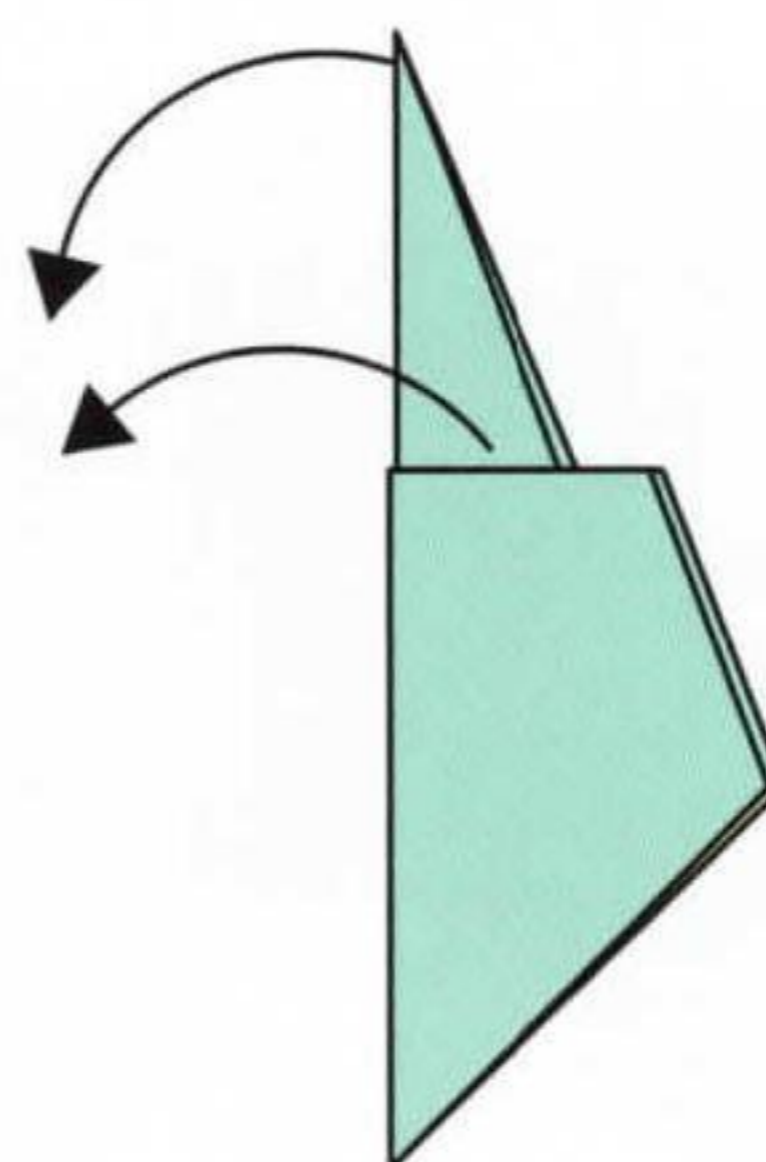

3. Pull and fold

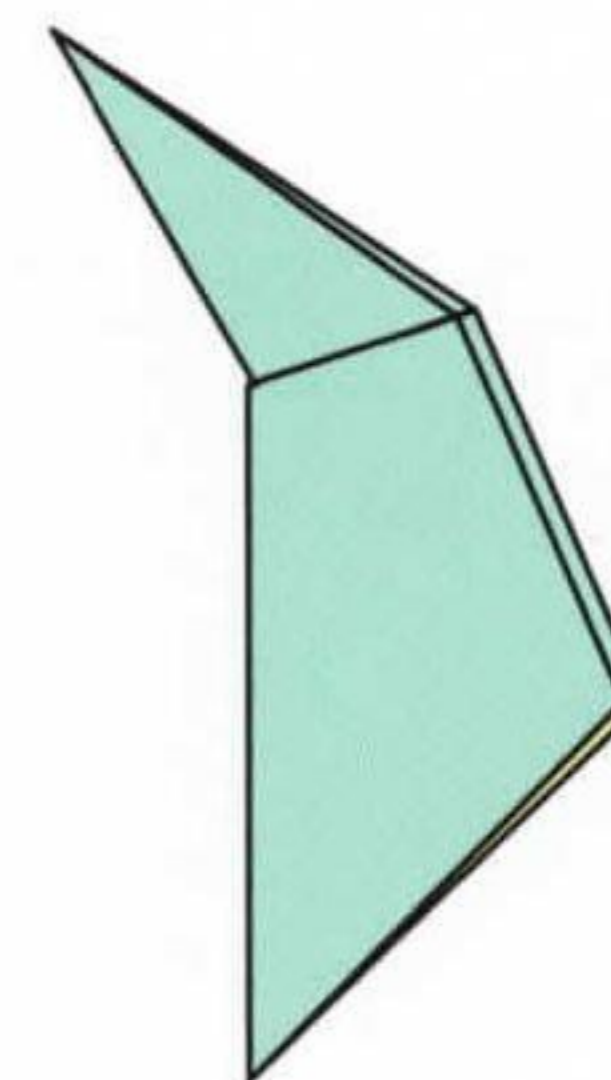

4. Completed INSIDE CRIMP FOLD

OUTSIDE CRIMP FOLD

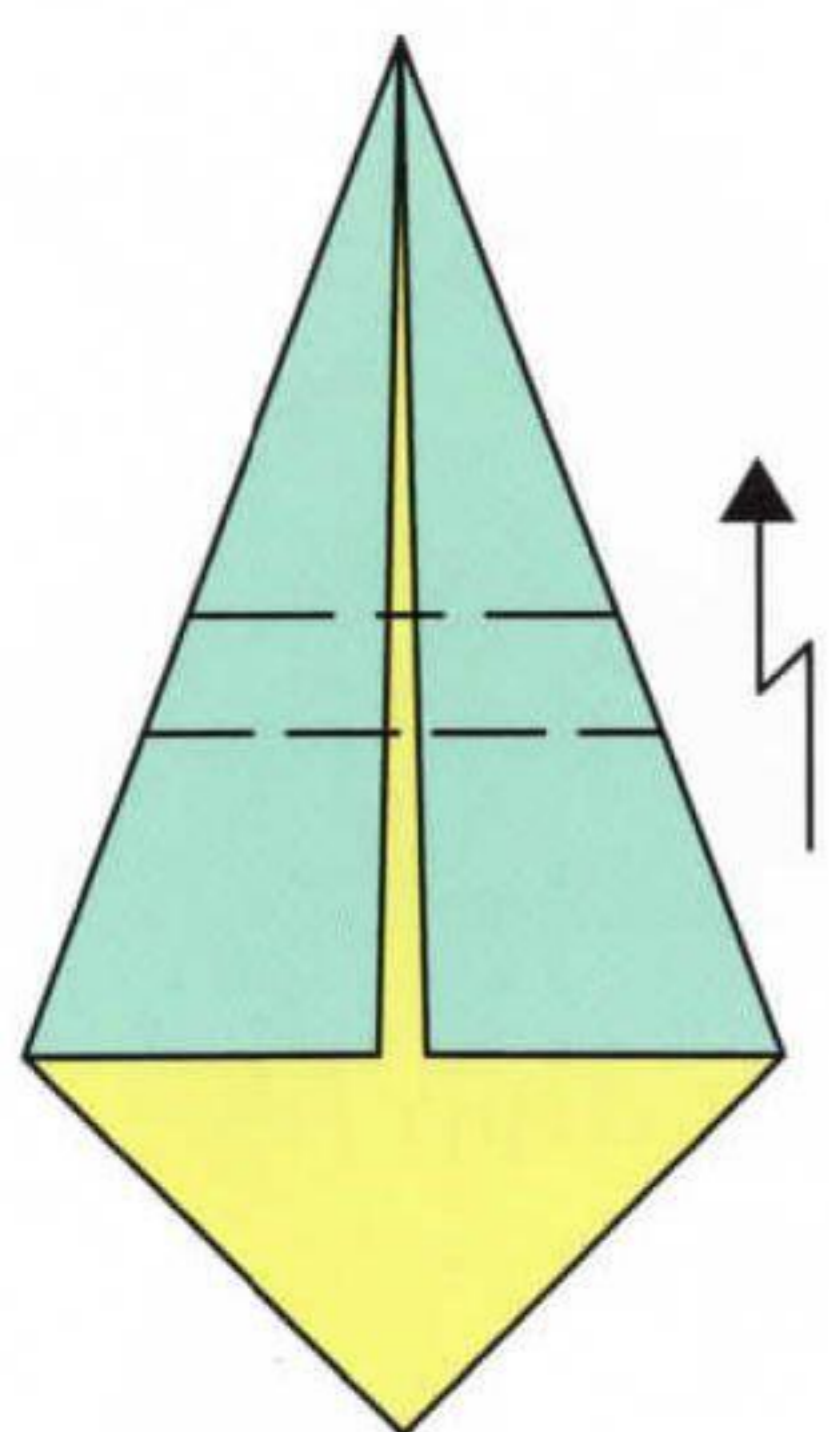

1. Kite fold, then Pleat fold and unfold

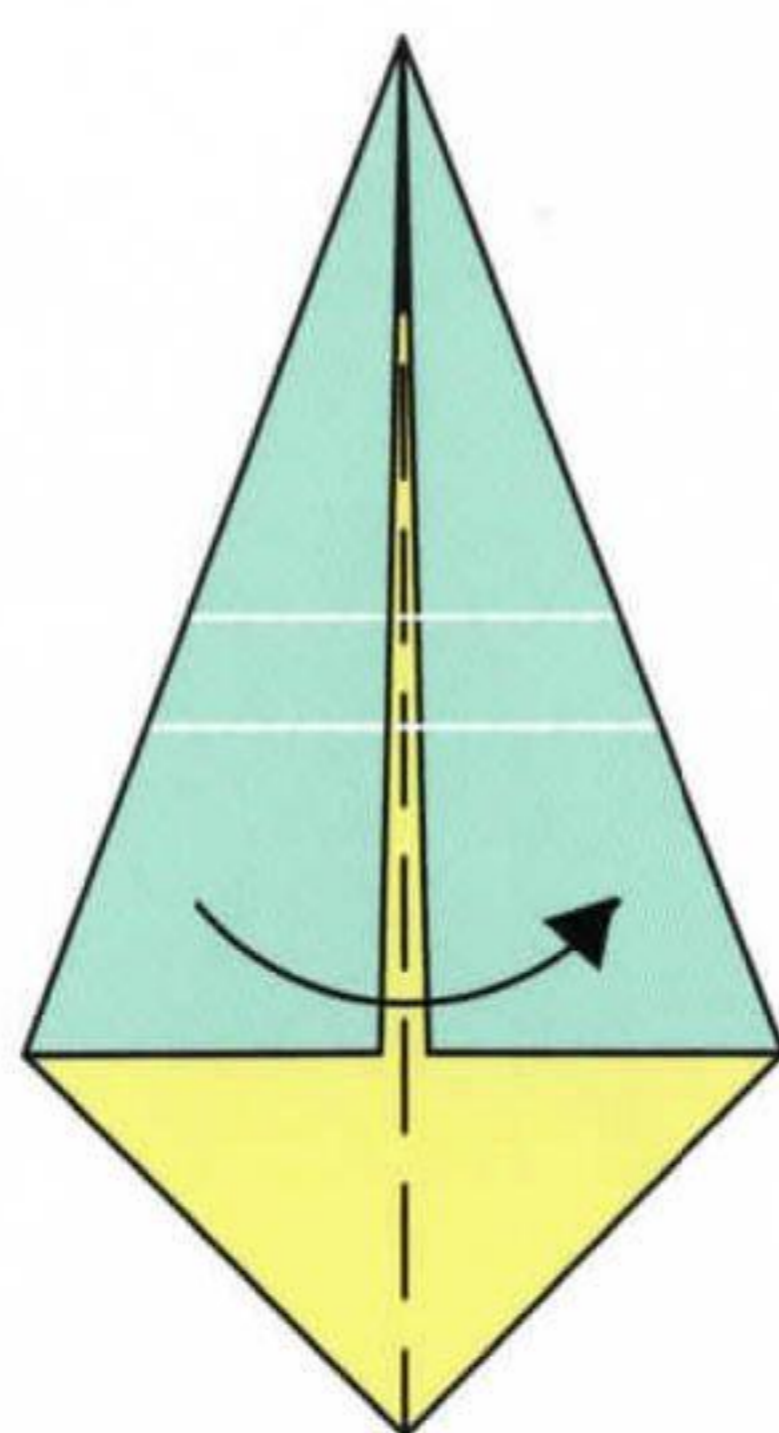

2. Valley fold

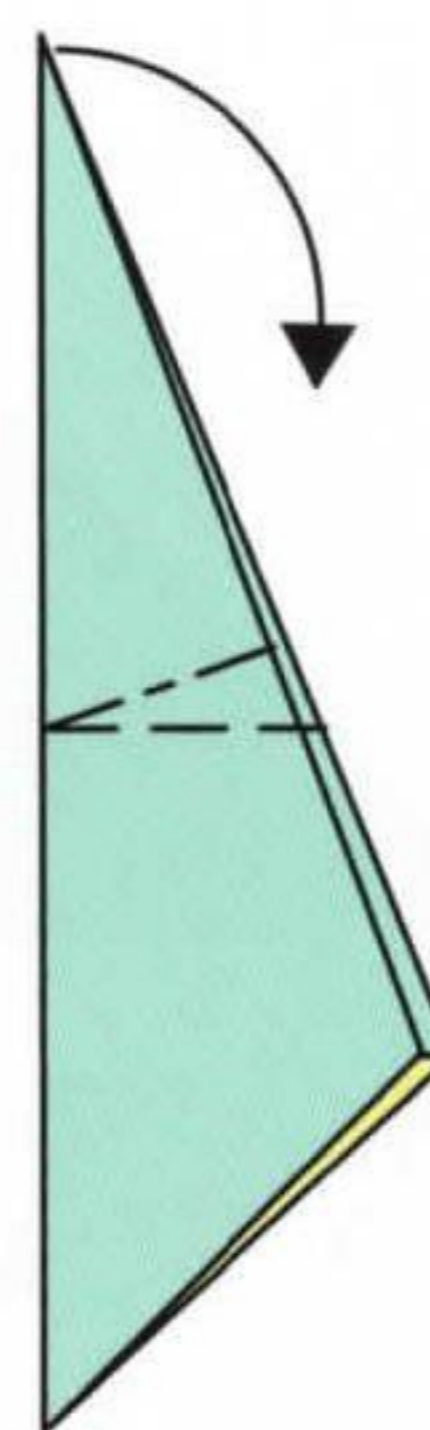

3. Pull and fold

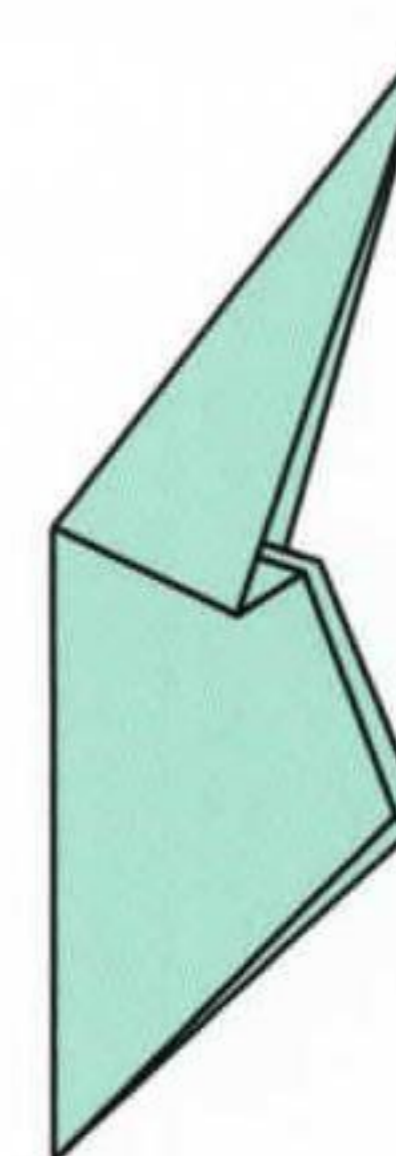

4. Completed OUTSIDE CRIMP FOLD

wardrobe: part 2

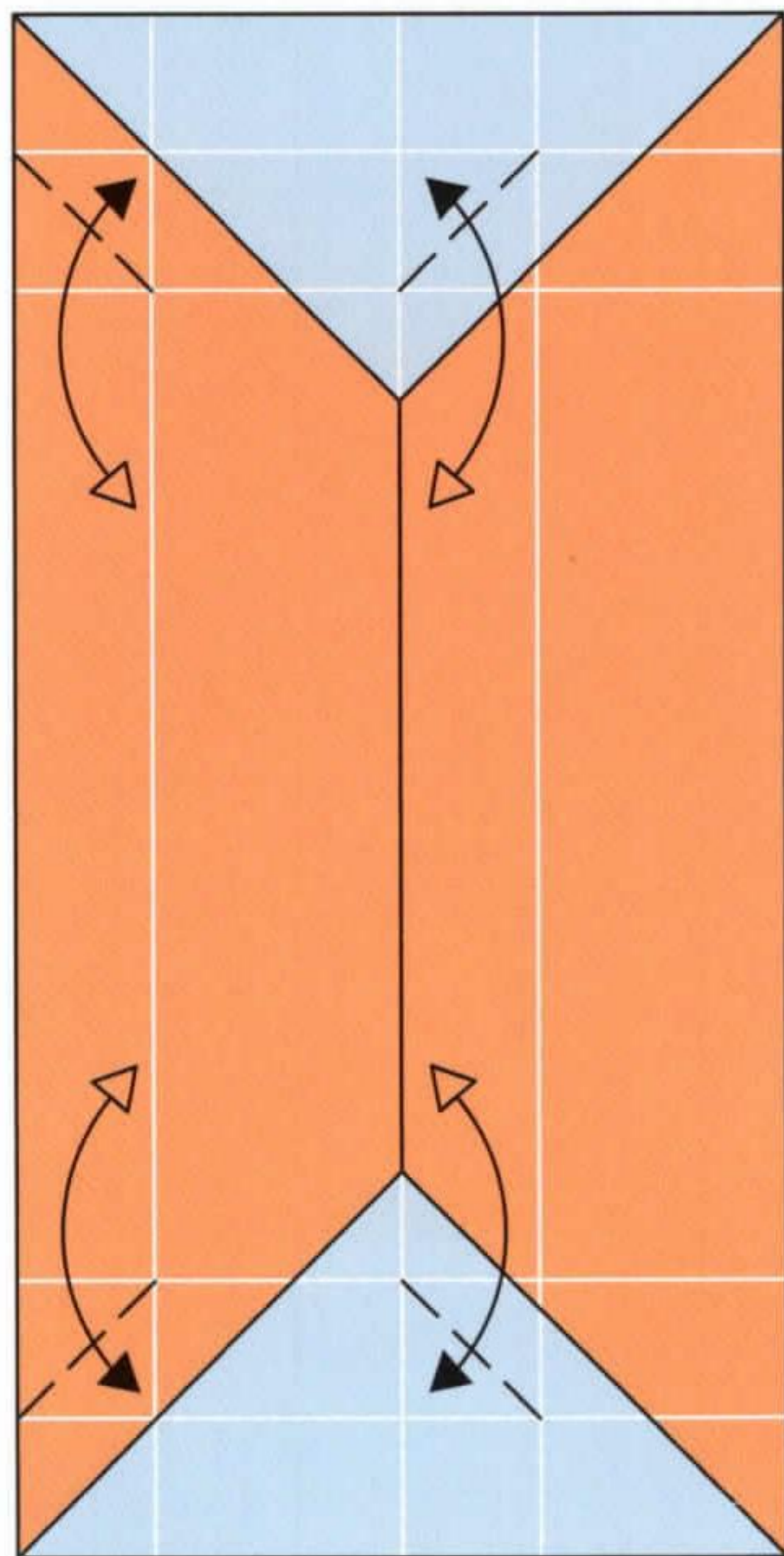

9. Valley folds and unfold

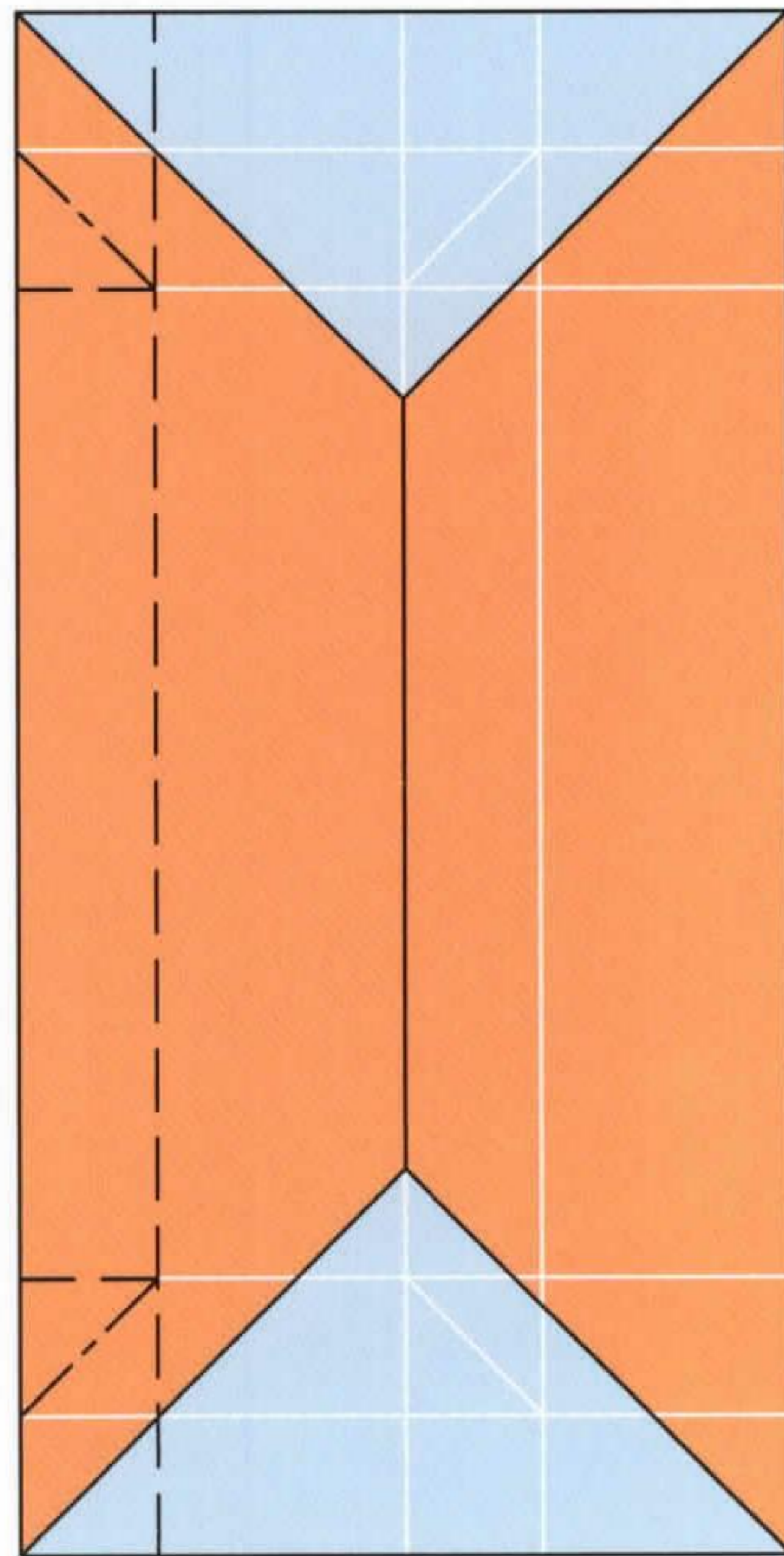

10. Crimp folds

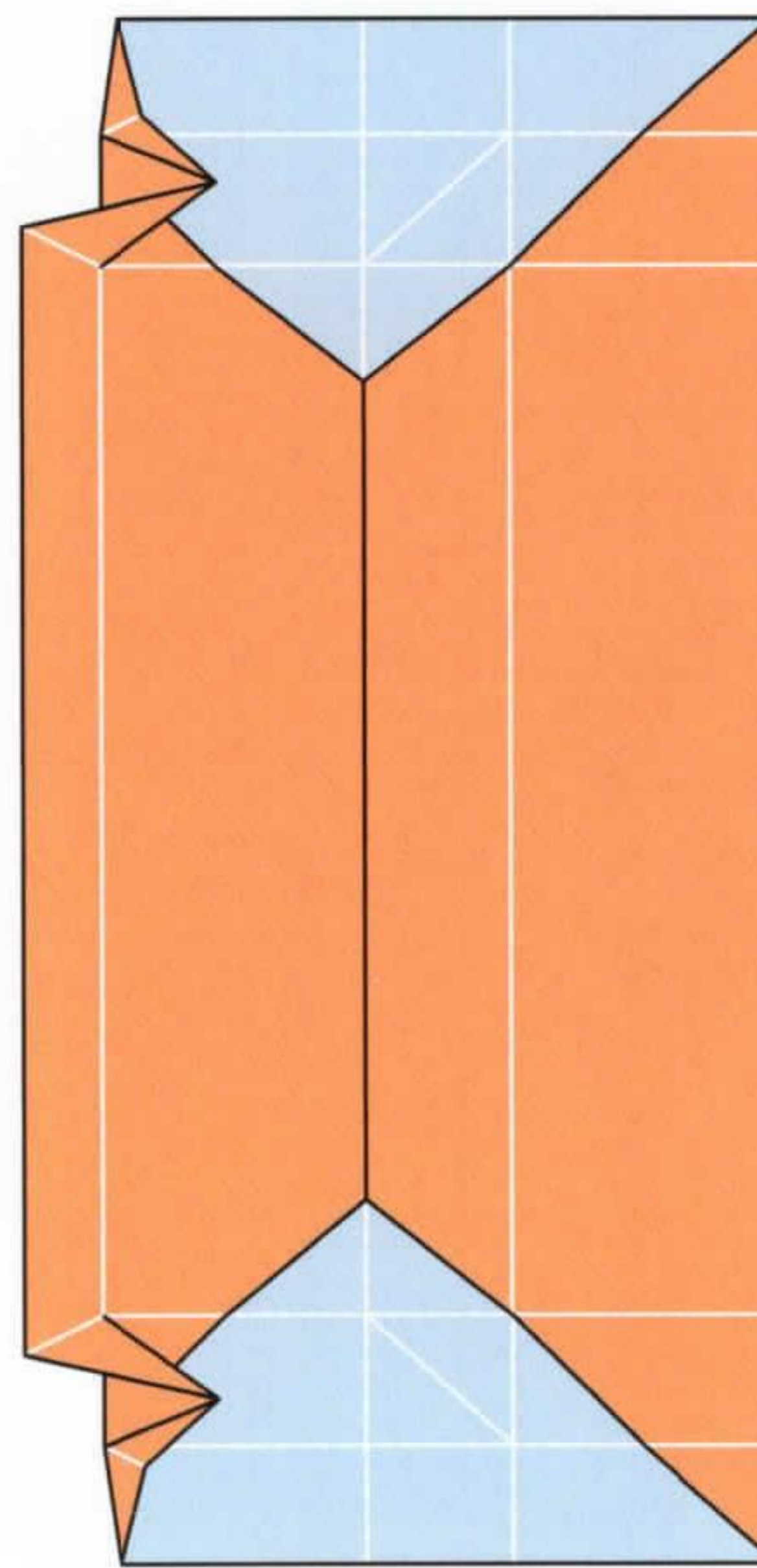

11. Before complete

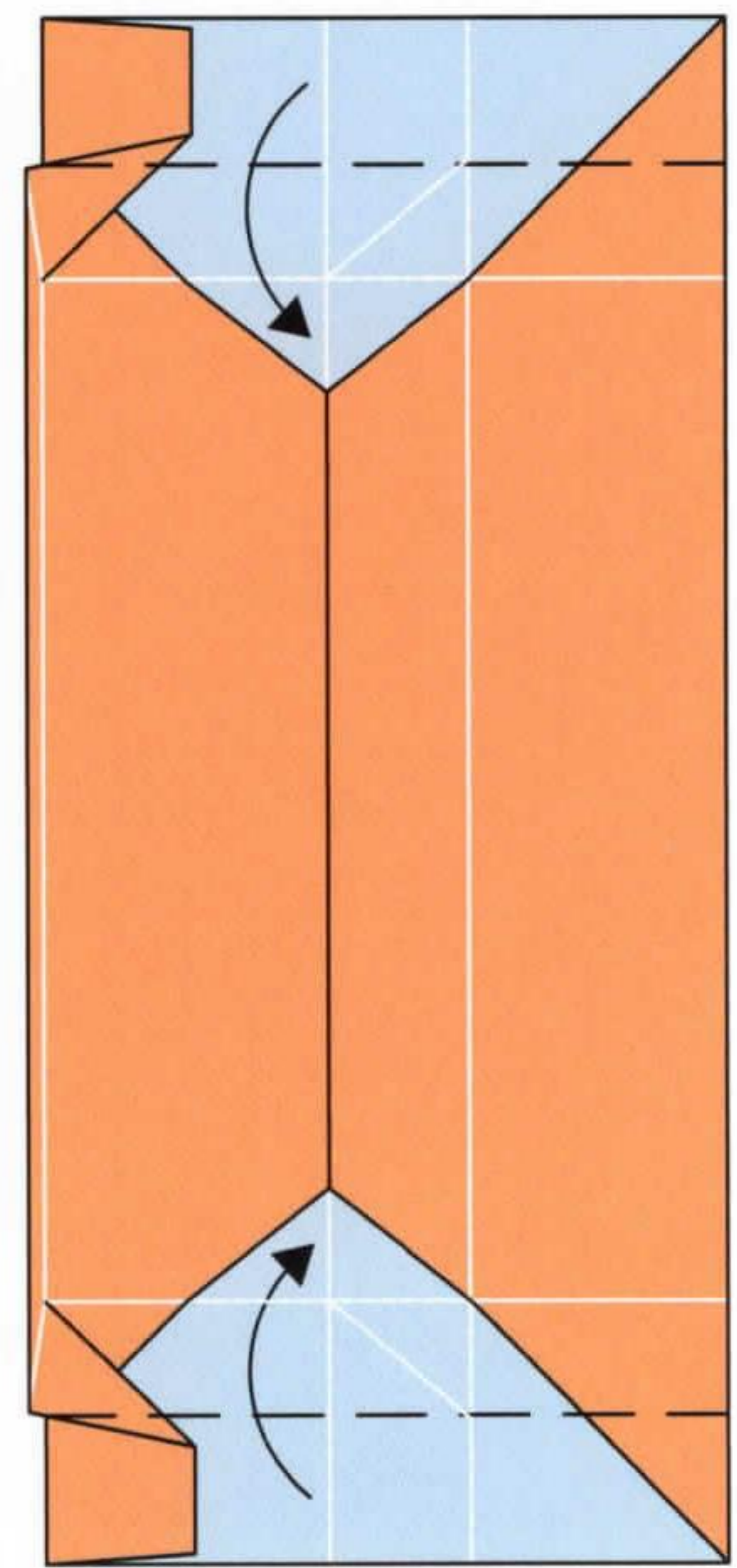

12. Valley folds

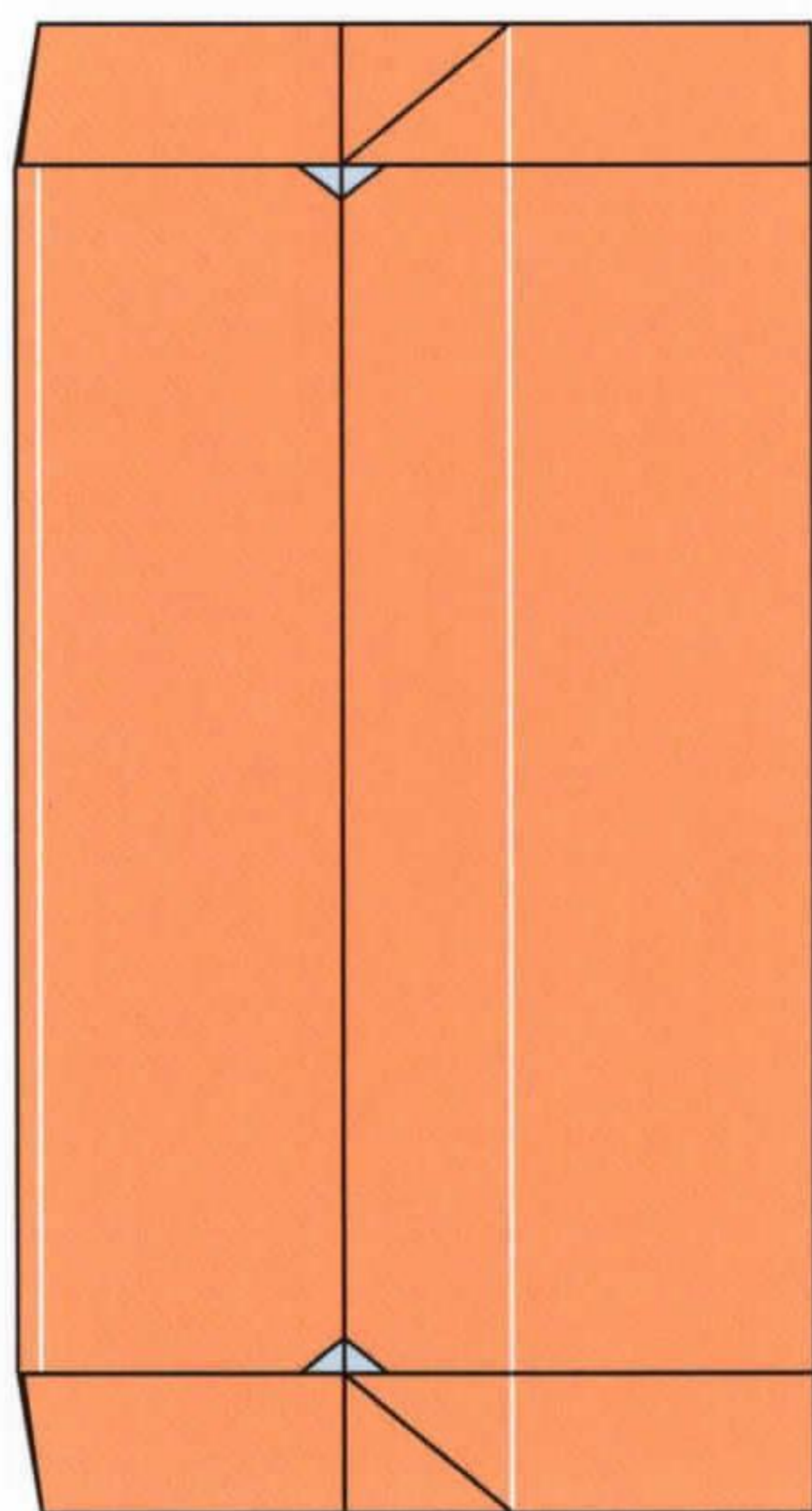

13. Crimp folds

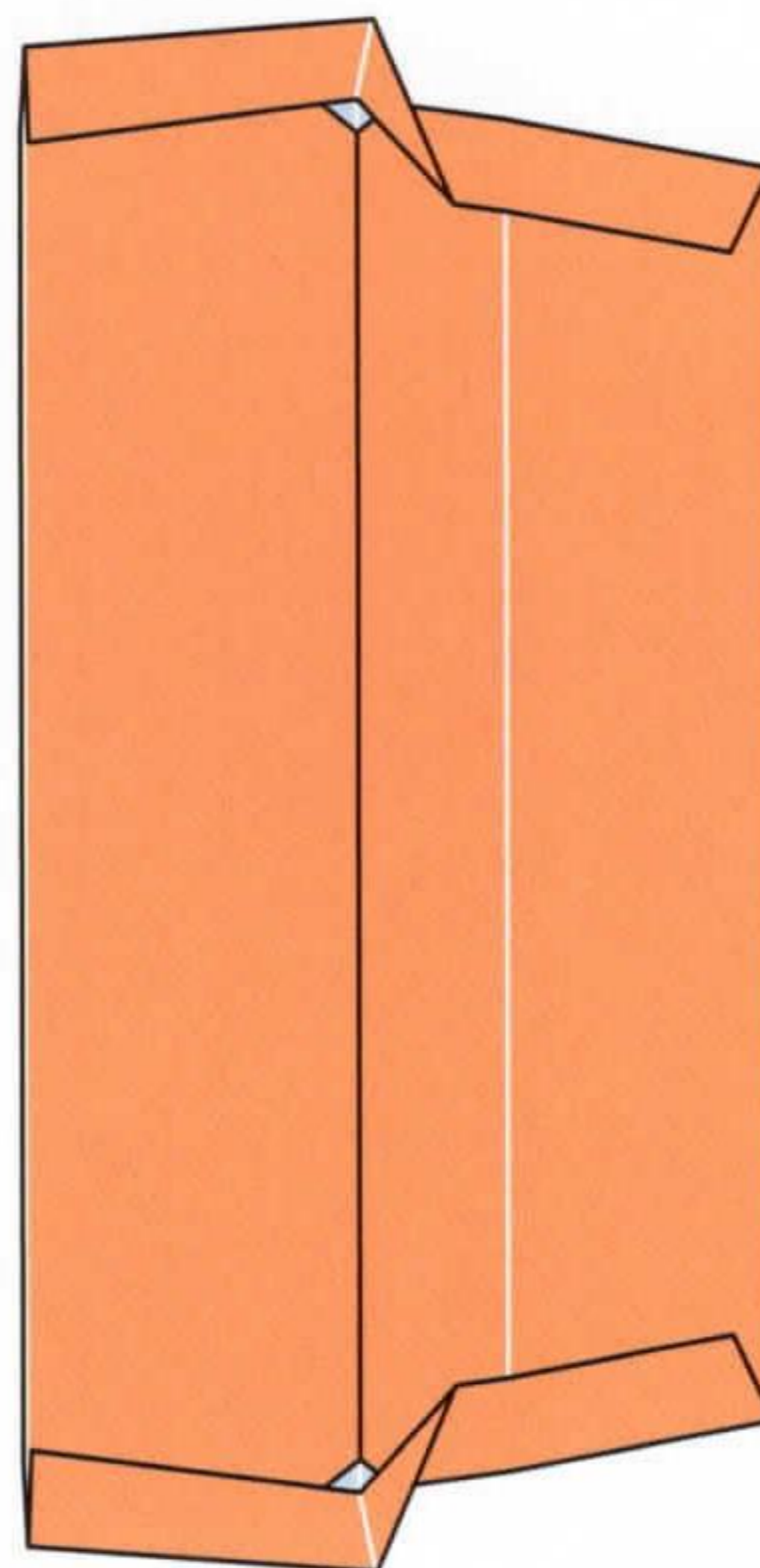

14. Before complete

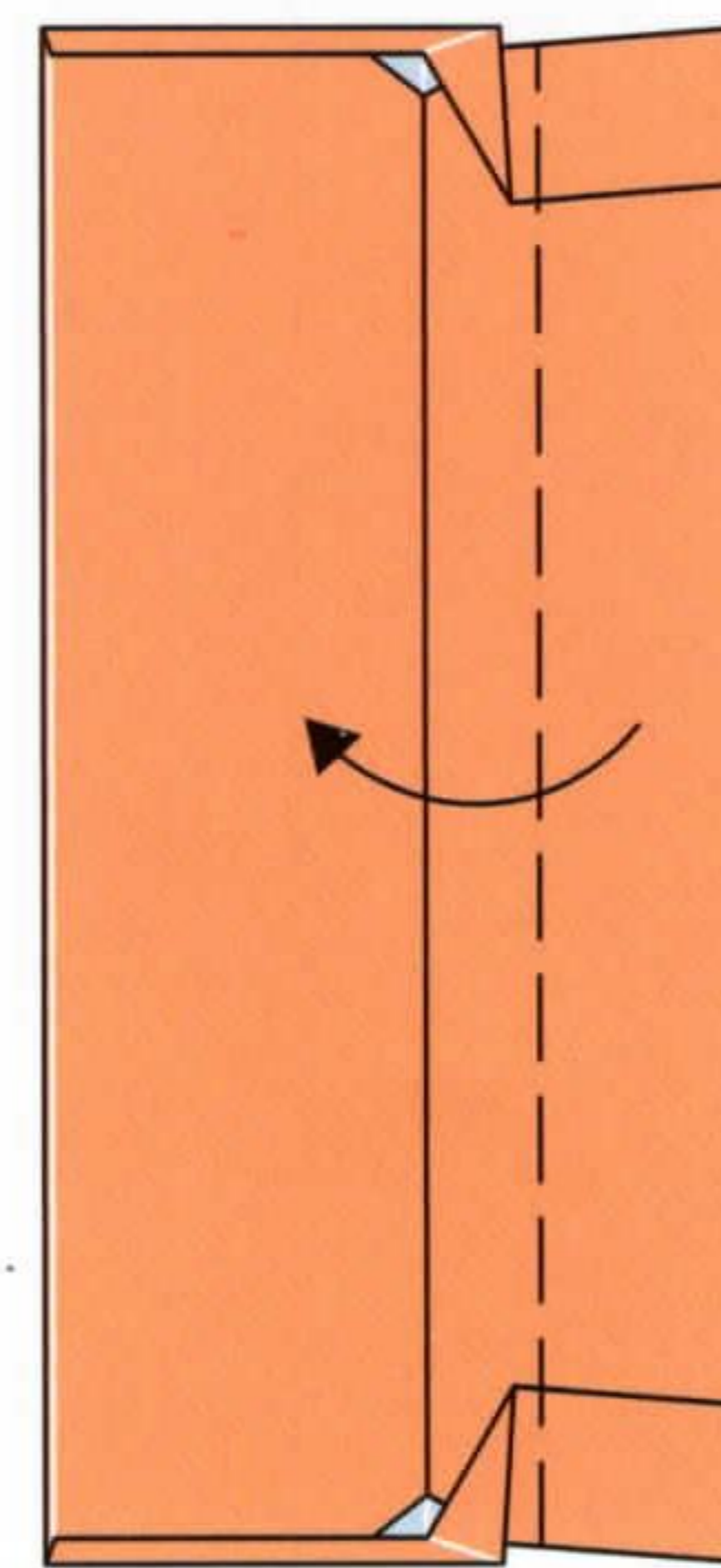

15. Close door

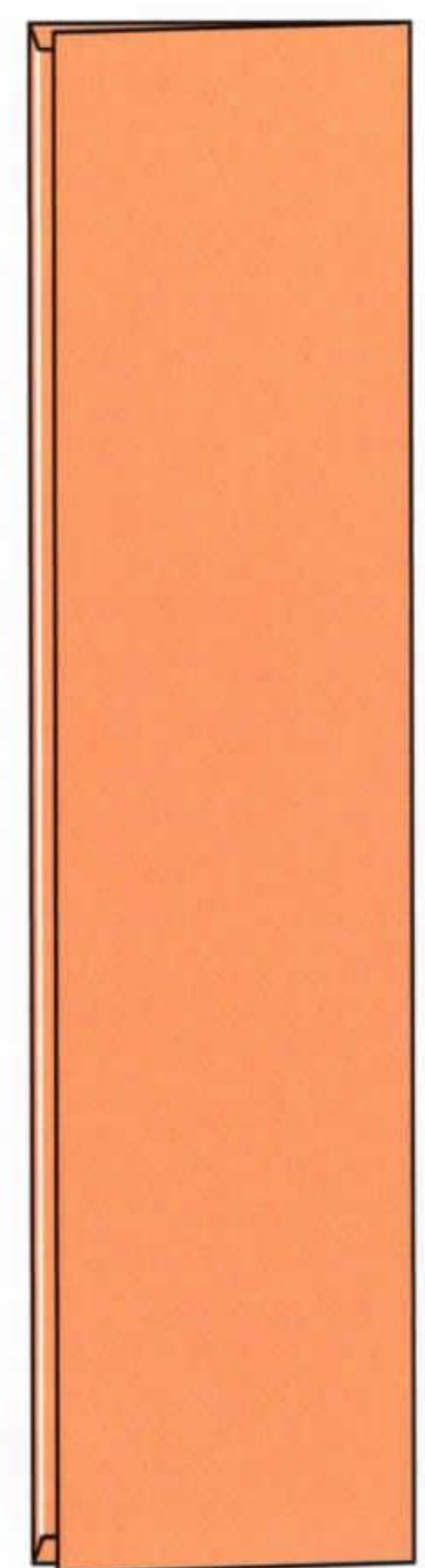

16. Completed
PART 2

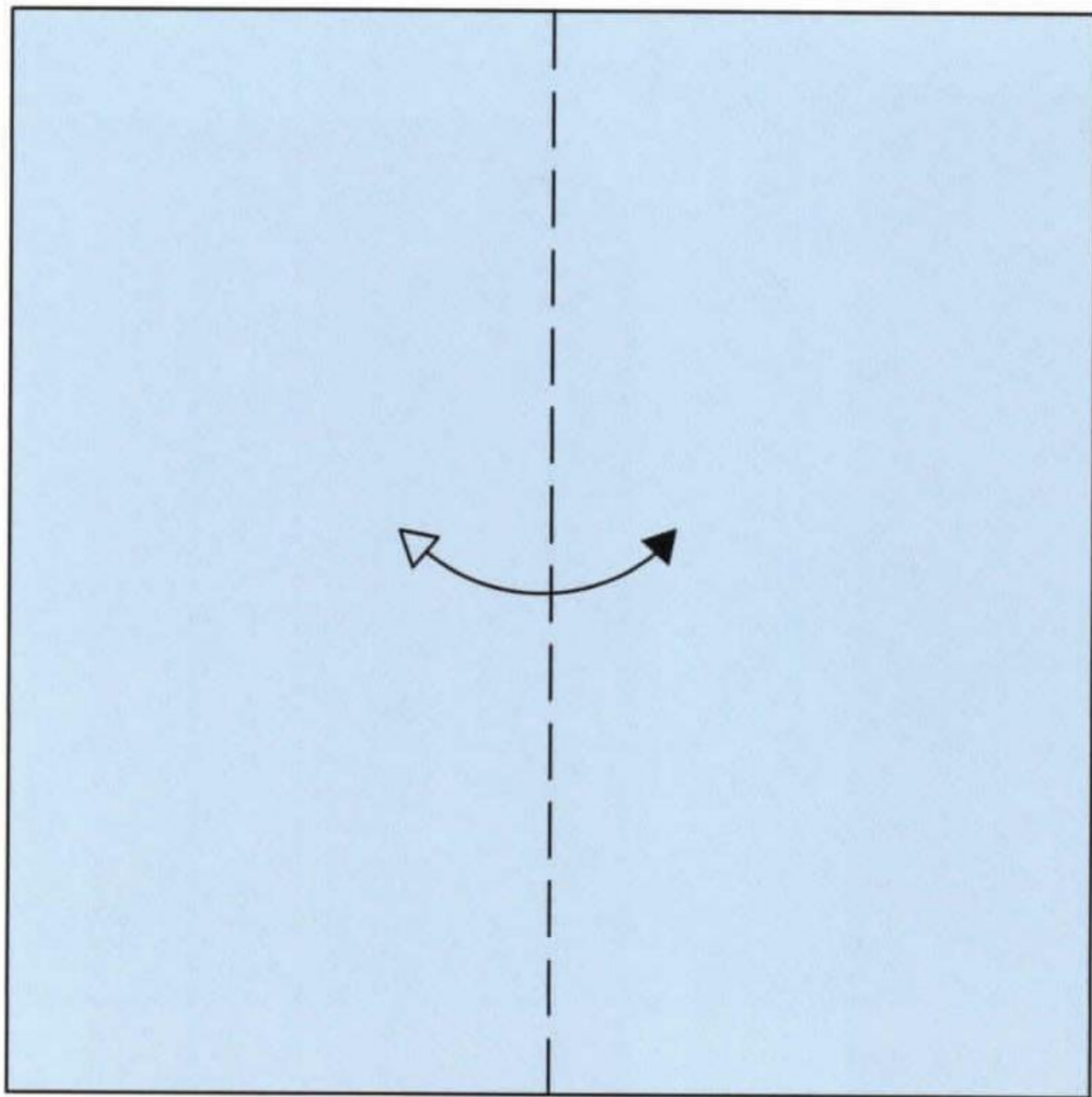

1. Valley fold and unfold

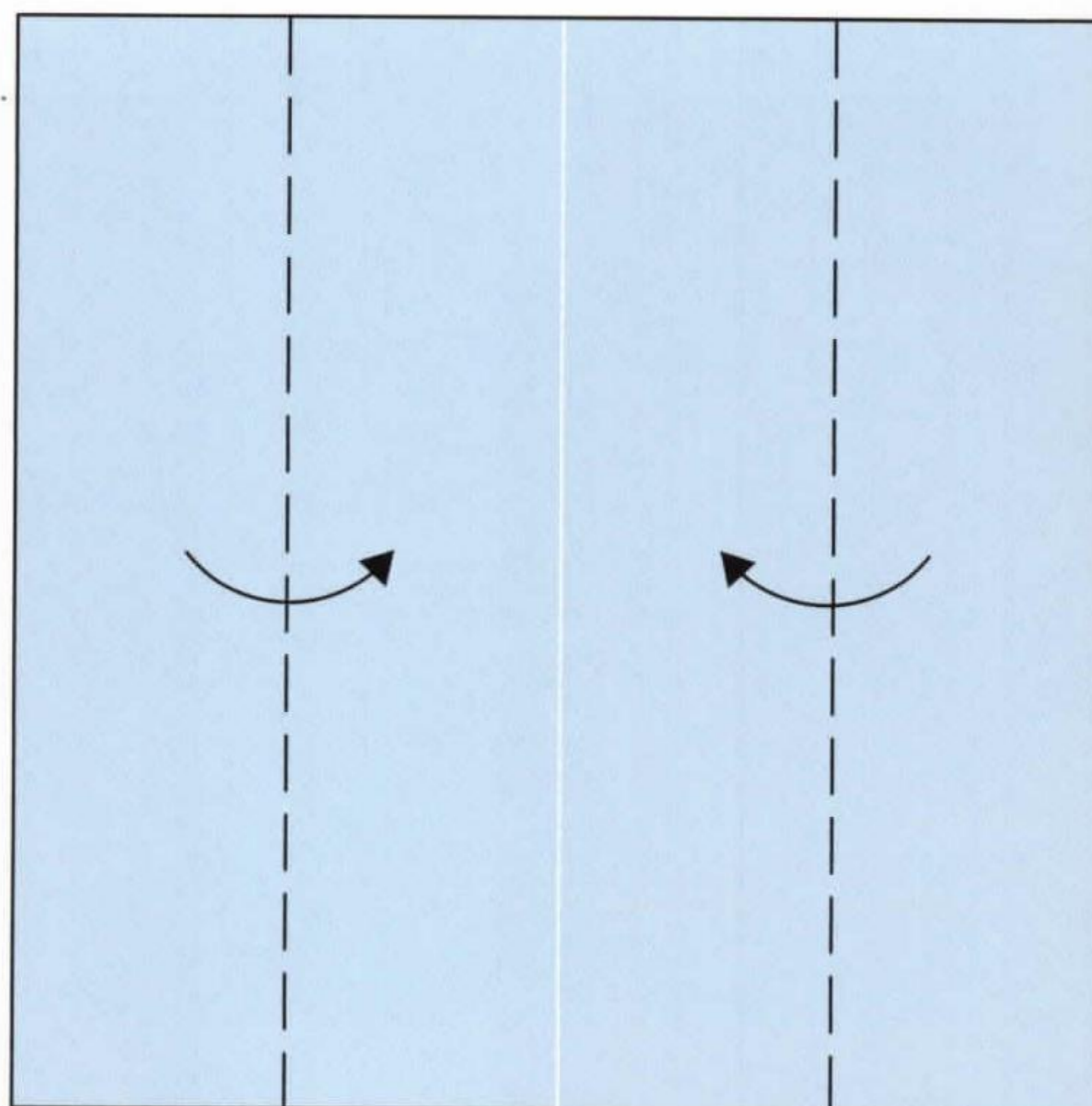

2. Valley folds

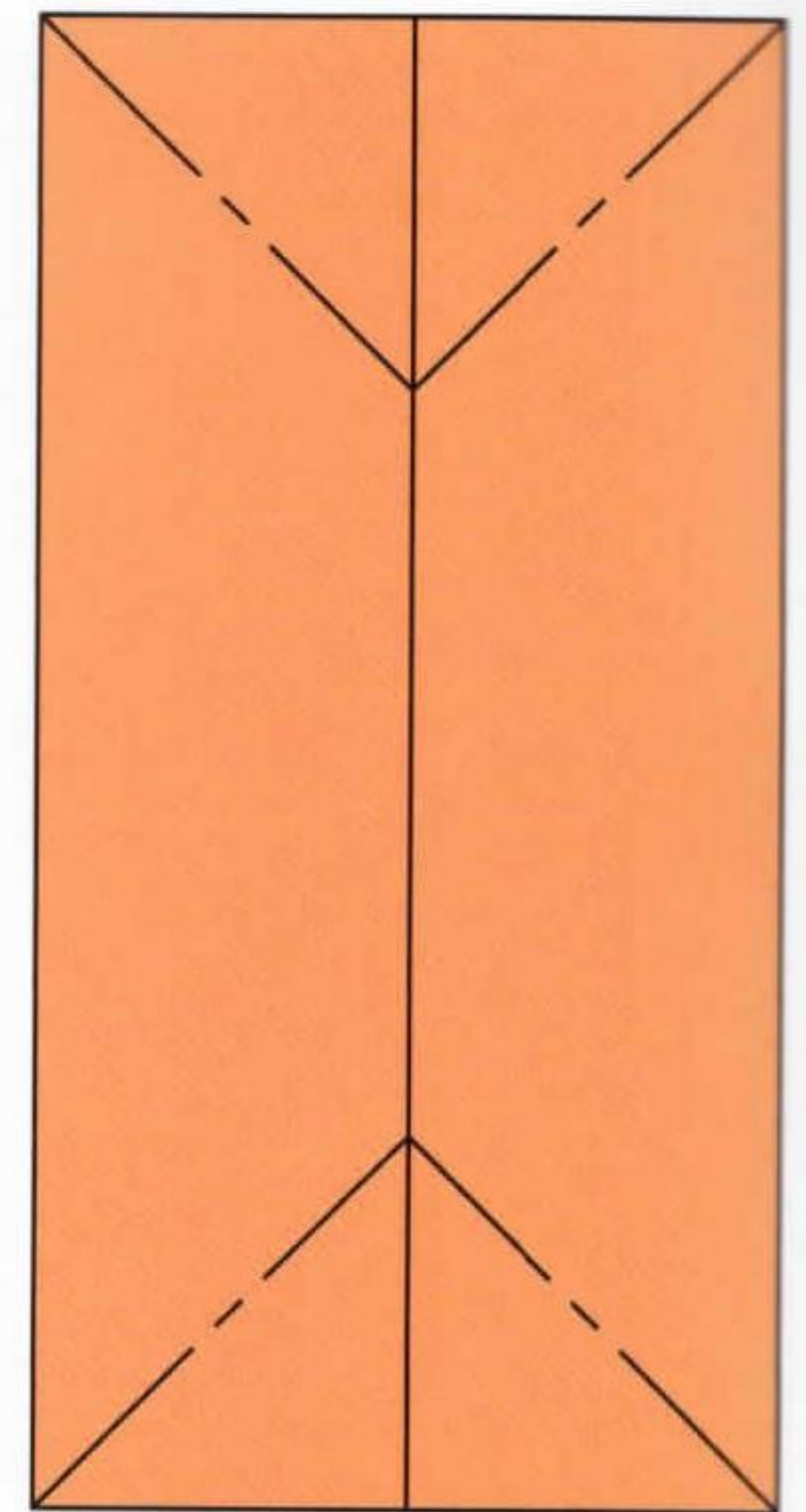

3. Mountain folds

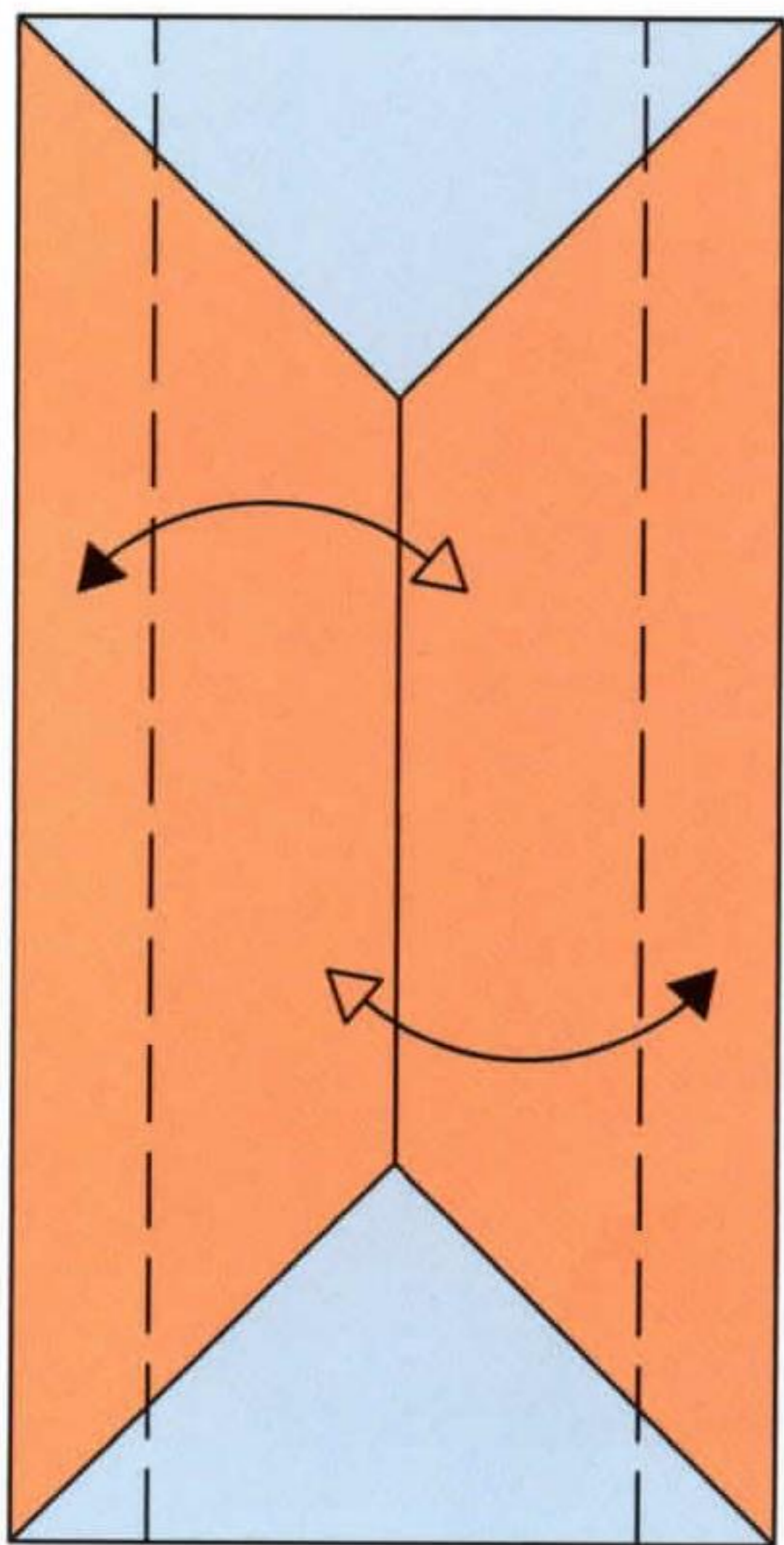

4. Valley folds and unfold

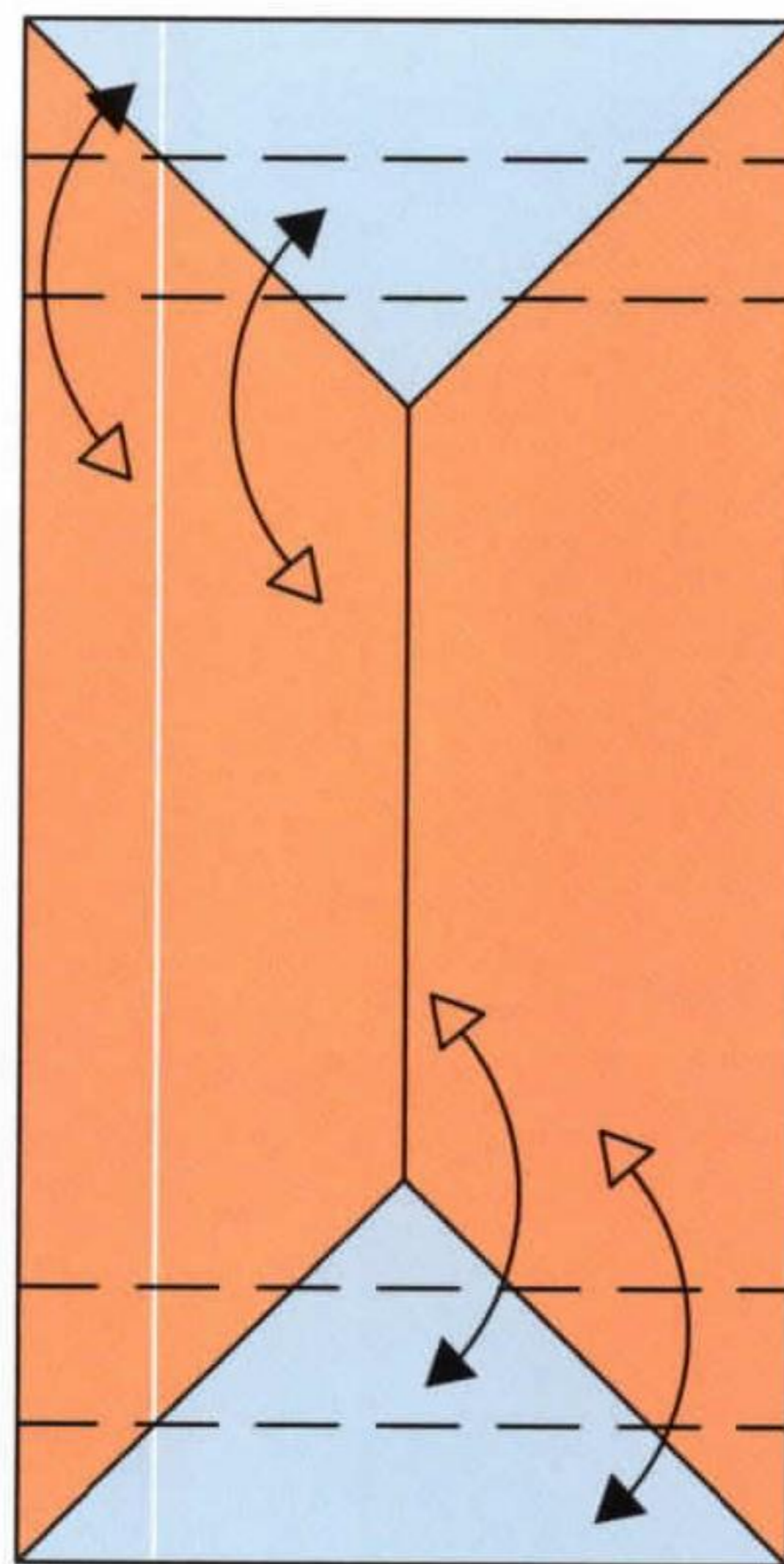

5. Repeat

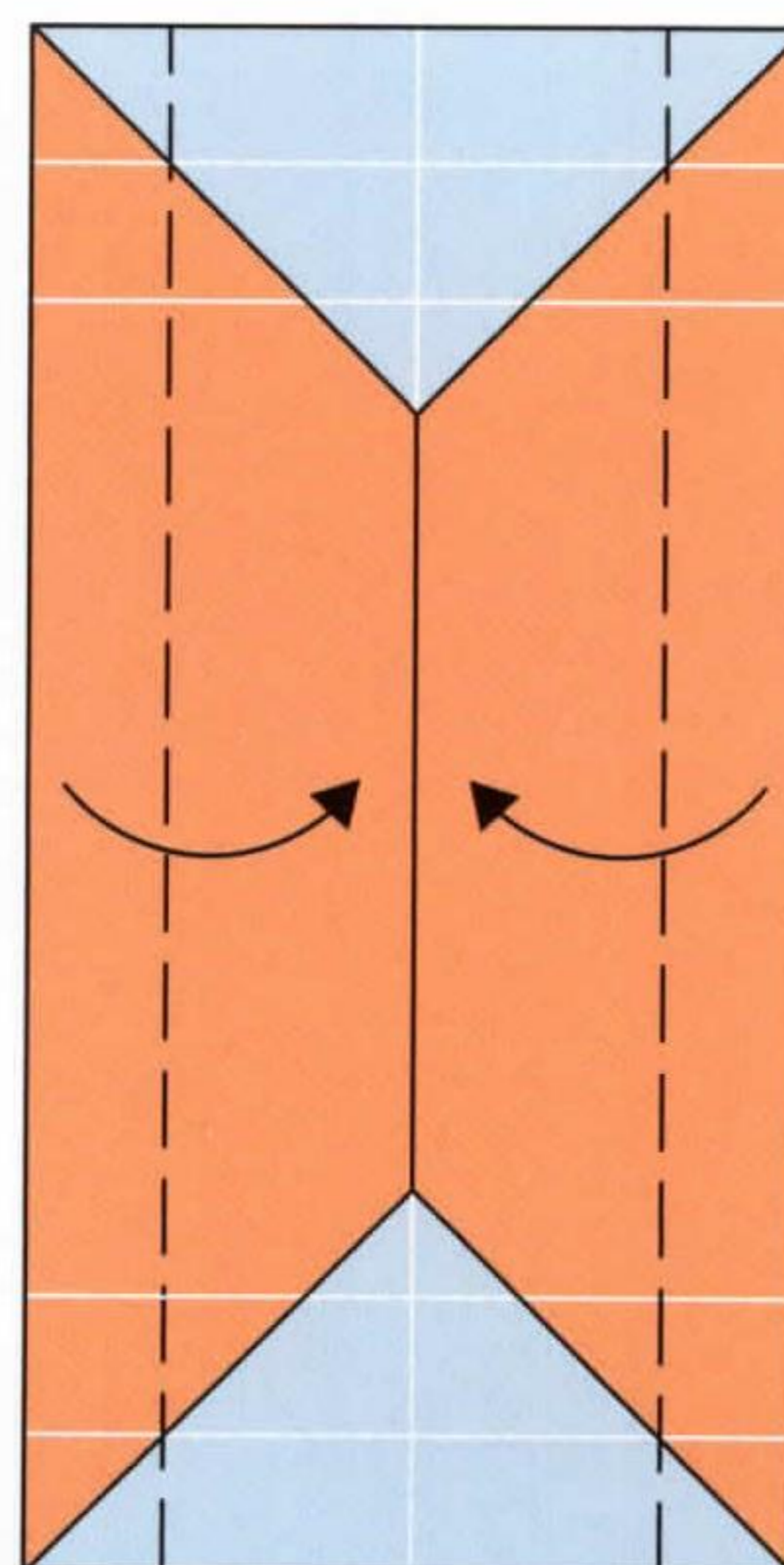

6. Valley folds

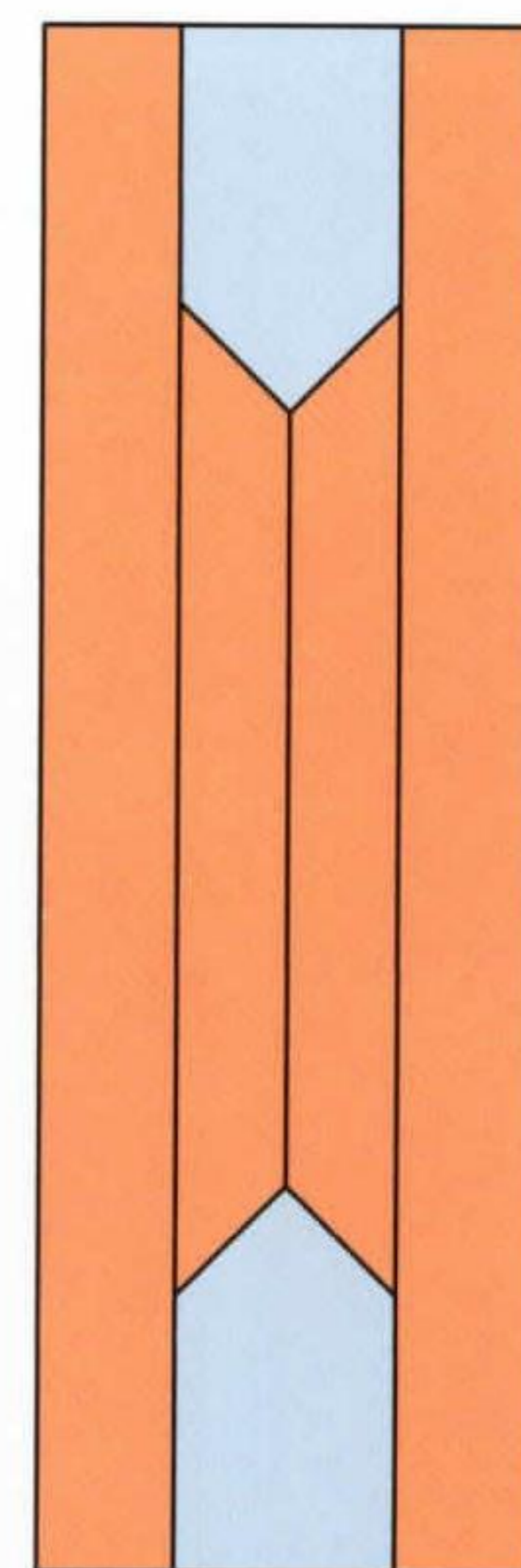

7. Scale-up



wardrobe: part 3

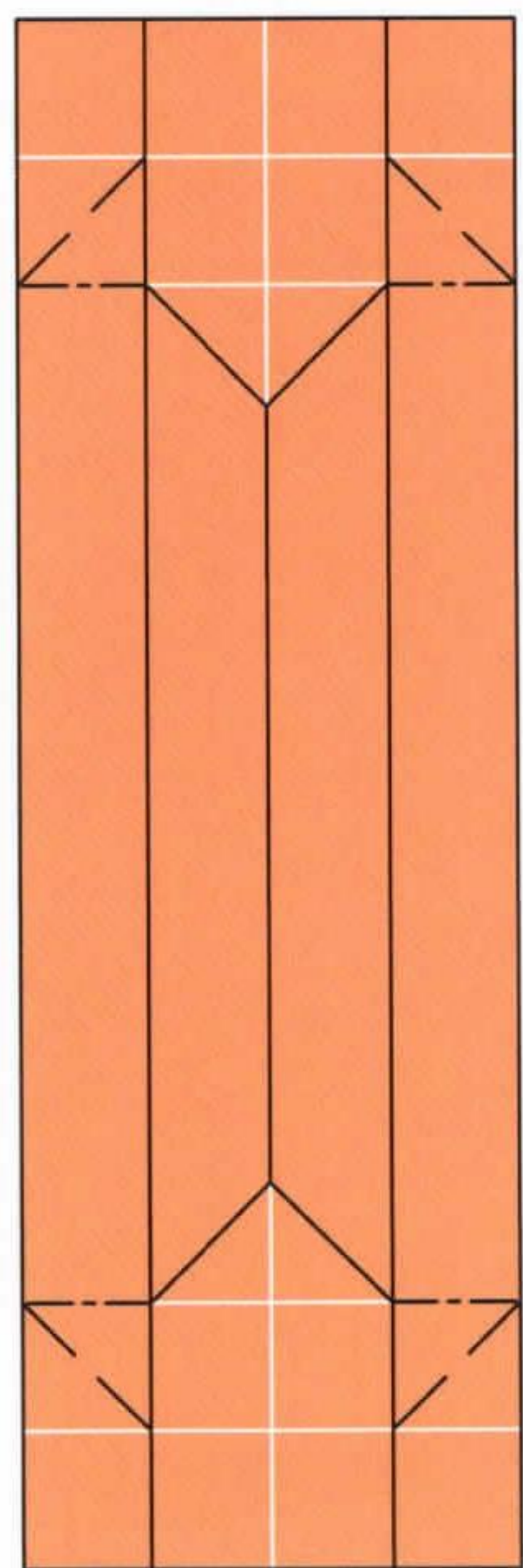

8. Crimp folds

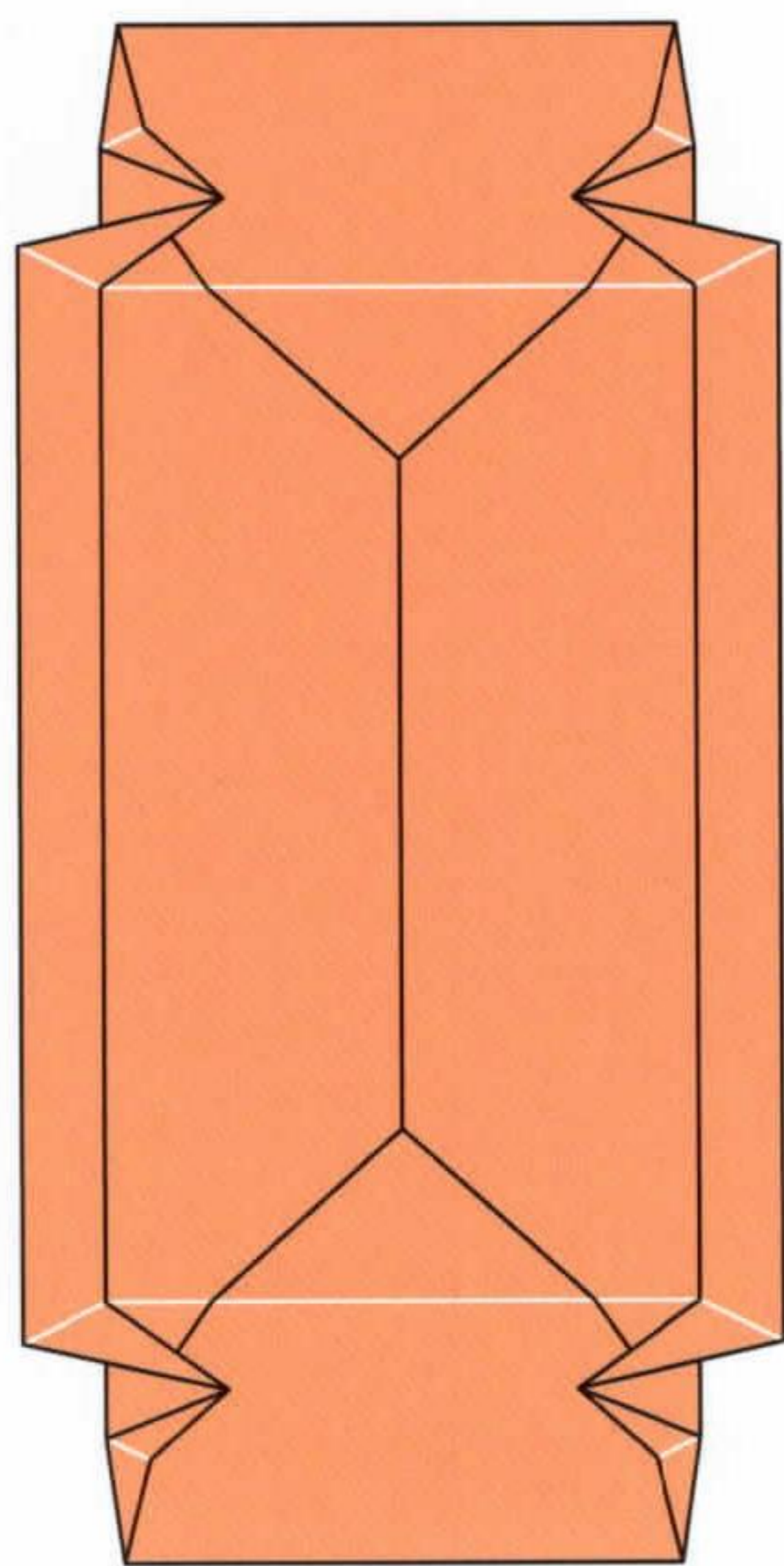

9. Before complete

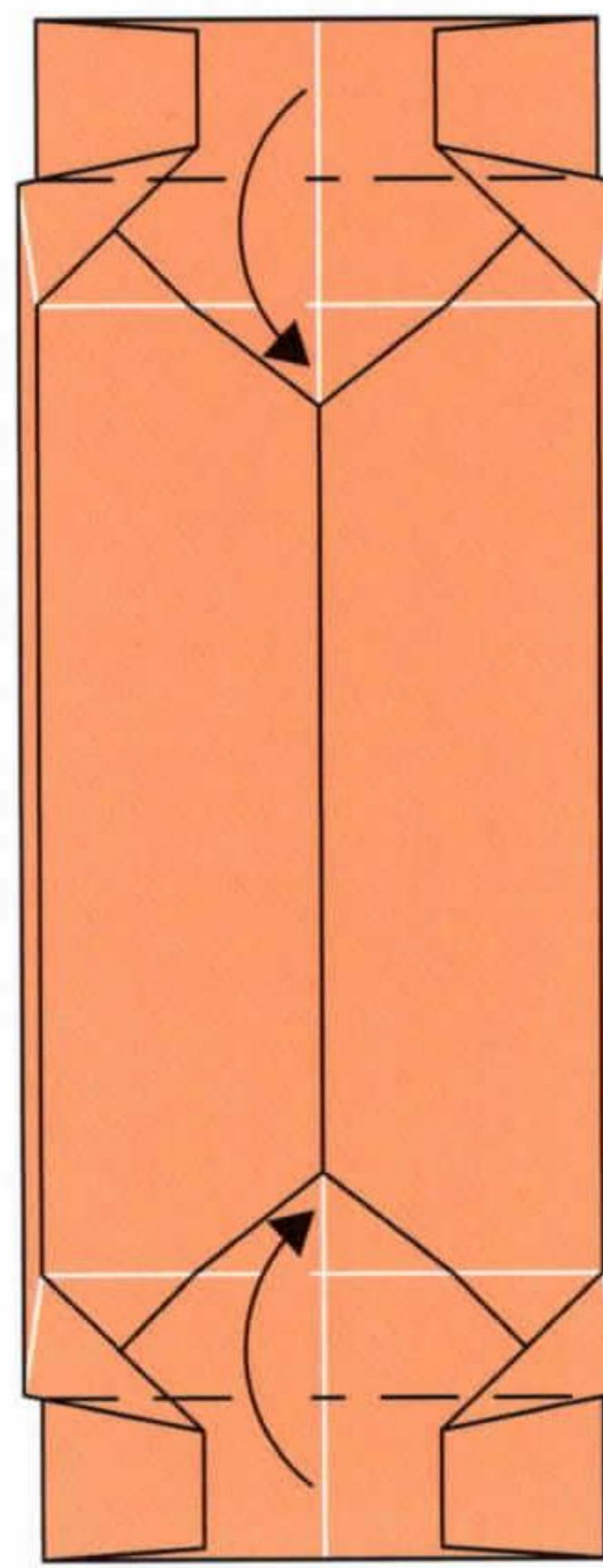

10. Valley folds

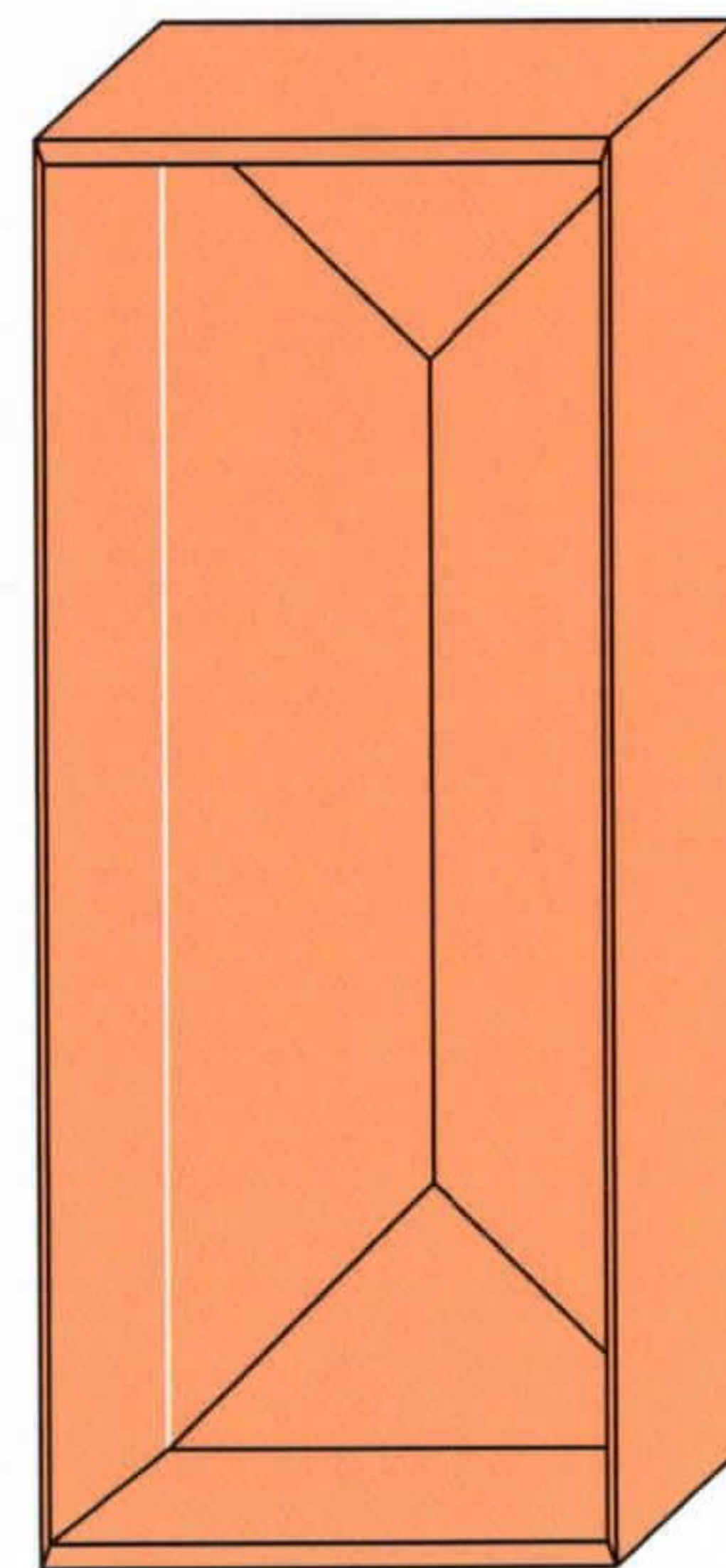

11. Completed
PART 3

FIRST ASSEMBLY

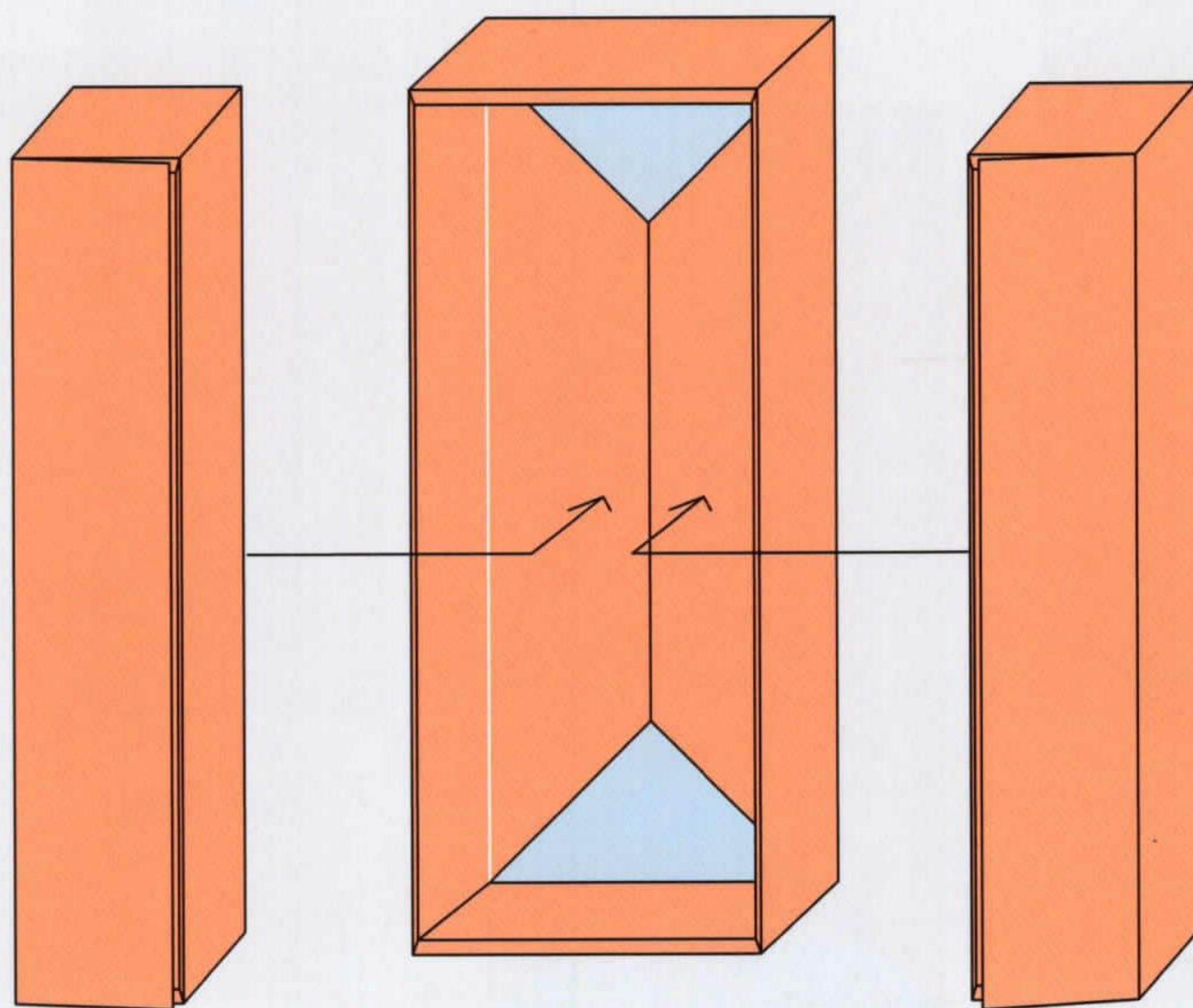

1. Insert all parts together as shown
and apply glue where needed

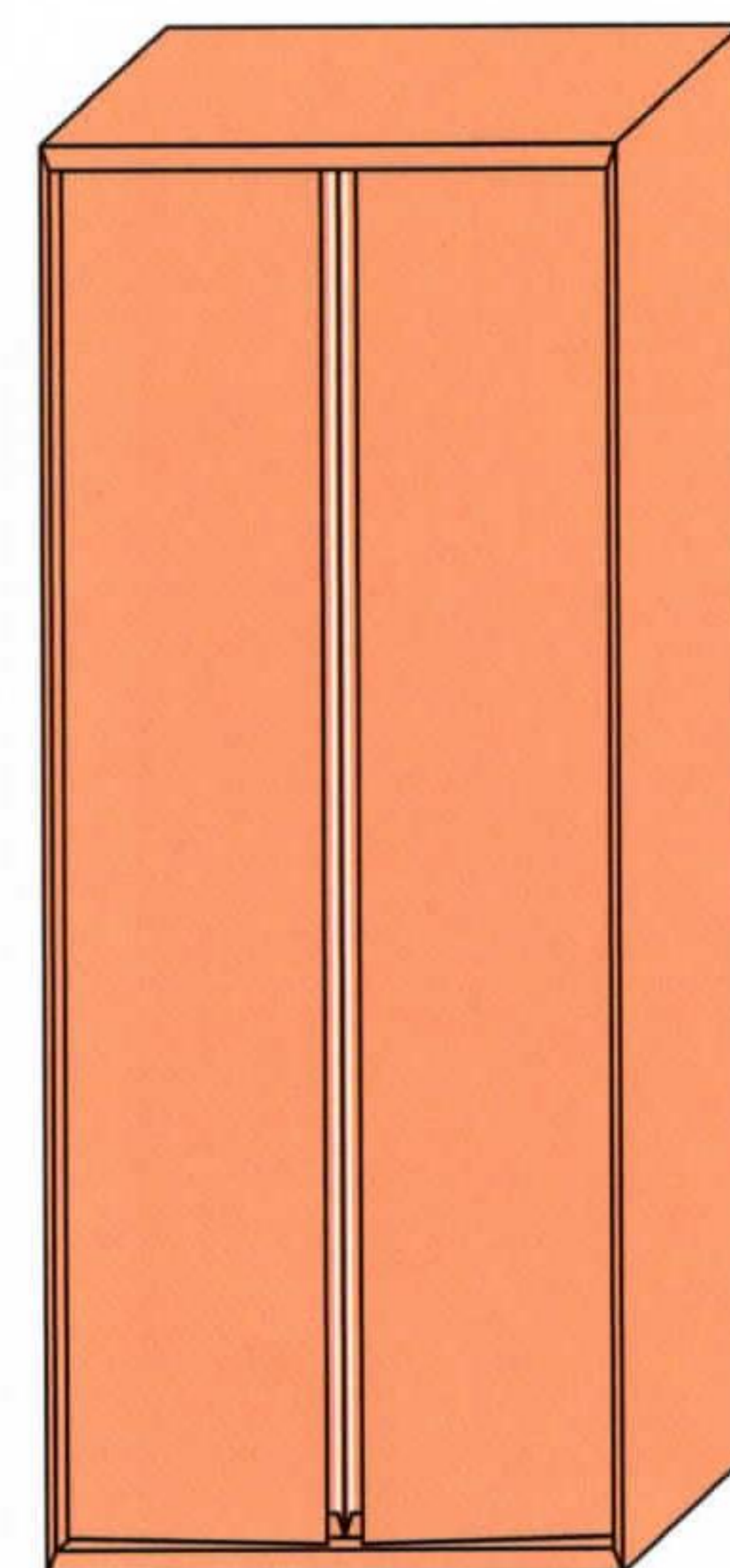

2. Completed
FIRST ASSEMBLY

wardrobe: part 4

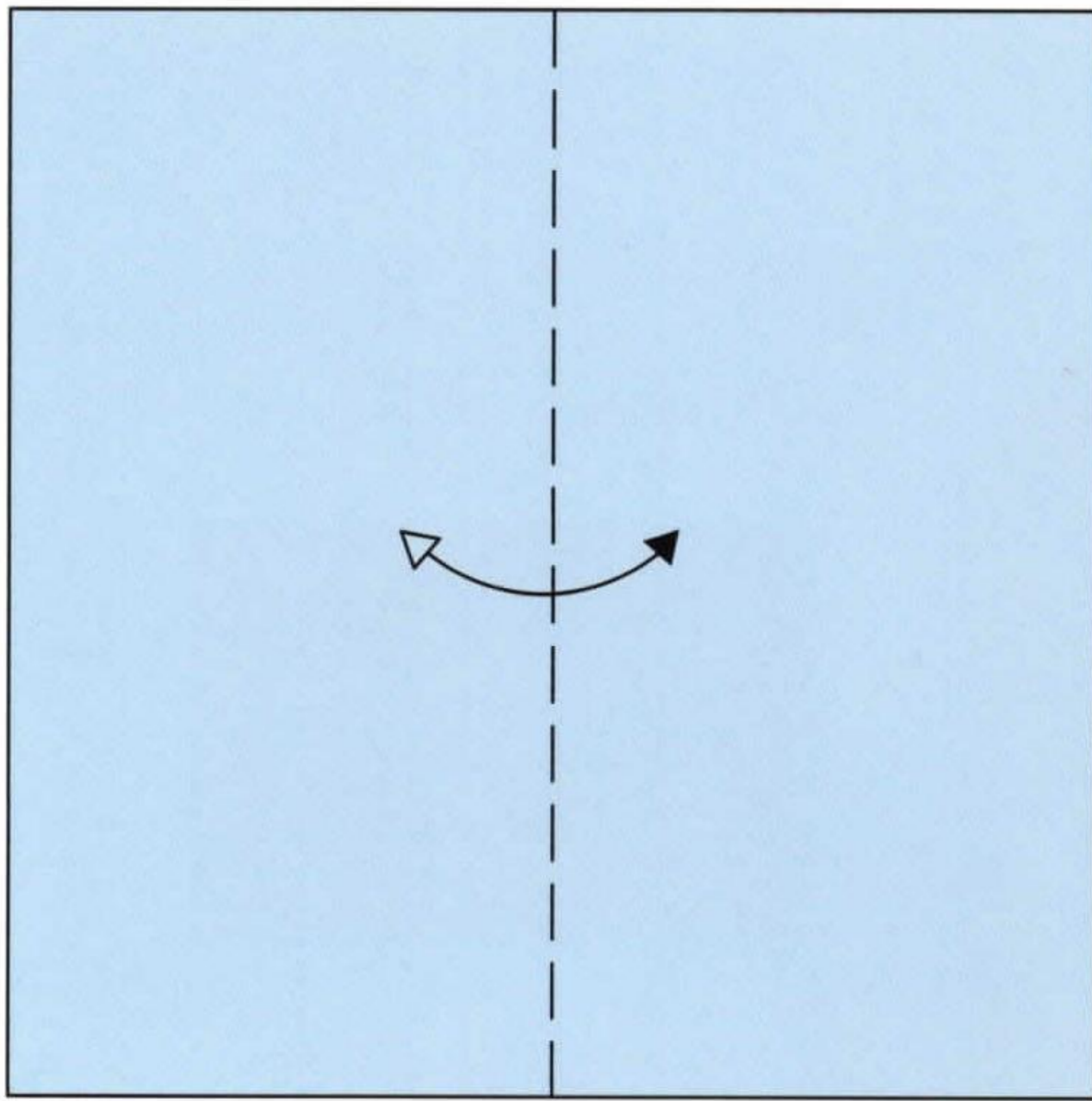

1. Valley fold and unfold

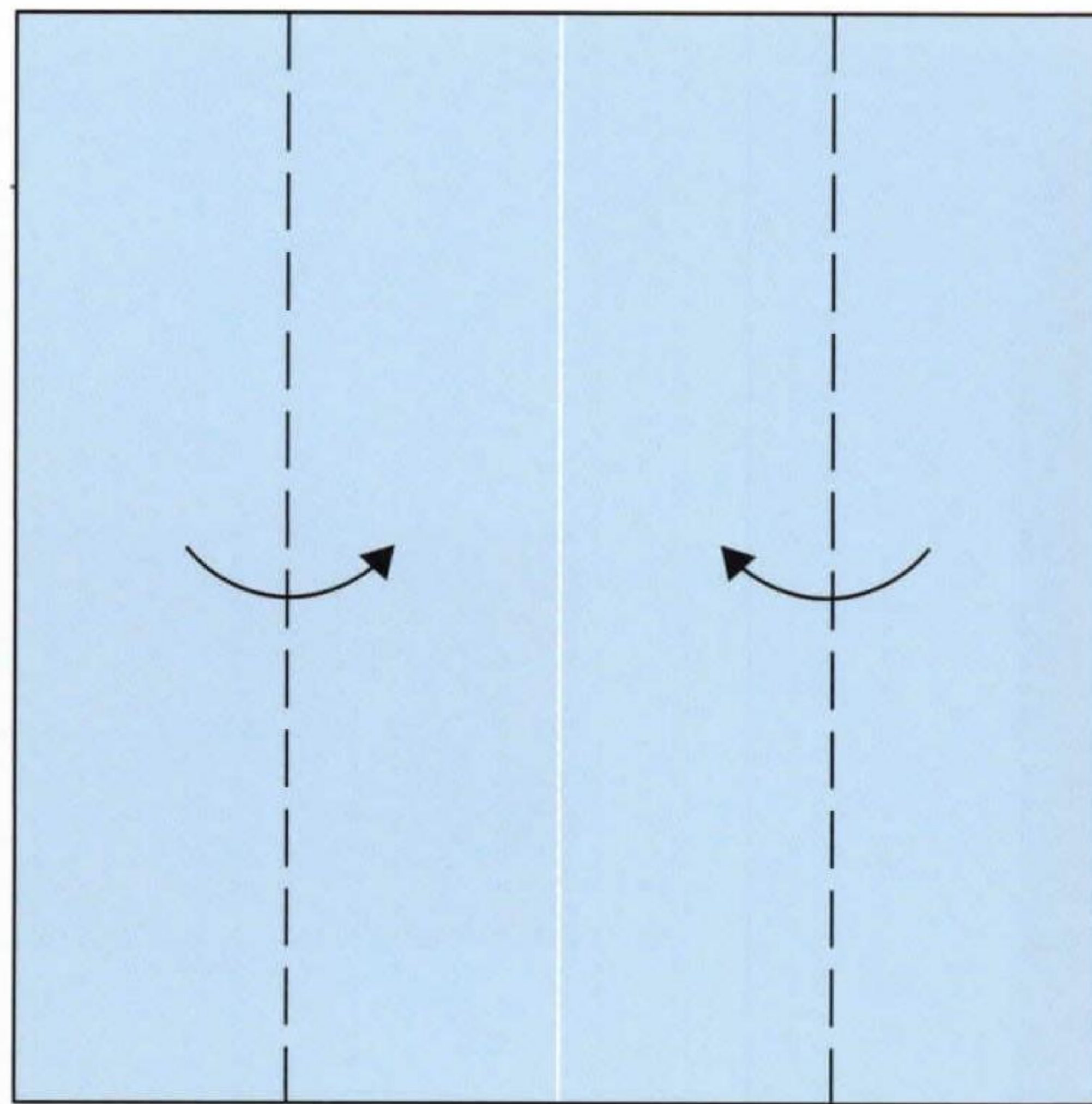

2. Valley folds

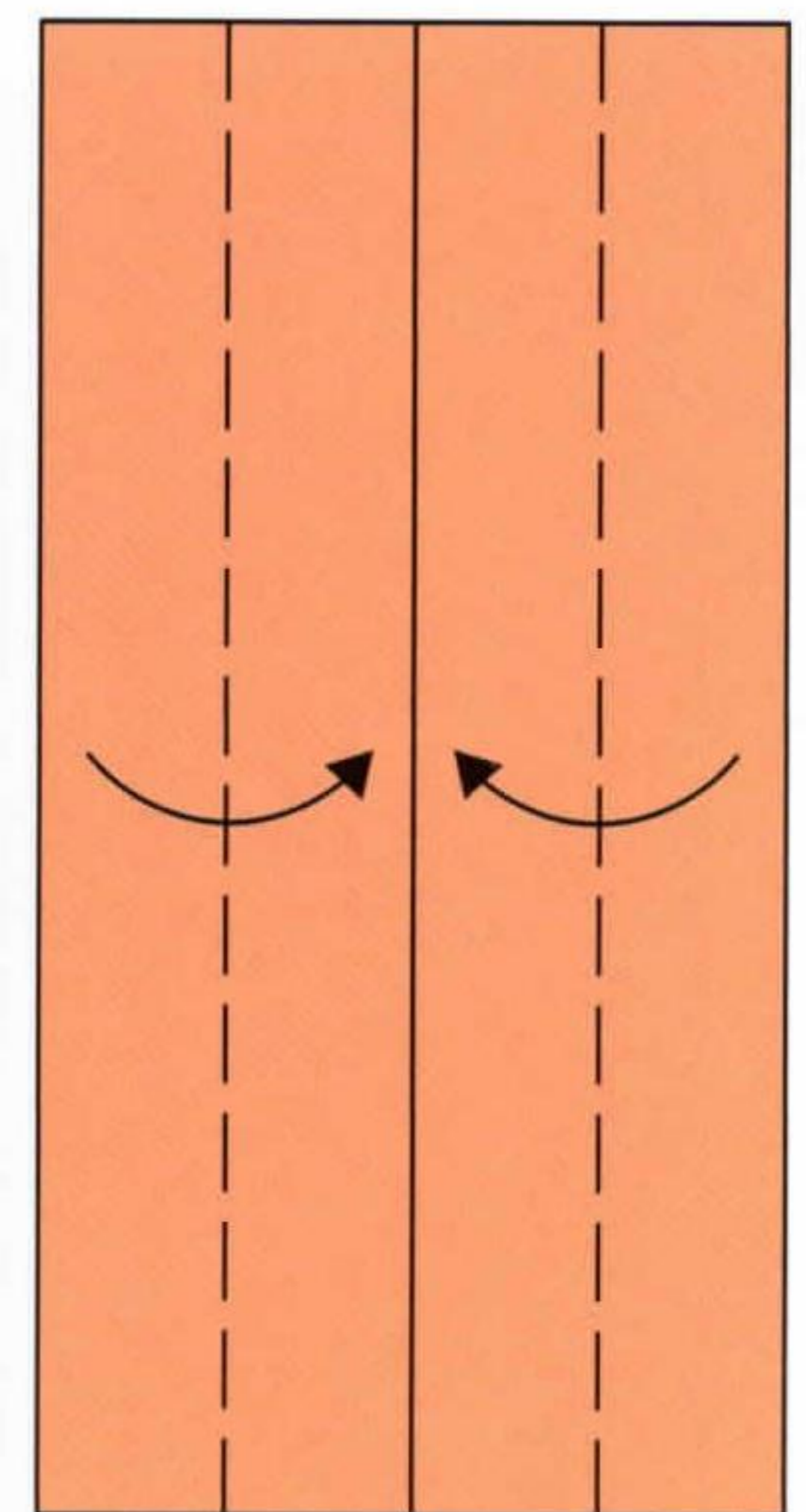

3. Valley folds

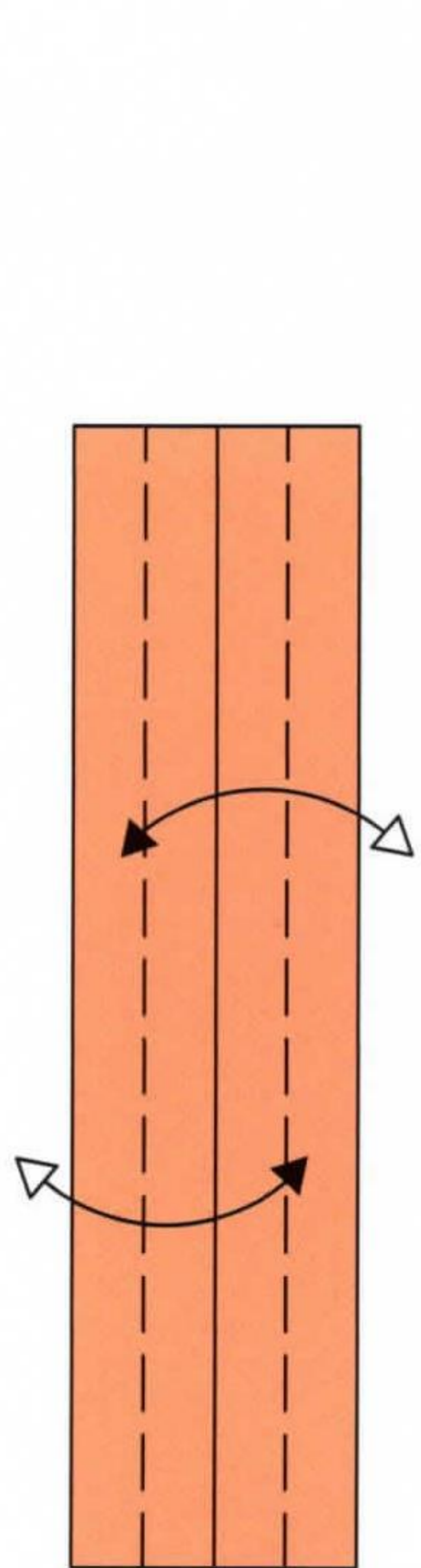

4. Valley folds and unfold

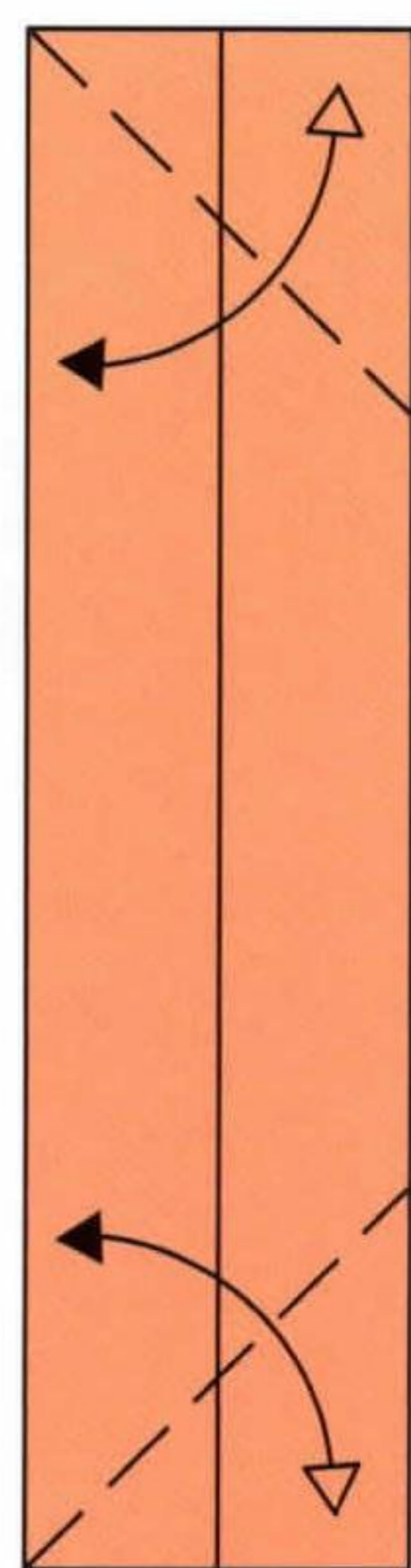

5. Repeat

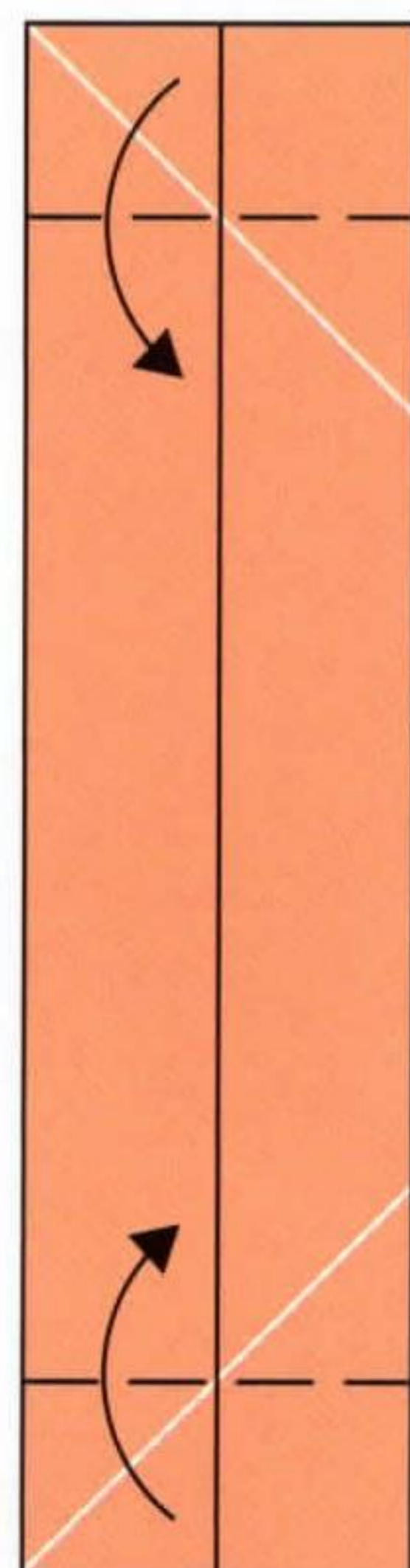

6. Valley folds

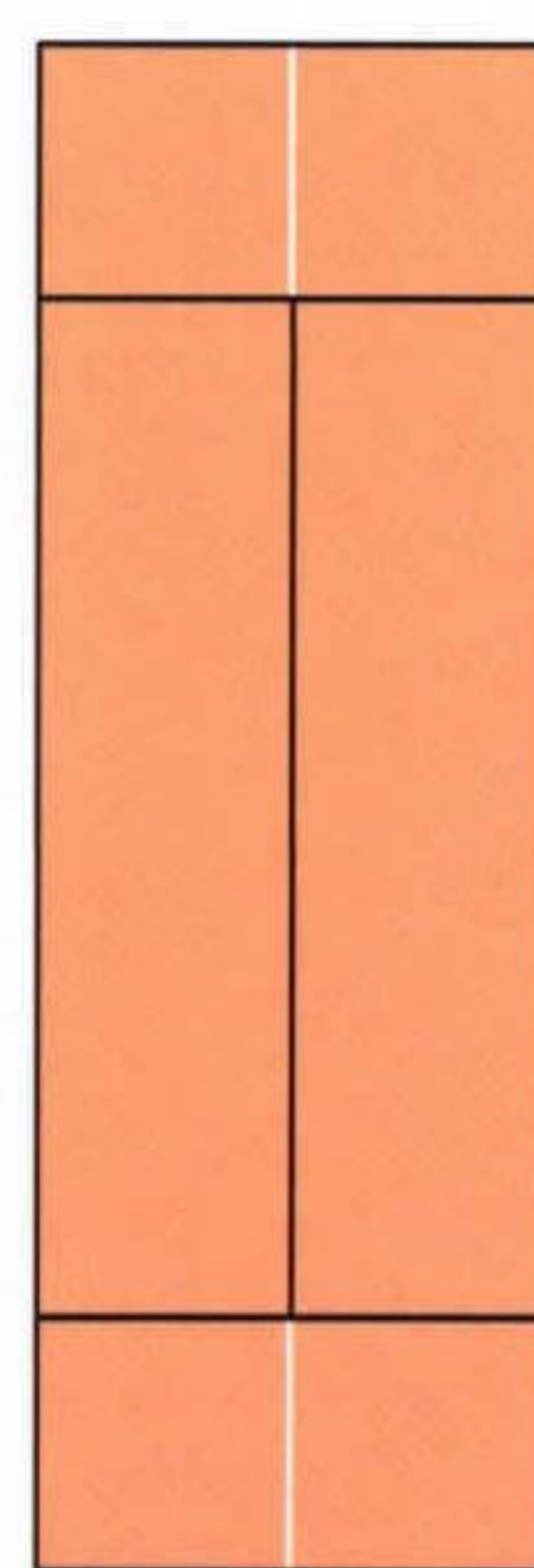

7. Scale-up

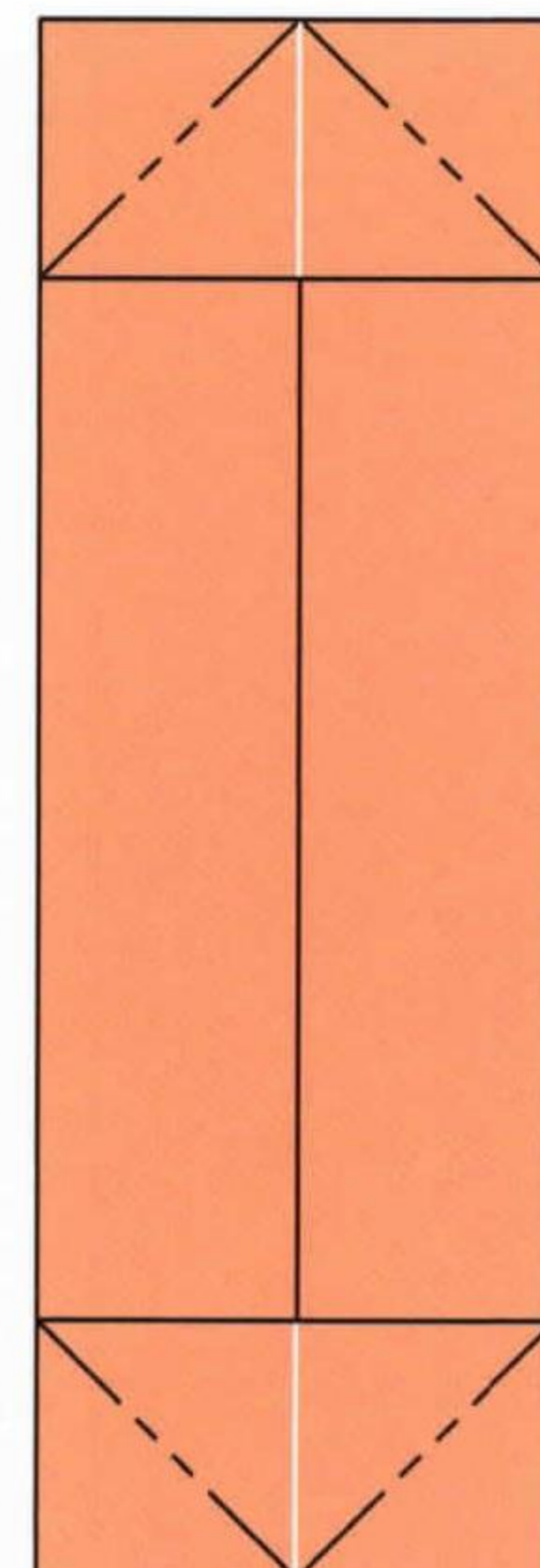

8. Inside reverse folds

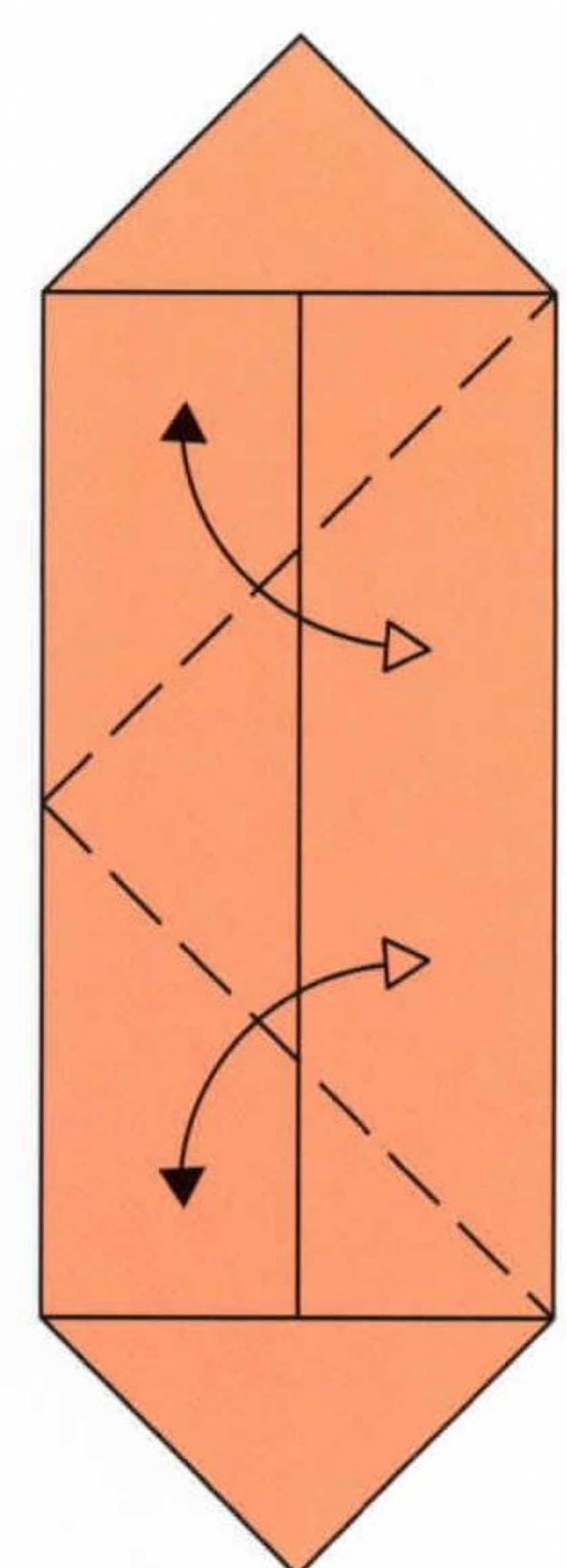

9. Valley folds unfold

wardrobe: part 4

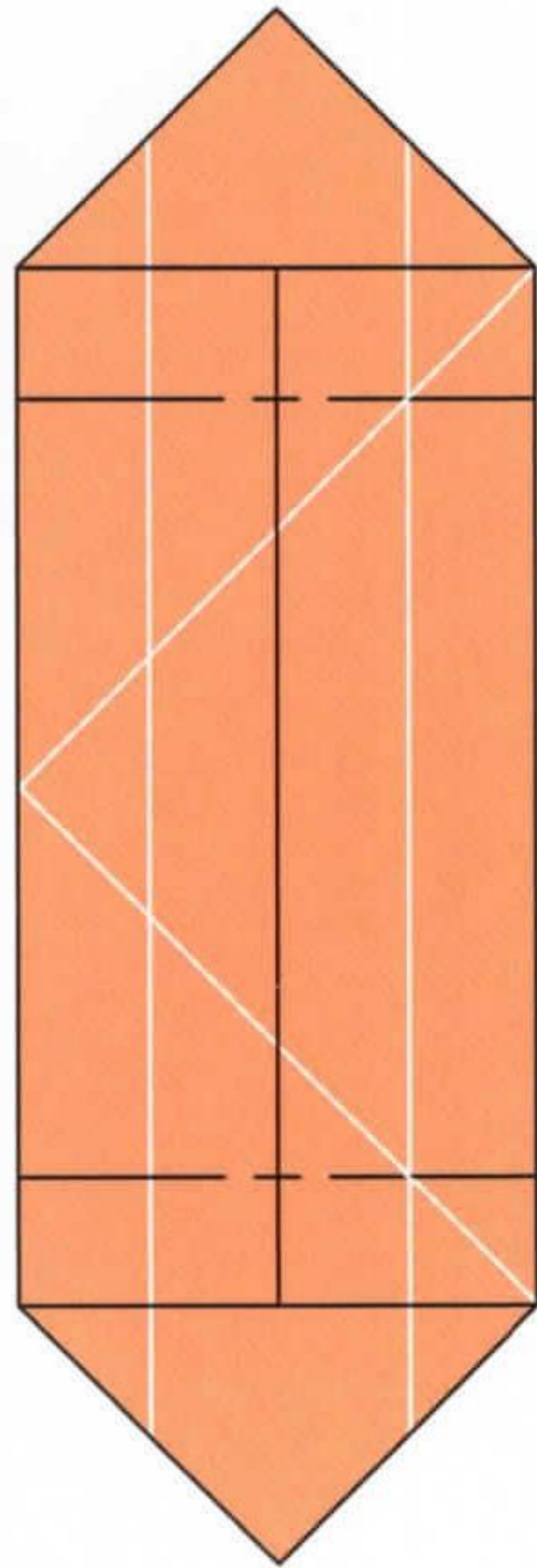

10. Mountain folds and rotate

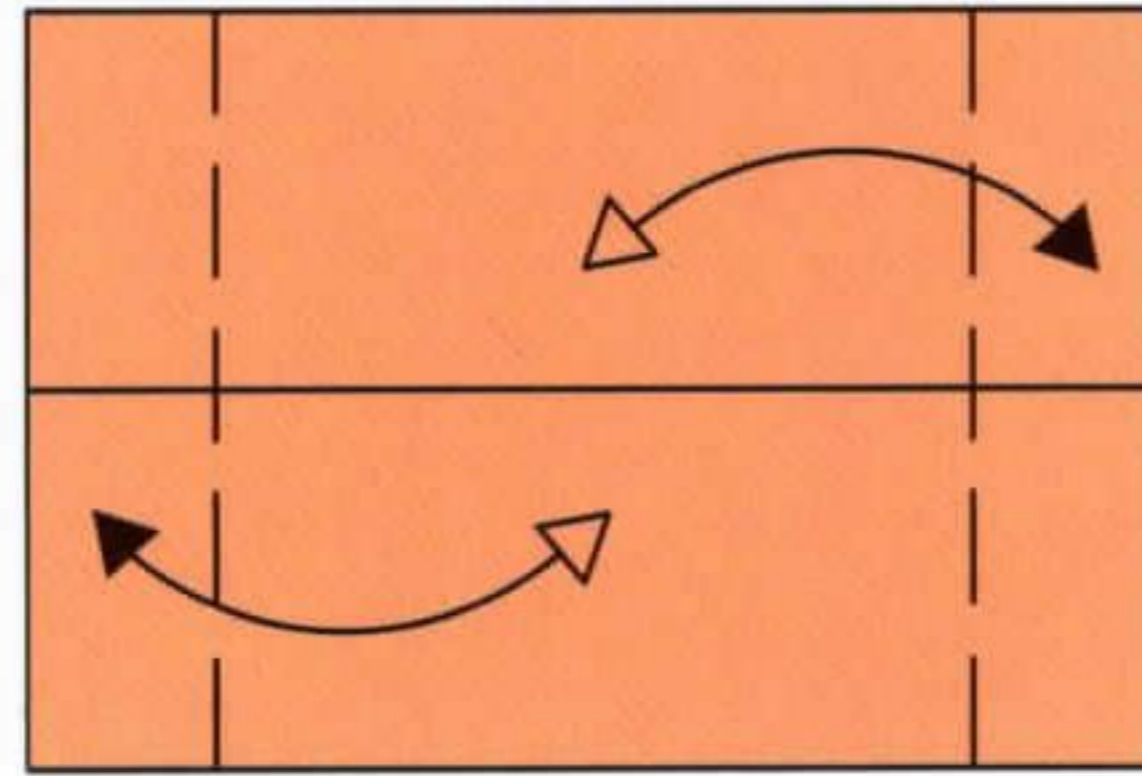

11. Valley folds and unfold

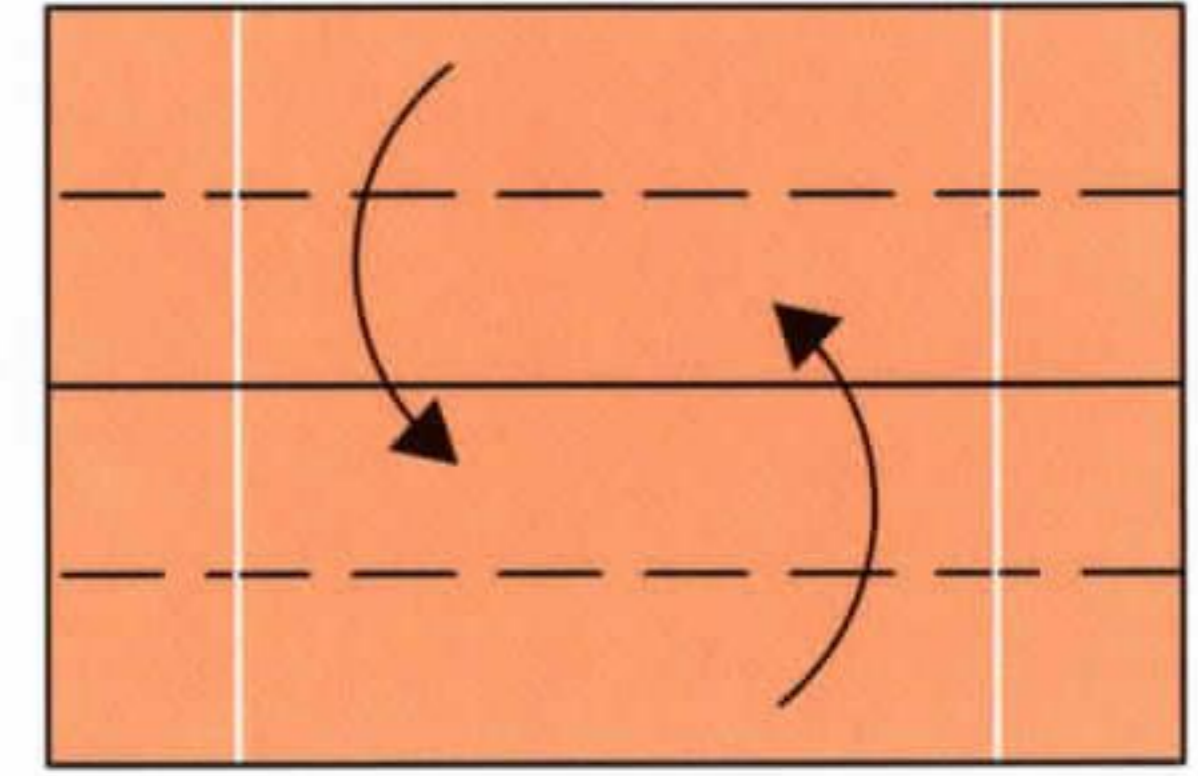

12. Valley folds

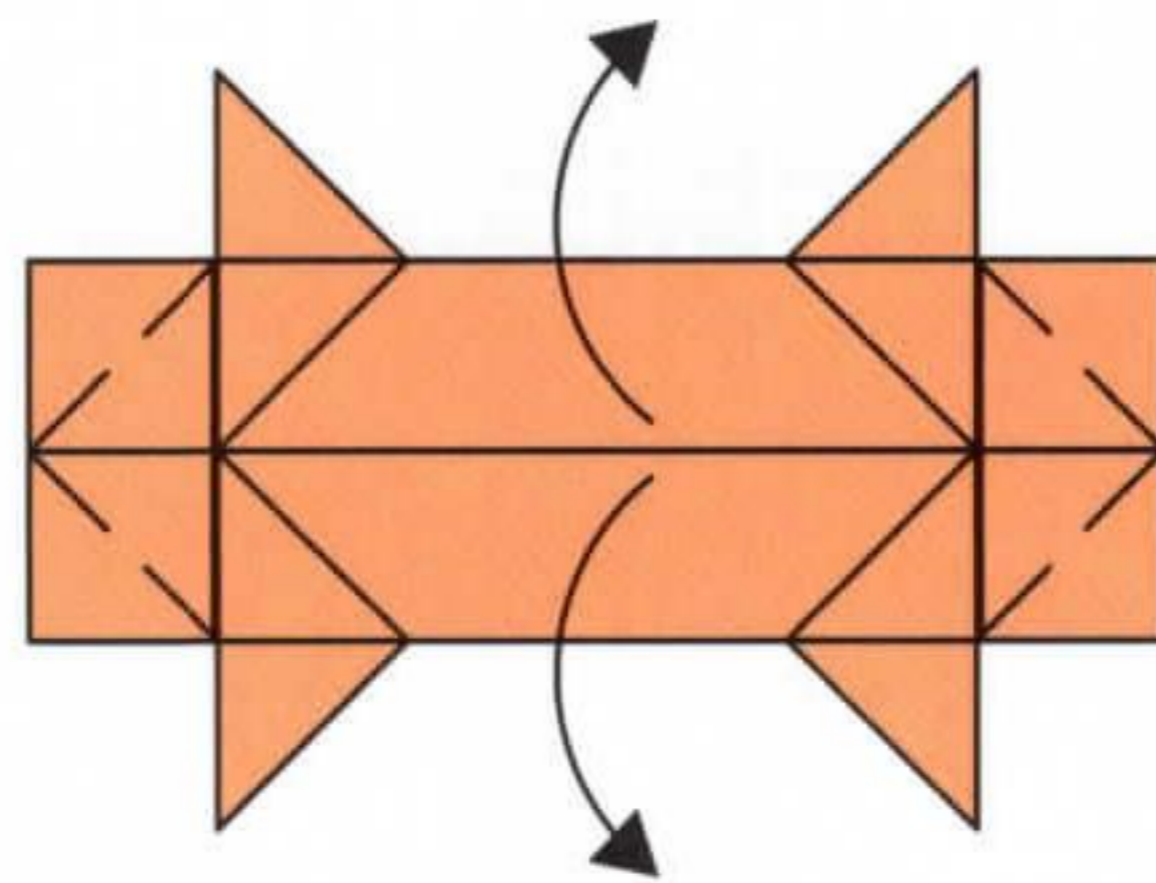

13. Crimp folds

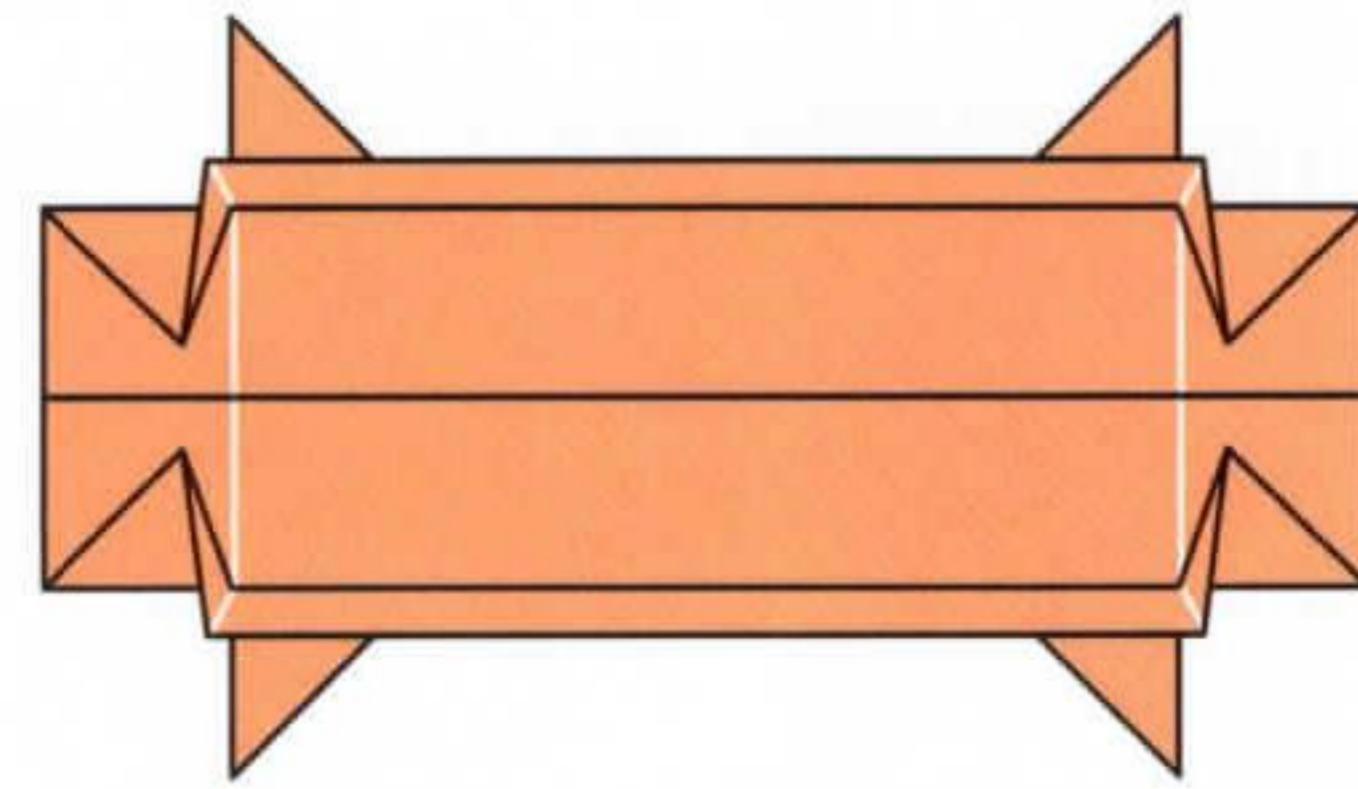

14. Before complete

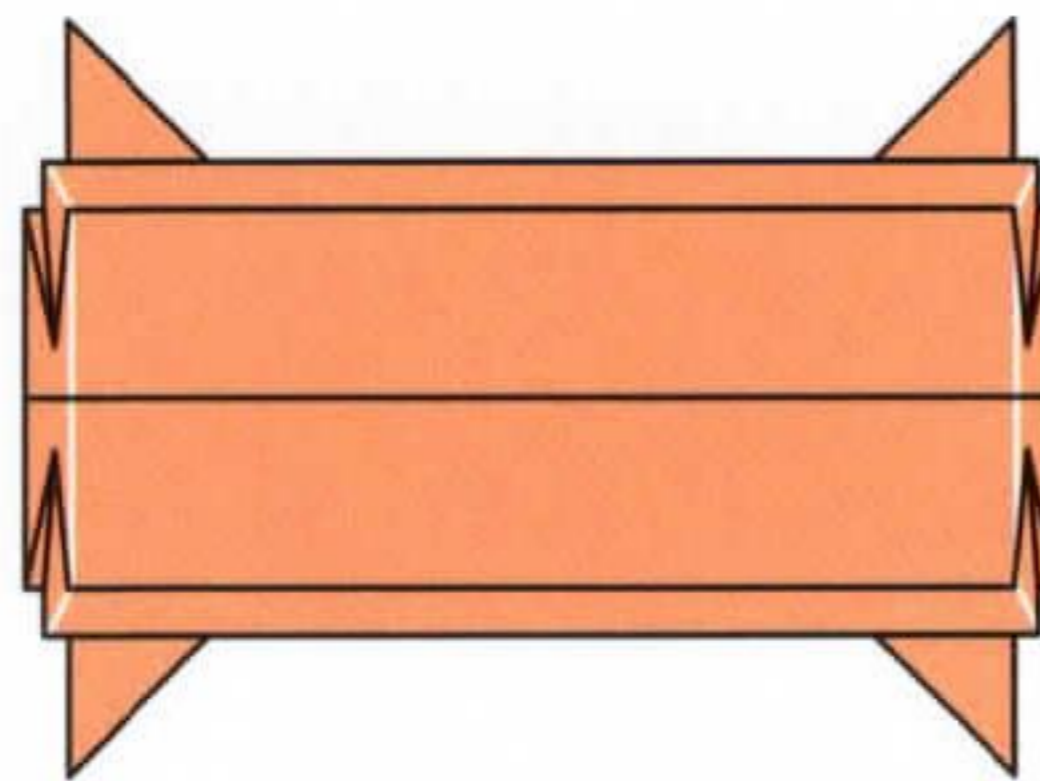

15. Rotate

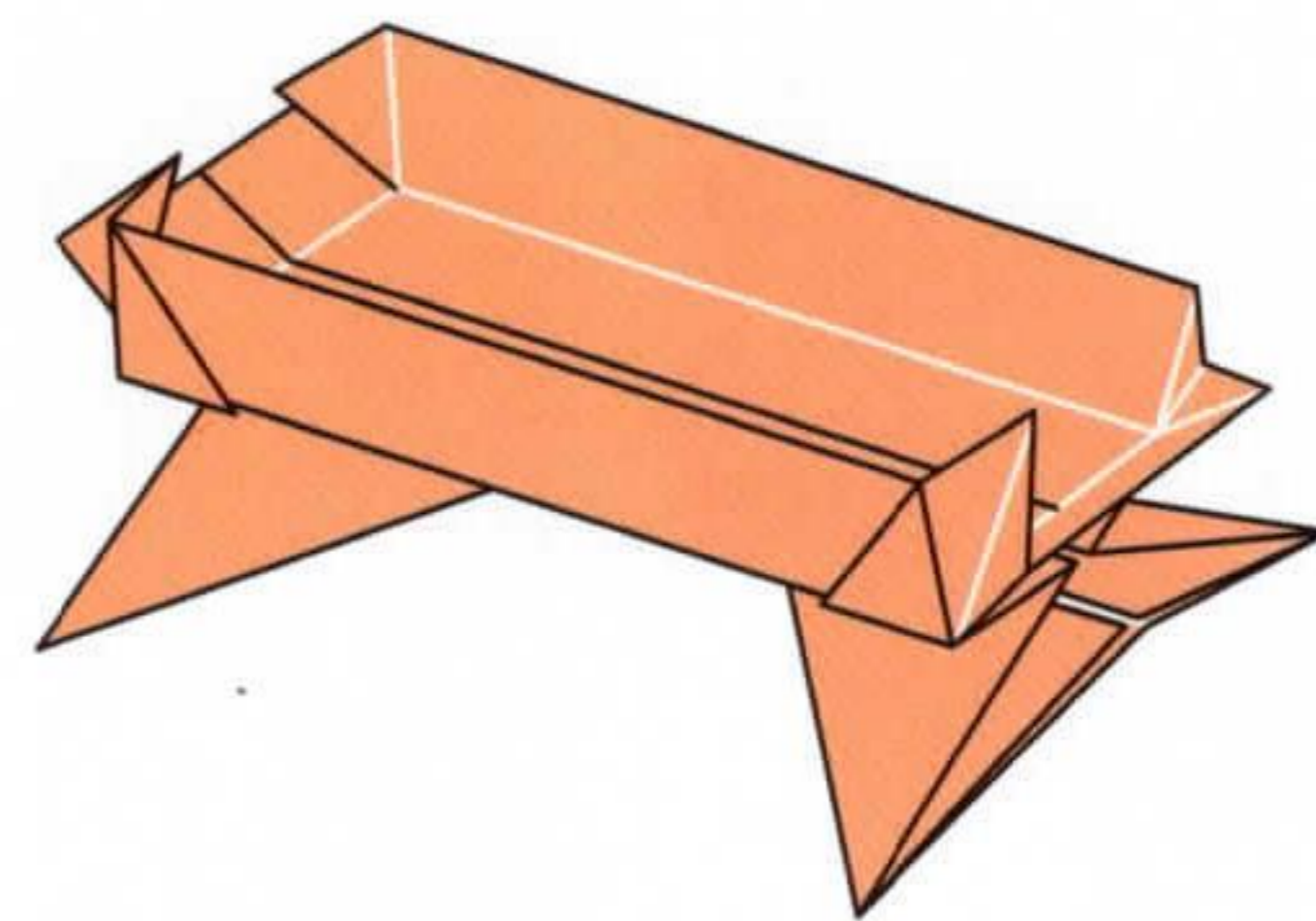

16. Completed
PART 4

wardrobe: complete

SECOND ASSEMBLY

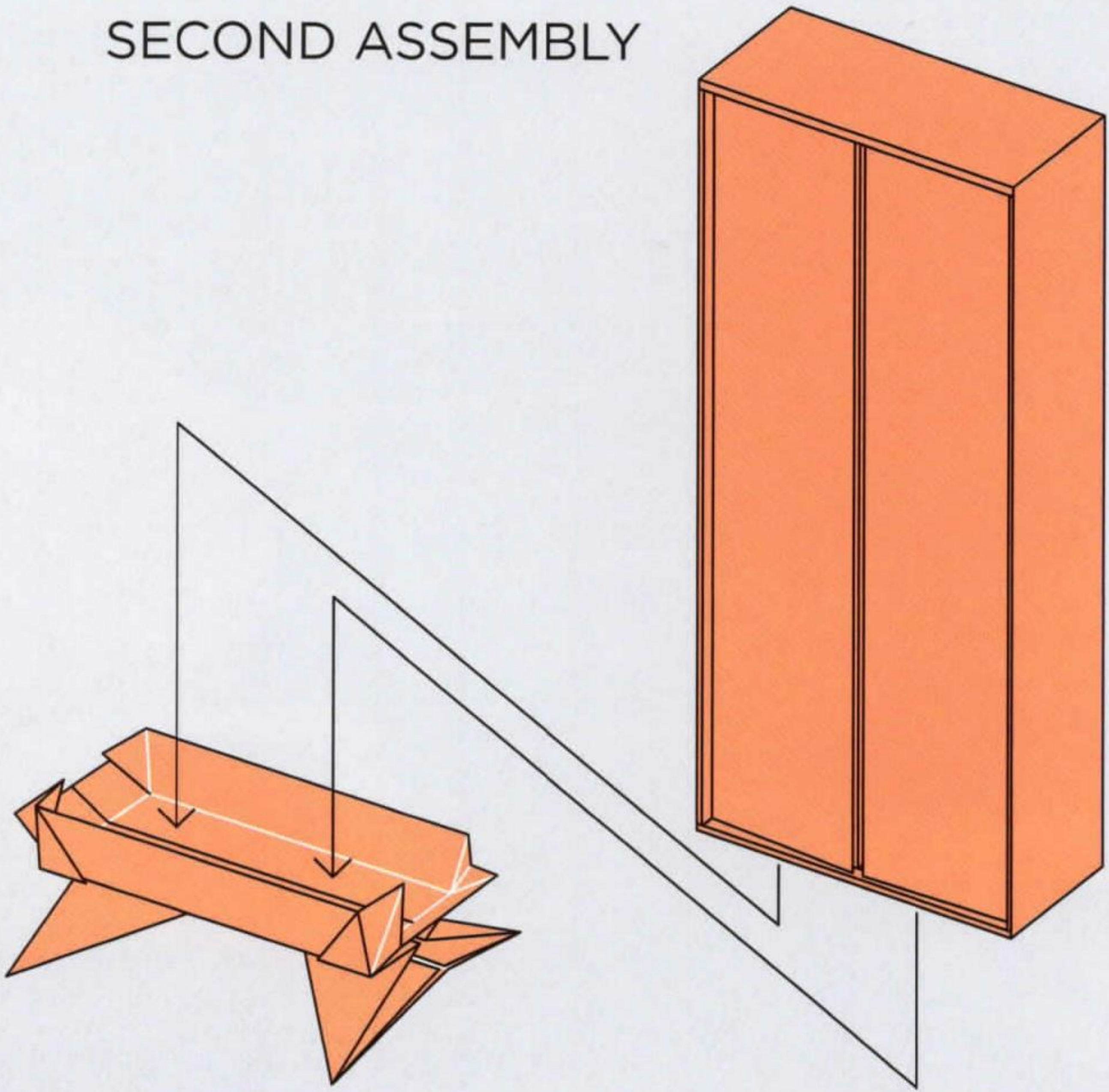

1. Join all parts together as shown and apply glue to hold

2. Completed WARDROBE

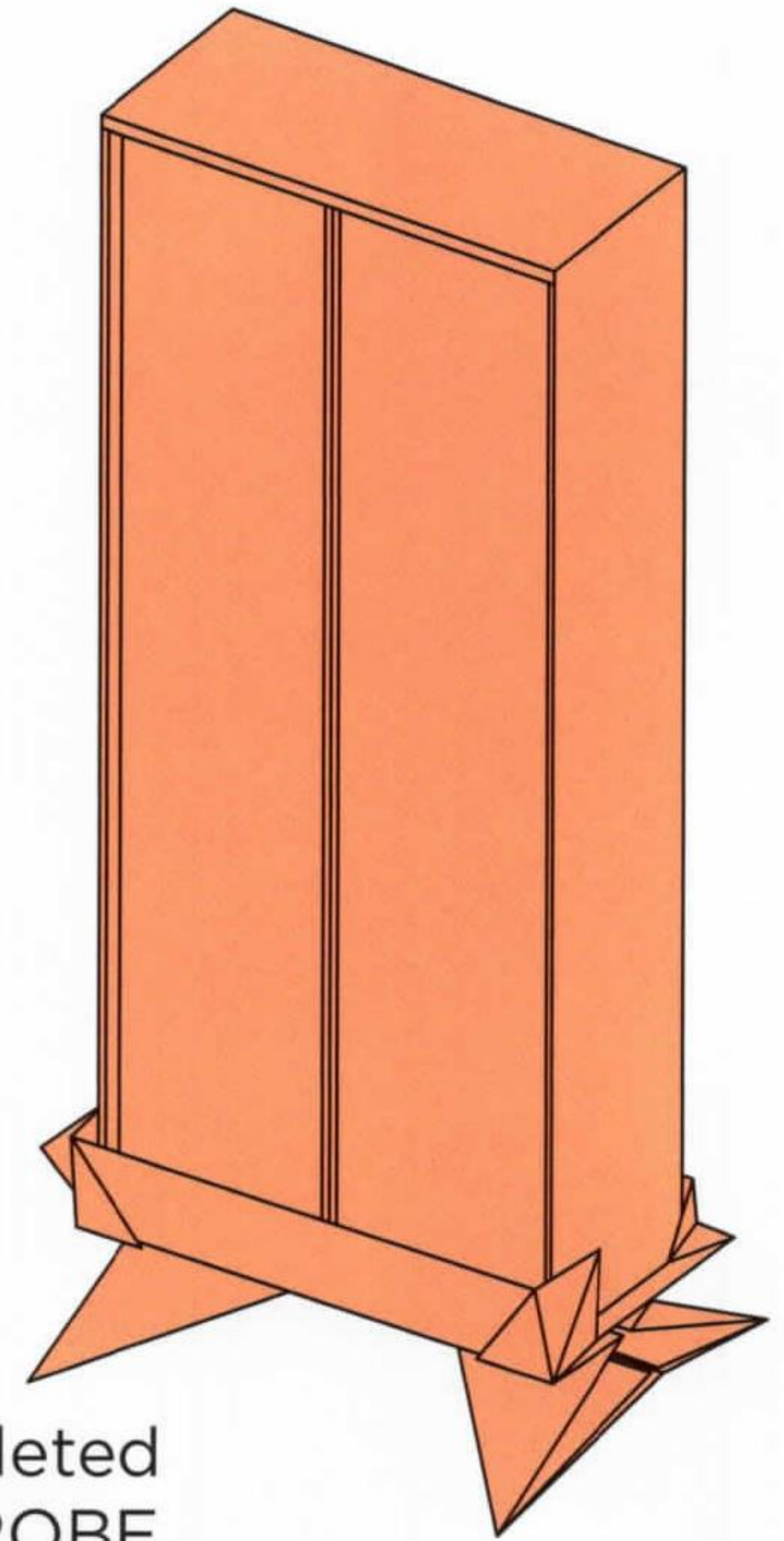



sink (basin)

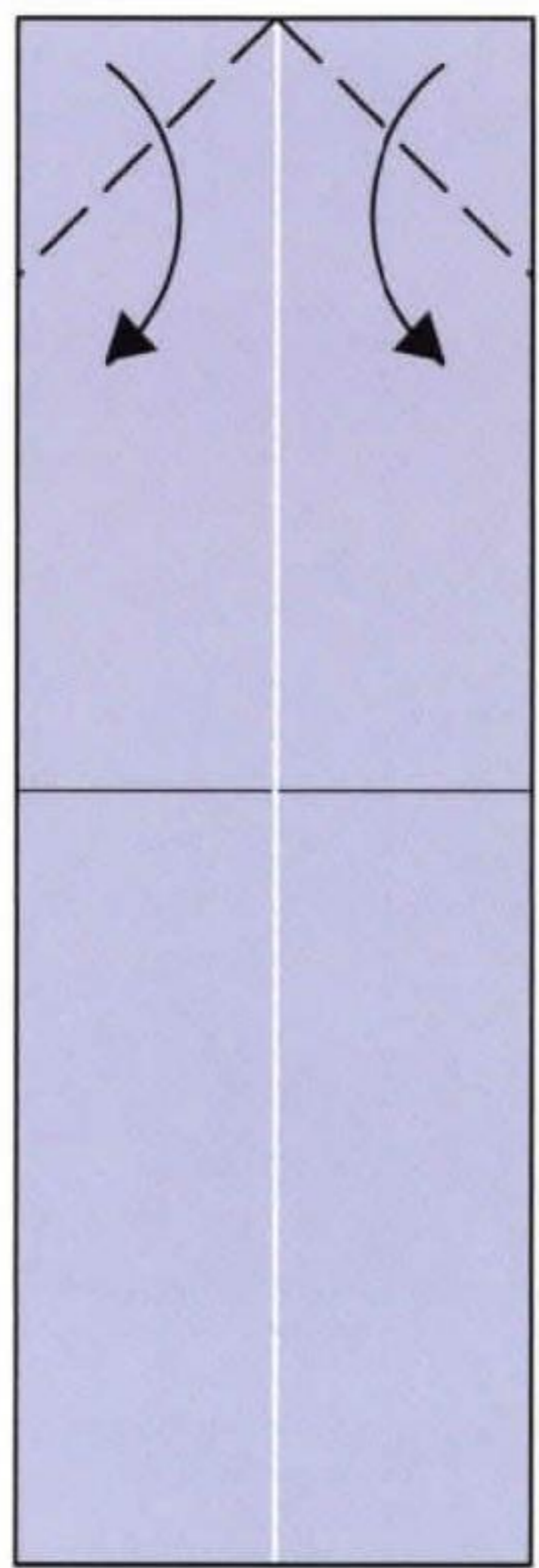

10. Valley folds

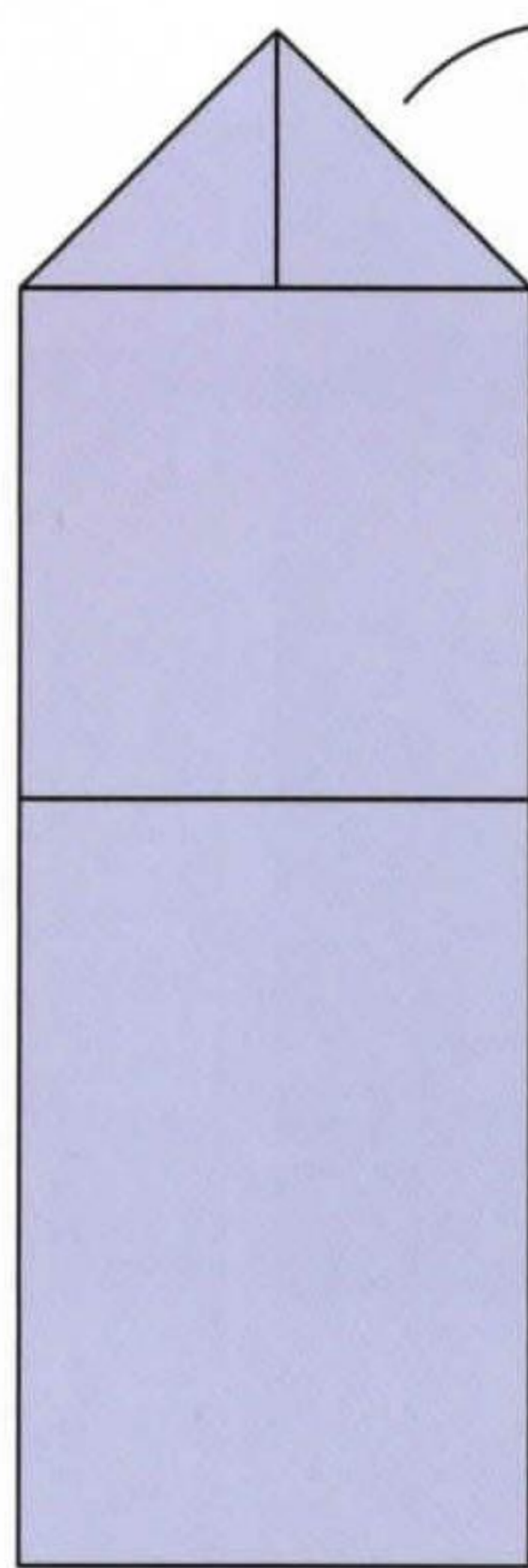

11. Turn over

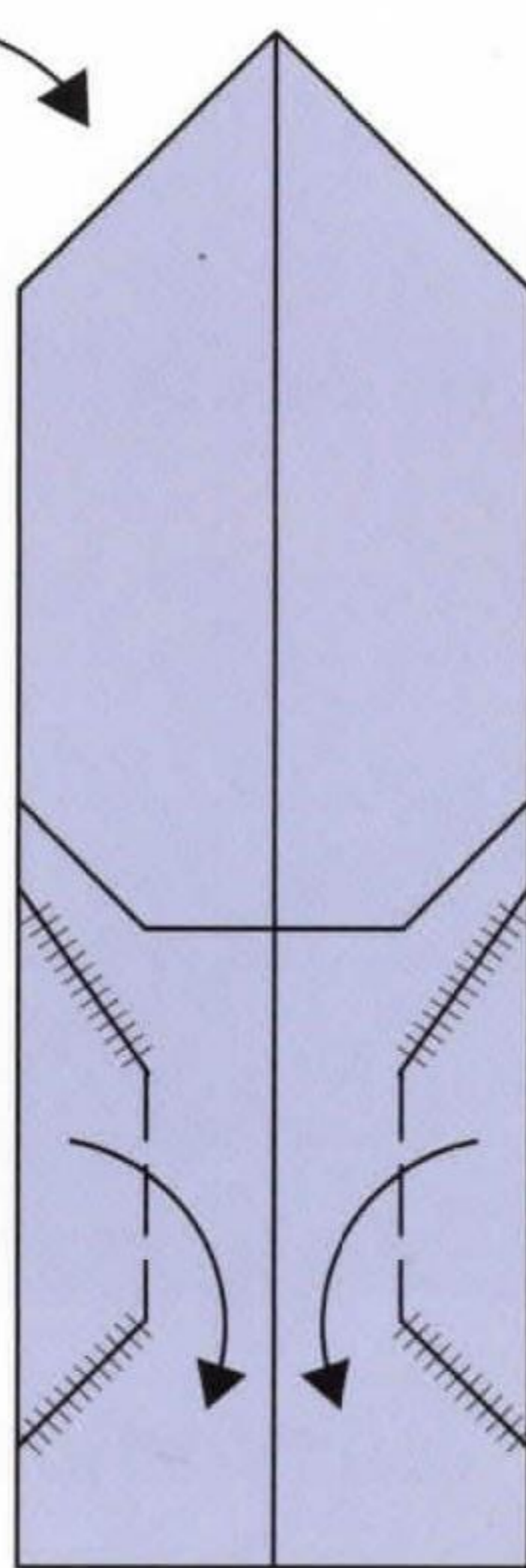

12. Cuts and valley folds

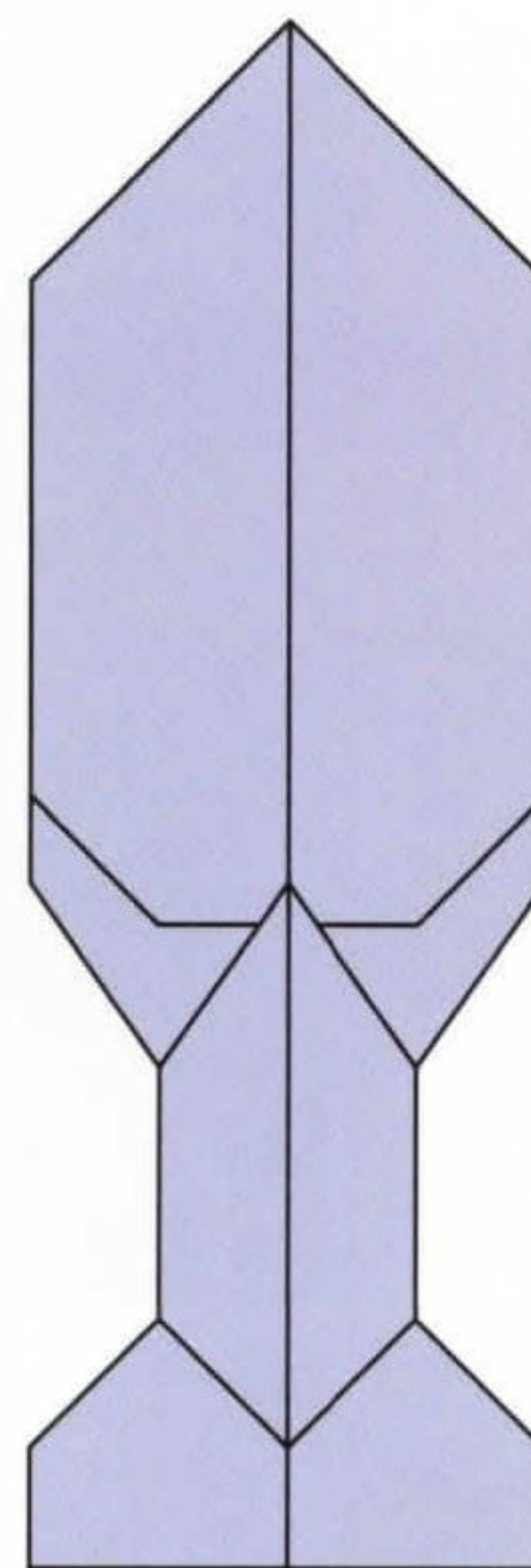

13. Hide behind

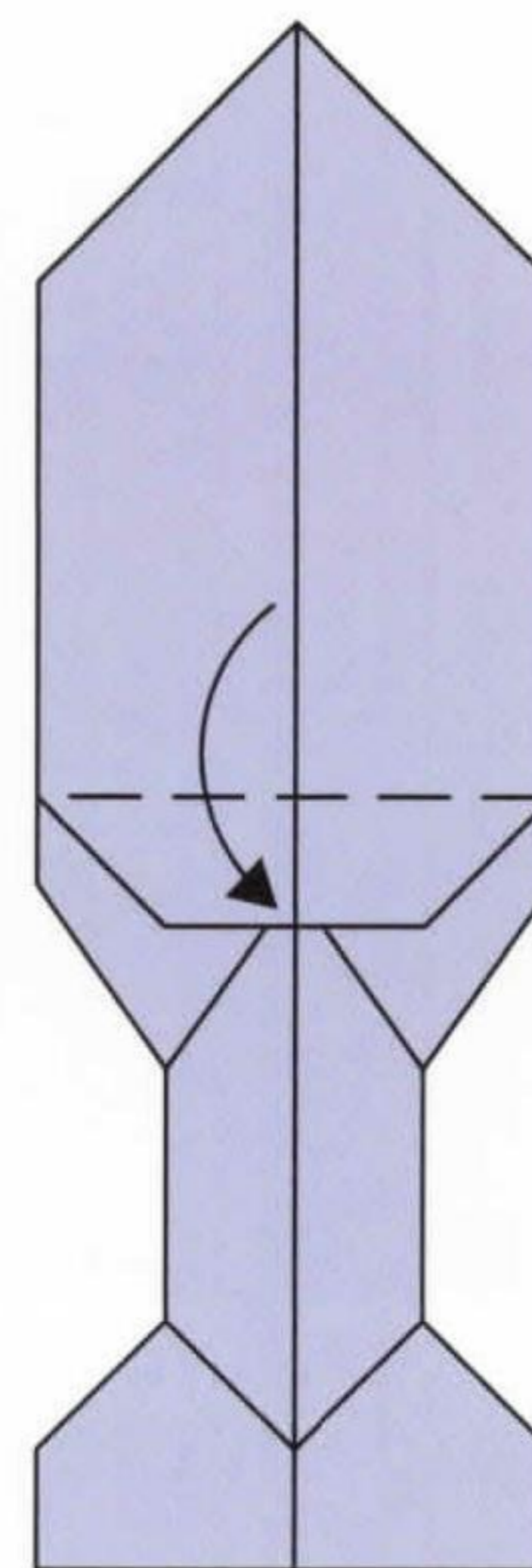

14. Valley fold

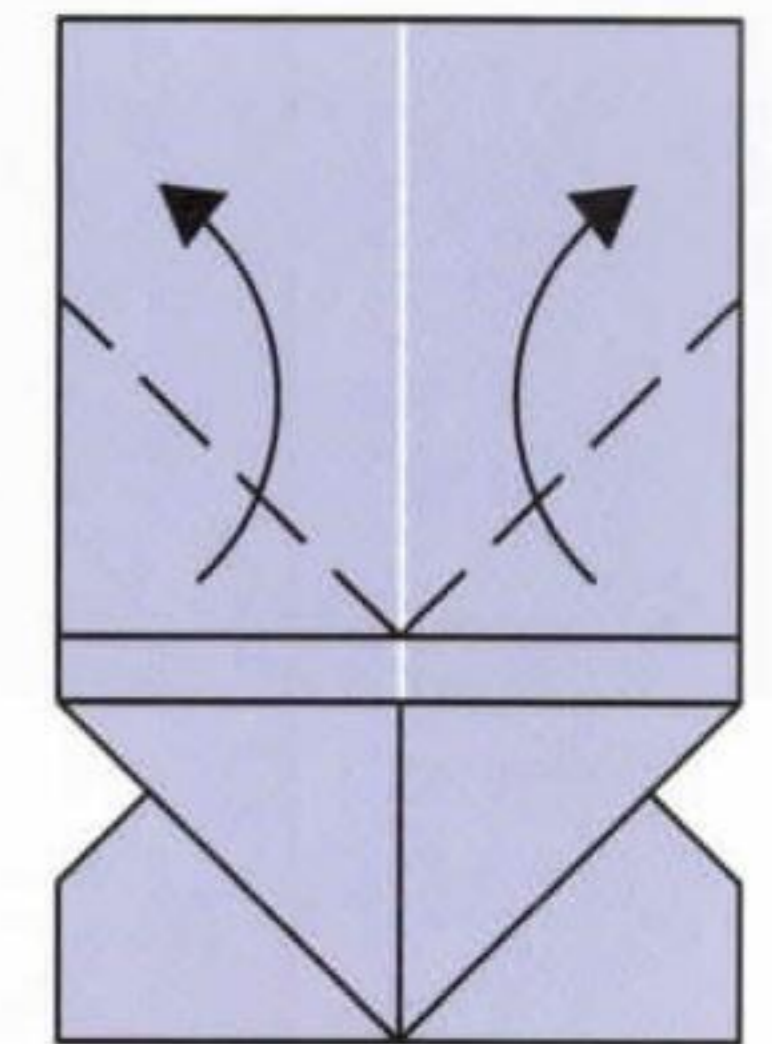

15. Crimp folds

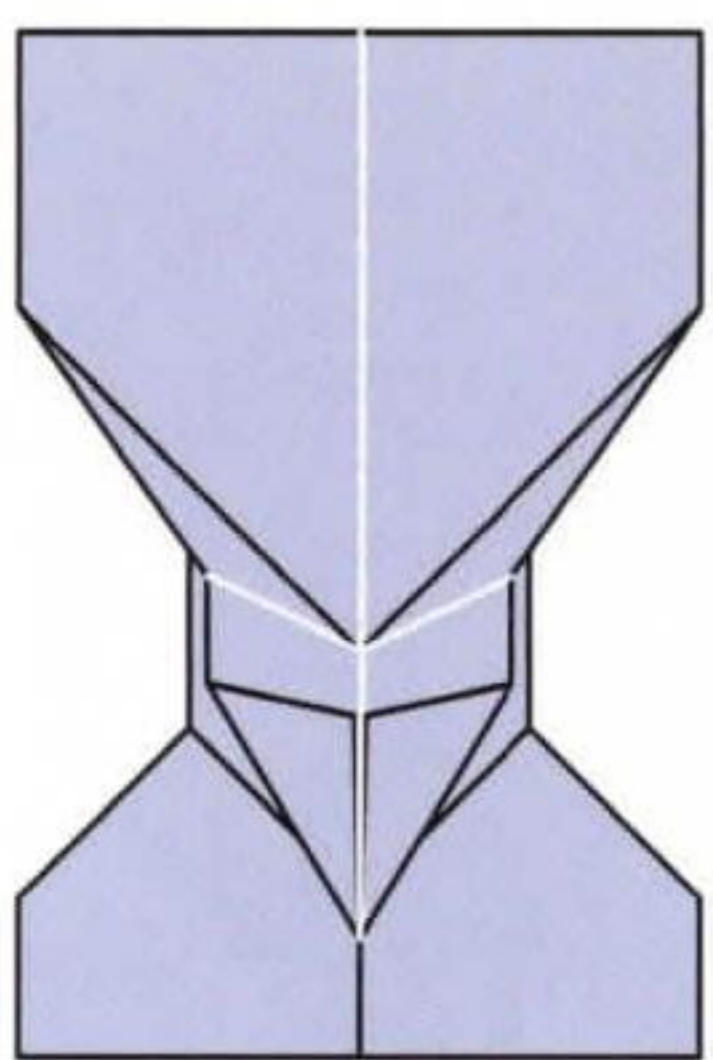

16. Before complete

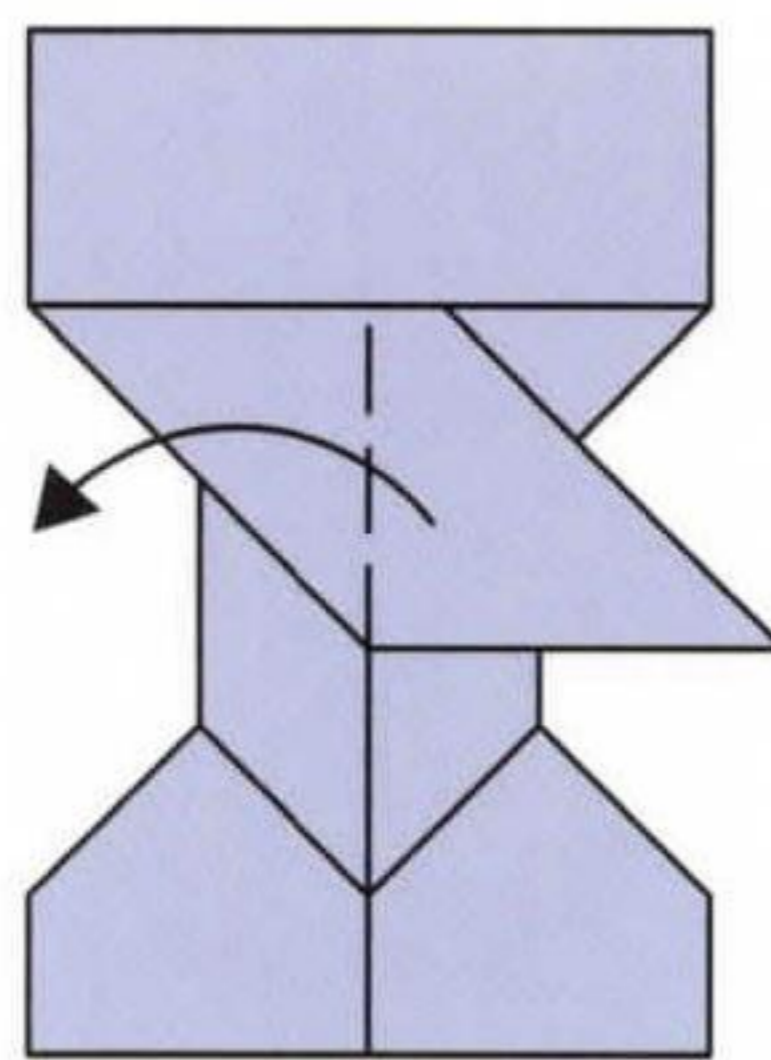

17. Valley fold

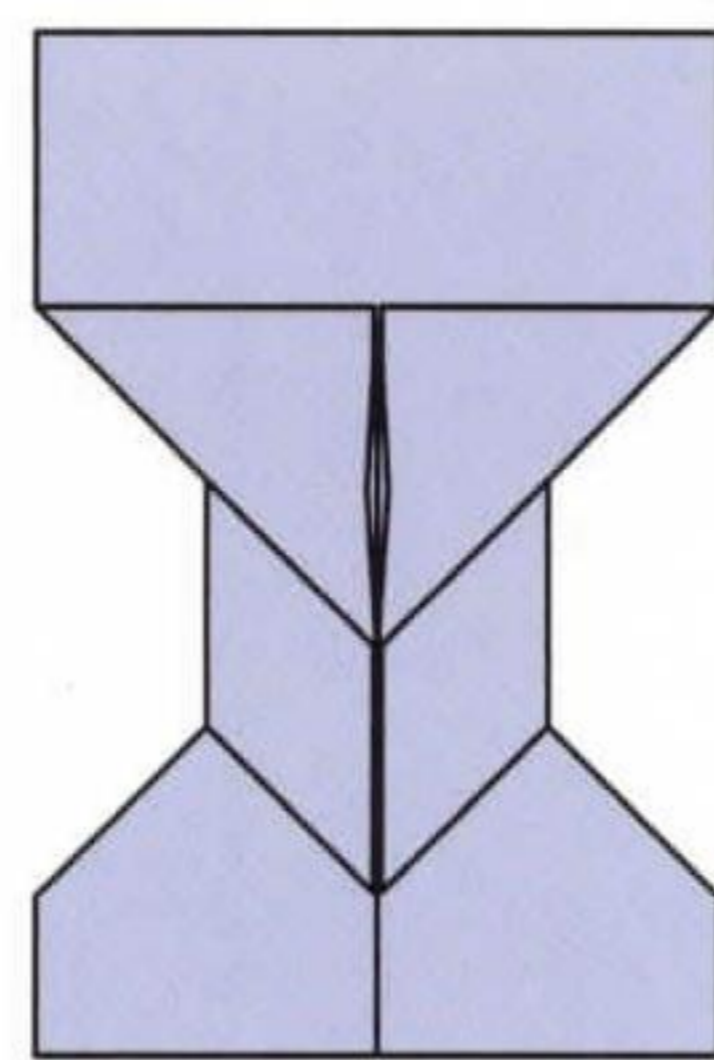

18. Rotate

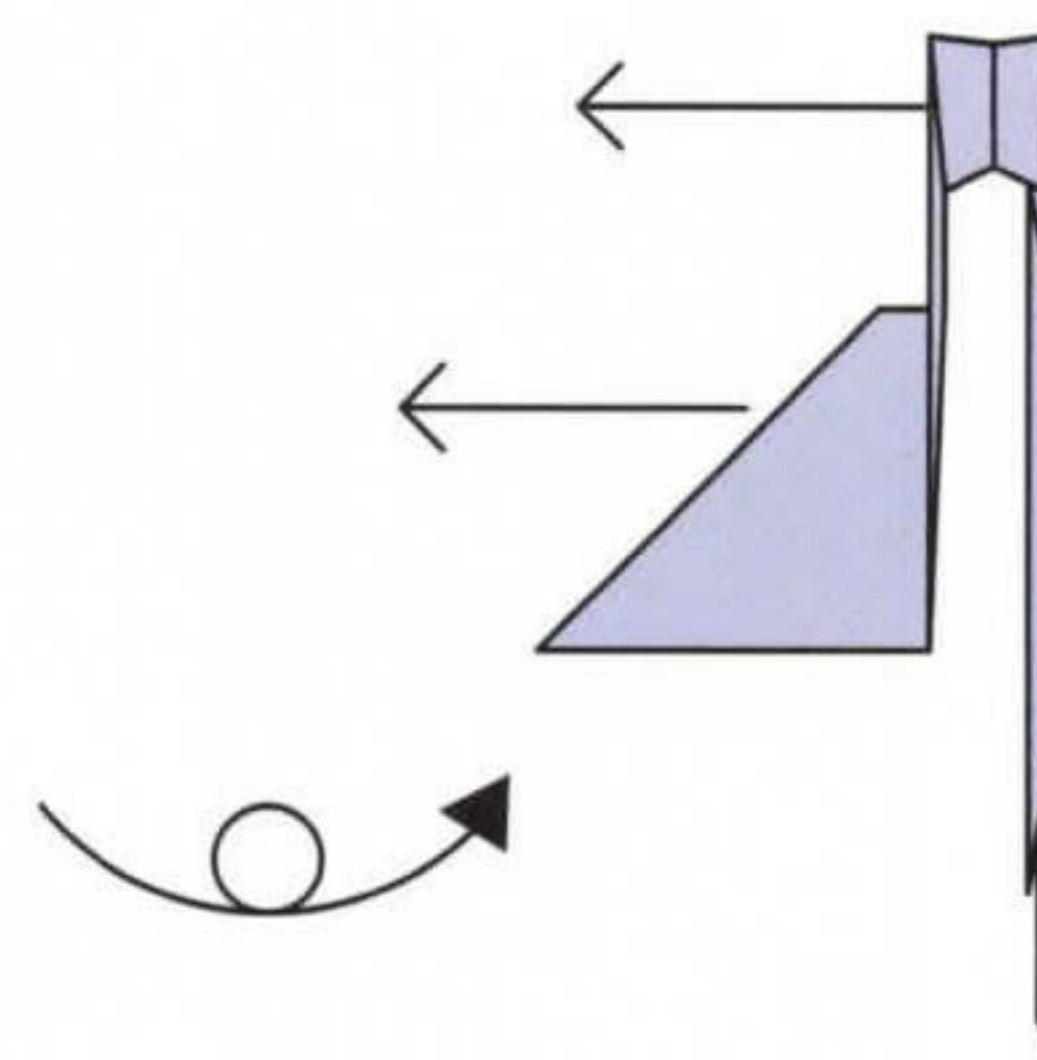

19. Pull and fold

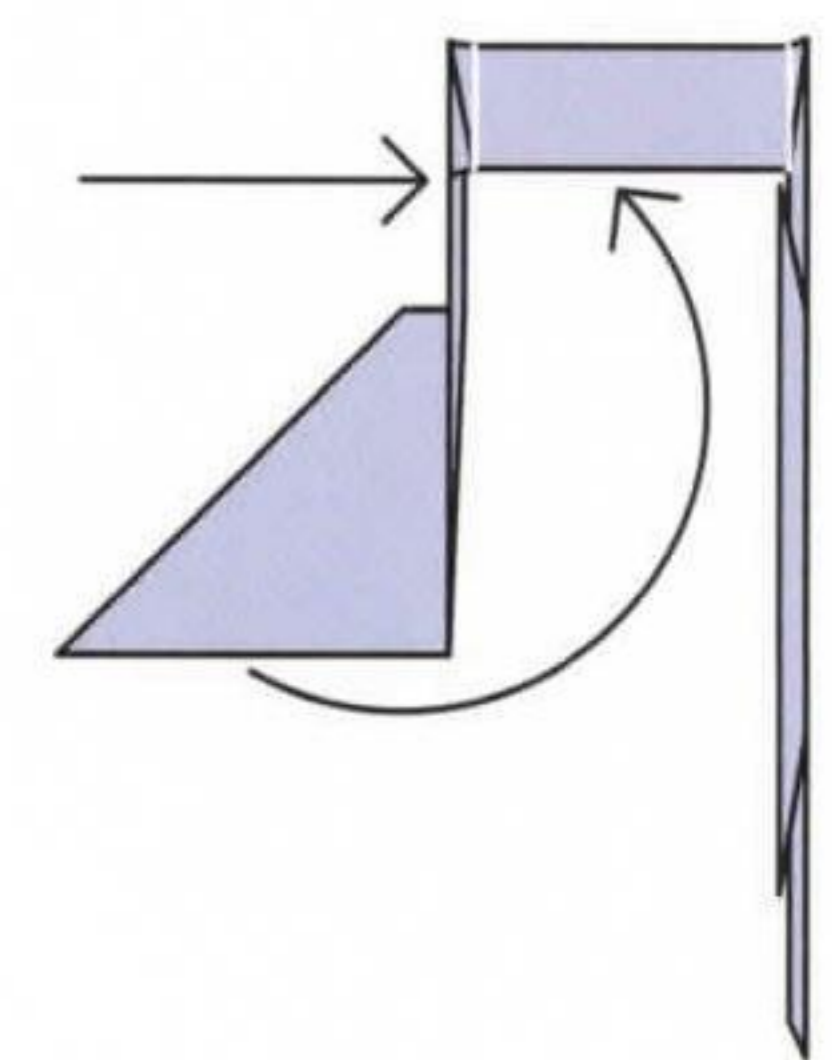

20. Bend and glue

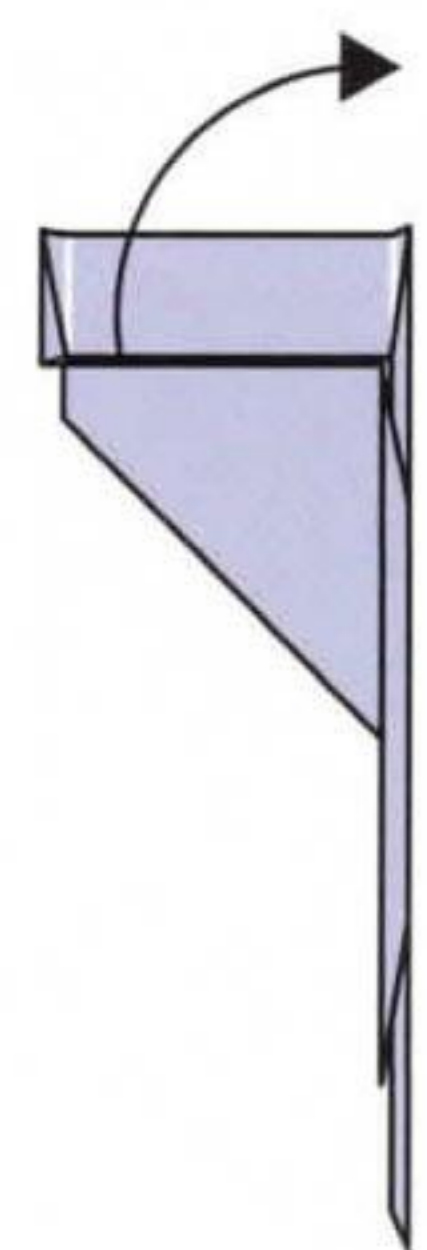

21. Valley folds

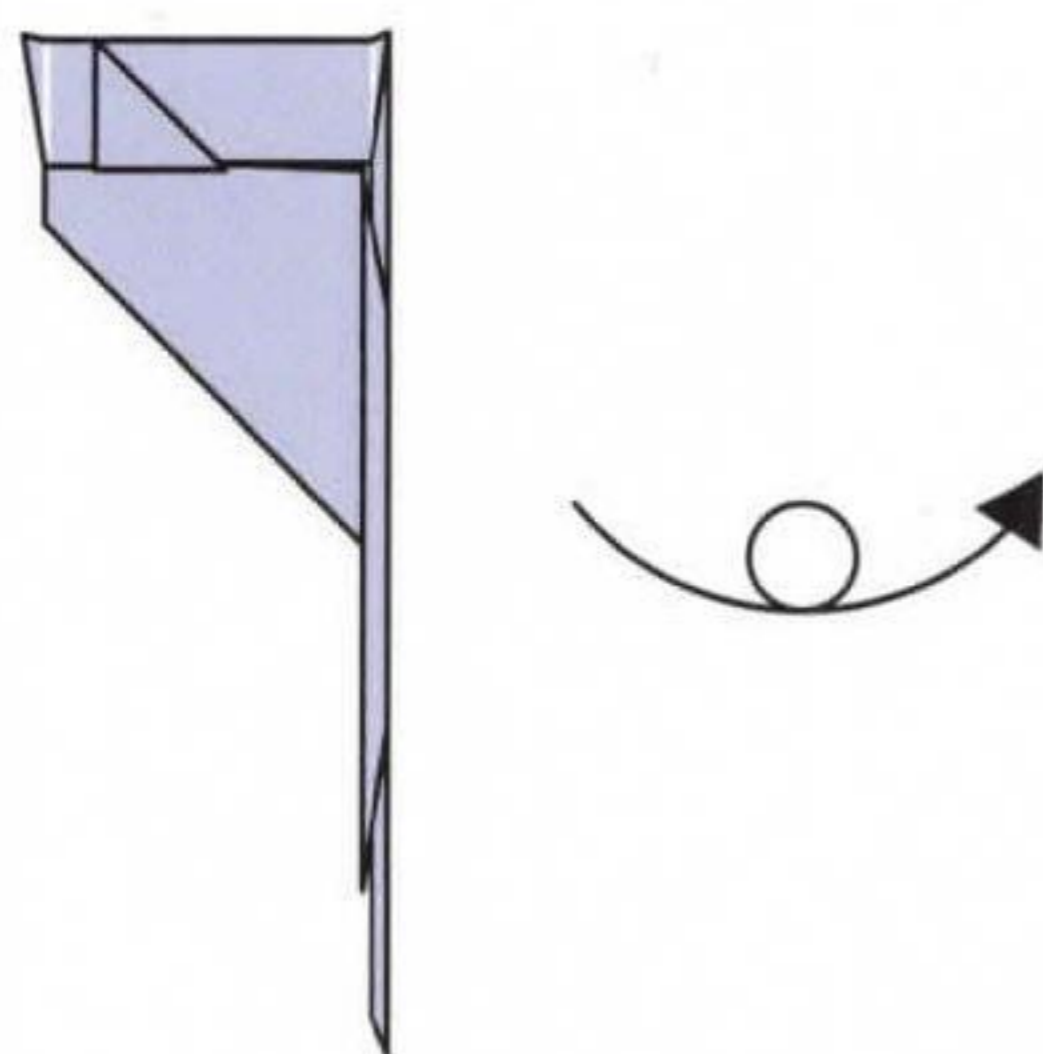

22. Rotate

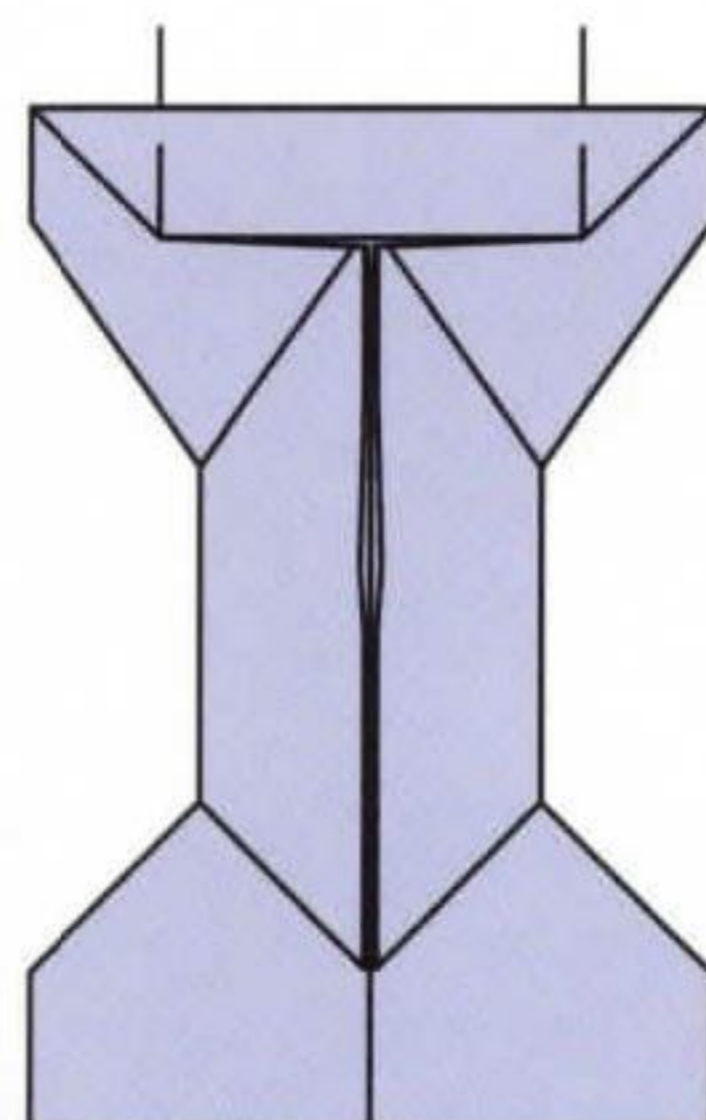

23. Valley folds

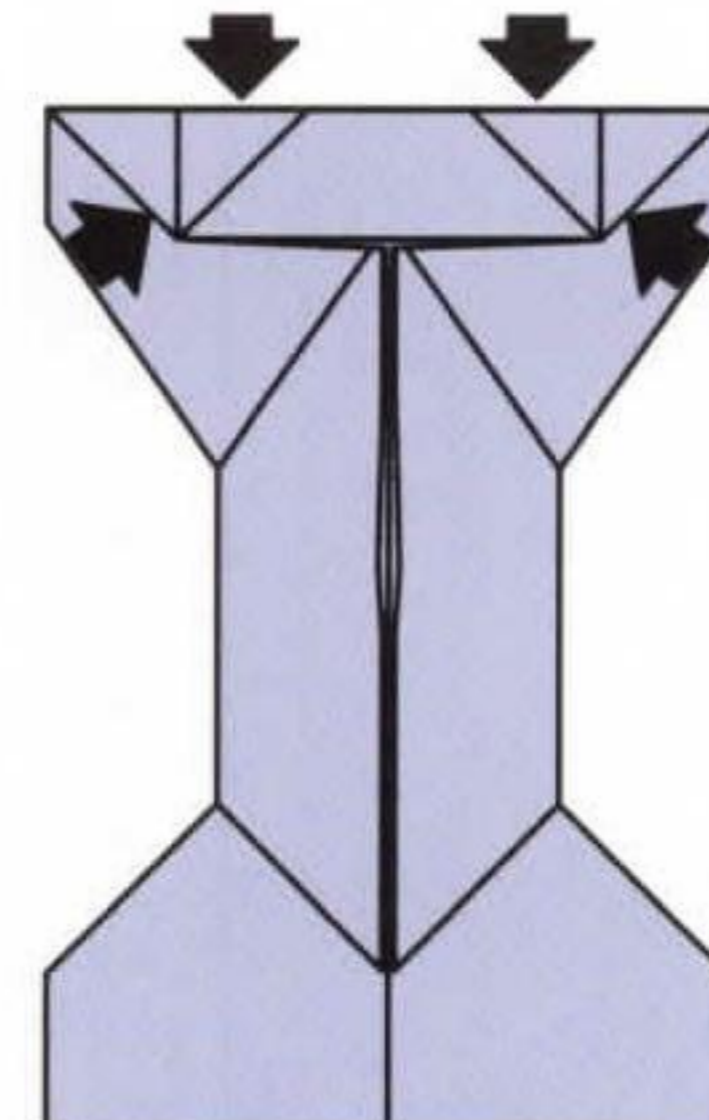

24. Add glue

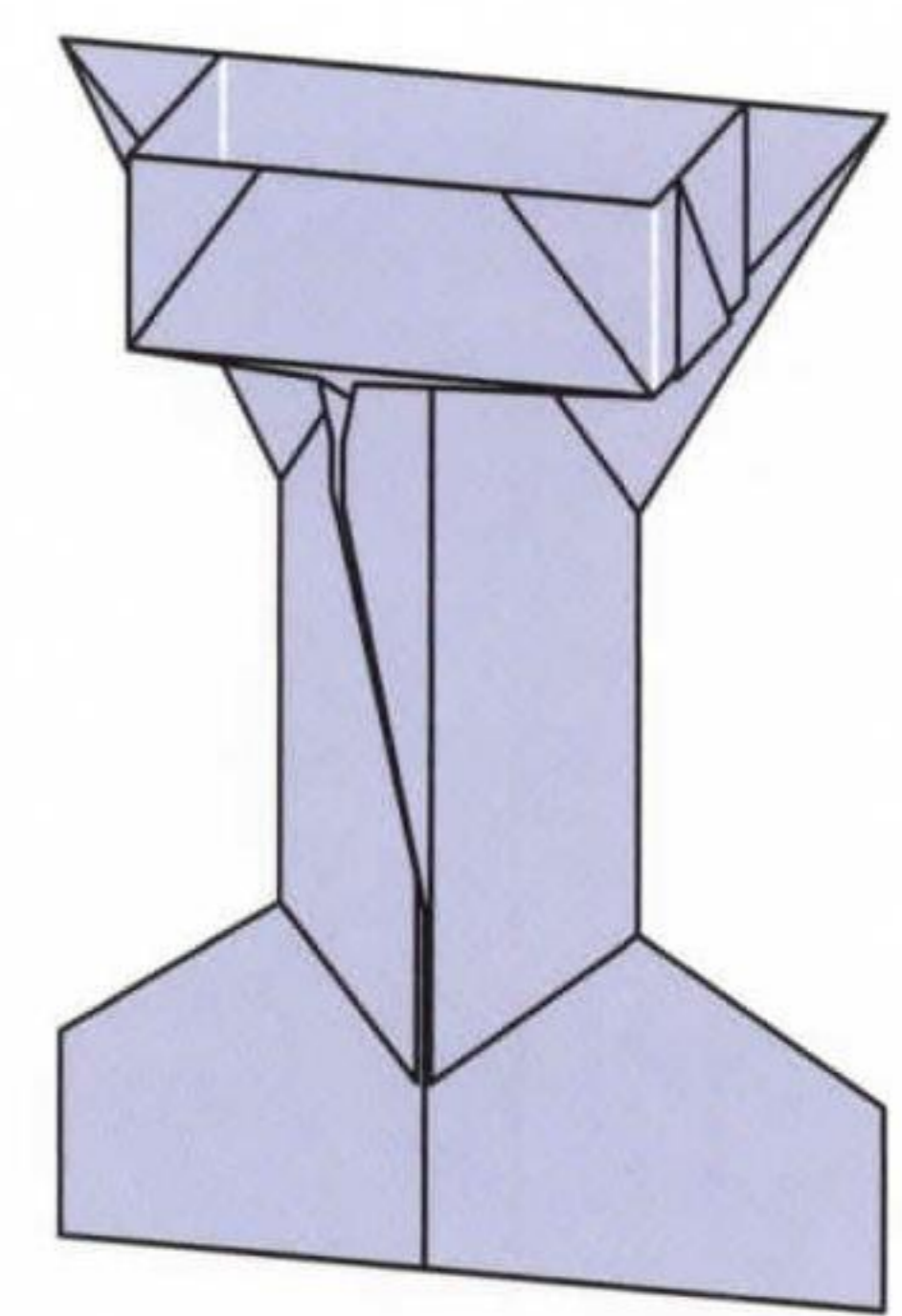

25. Completed SINK (BASIN)

► toilet: part 1

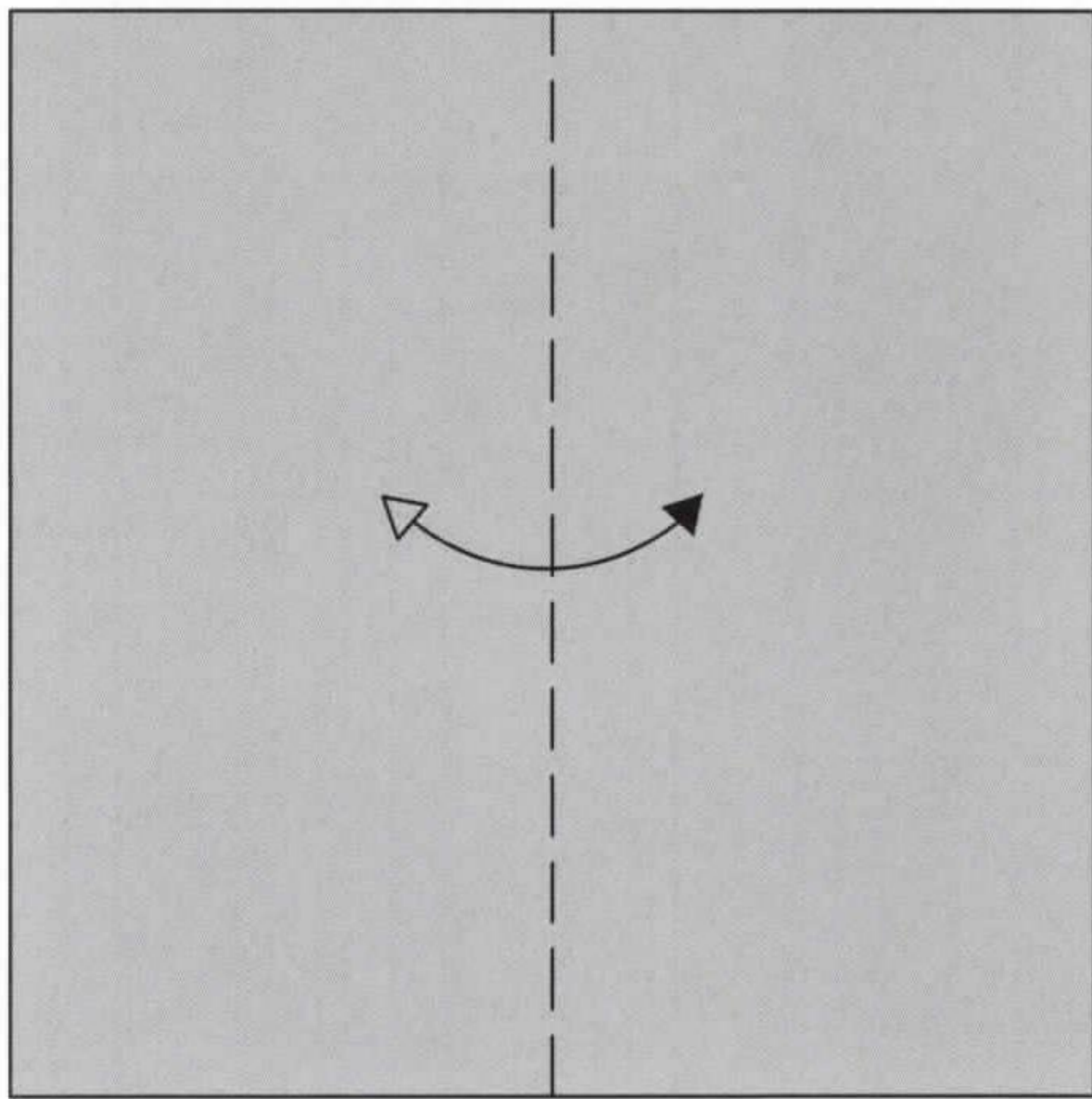

1. Valley fold and unfold

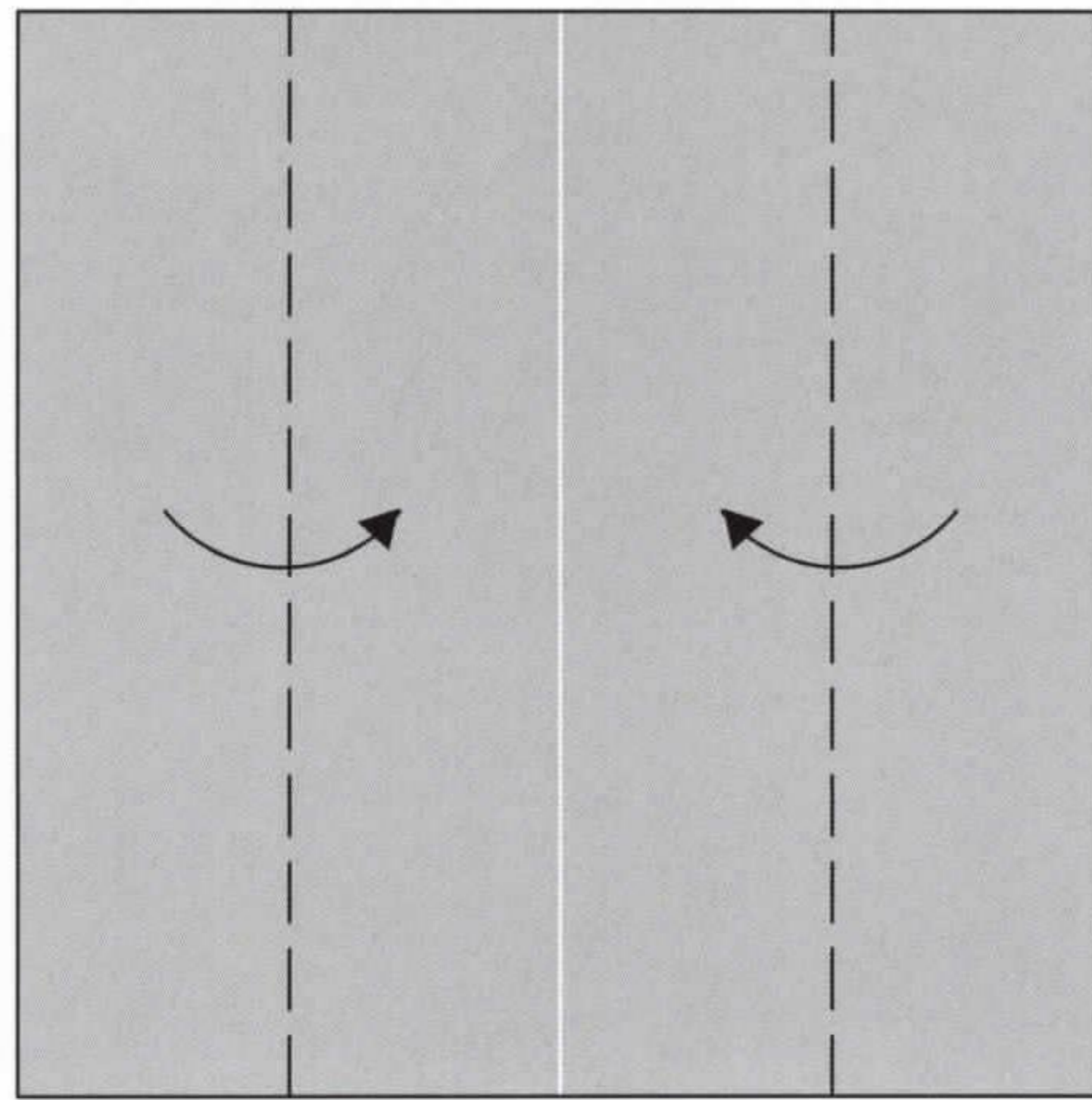

2. Valley folds

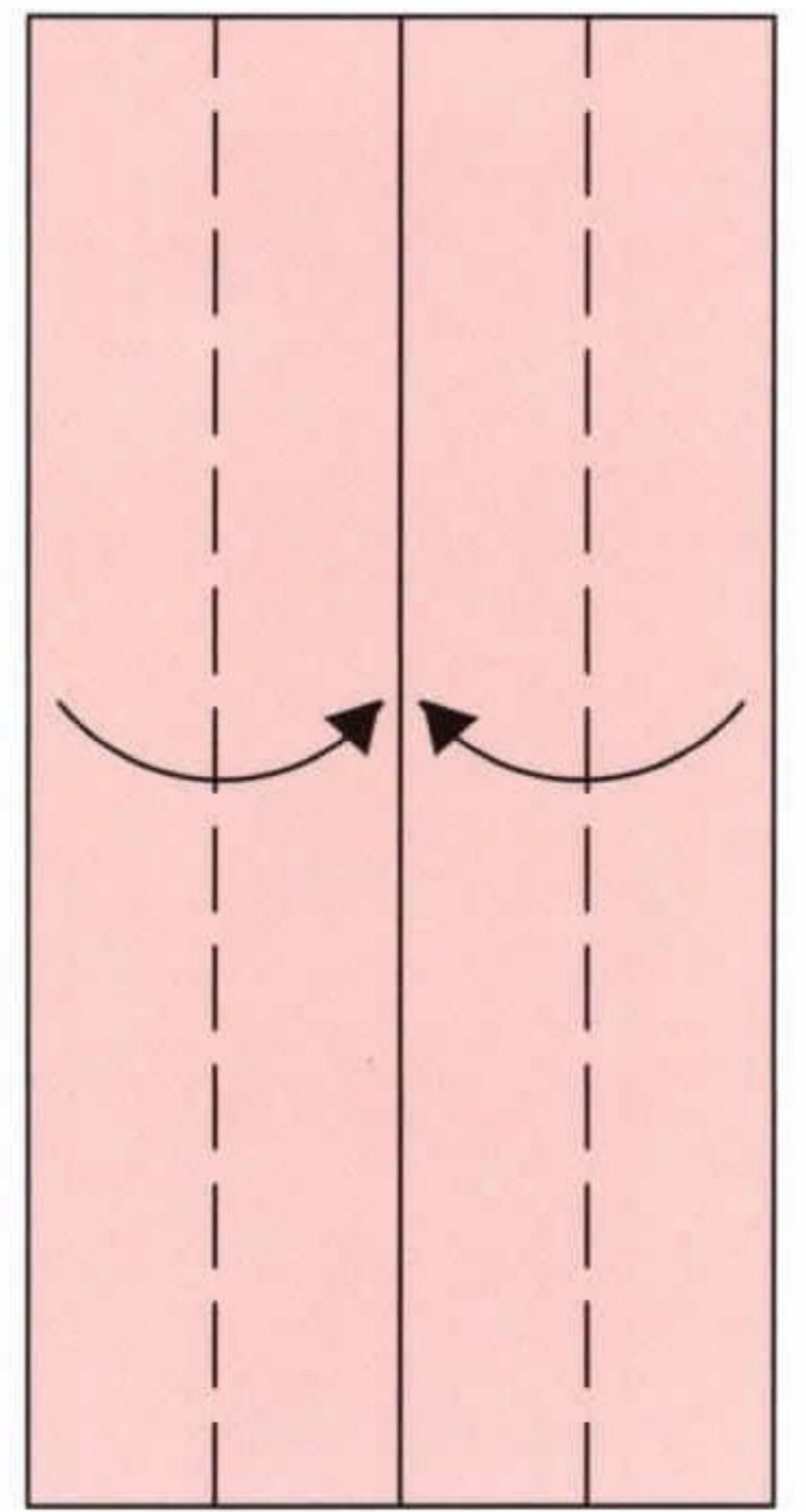

3. Valley folds

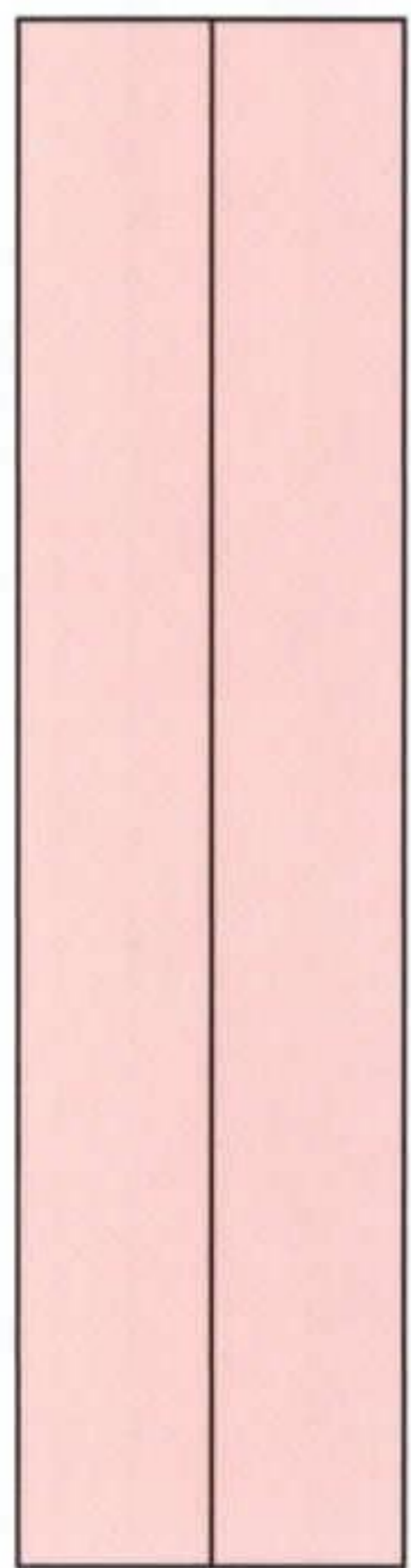

4. Scale-up

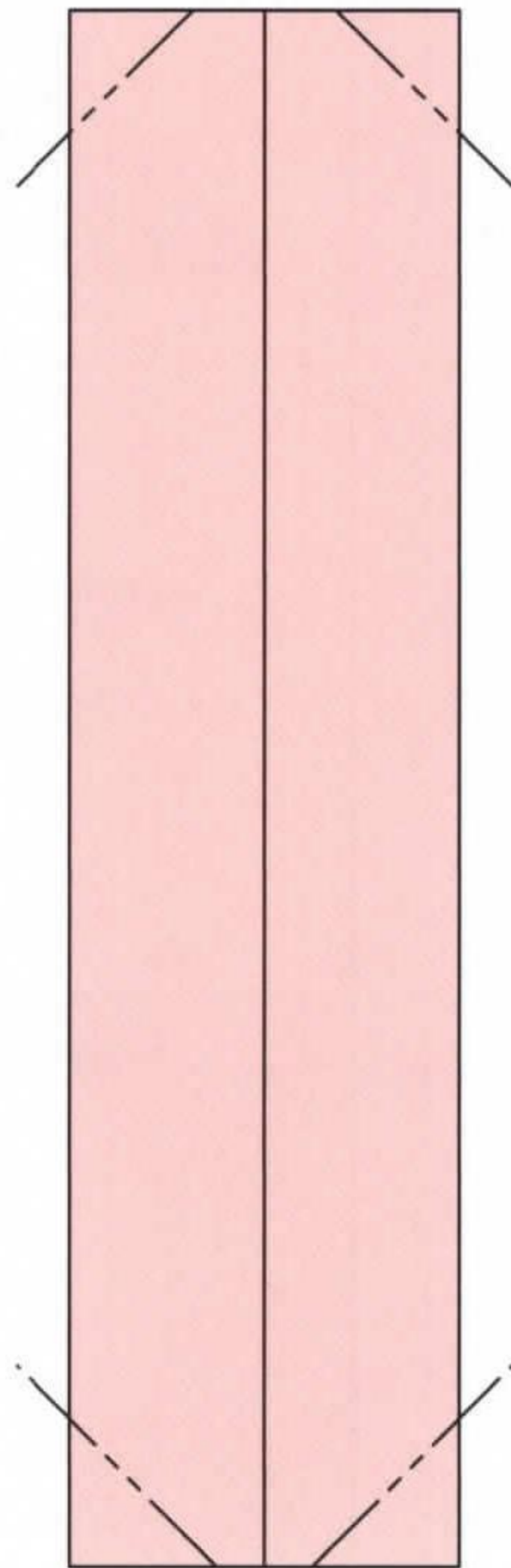

5. Inside reverse folds

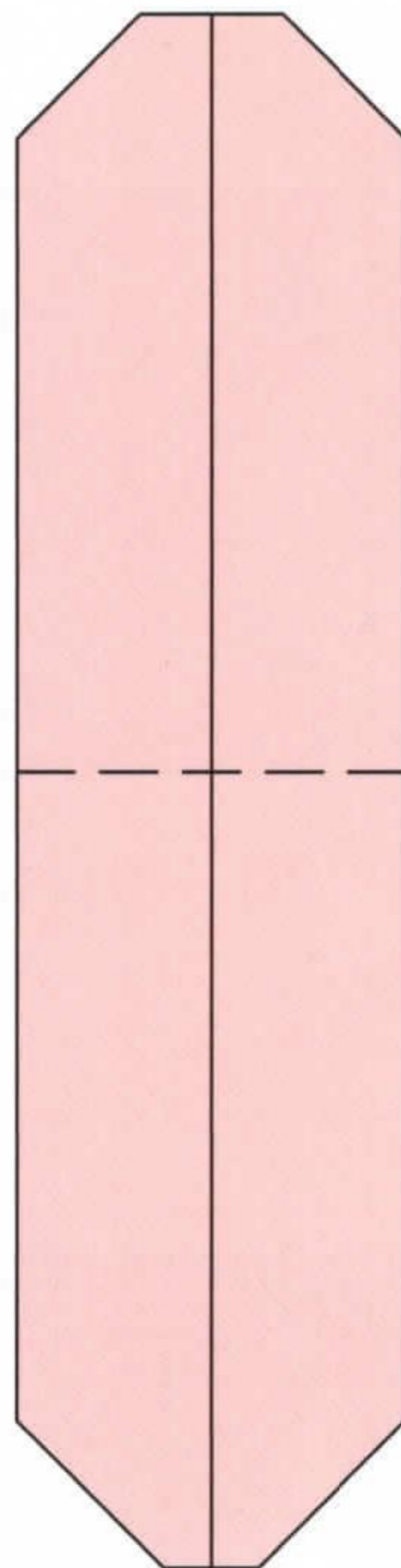

6. Valley fold

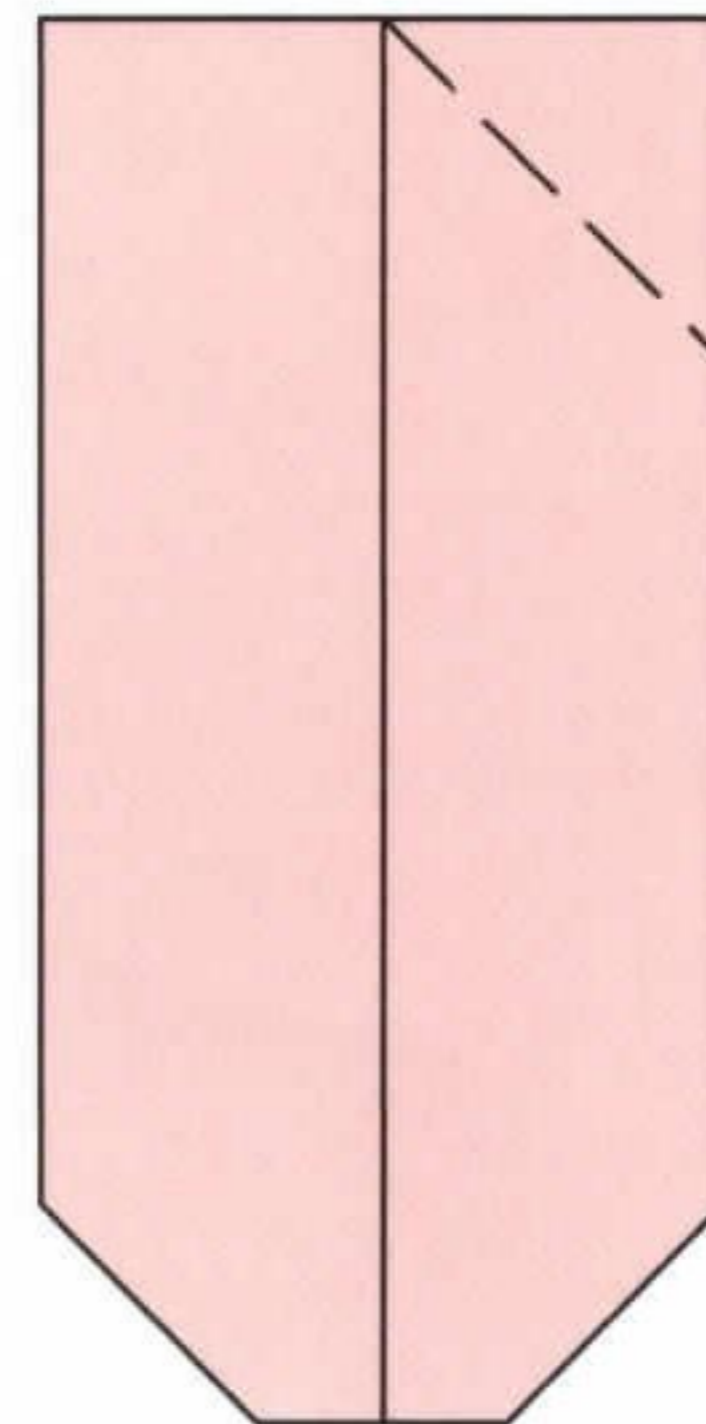

7. Valley folds and unfold

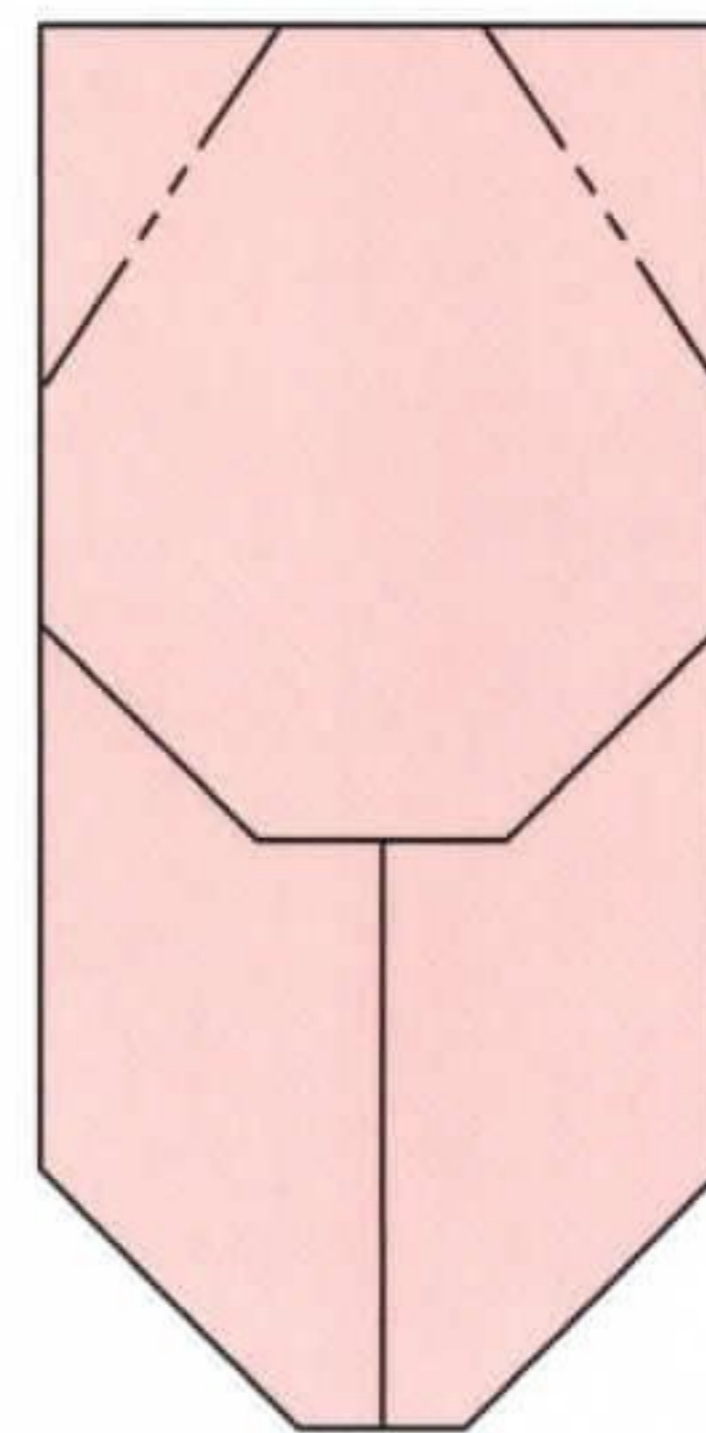

9. Inside reverse folds

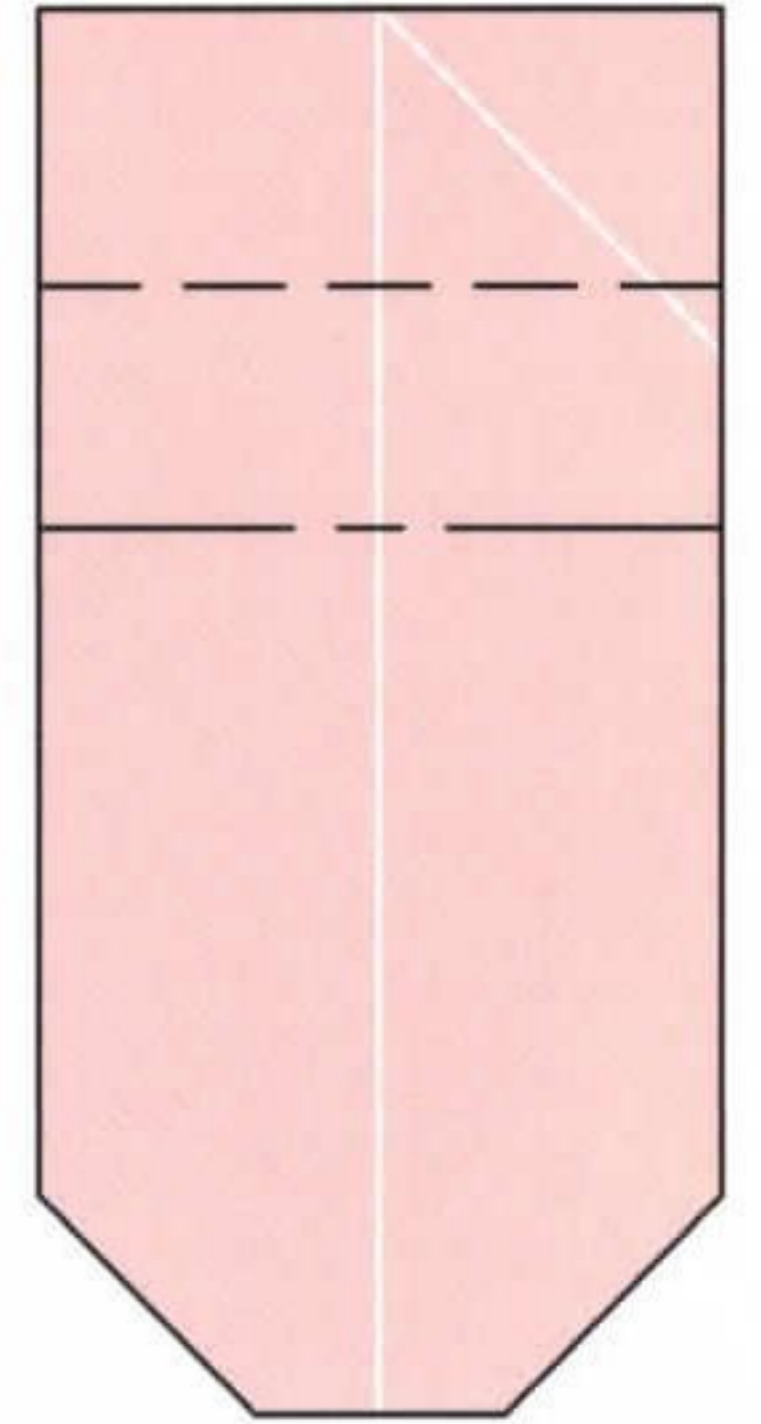

8. Pleat fold

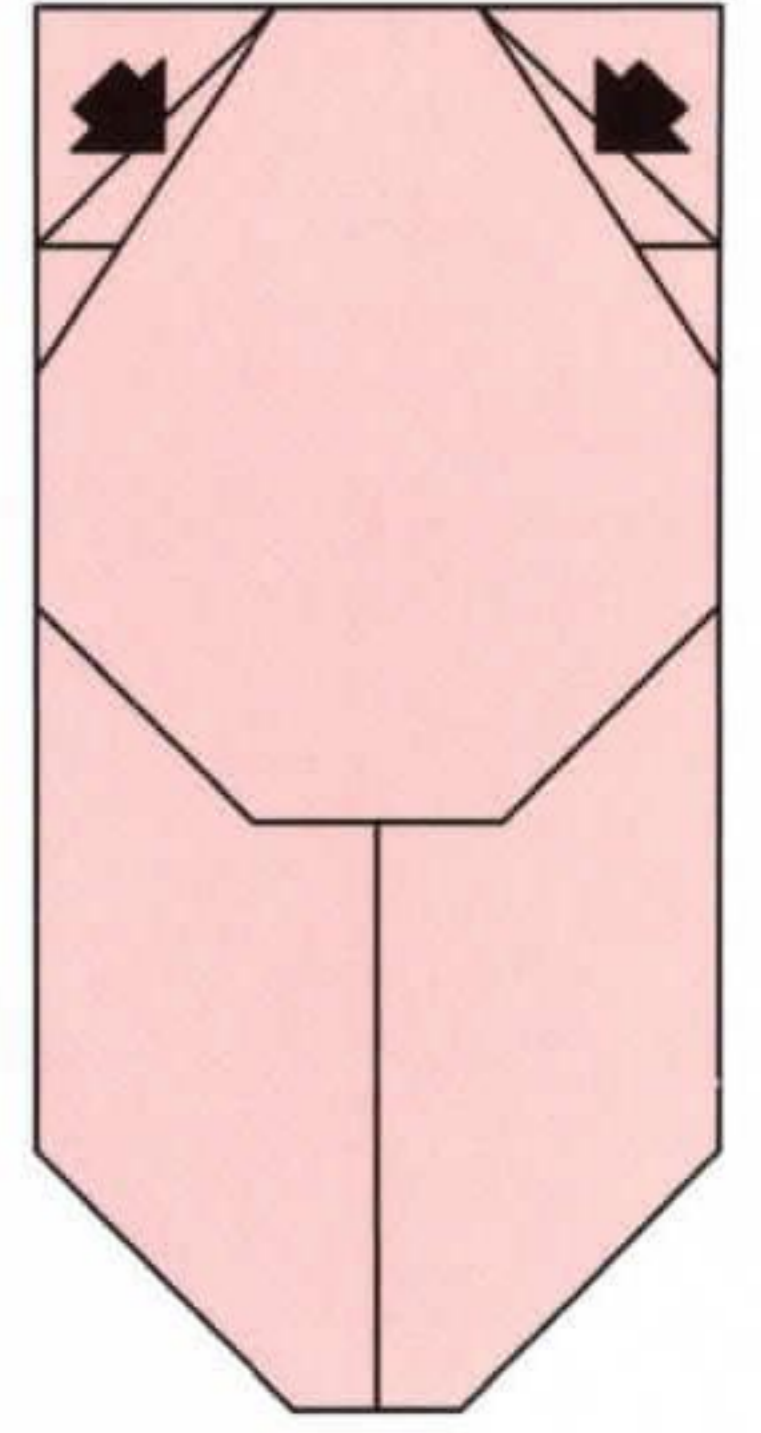

10. Add glue

toilet: part 1

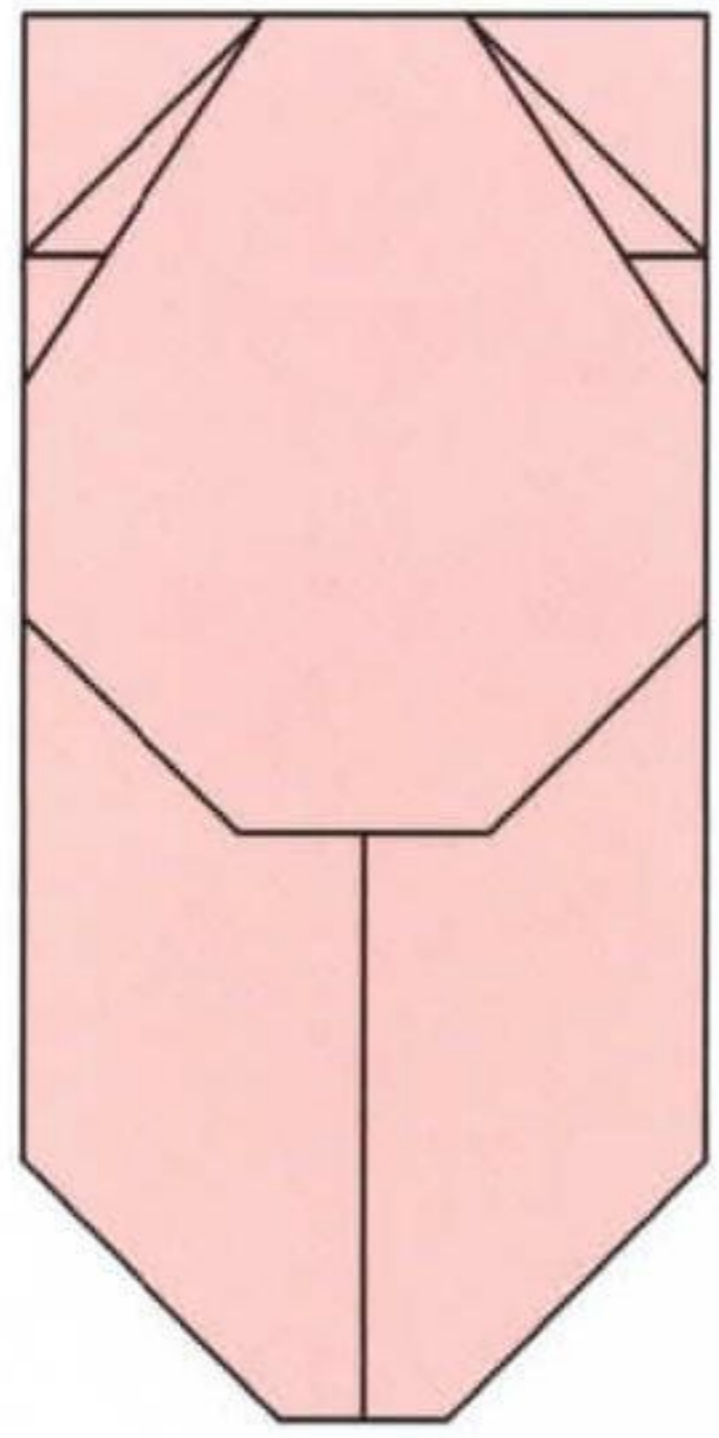

11. Turn over and rotate

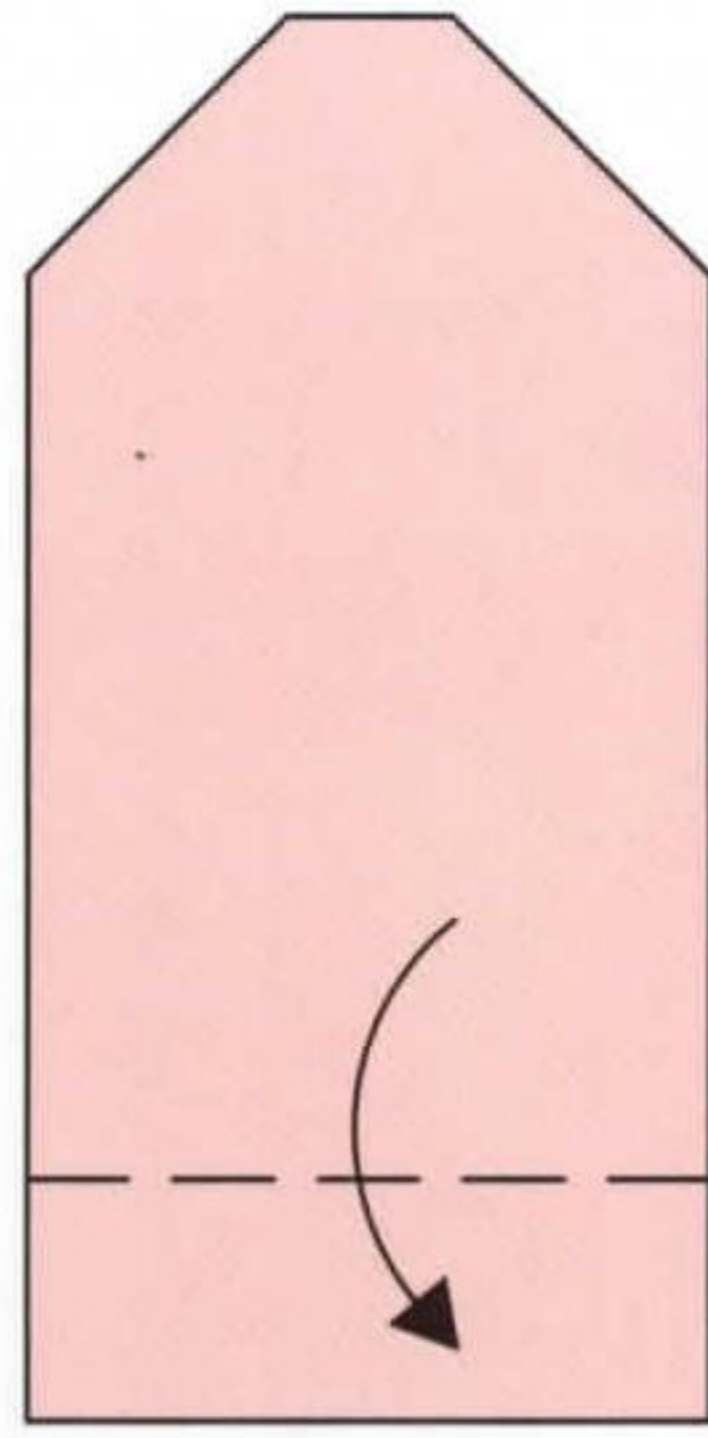

12. Valley fold

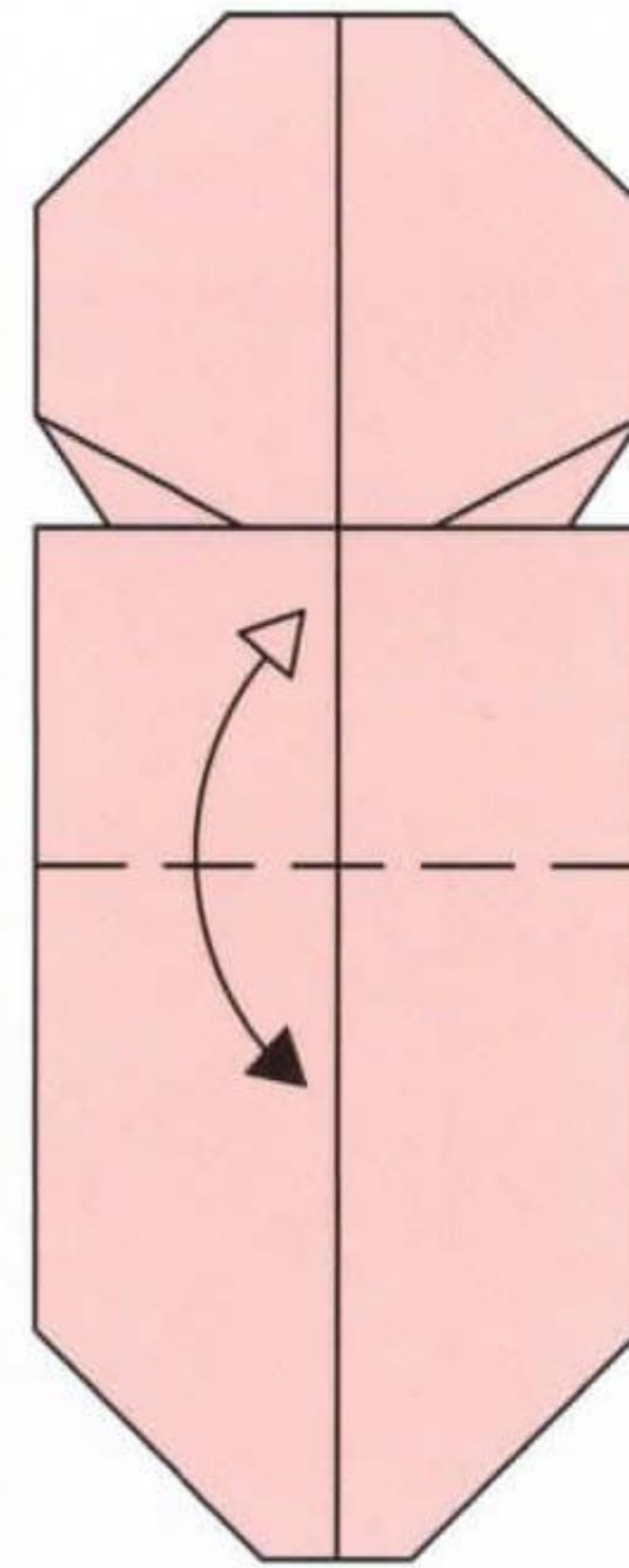

13. Valley fold and unfold

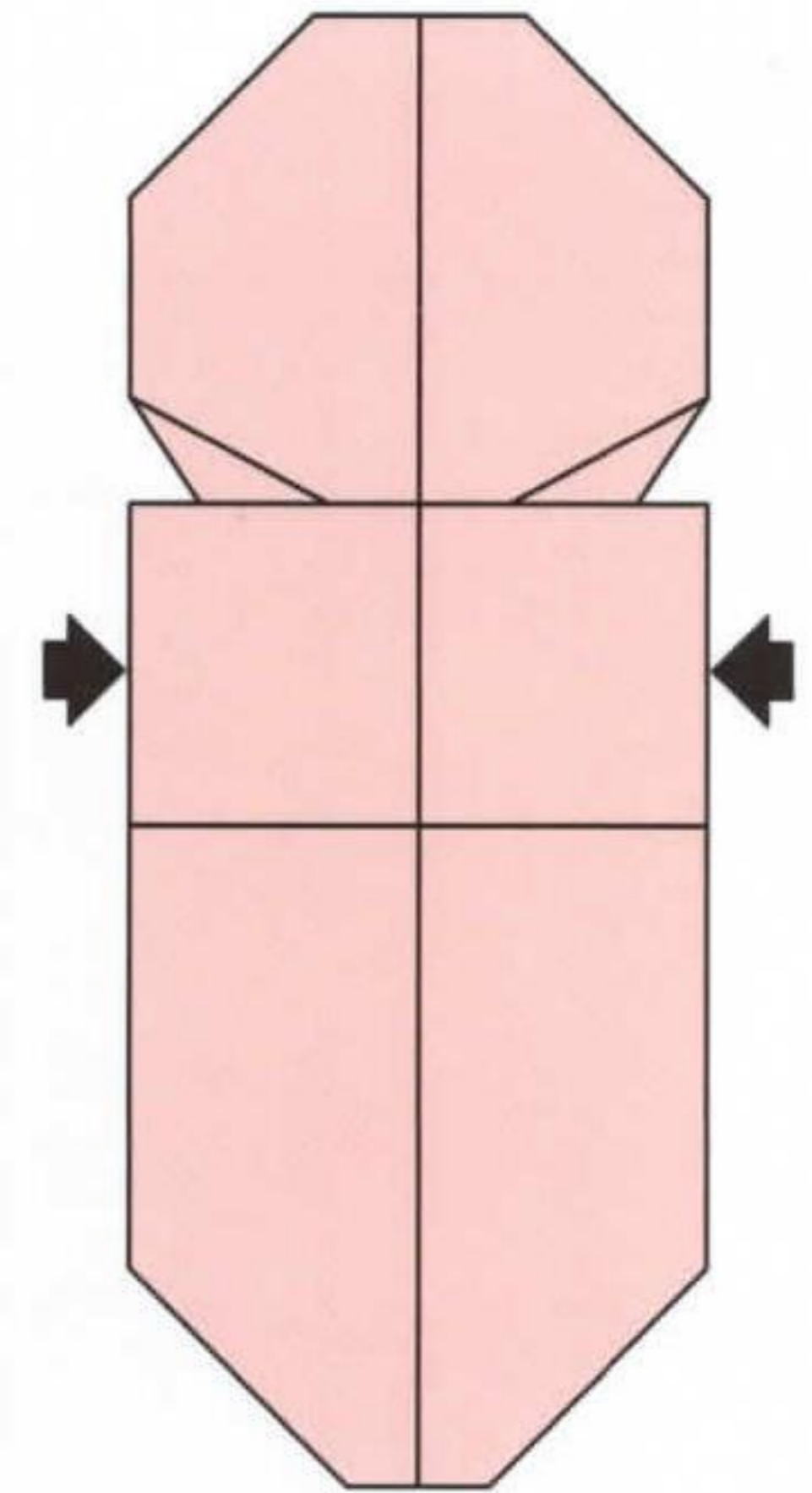

14. Add glue

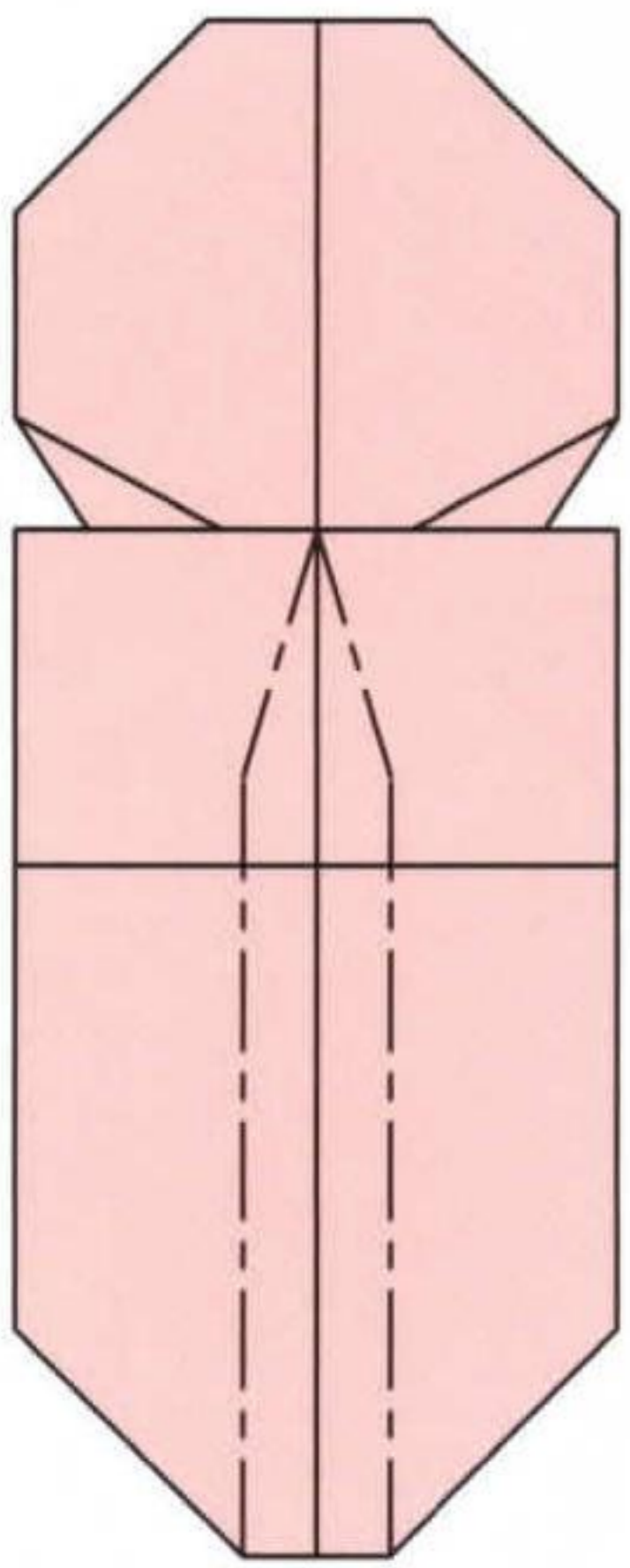

15. Add creases

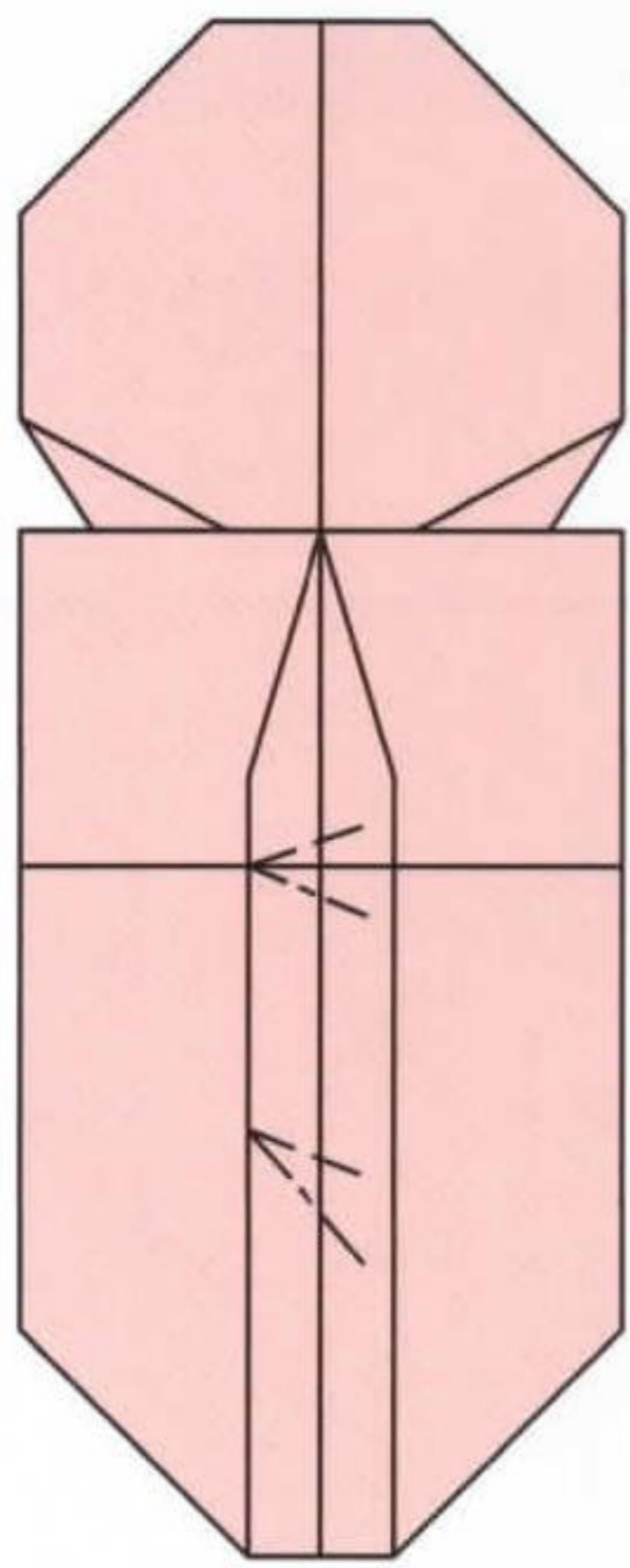

16. Pleat and unpleat

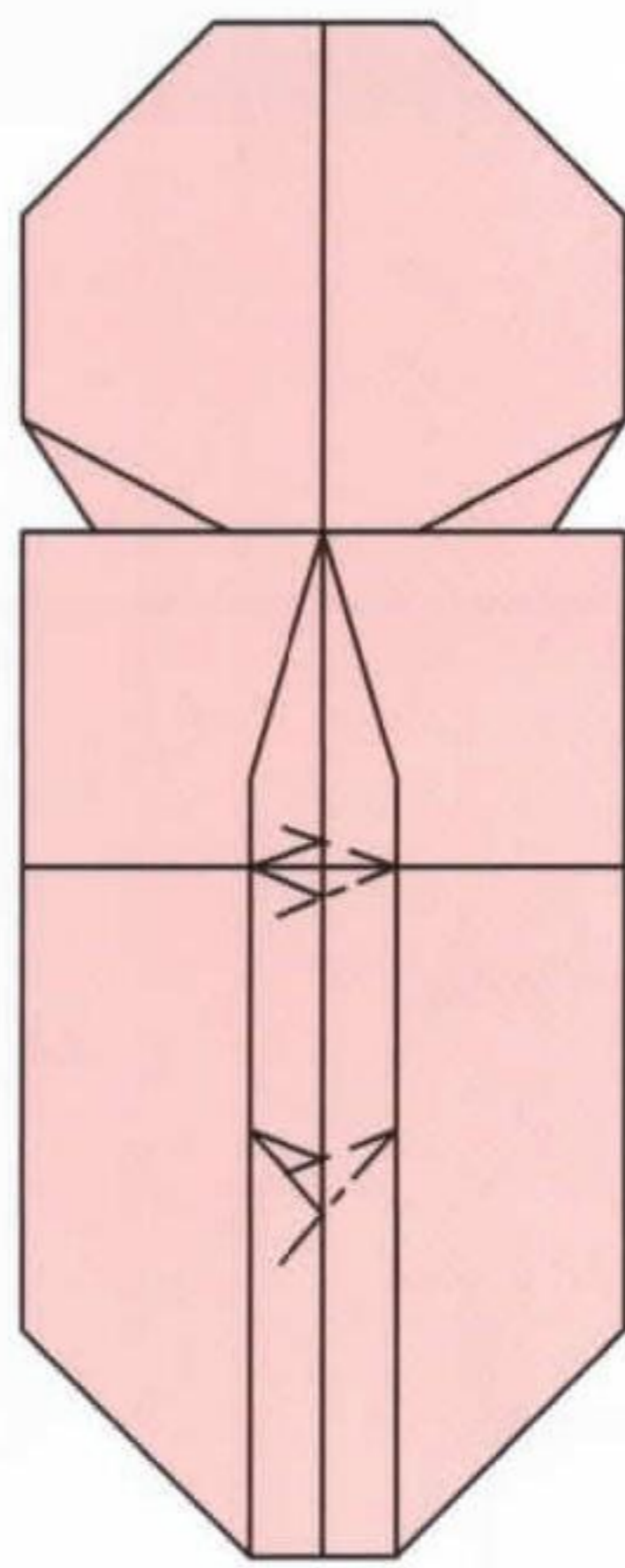

17. Repeat

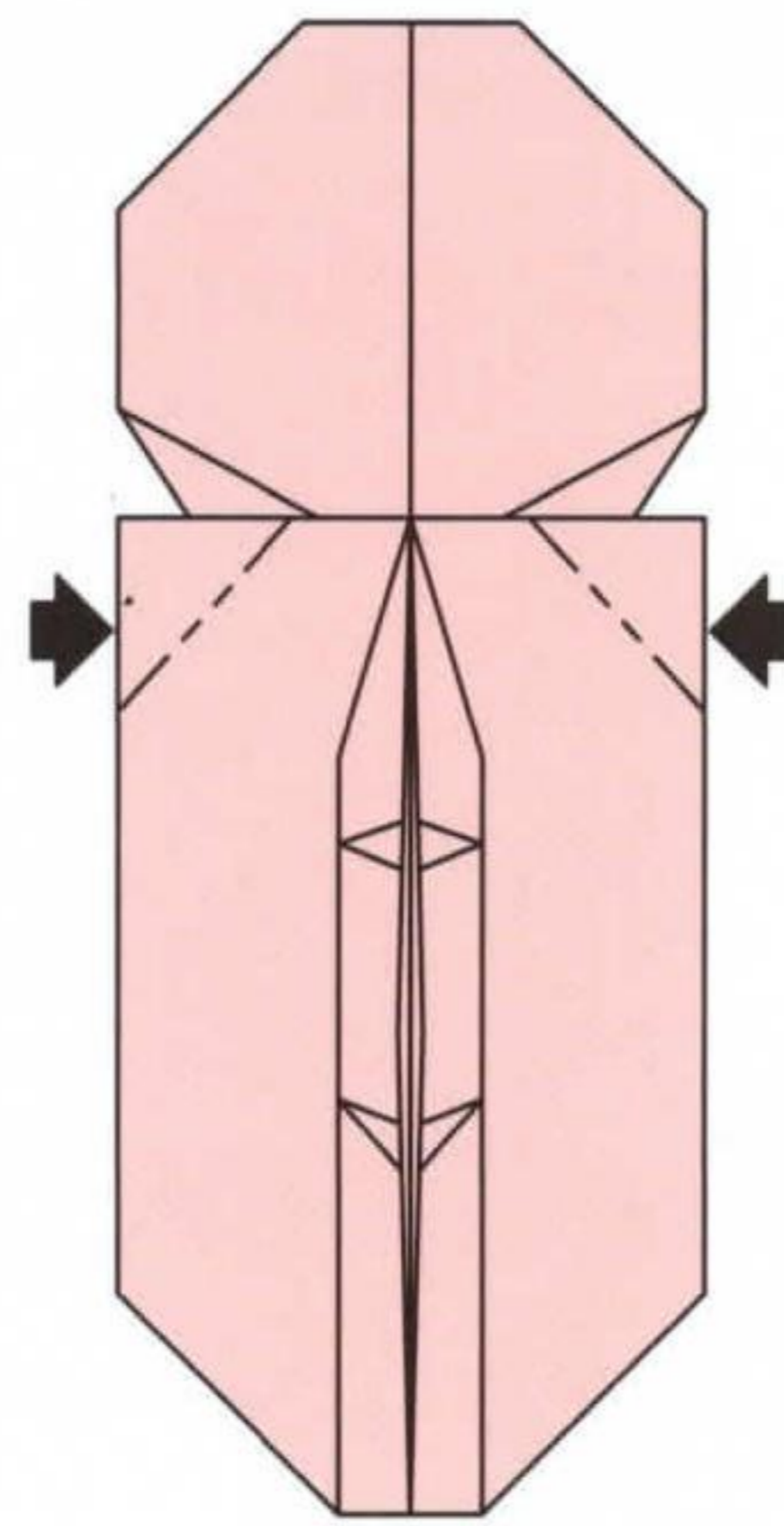

18. Inside reverse folds and apply glue

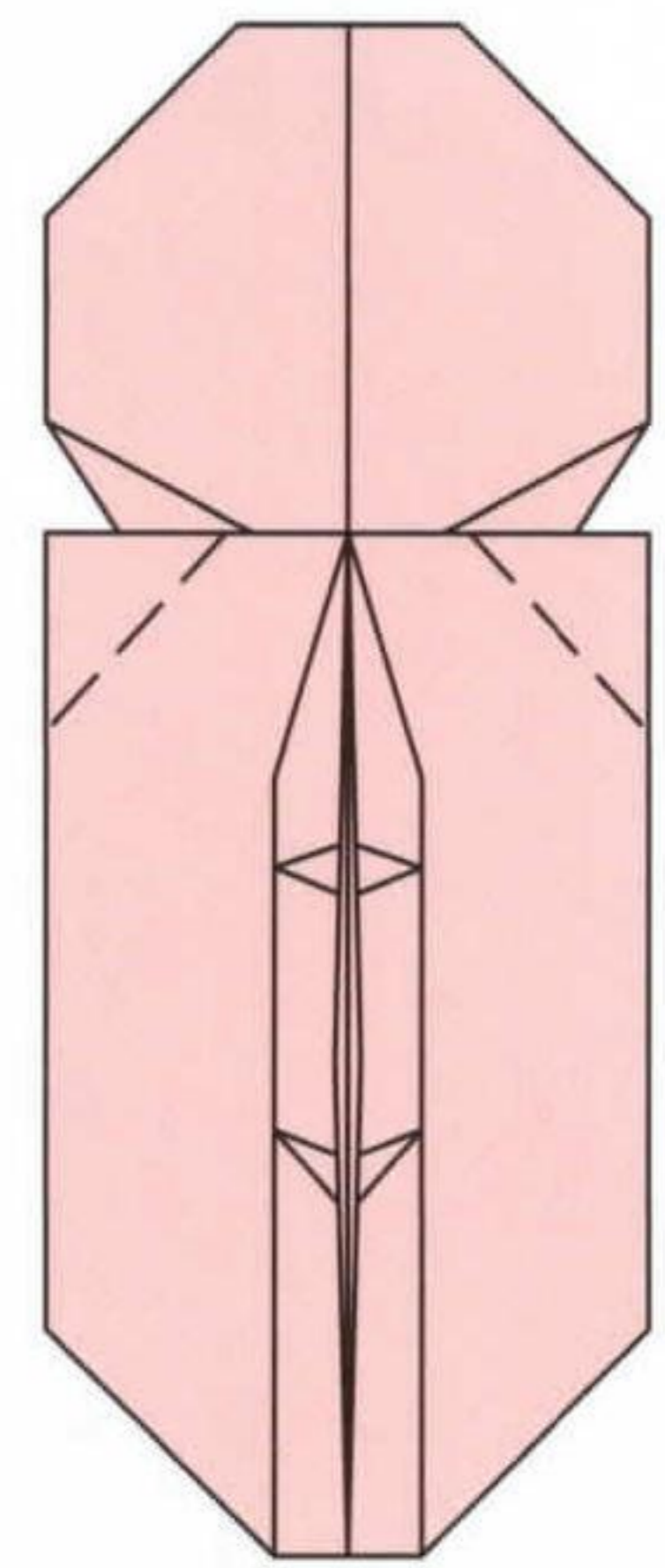

19. Valley fold and tuck-in

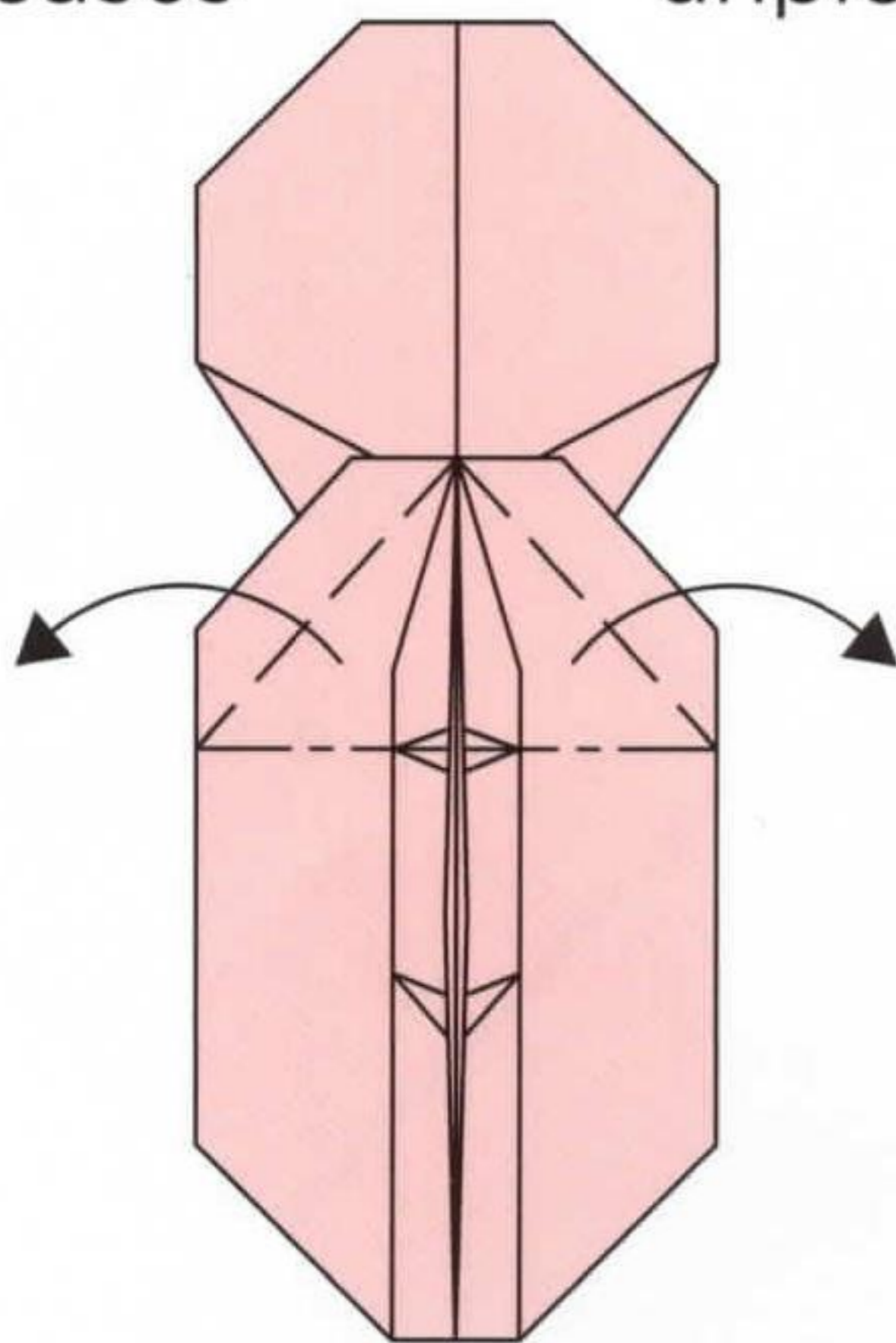

20. Squash folds

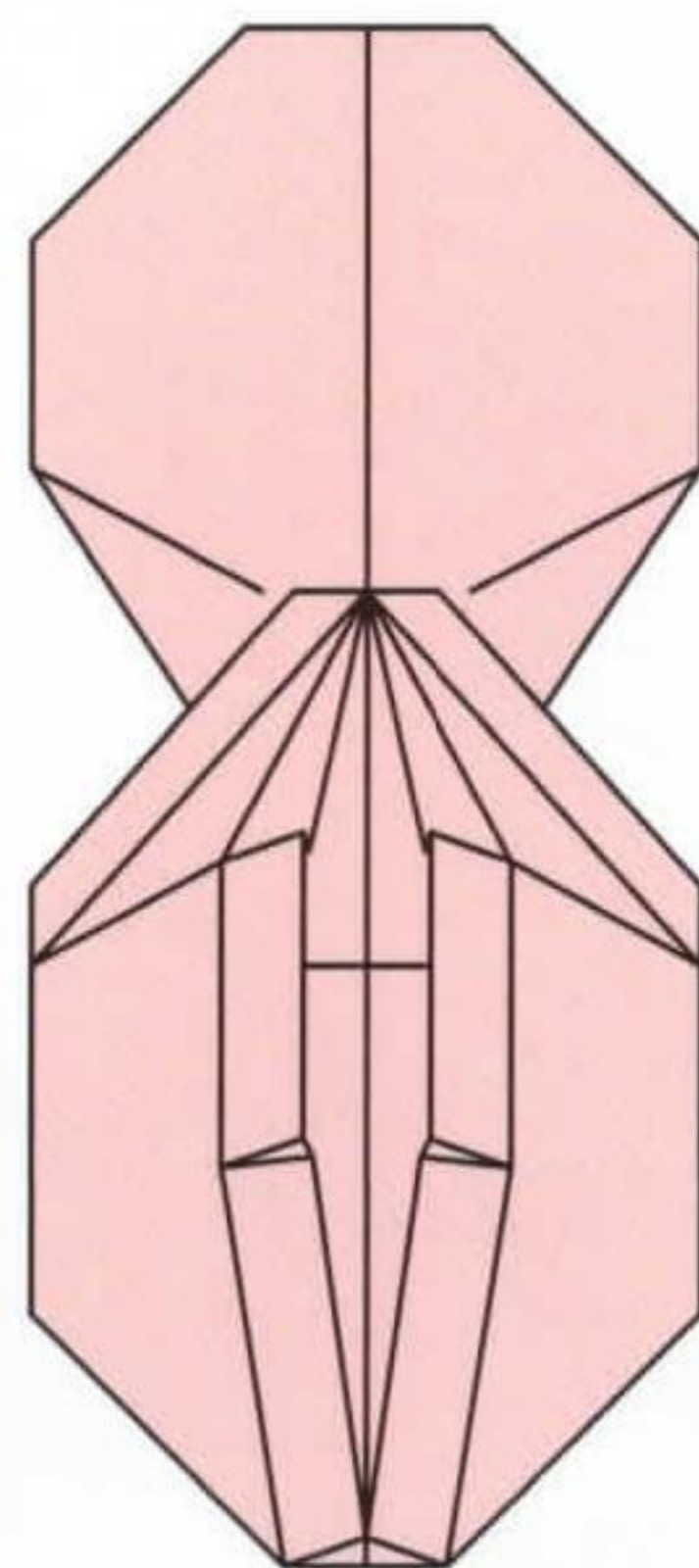

21. Before complete

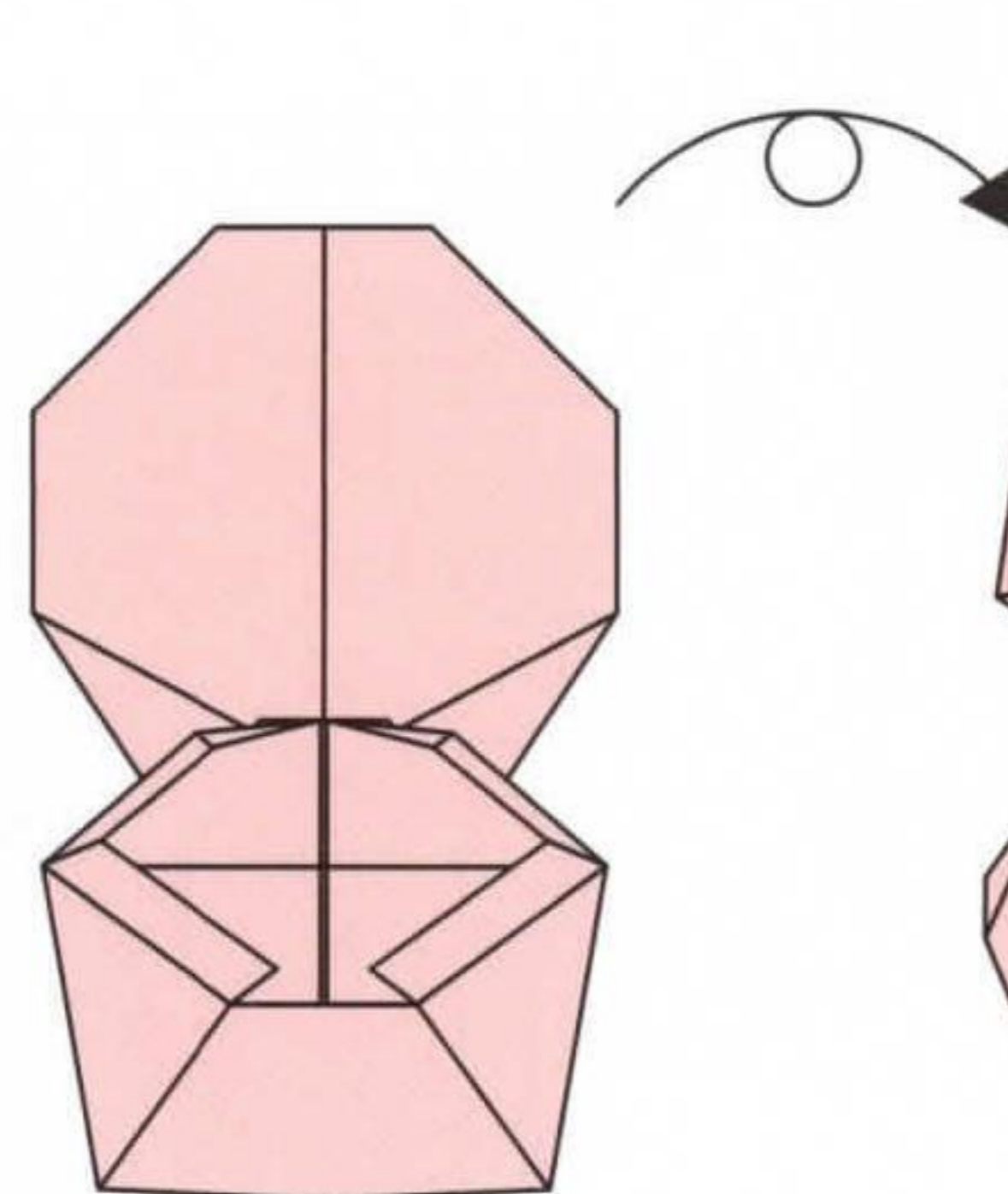

22. Rotate

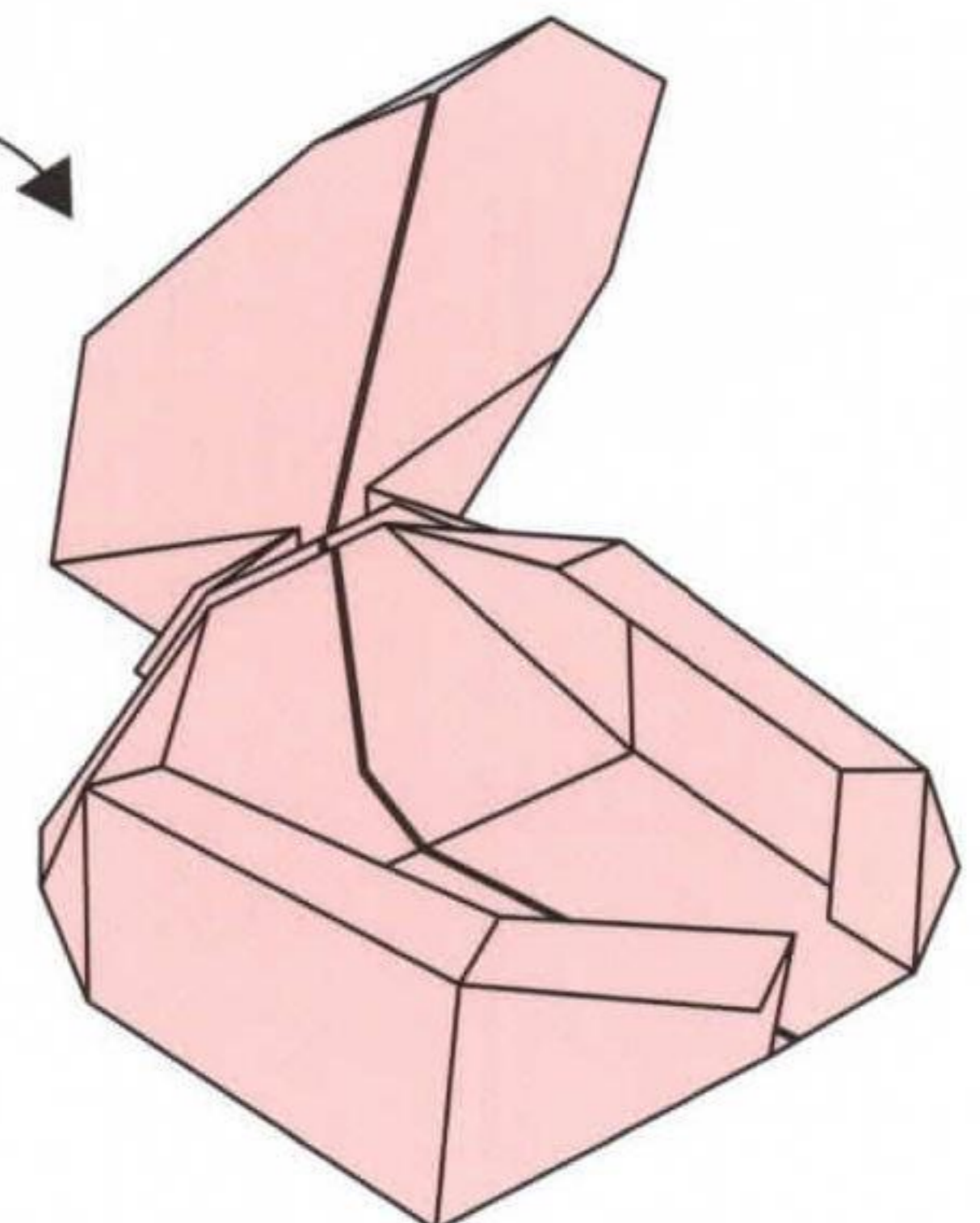

23. Completed PART 1

toilet: part 2

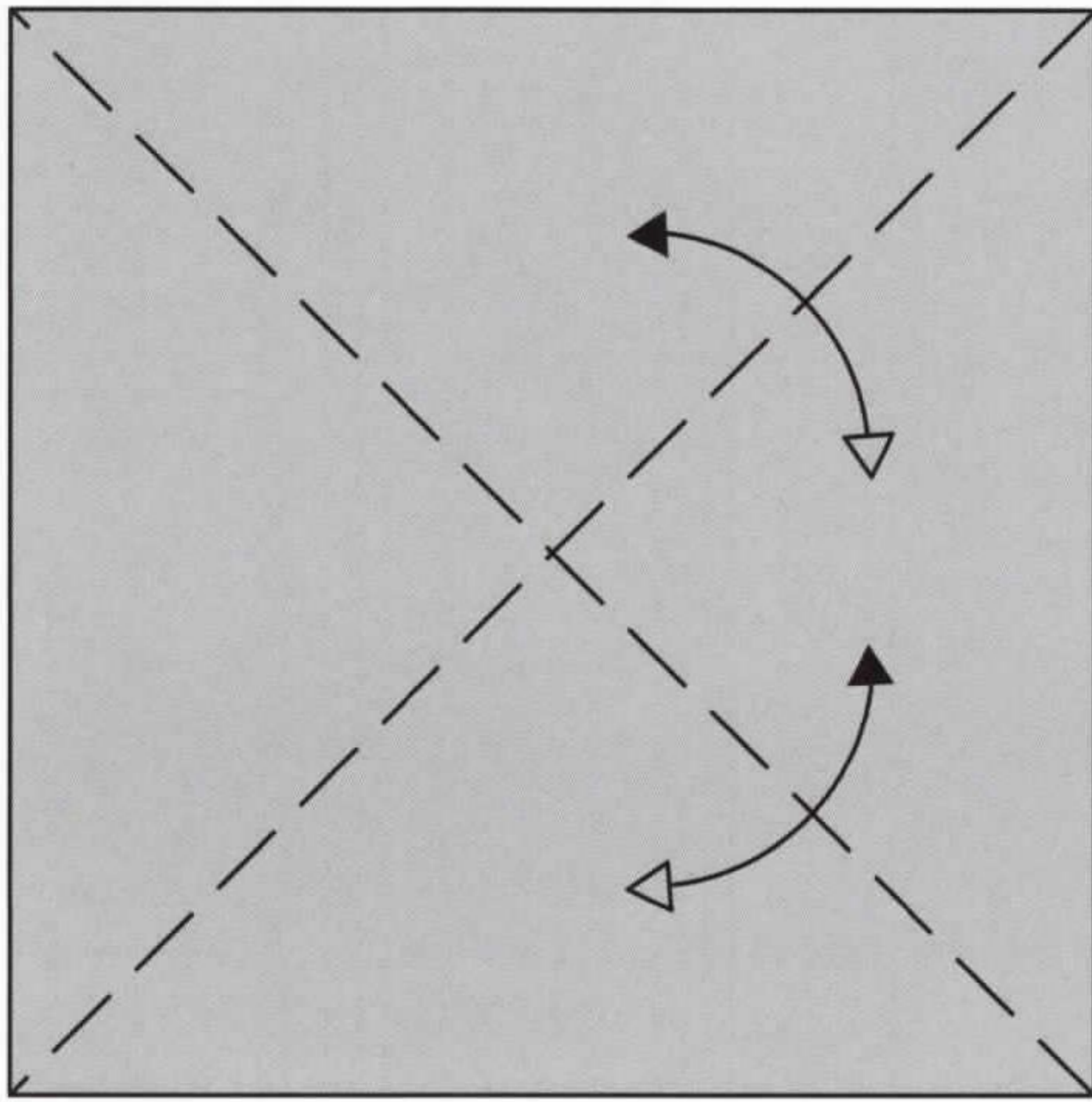

1. Valley fold and unfold

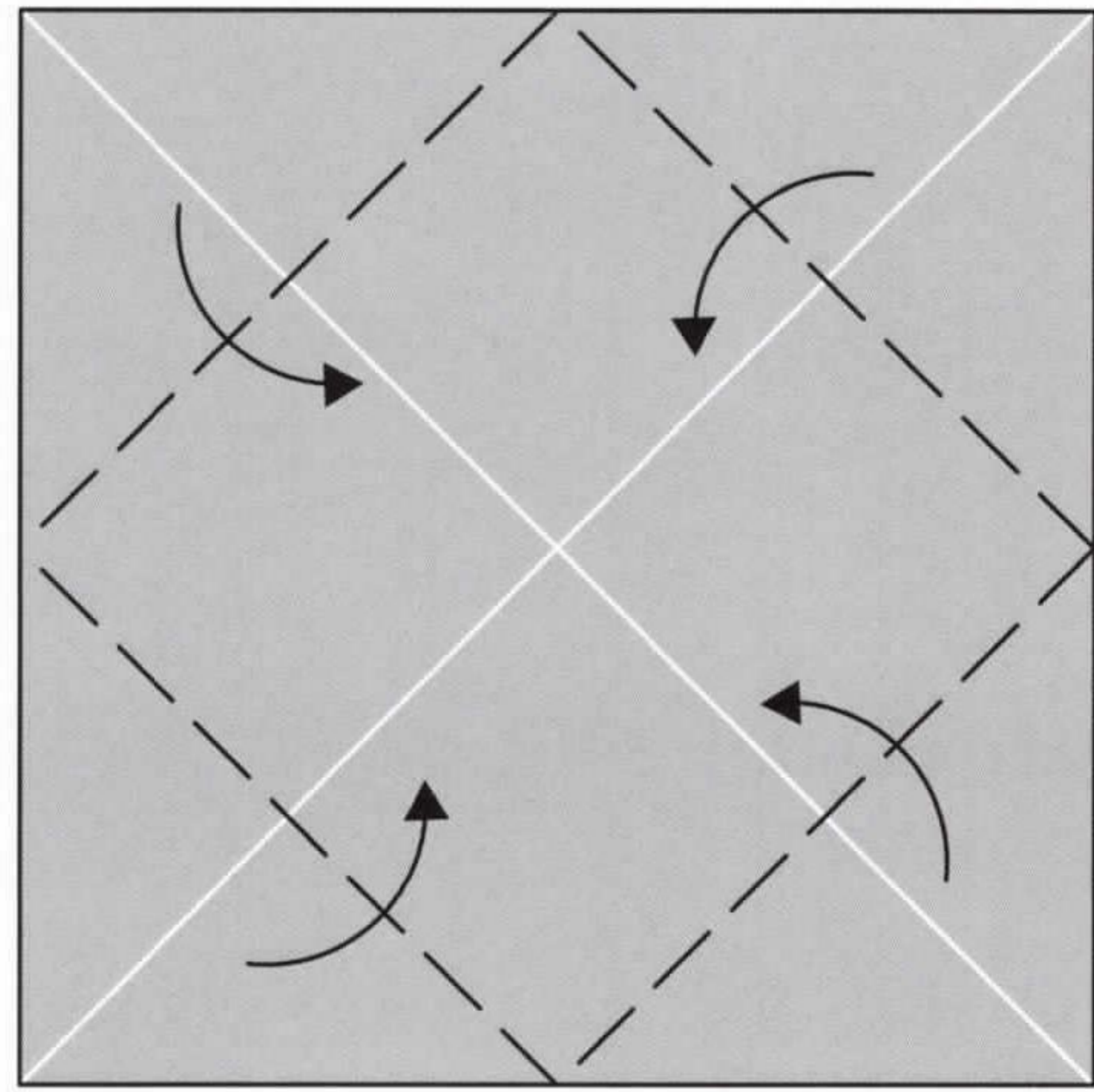

2. Valley folds

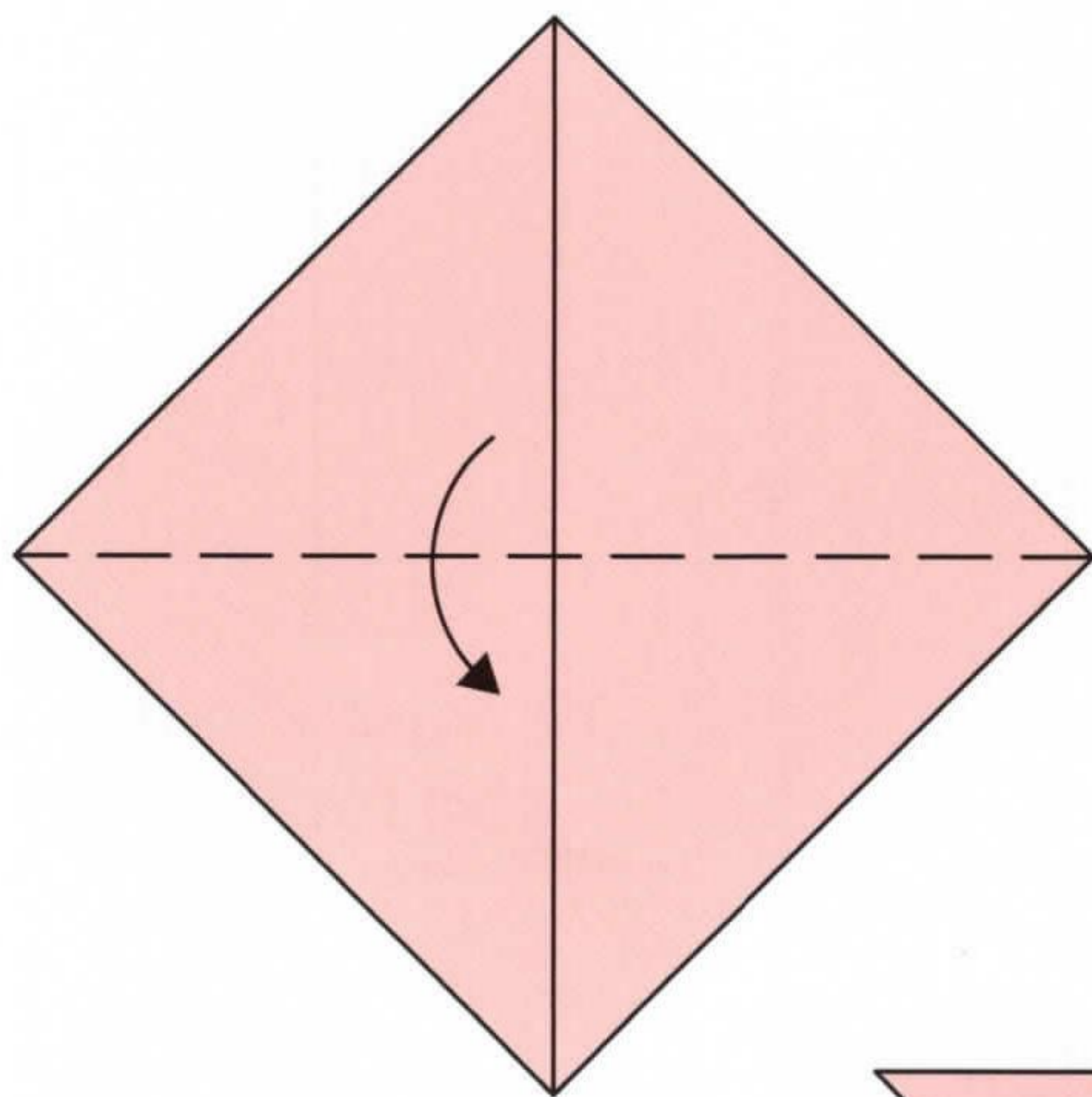

3. Valley fold and scale-up

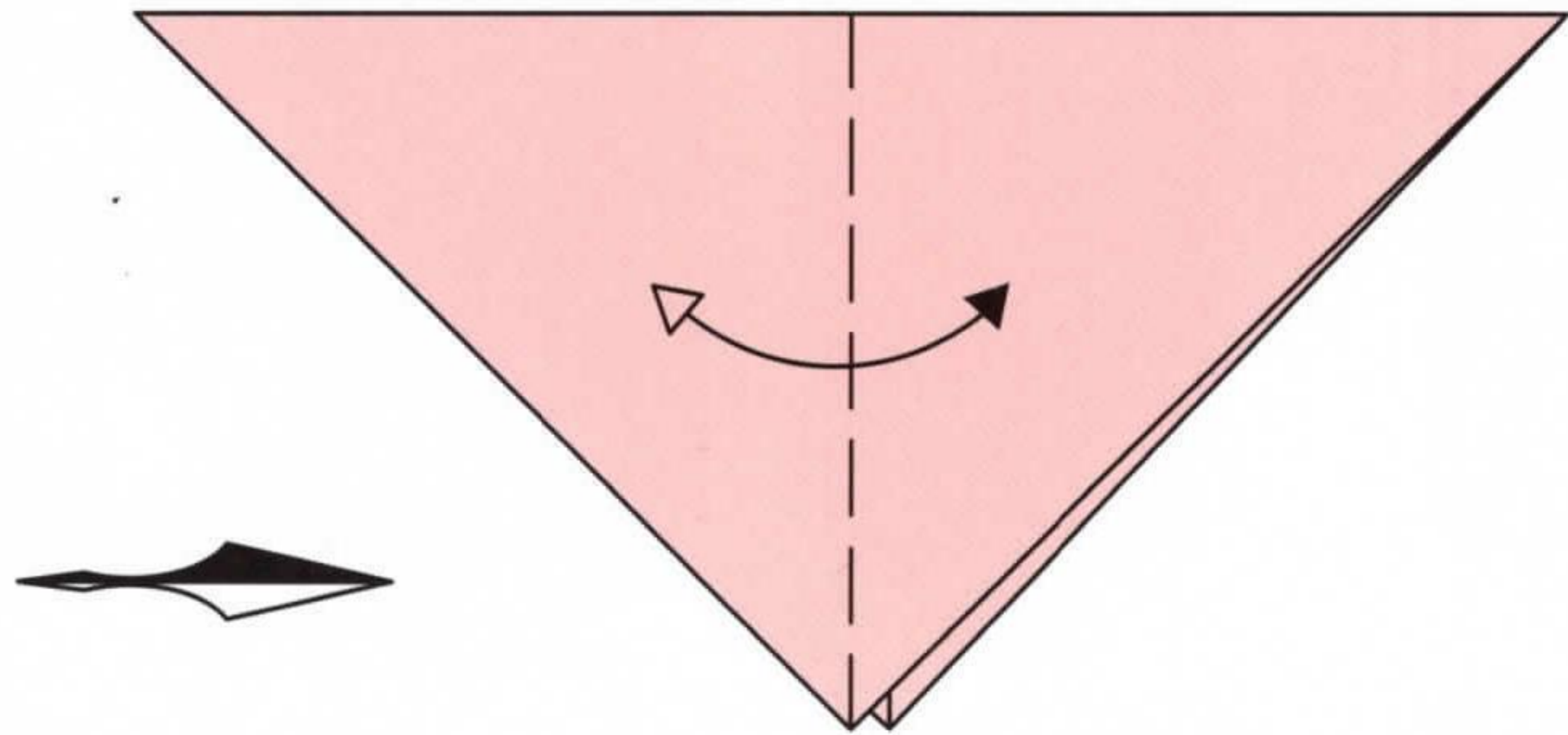

4. Valley fold and unfold

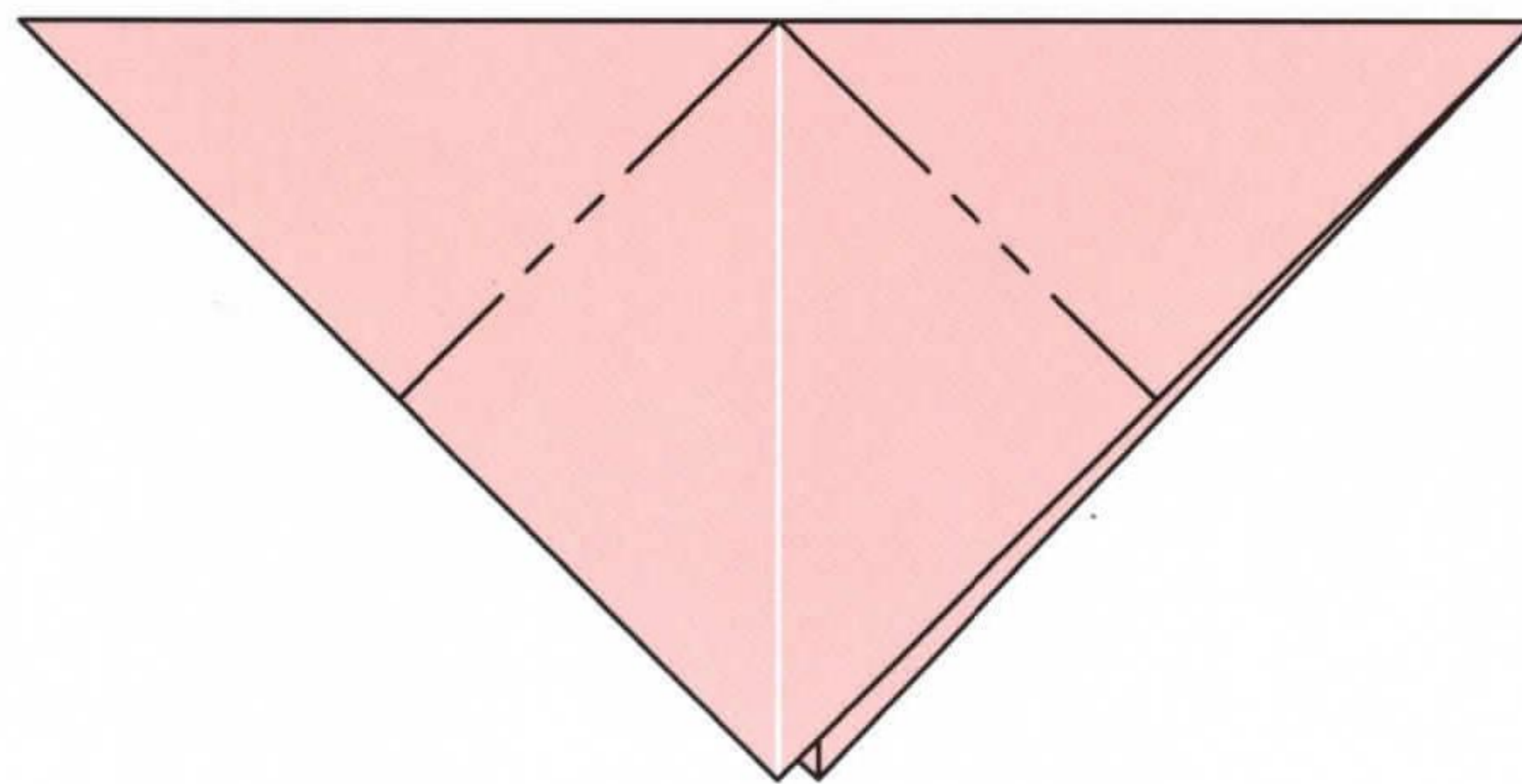

5. Inside reverse folds

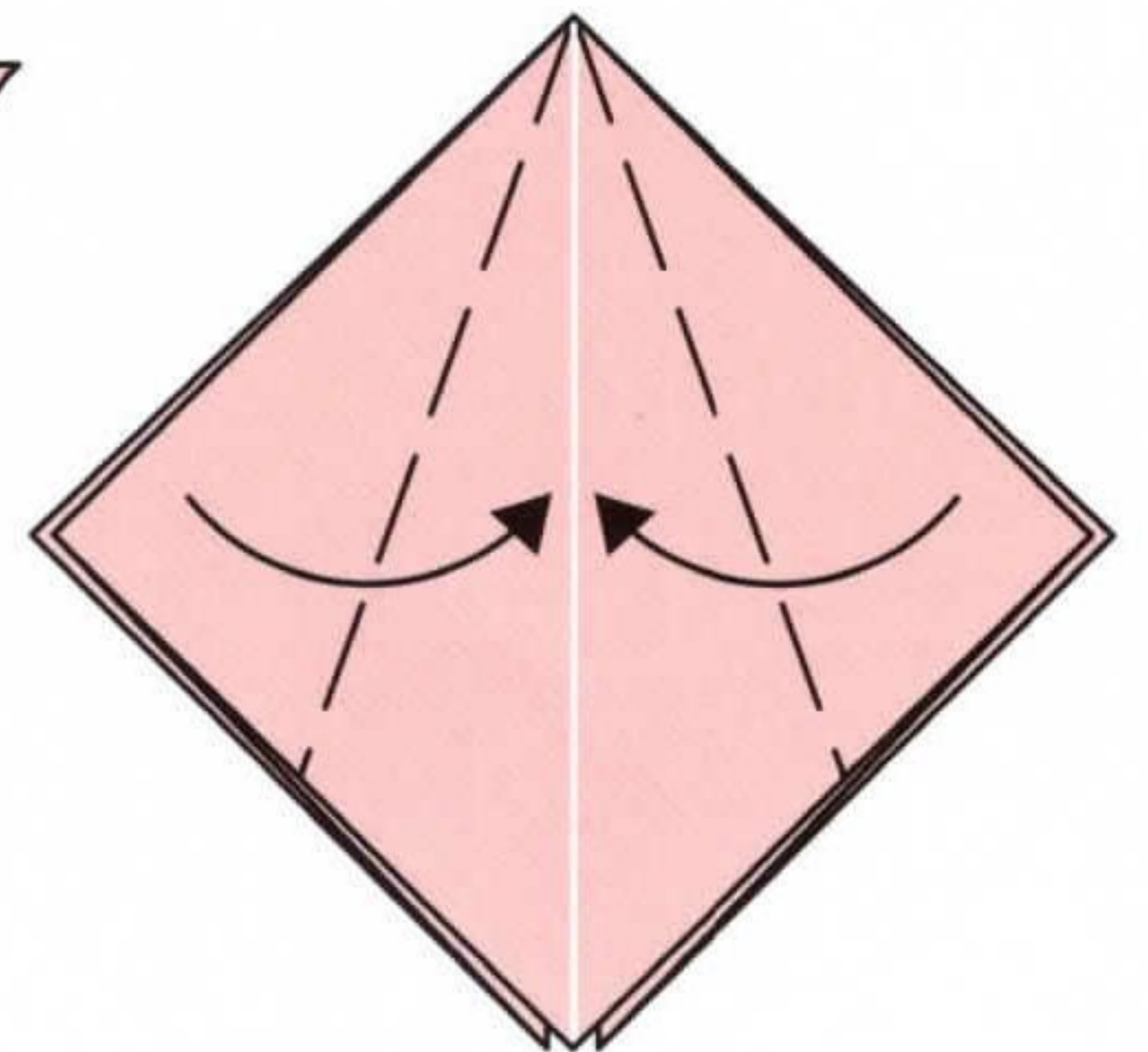

6. Valley folds

toilet: part 2

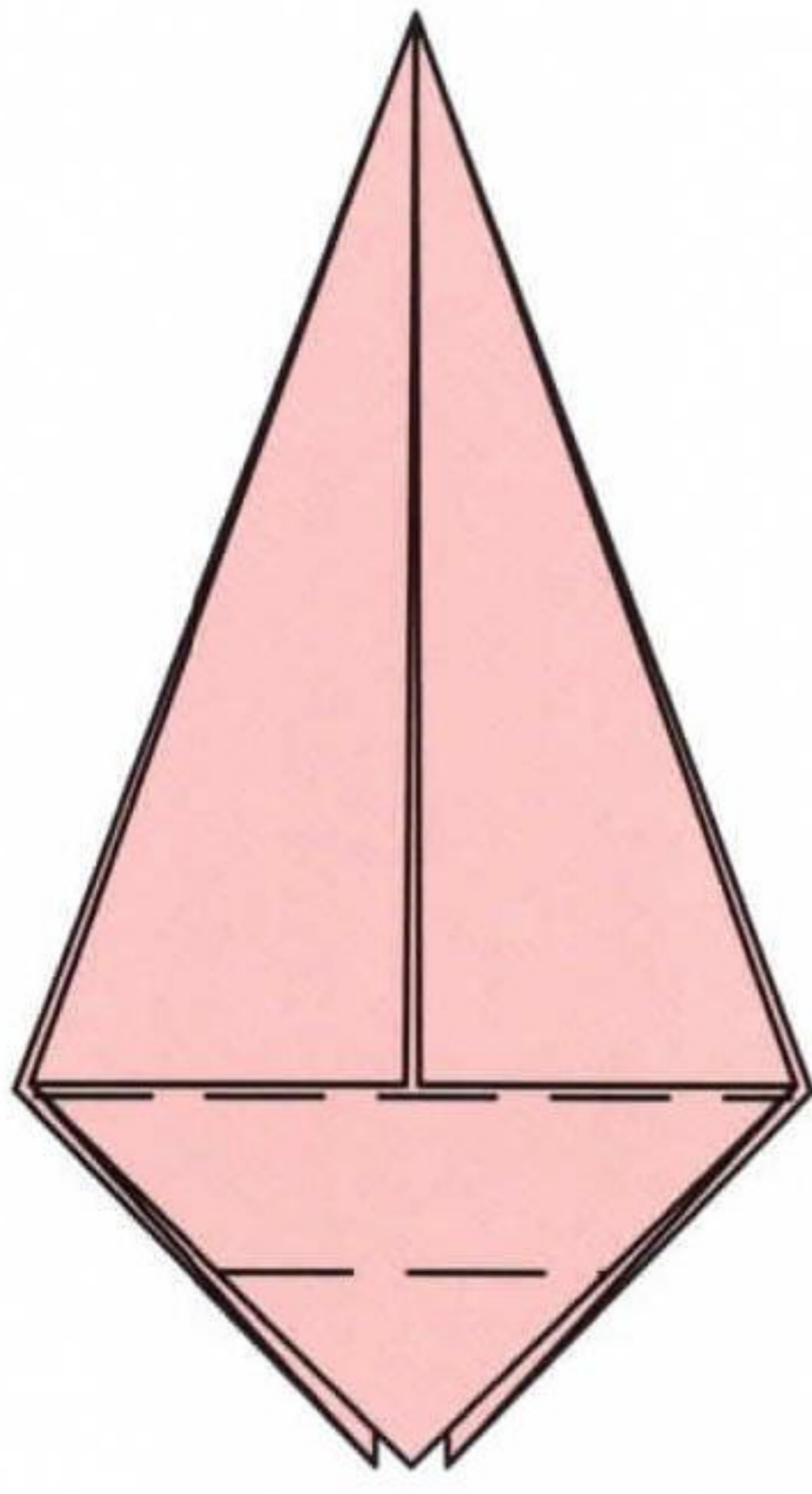

7. Valley fold both sides

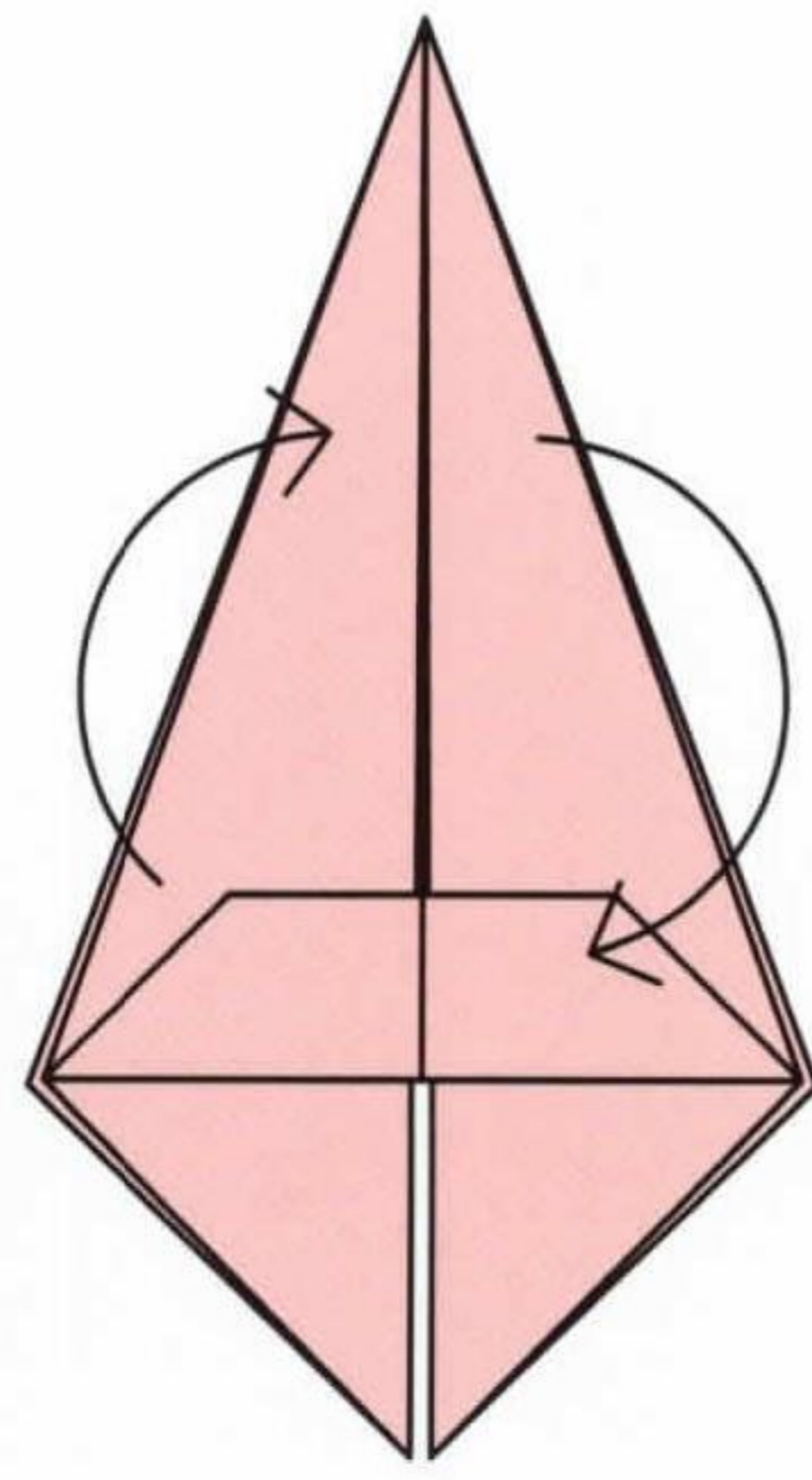

8. Open flaps

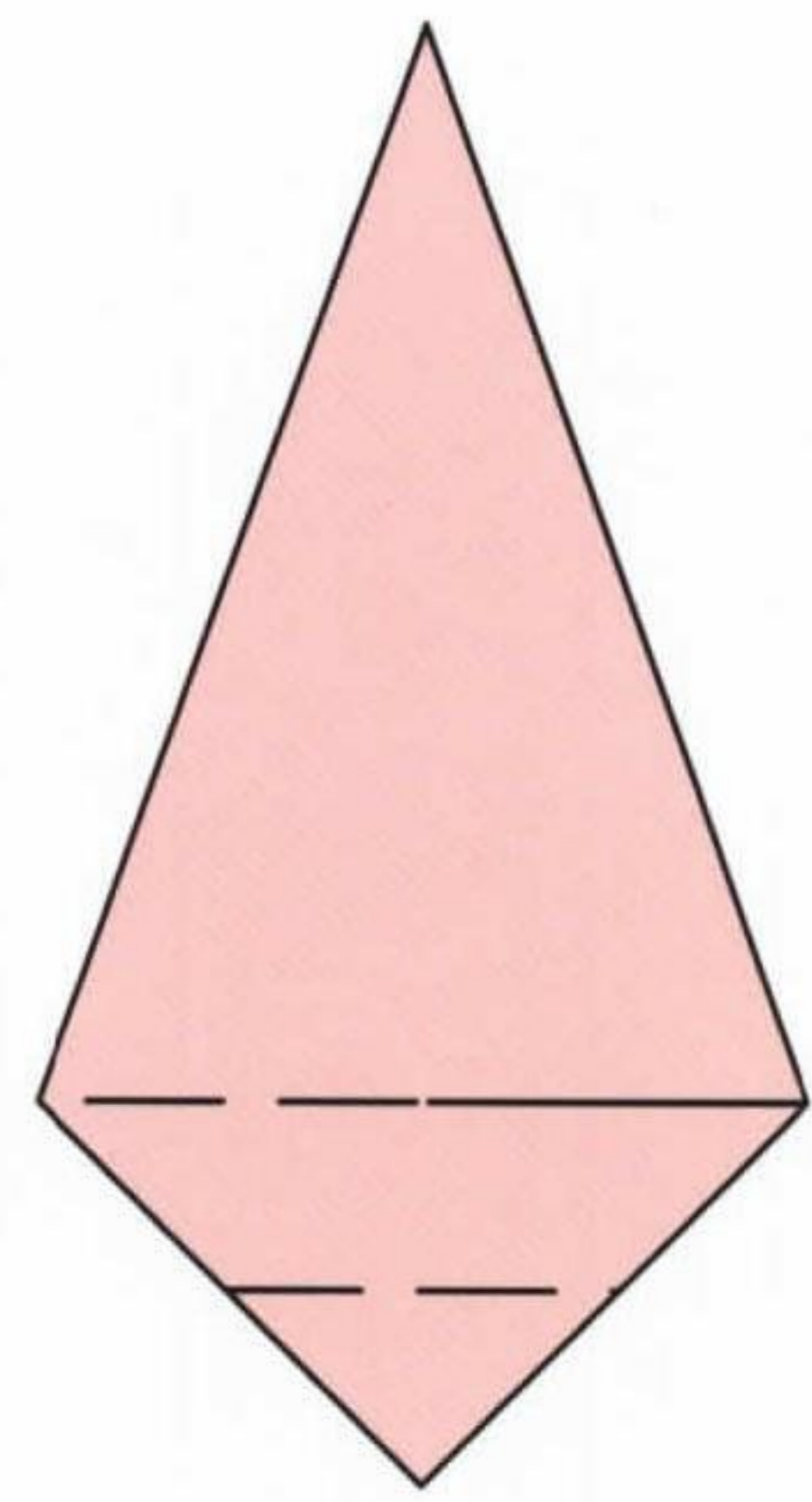

9. Valley folds both sides

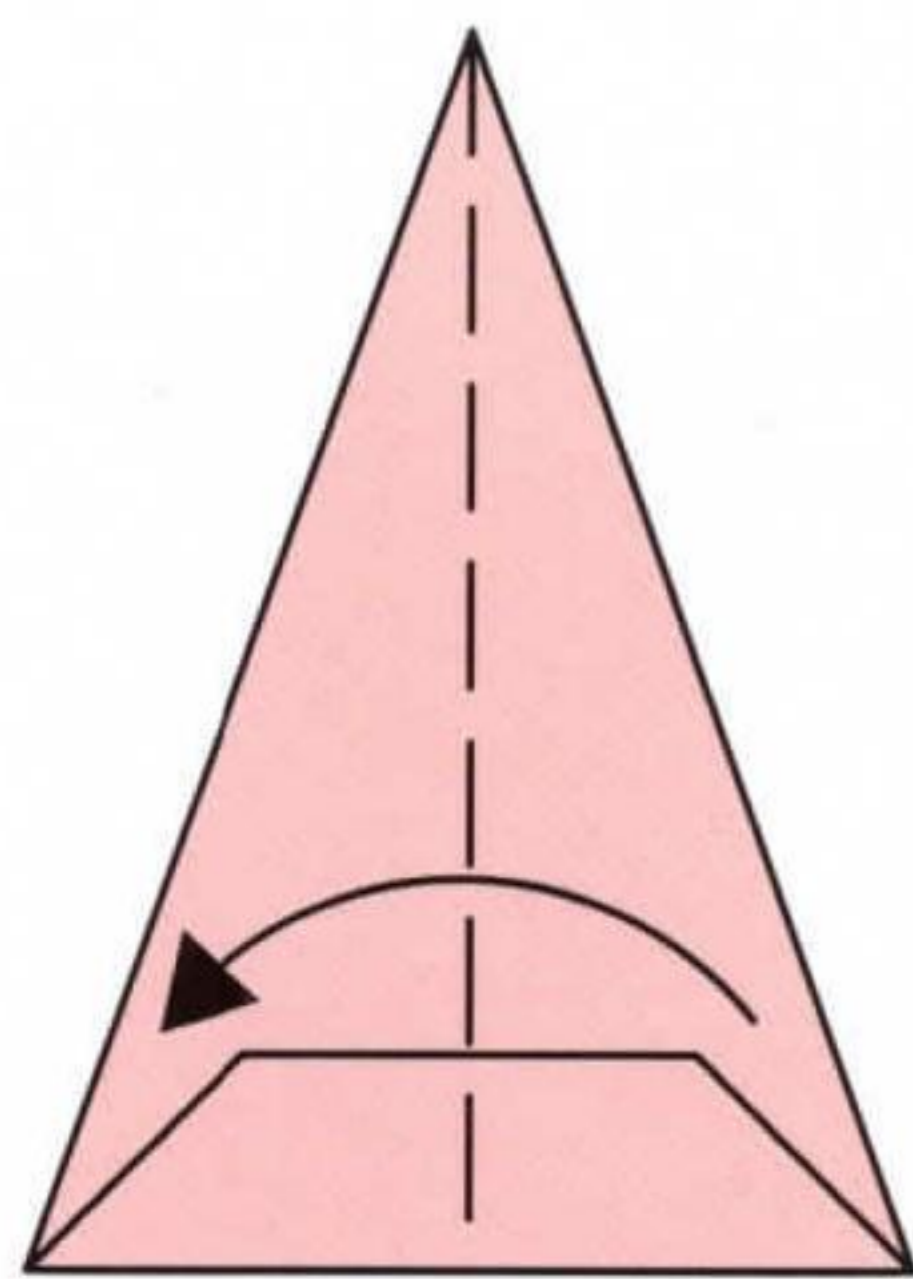

10. Valley fold

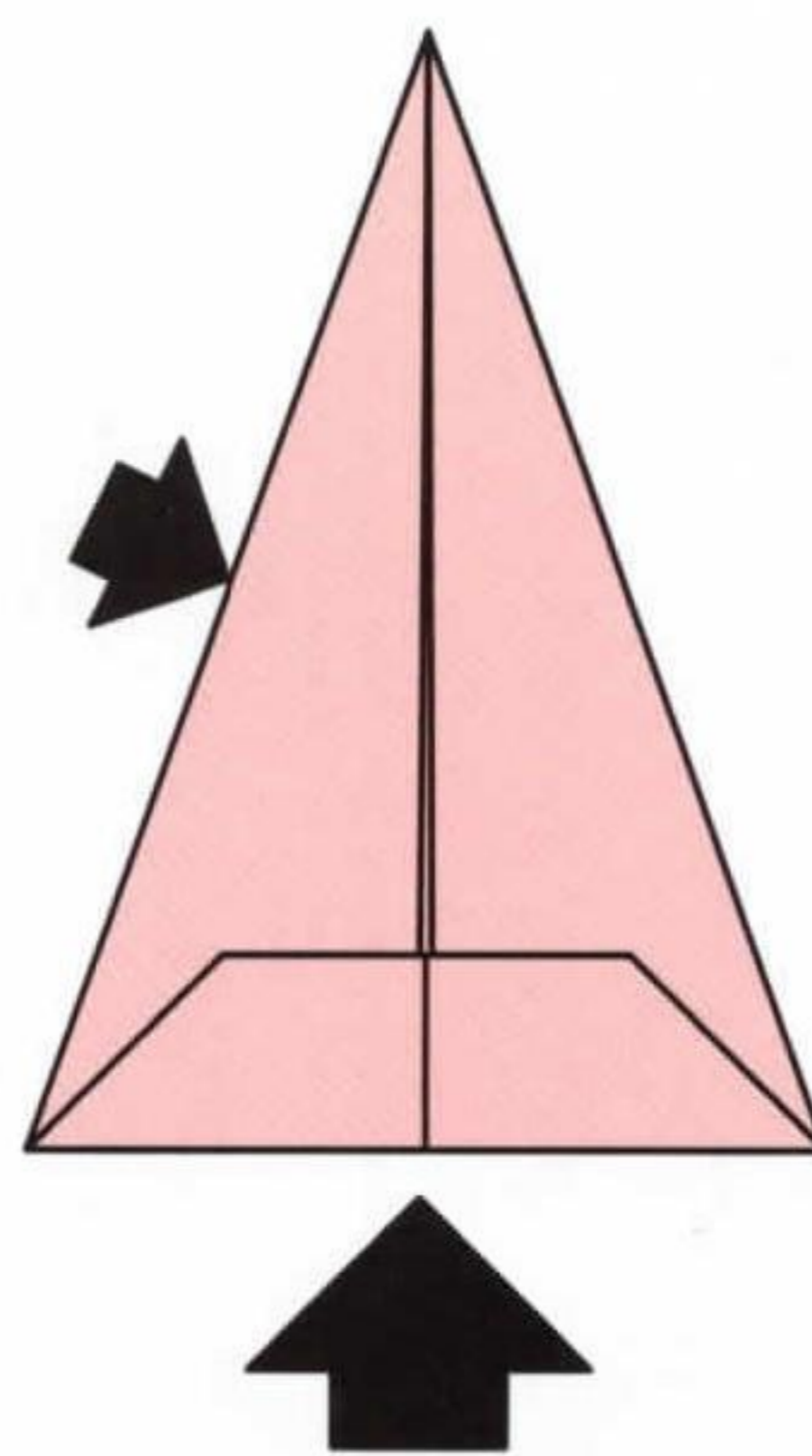

11. Adde glue and push to open

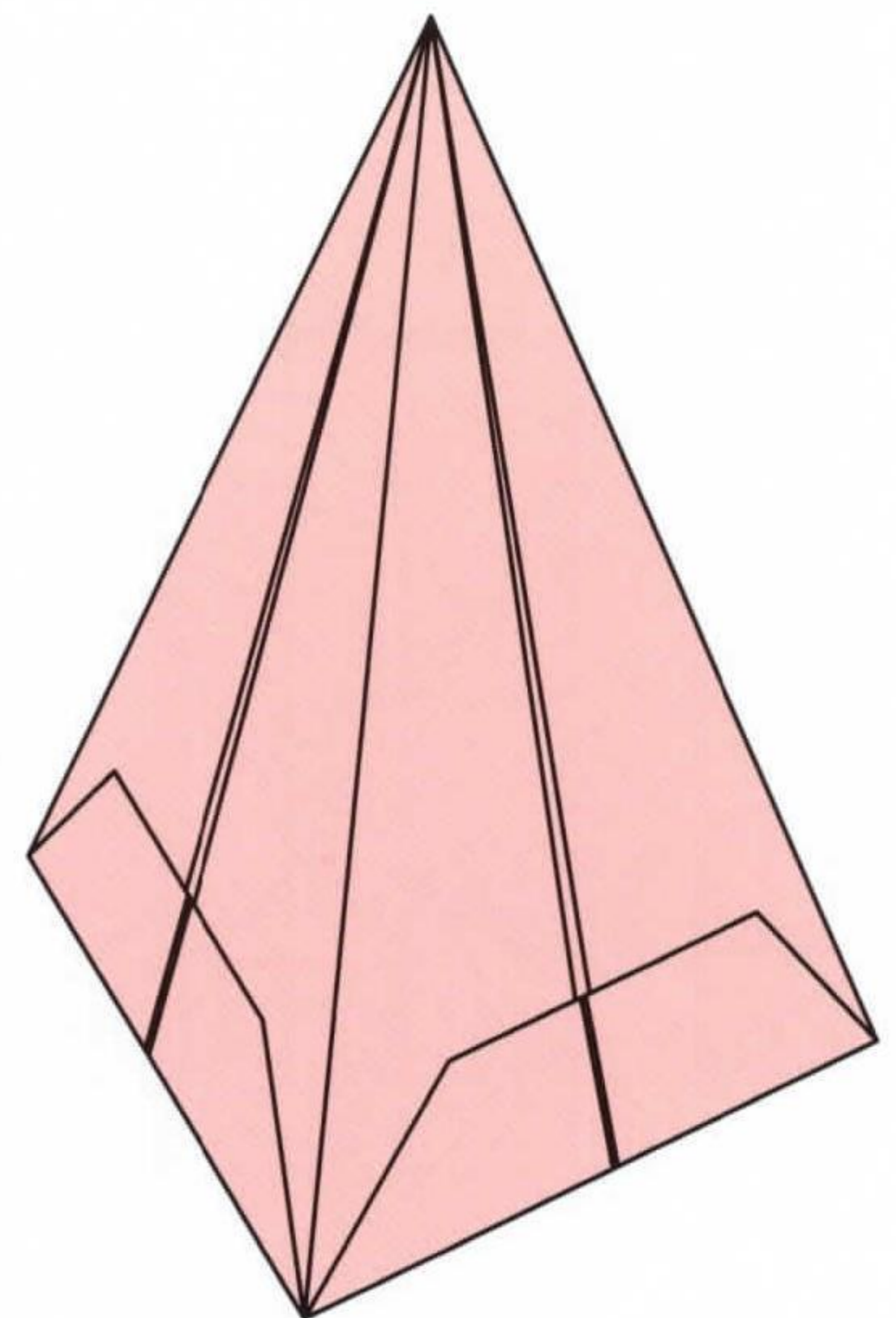

12. Completed PART 2

toilet: part 3

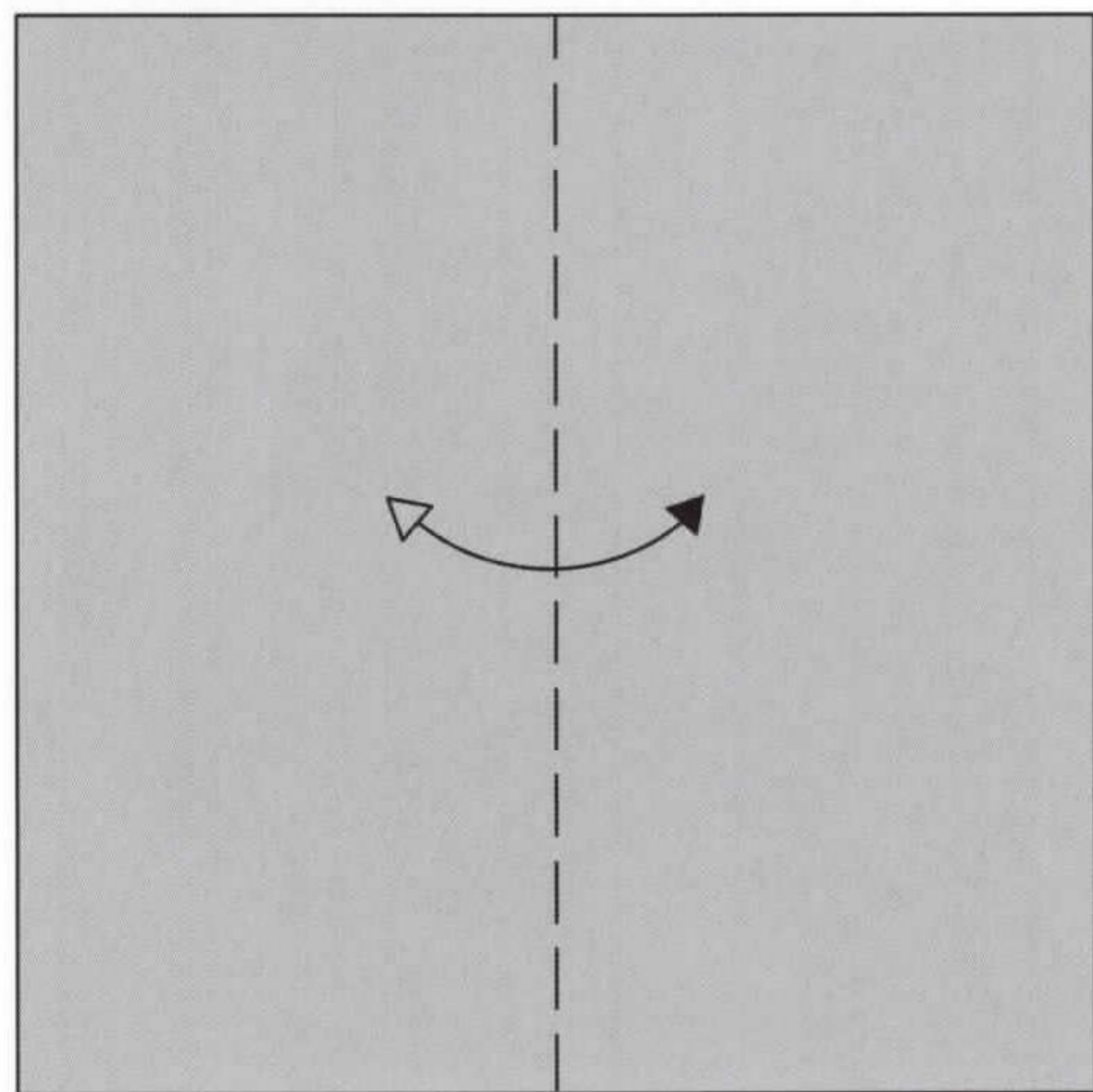

1. Valley fold and unfold

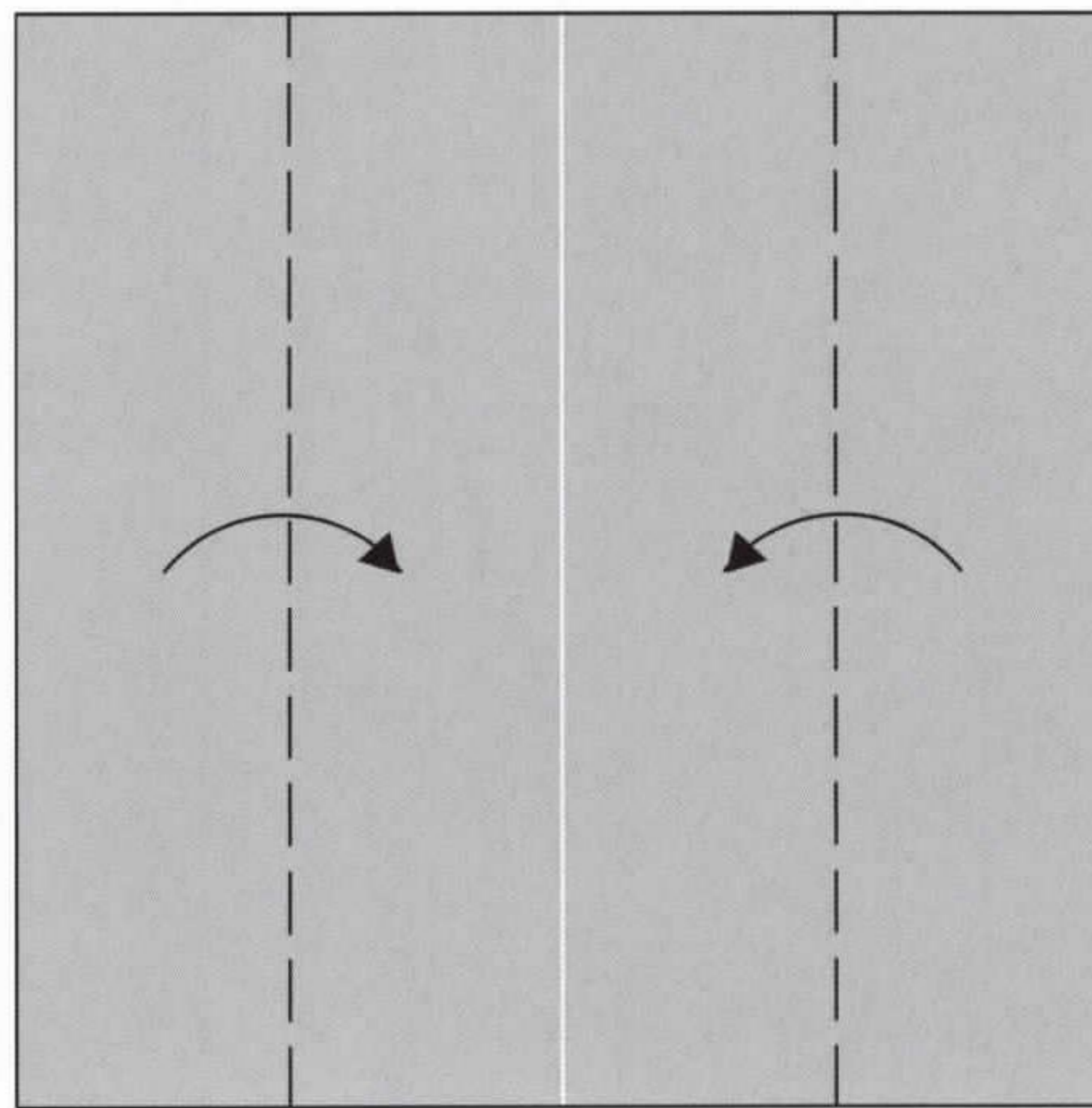

2. Valley folds

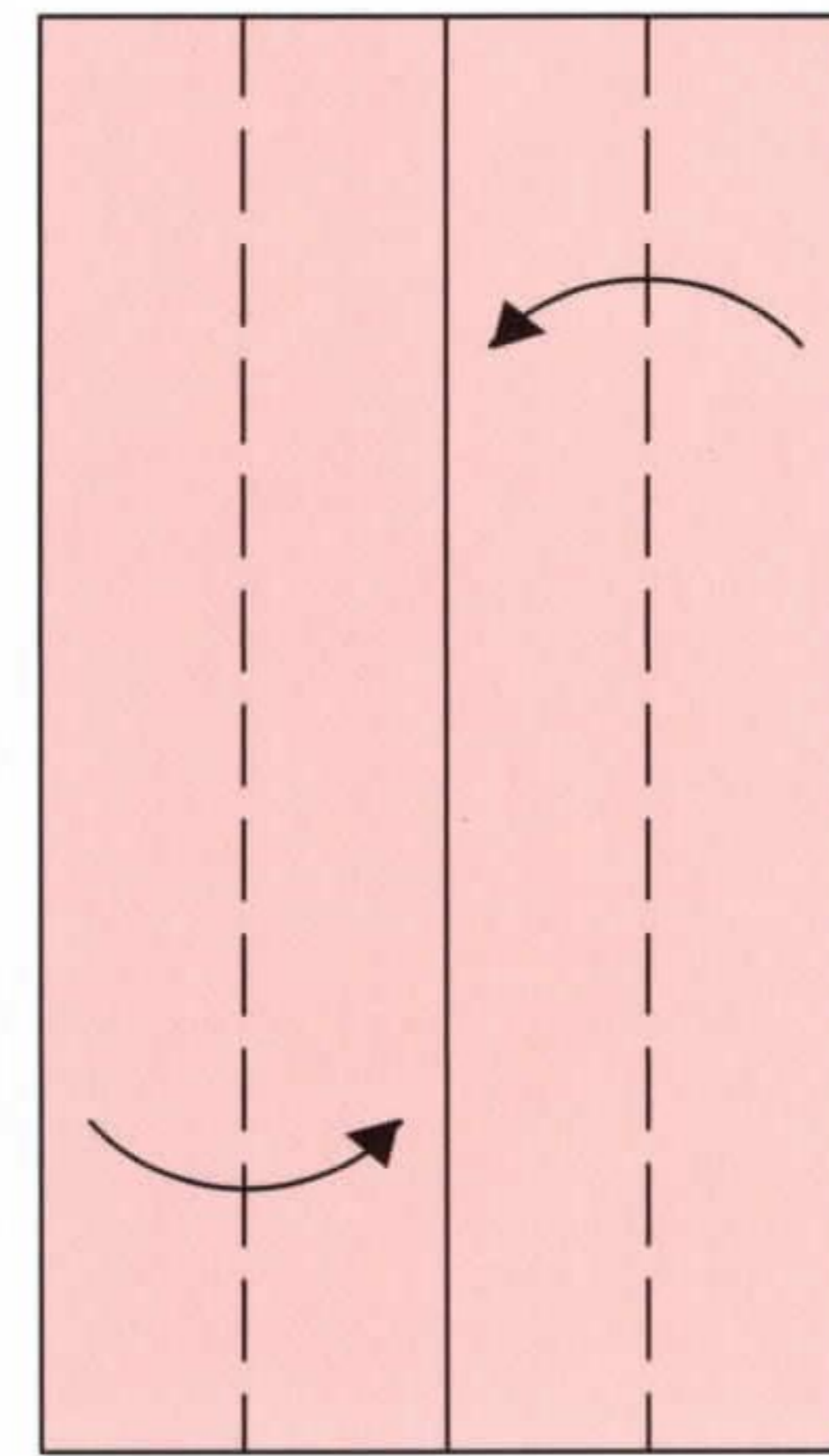

3. Valley folds

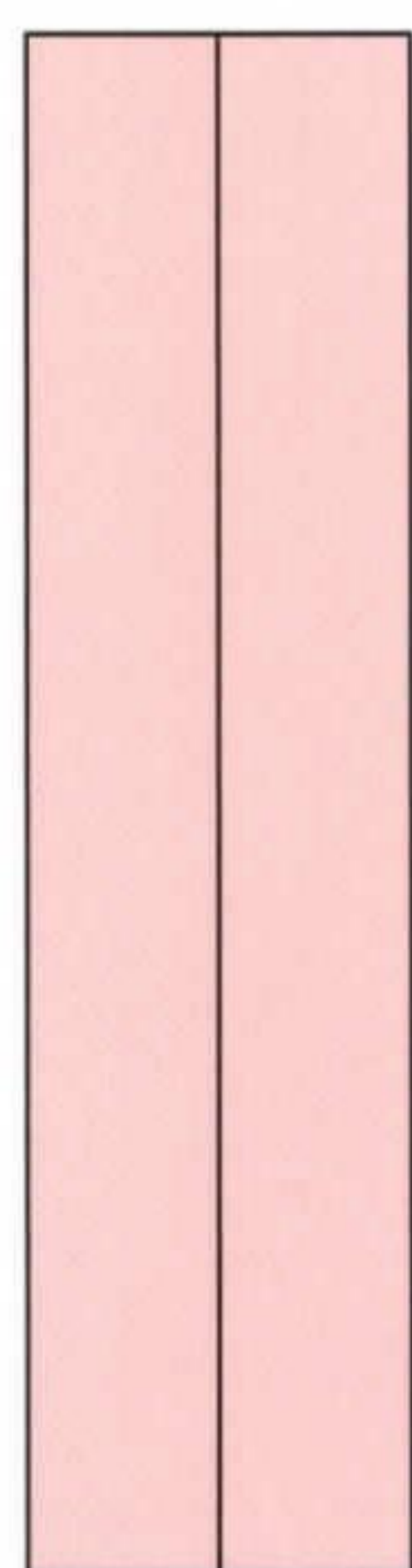

4. Scale-up

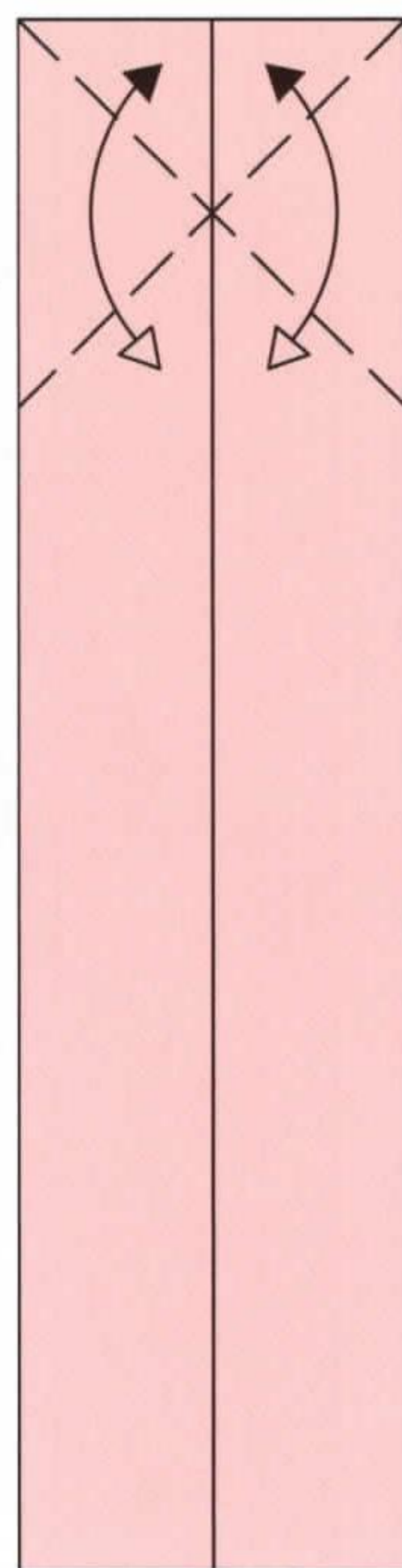

5. Valley folds and unfold

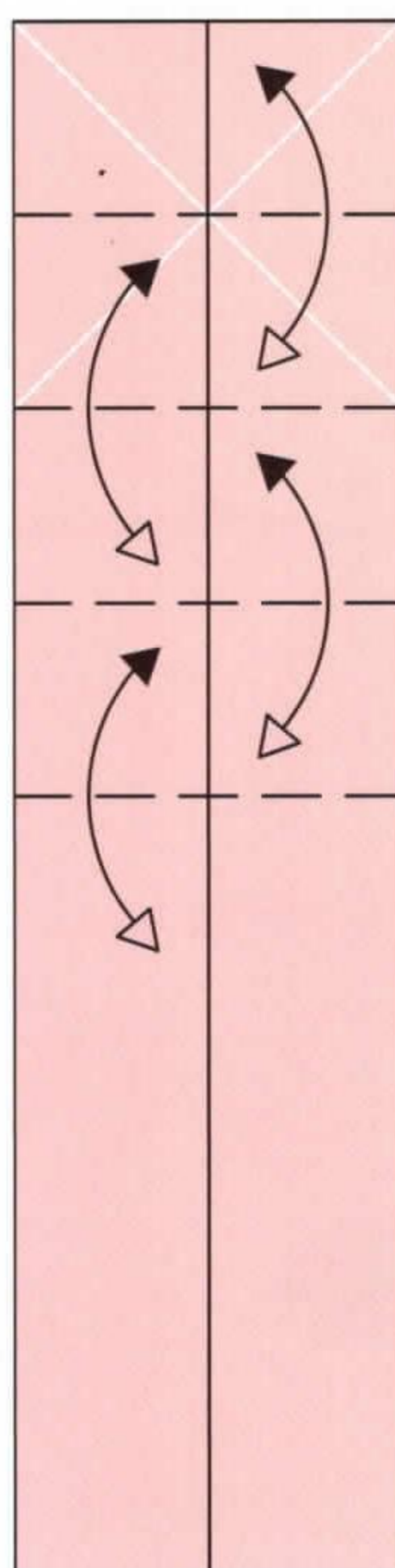

6. Repeat

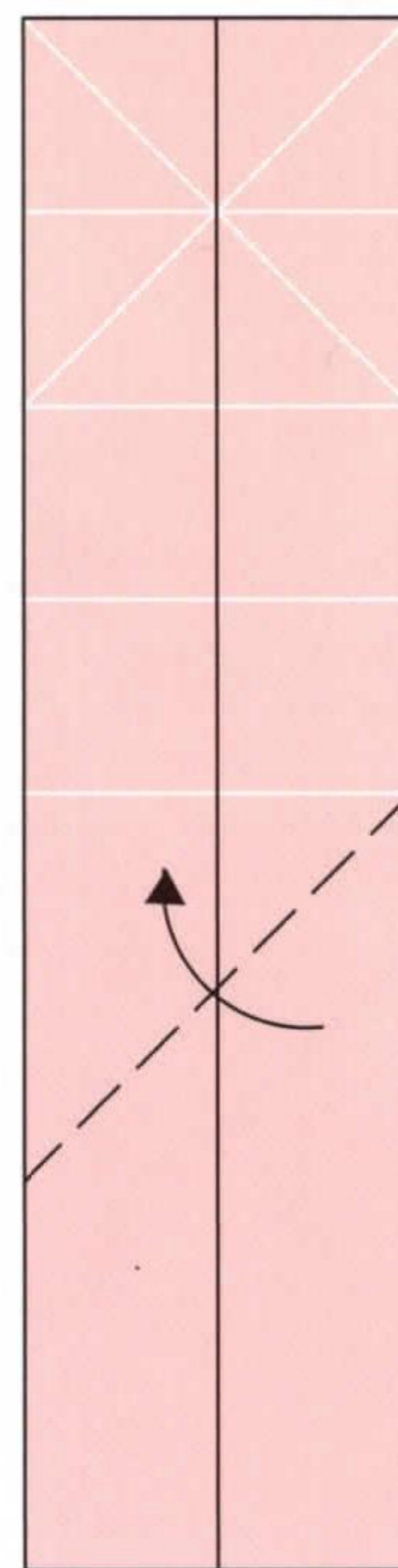

7. Valley fold

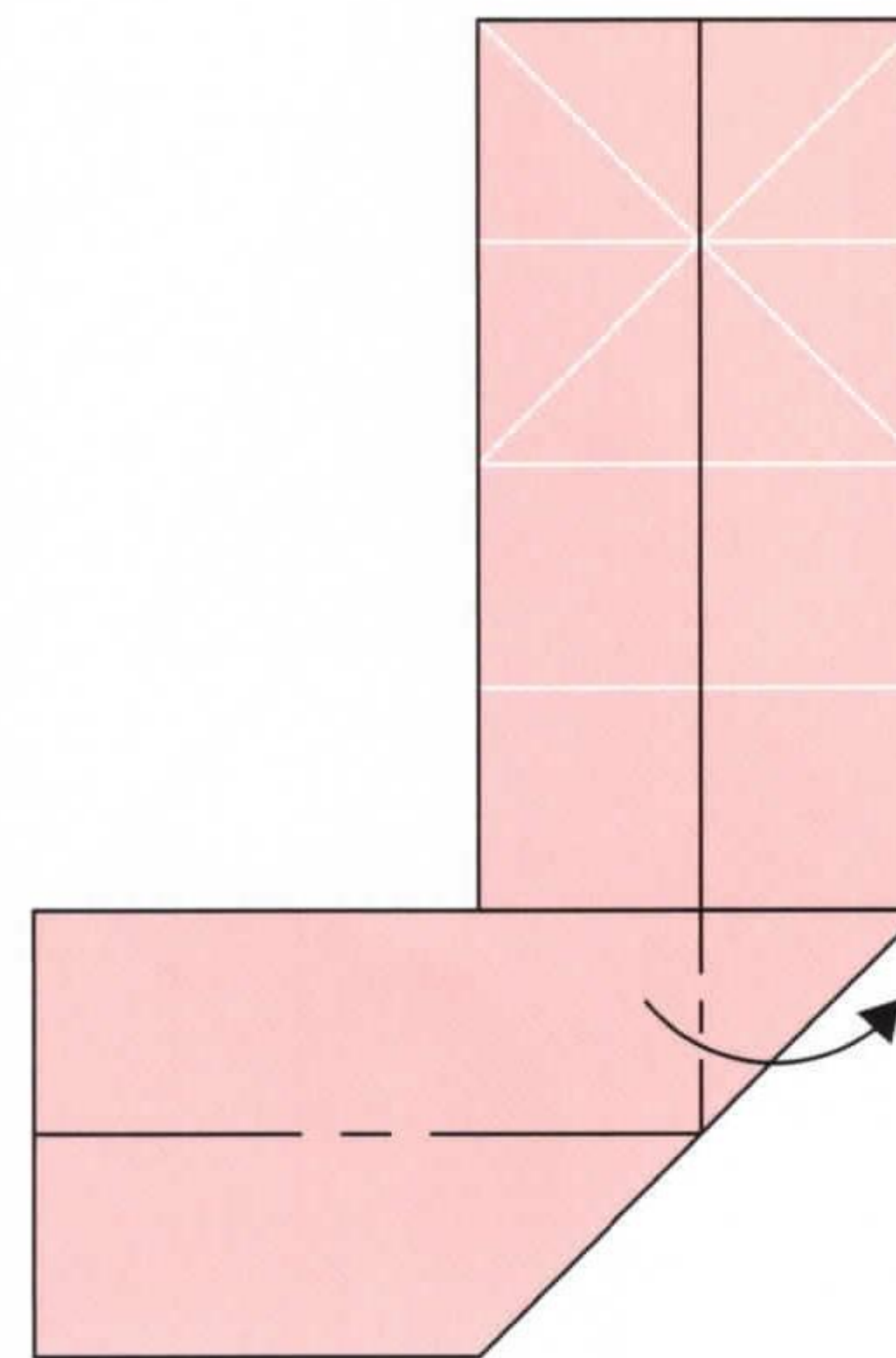

8. Squash fold

toilet: part 3

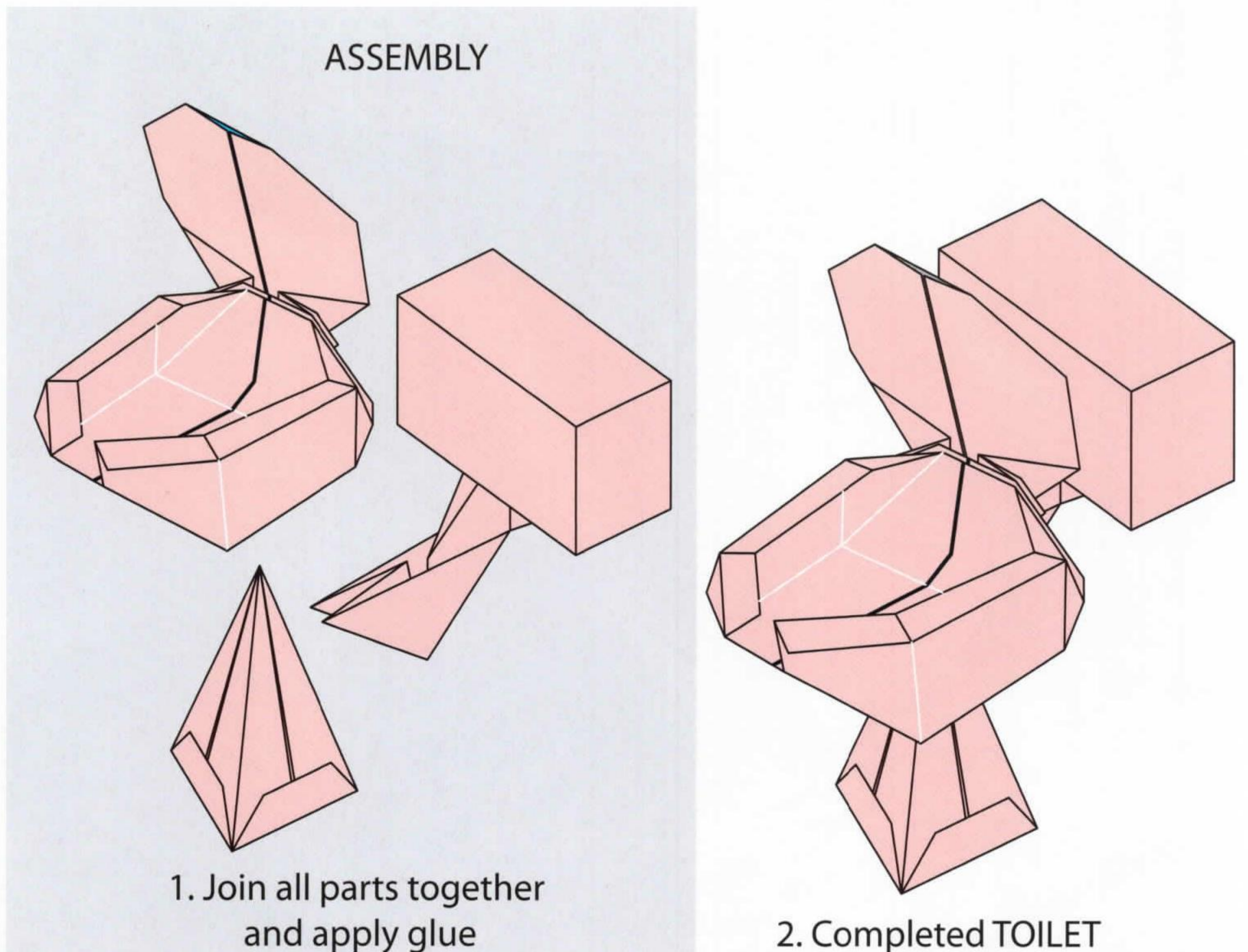
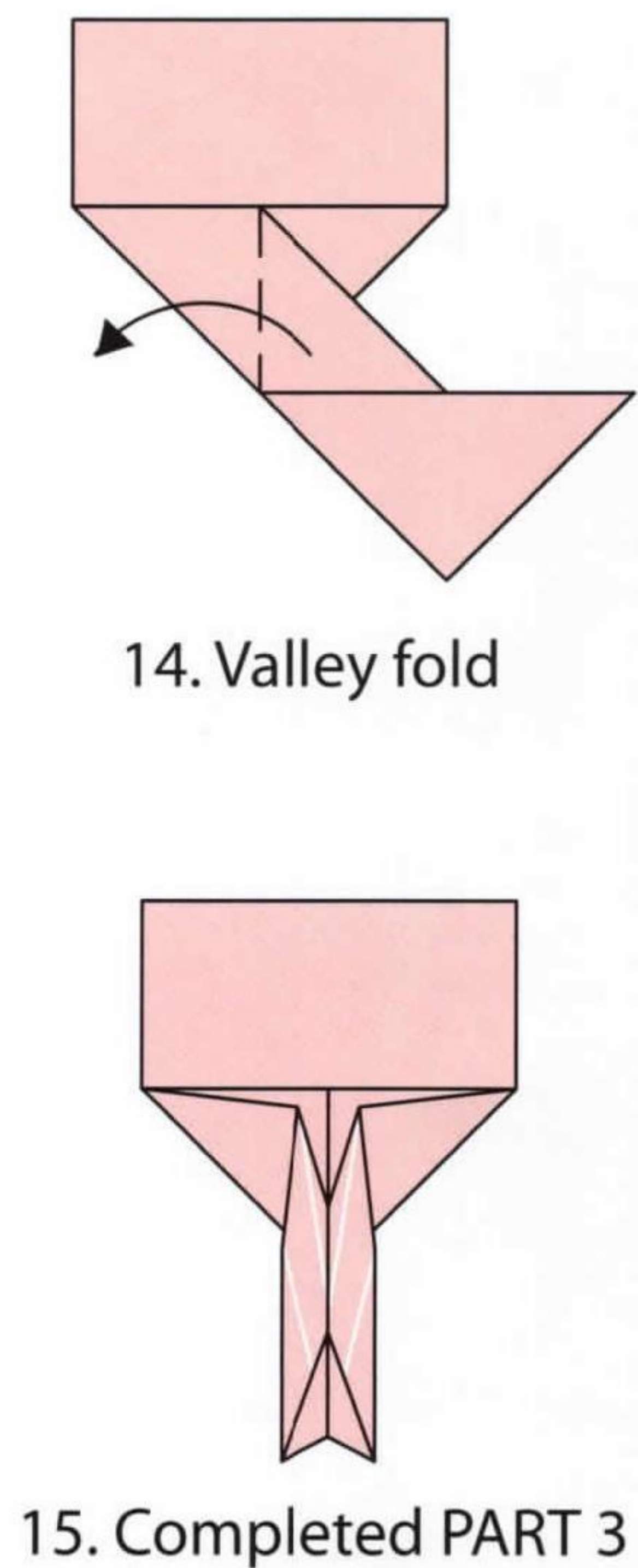
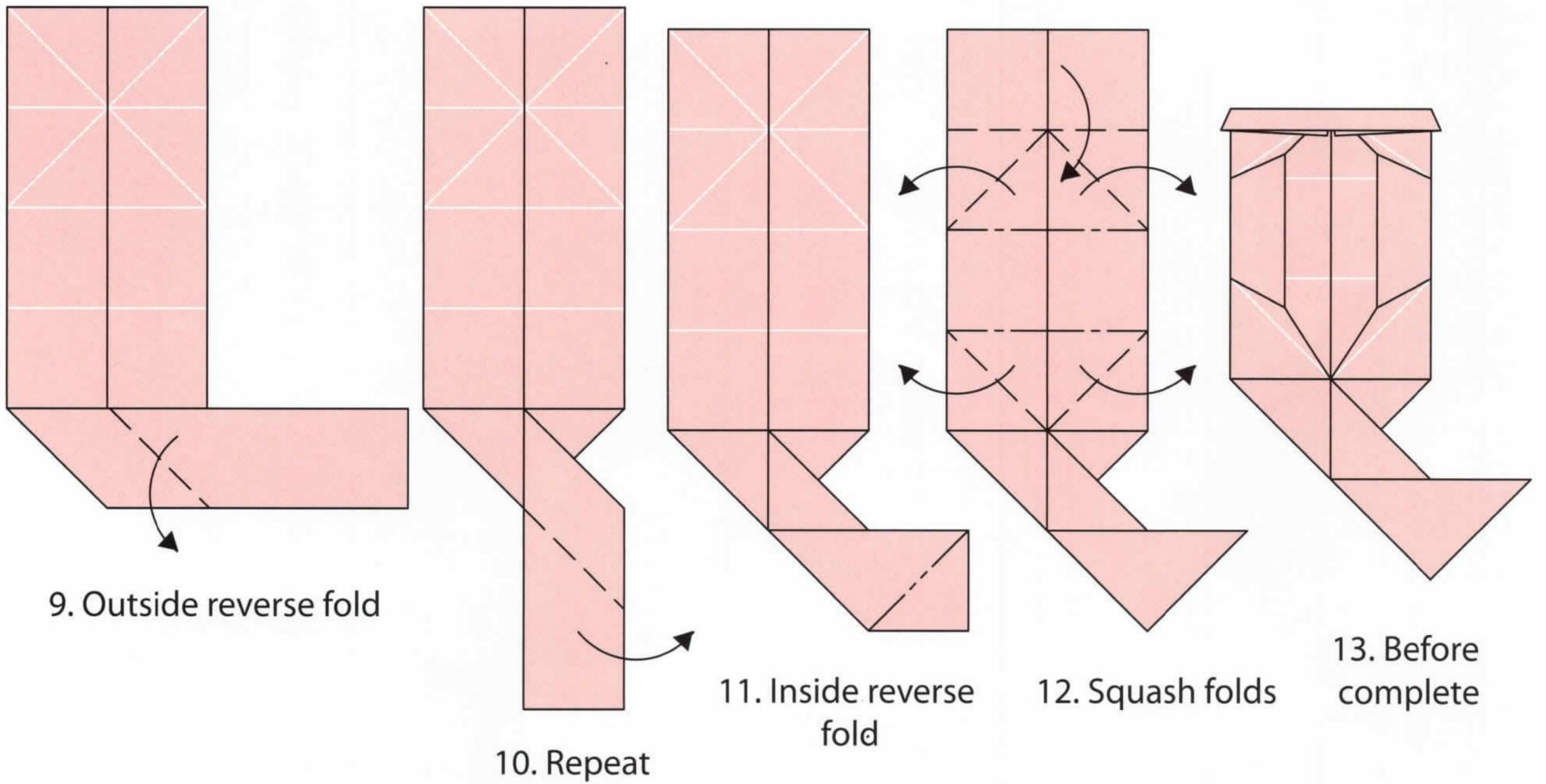



7

vanity set

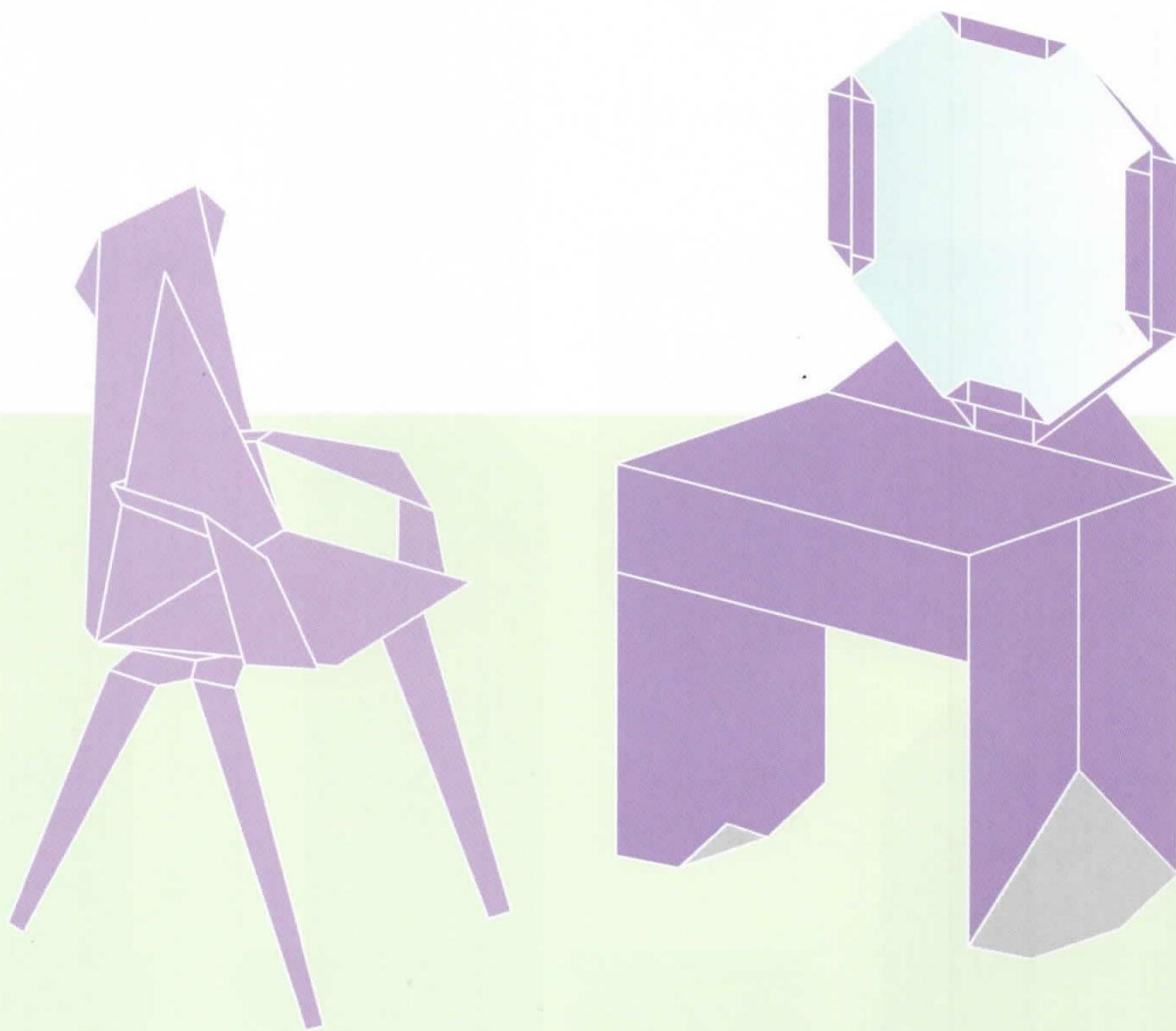

vanity table | vanity chair

► vanity table: part 1

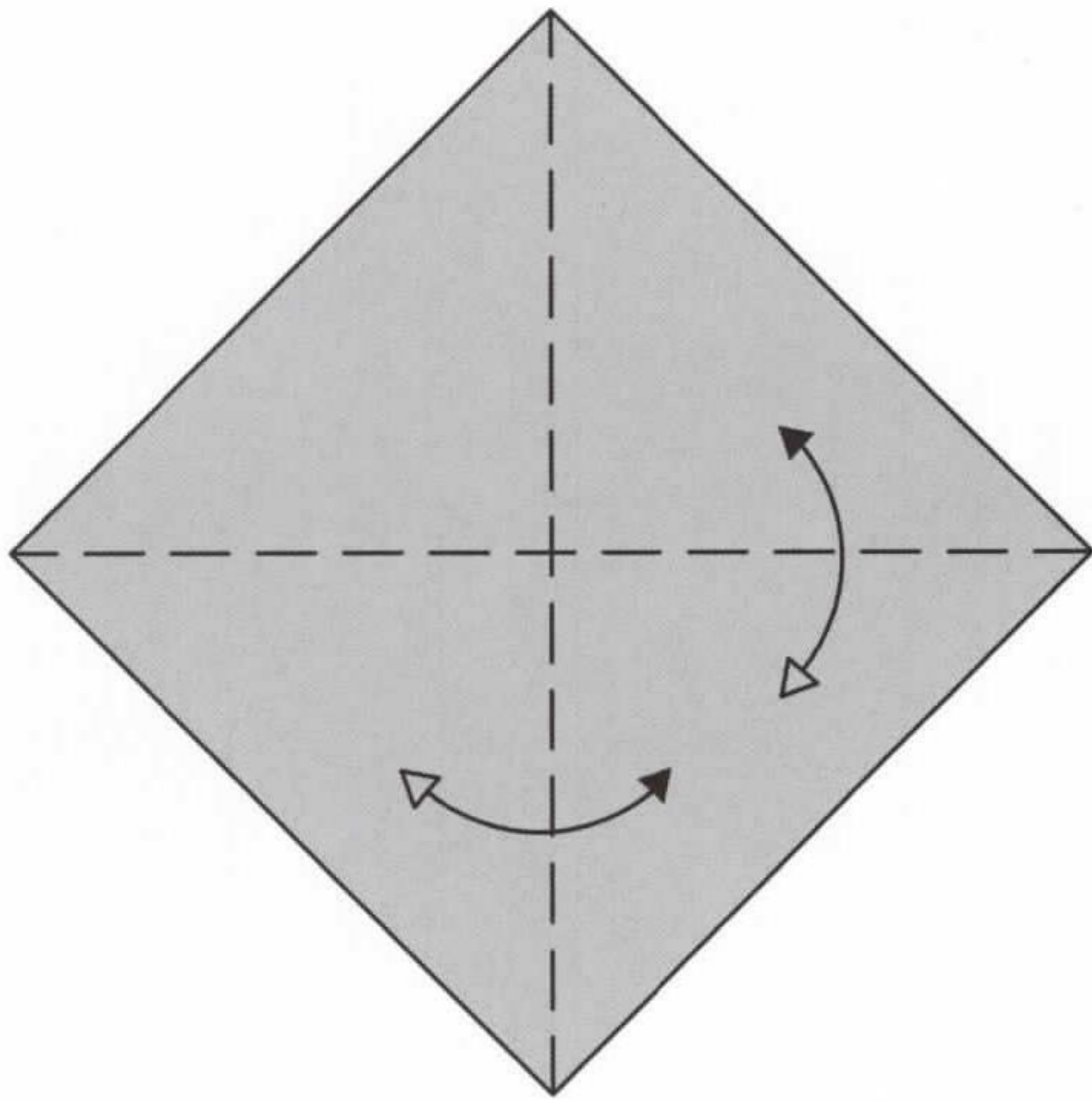

1. Valley folds and unfold

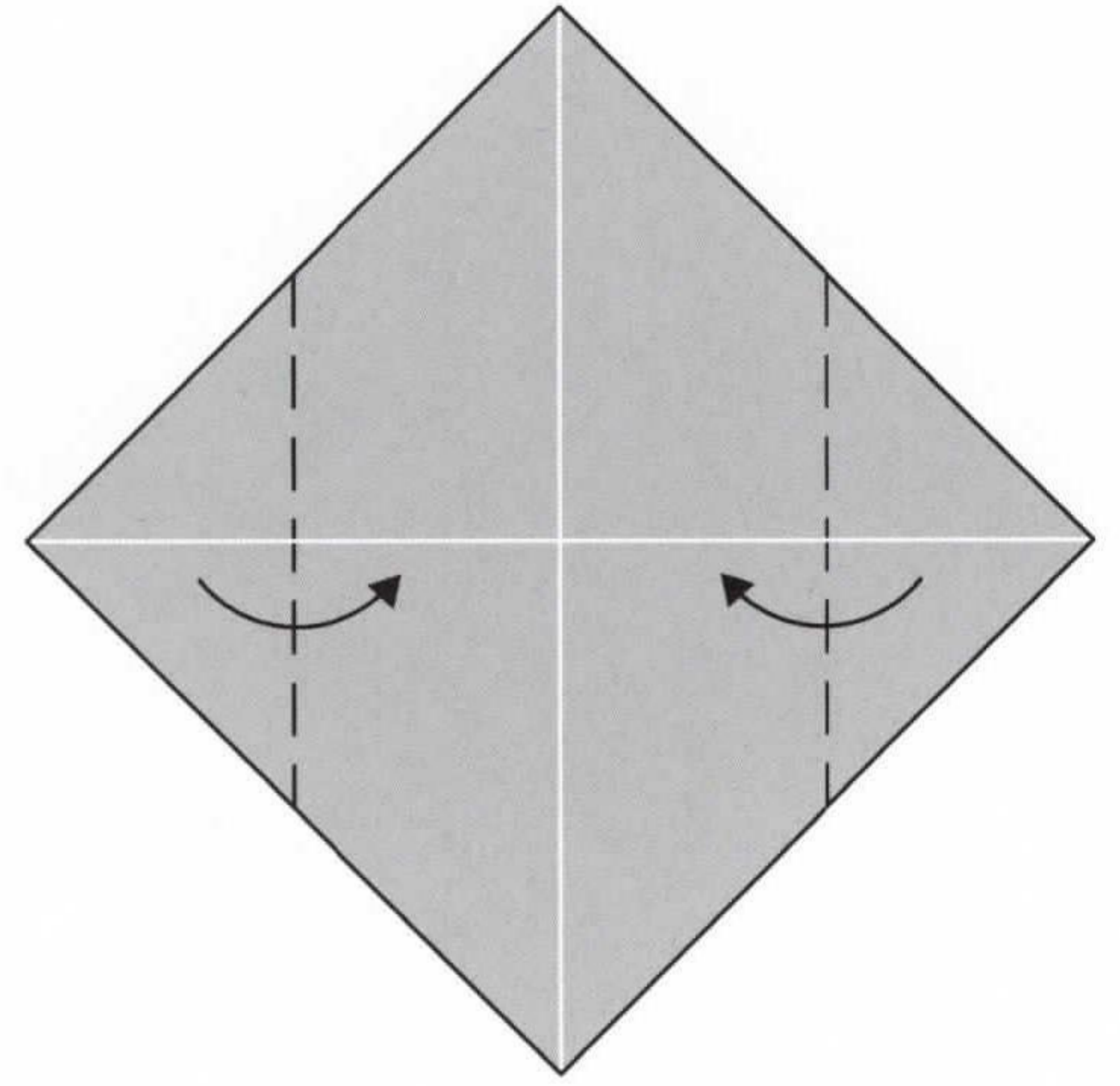

2. Valley folds

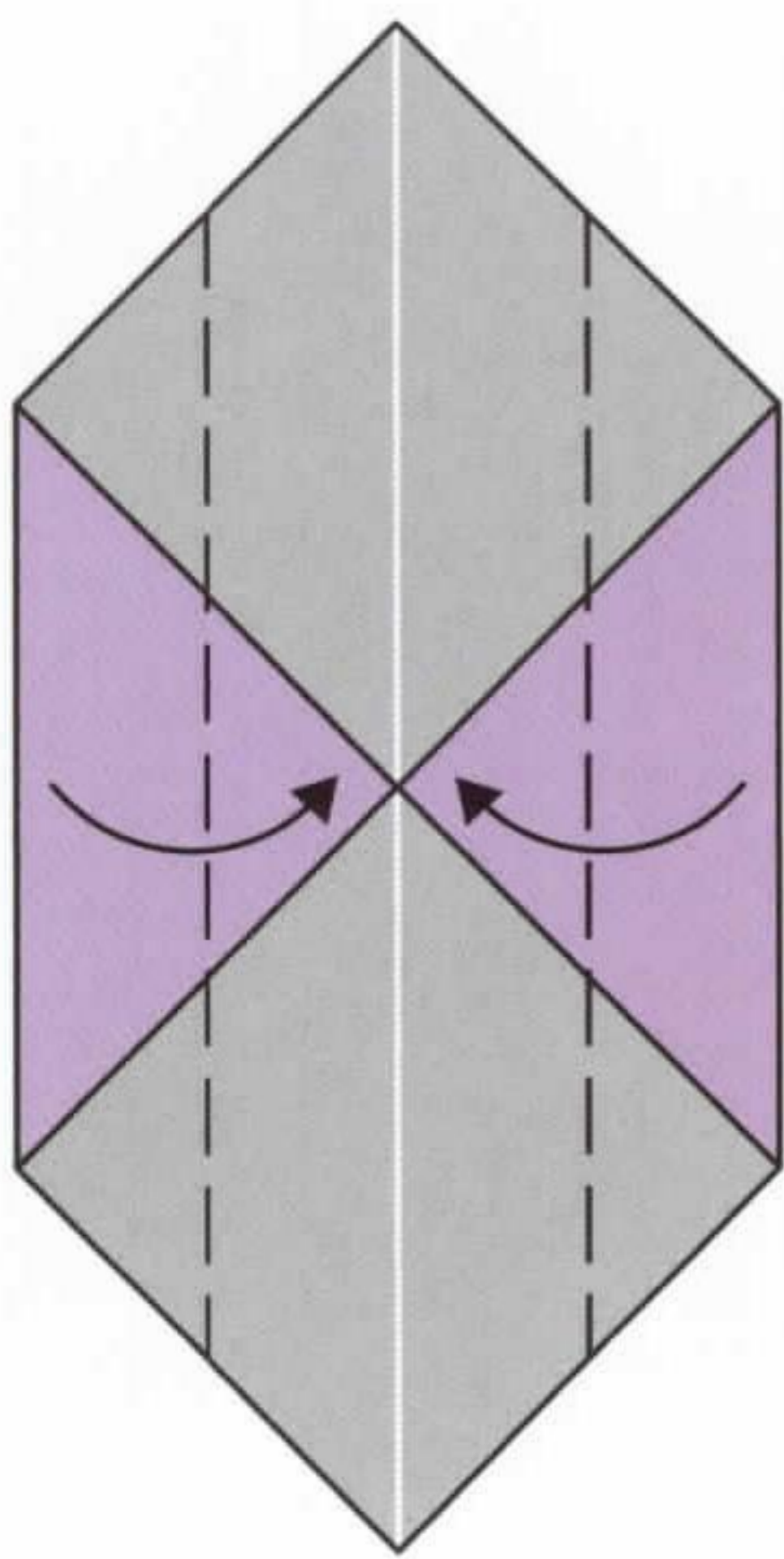

3. Valley folds

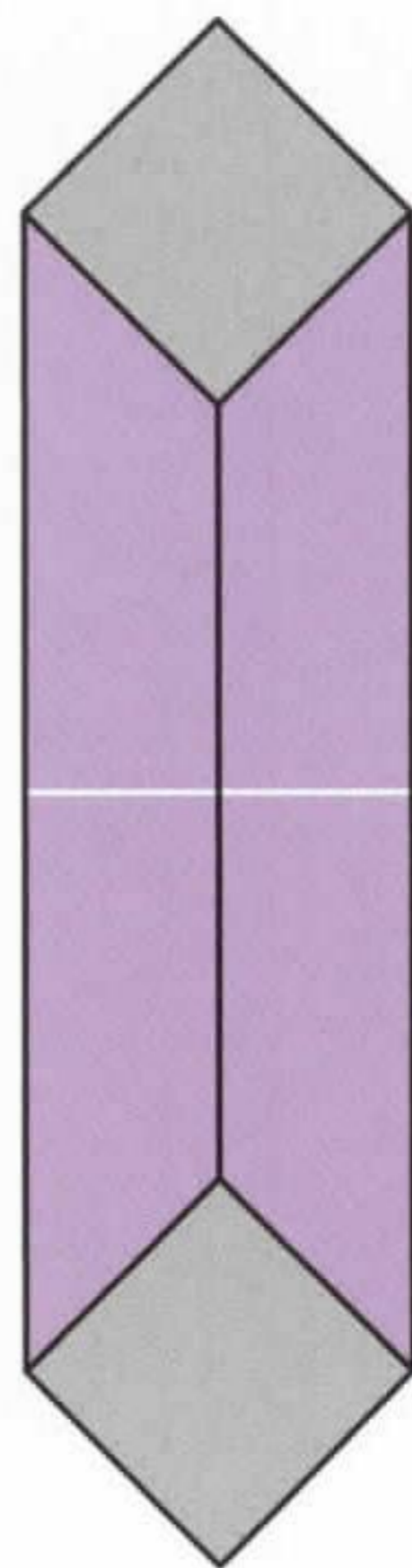

4. Scale-up

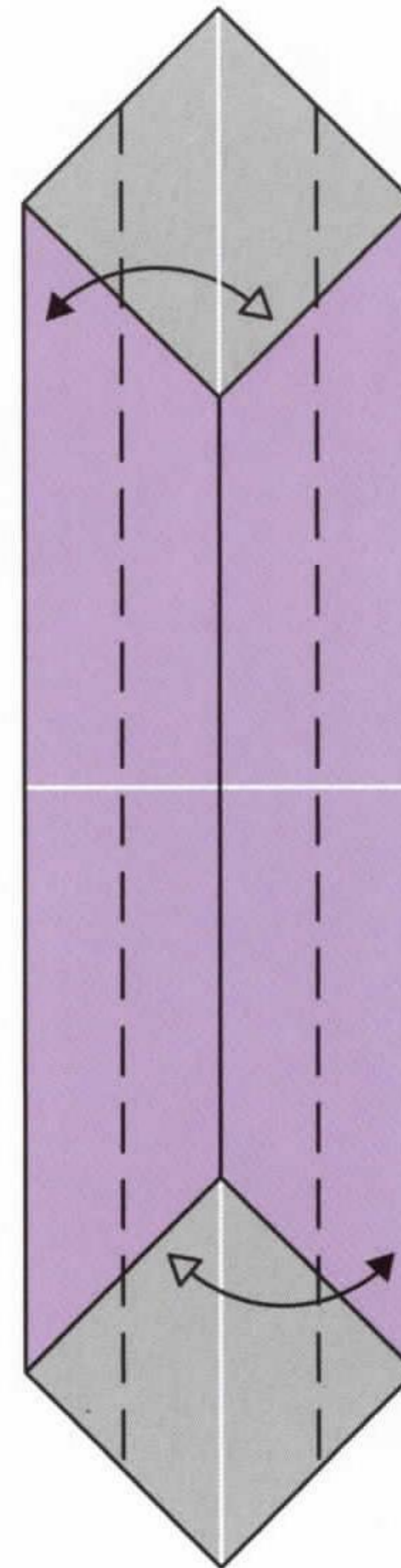

5. Valley folds and unfold

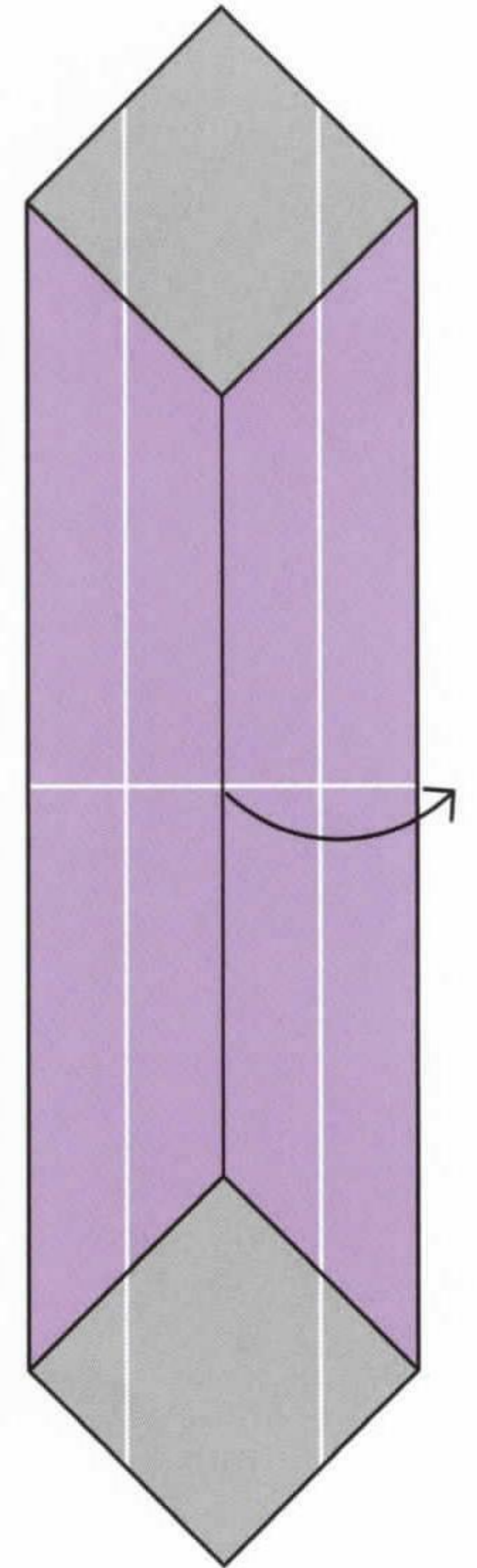

6. Pull out some paper

vanity table: part 1

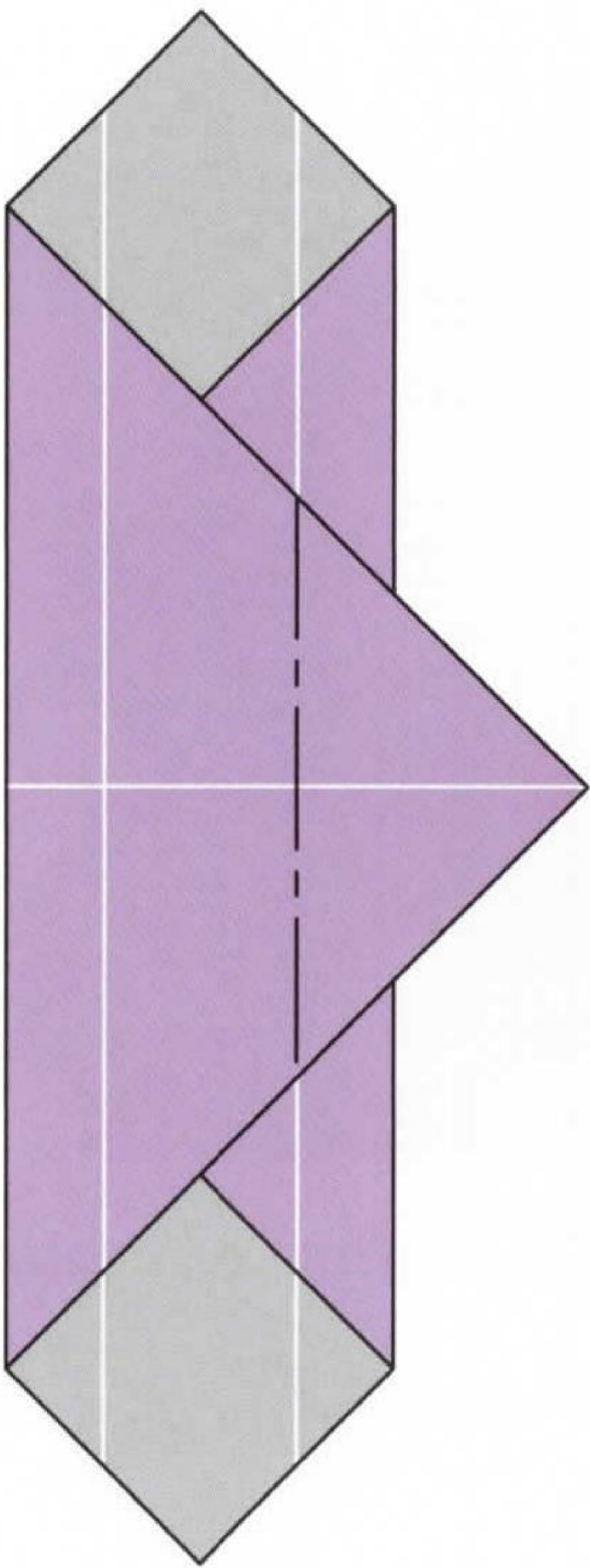

7. Mountain fold

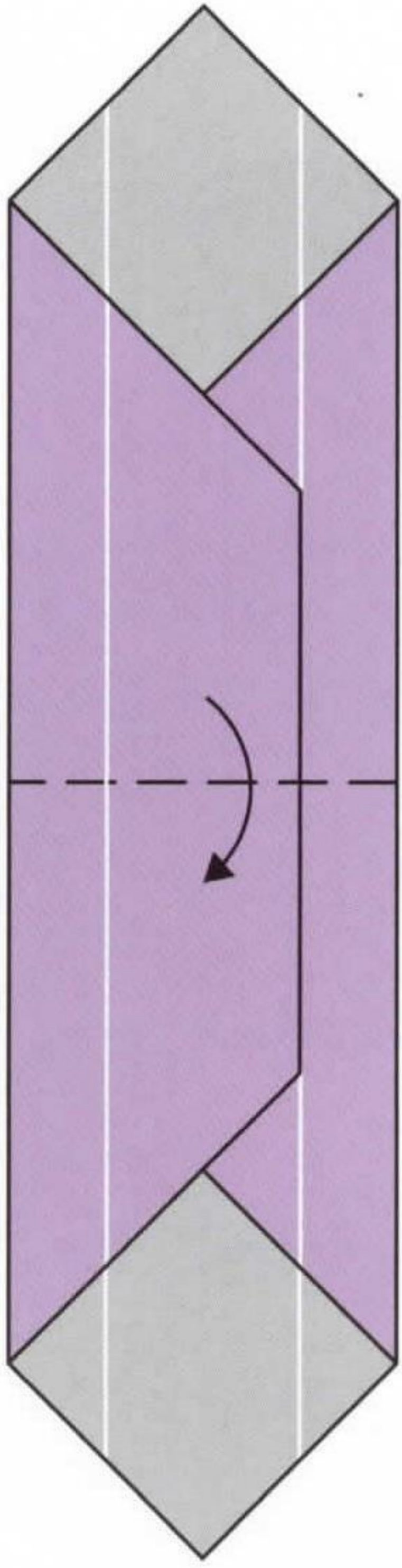

8. Valley fold

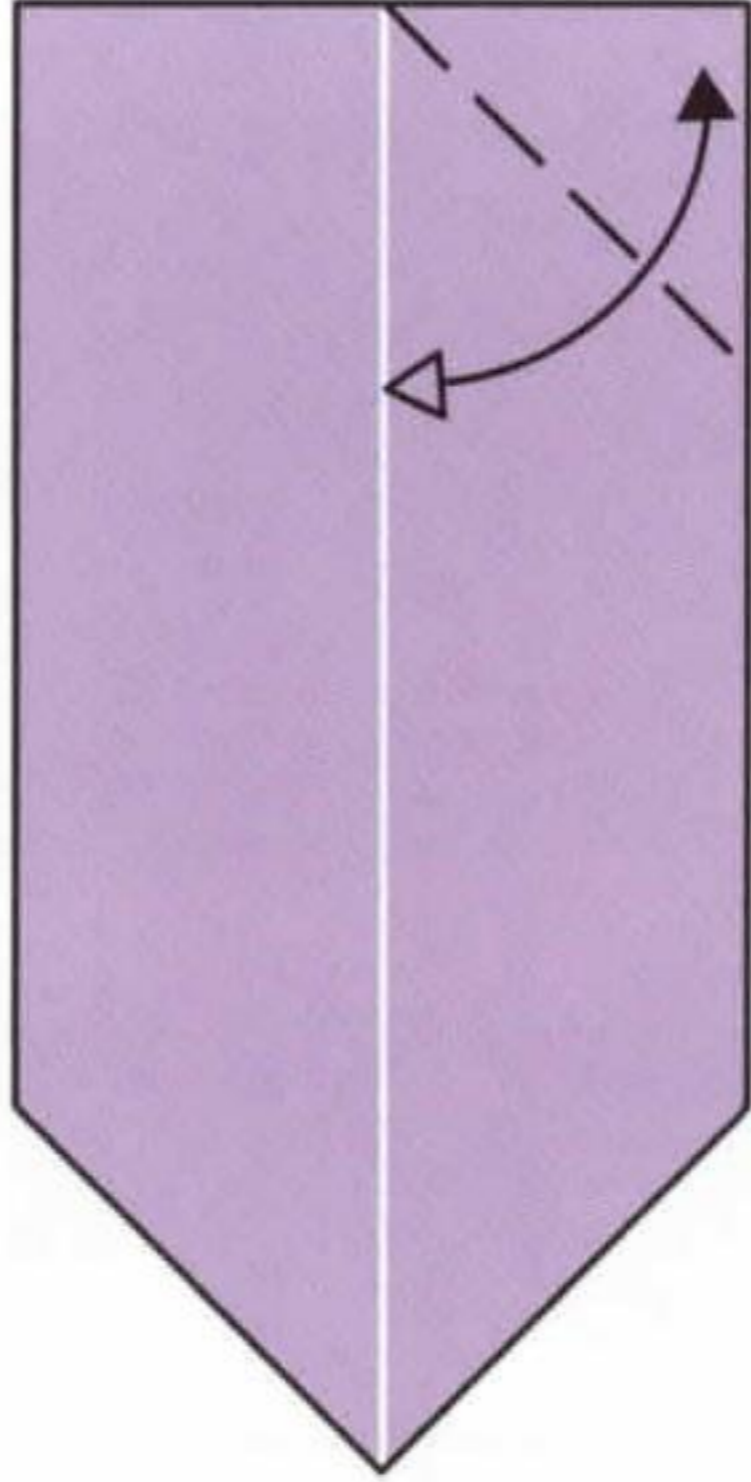

9. Fold and unfold

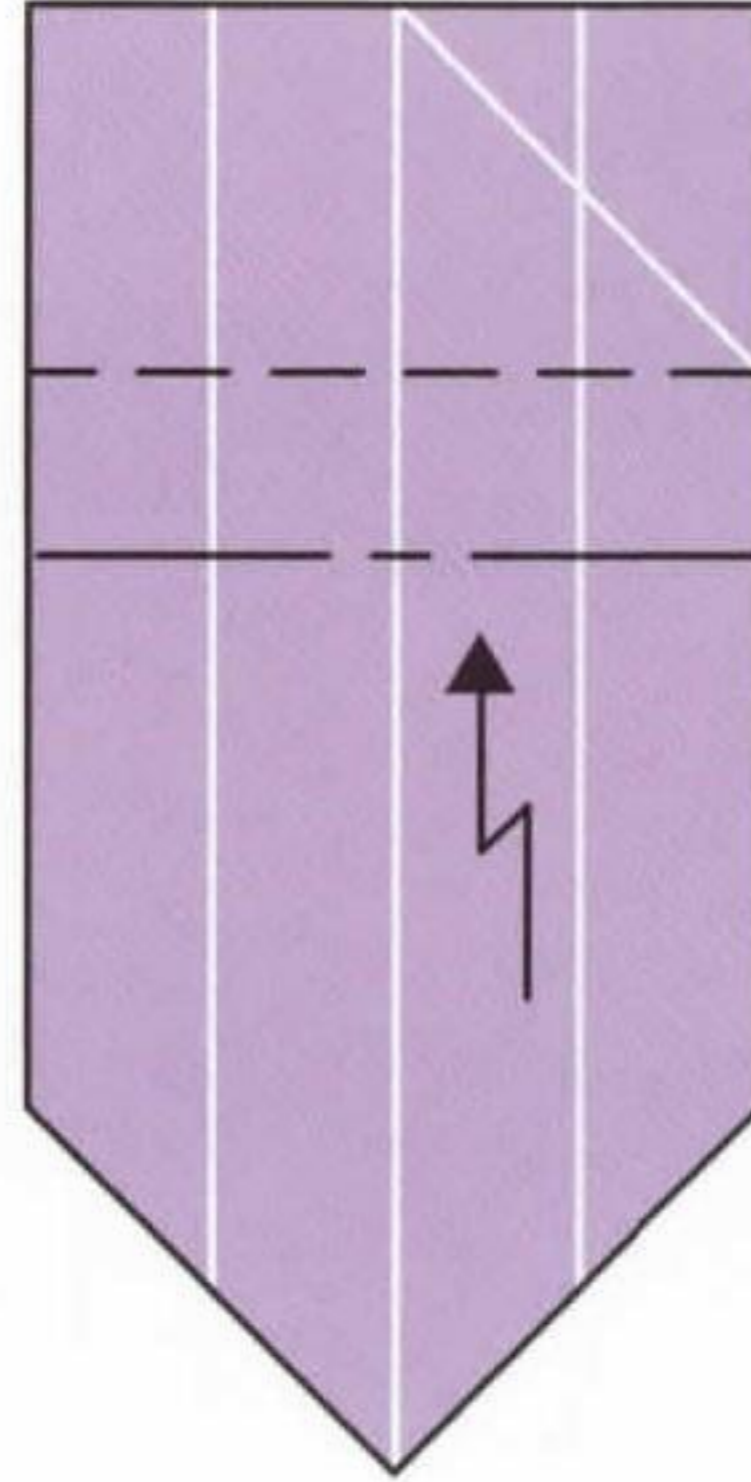

10. Pleat fold

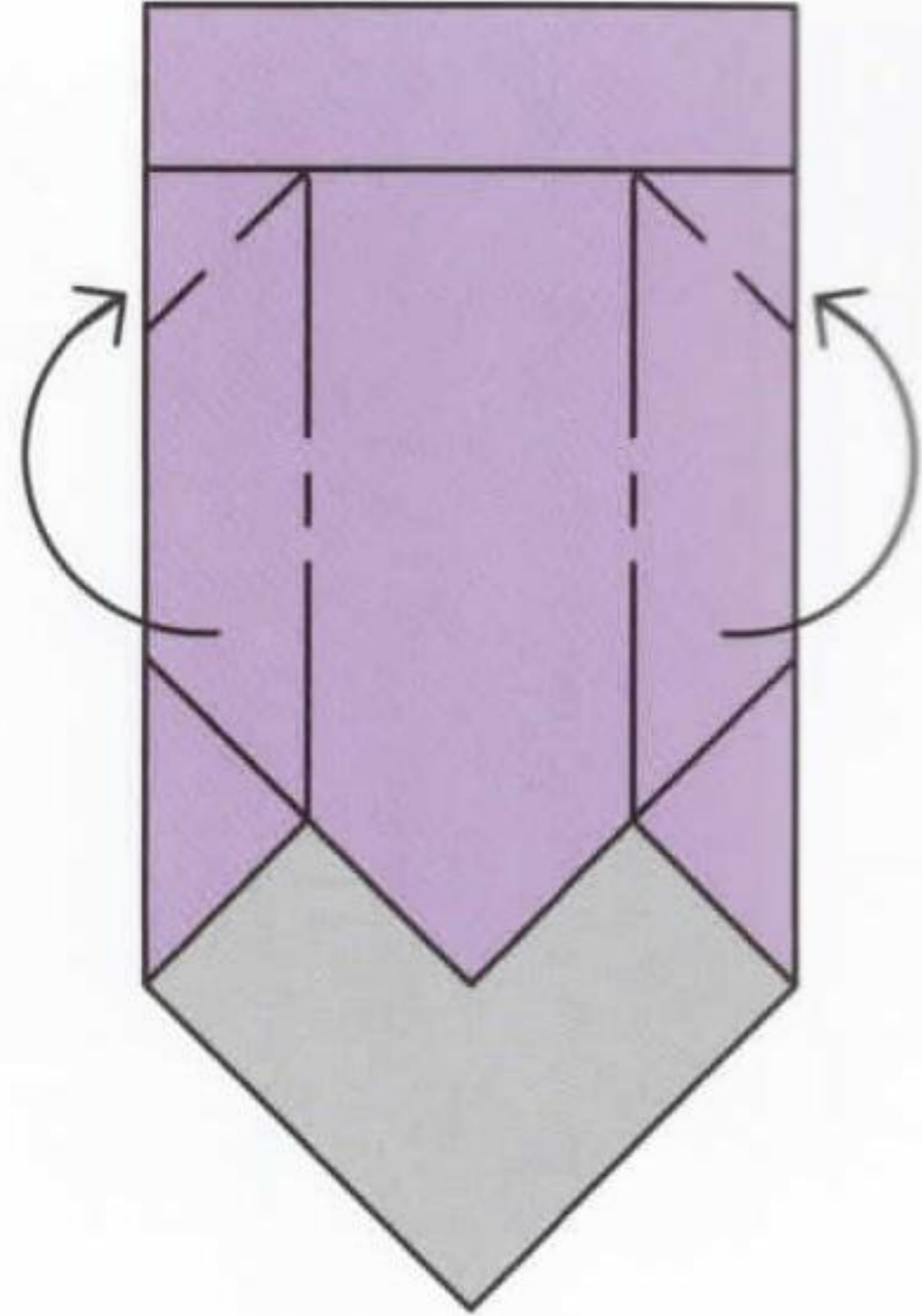

11. Crimp folds

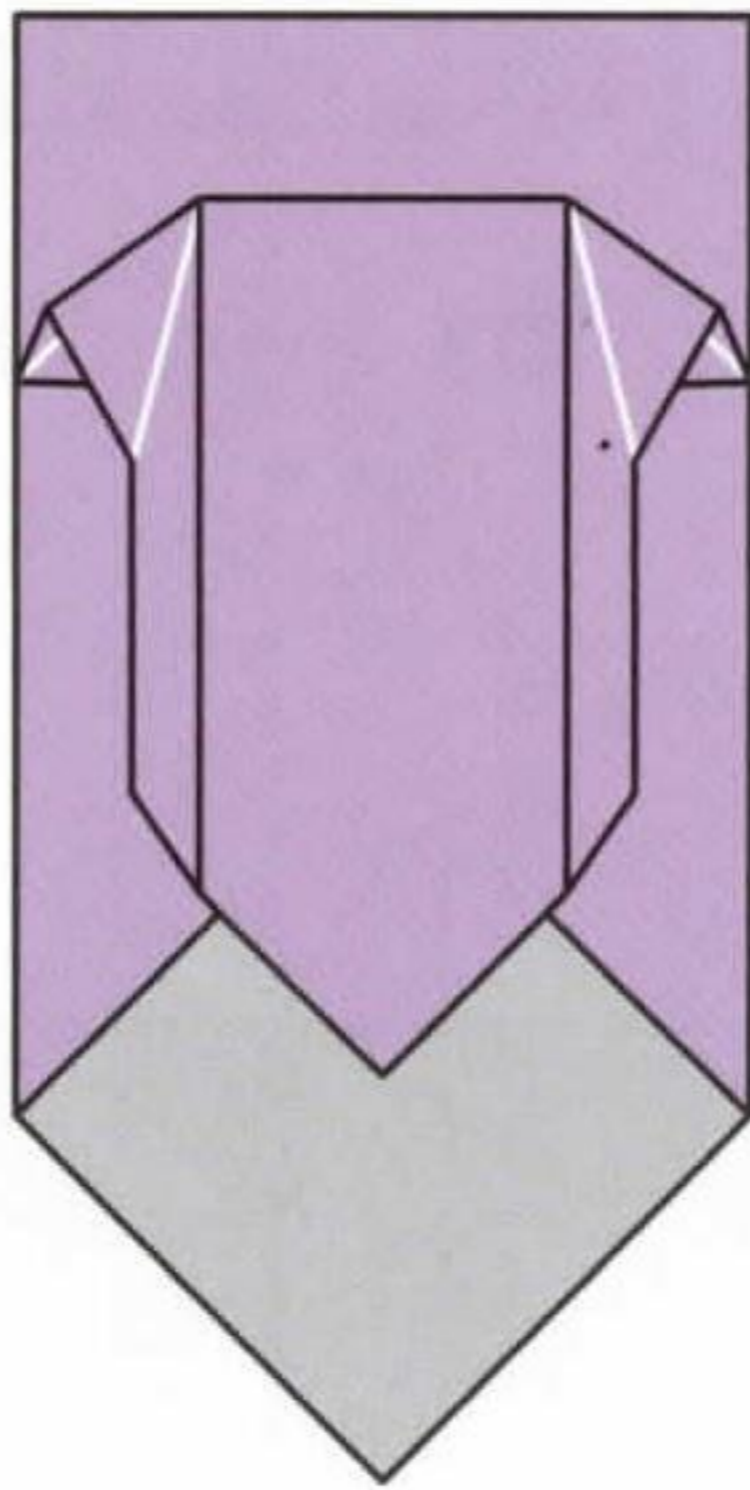

12. Before complete

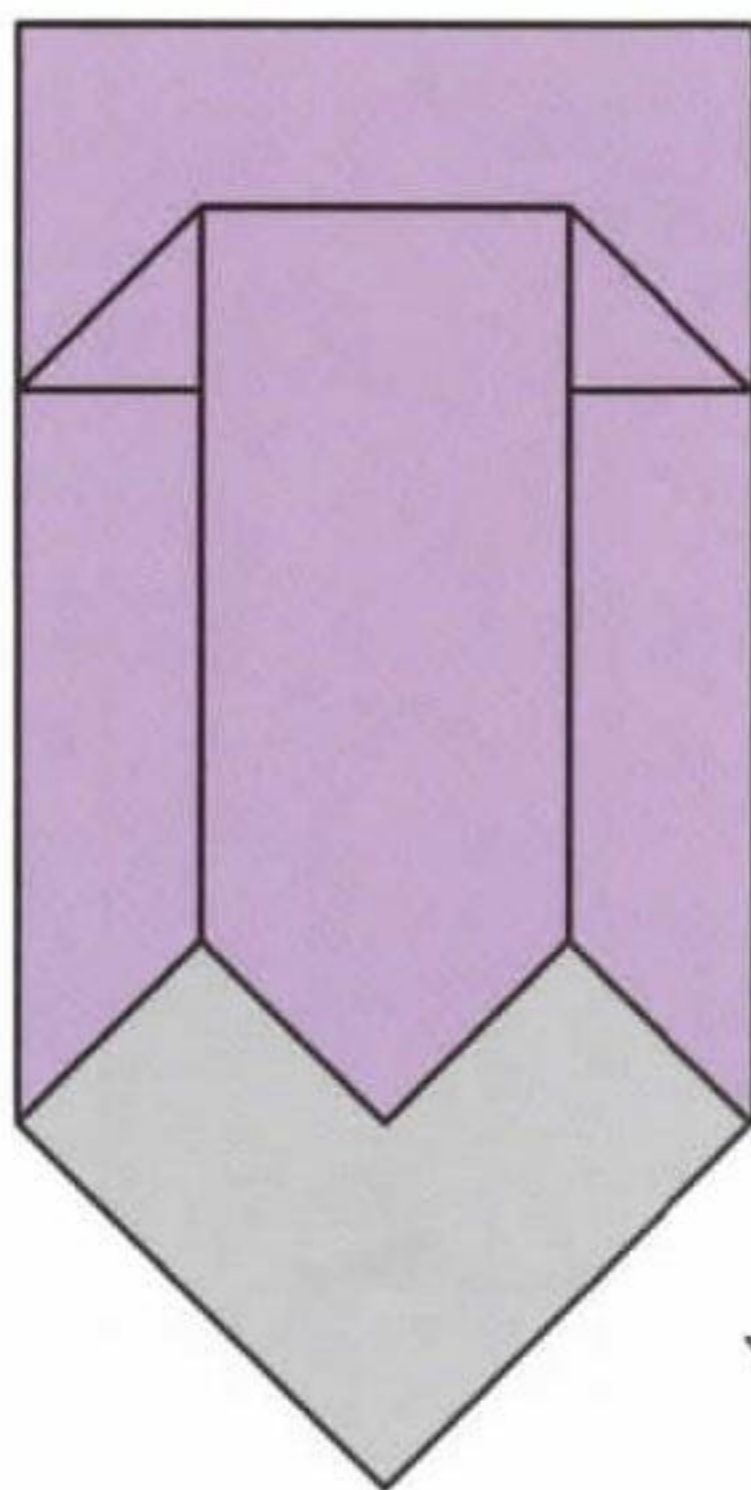

13. Turn over

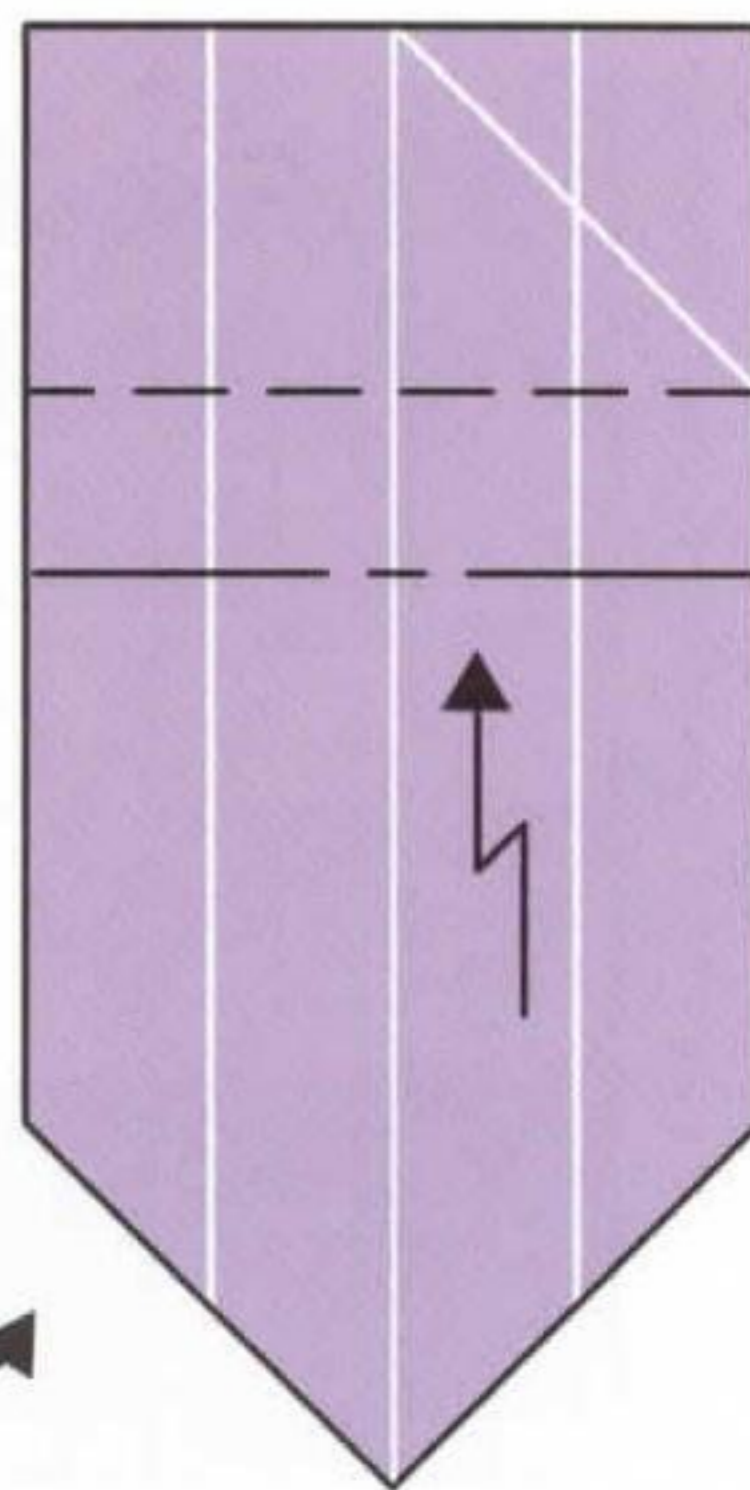

14. Pleat fold

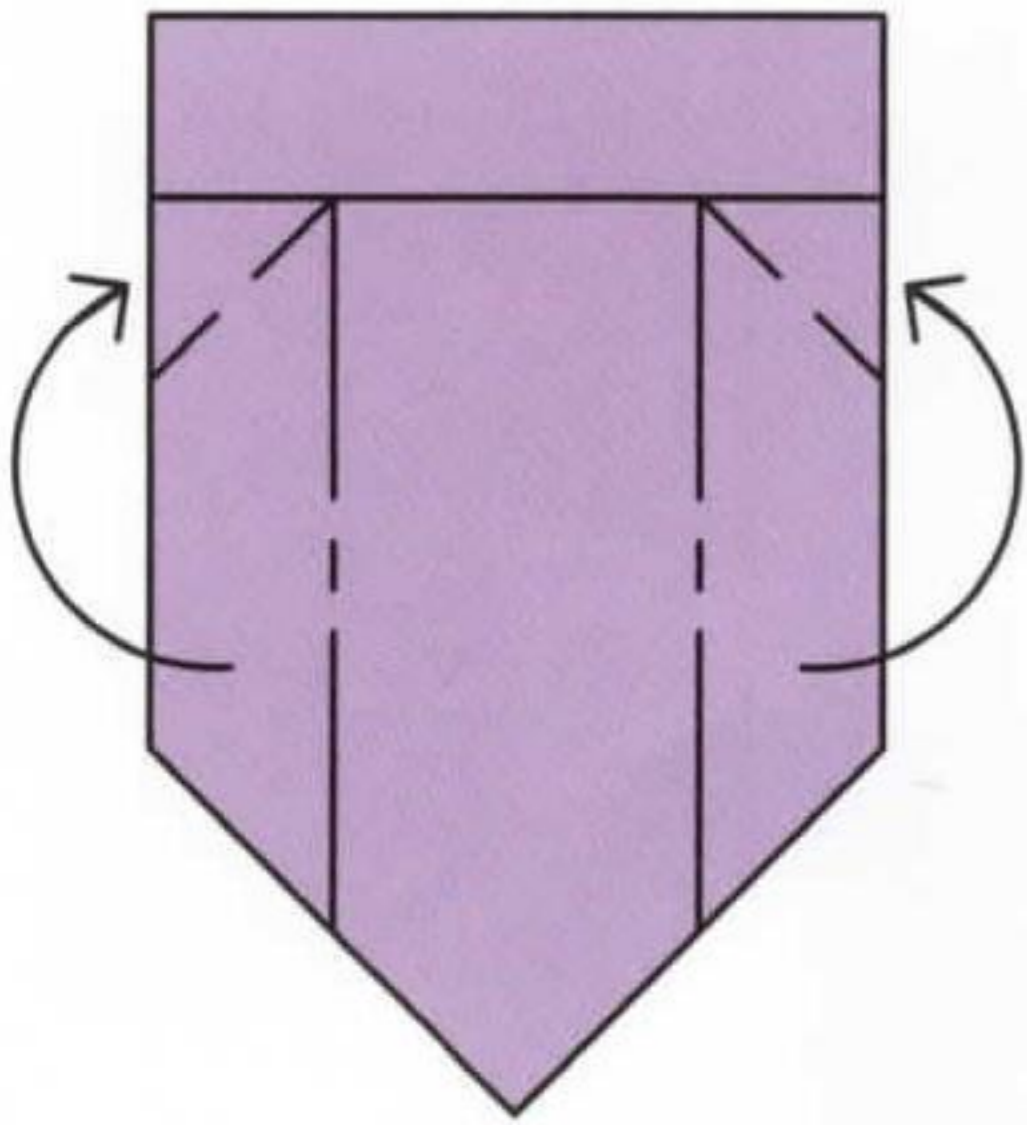

15. Crimp folds

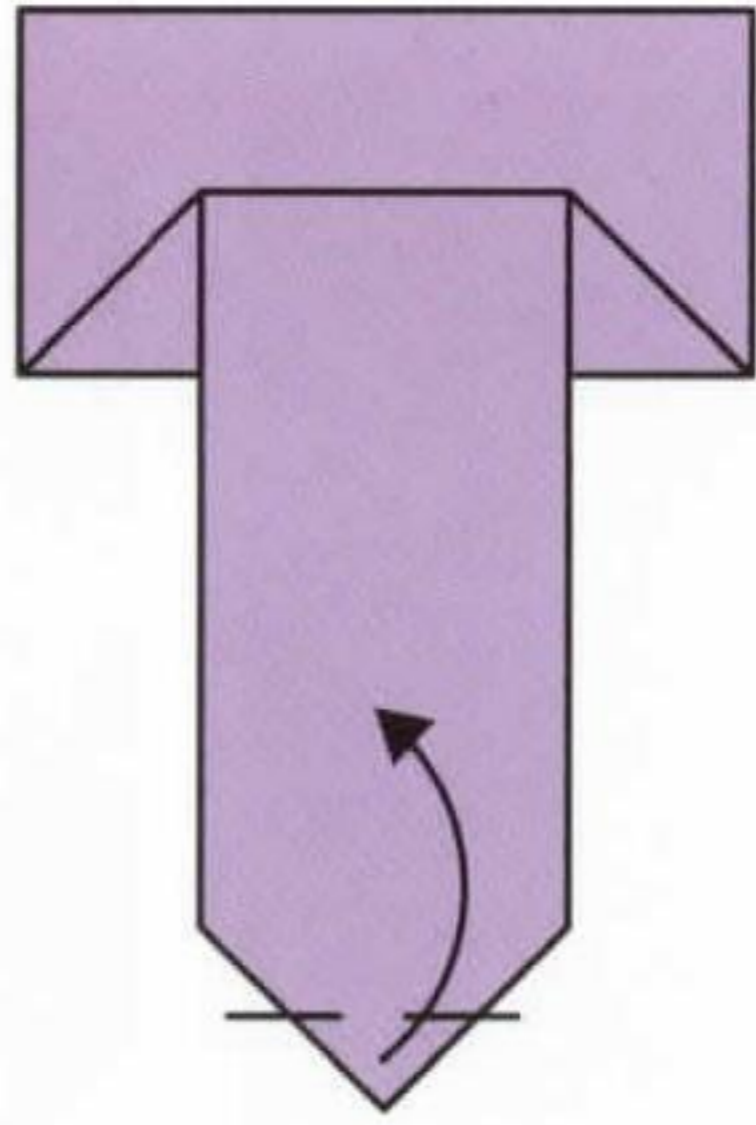

16. Valley fold

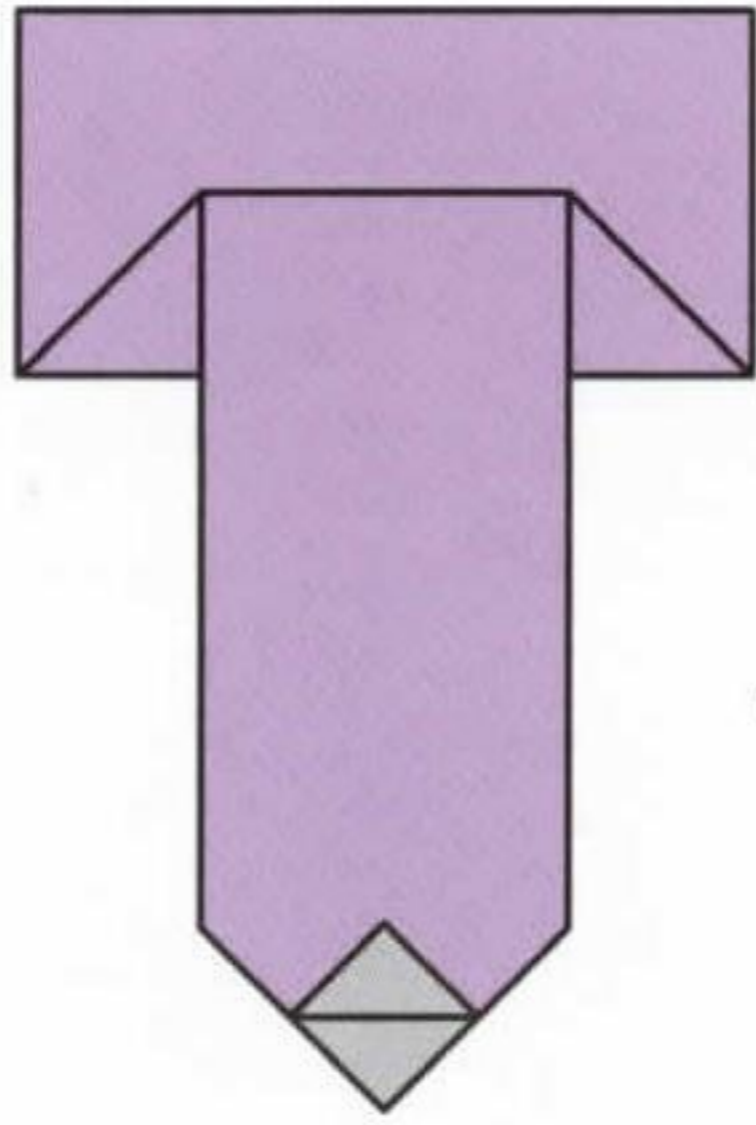

17. Turn over

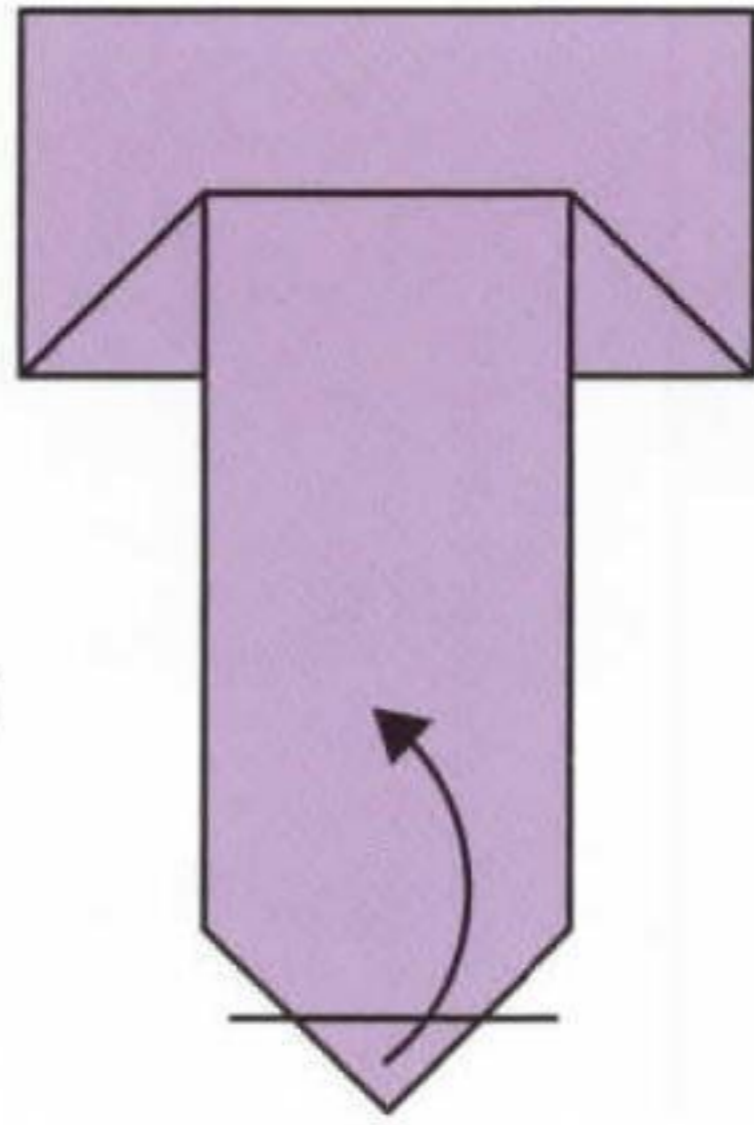

18. Valley fold

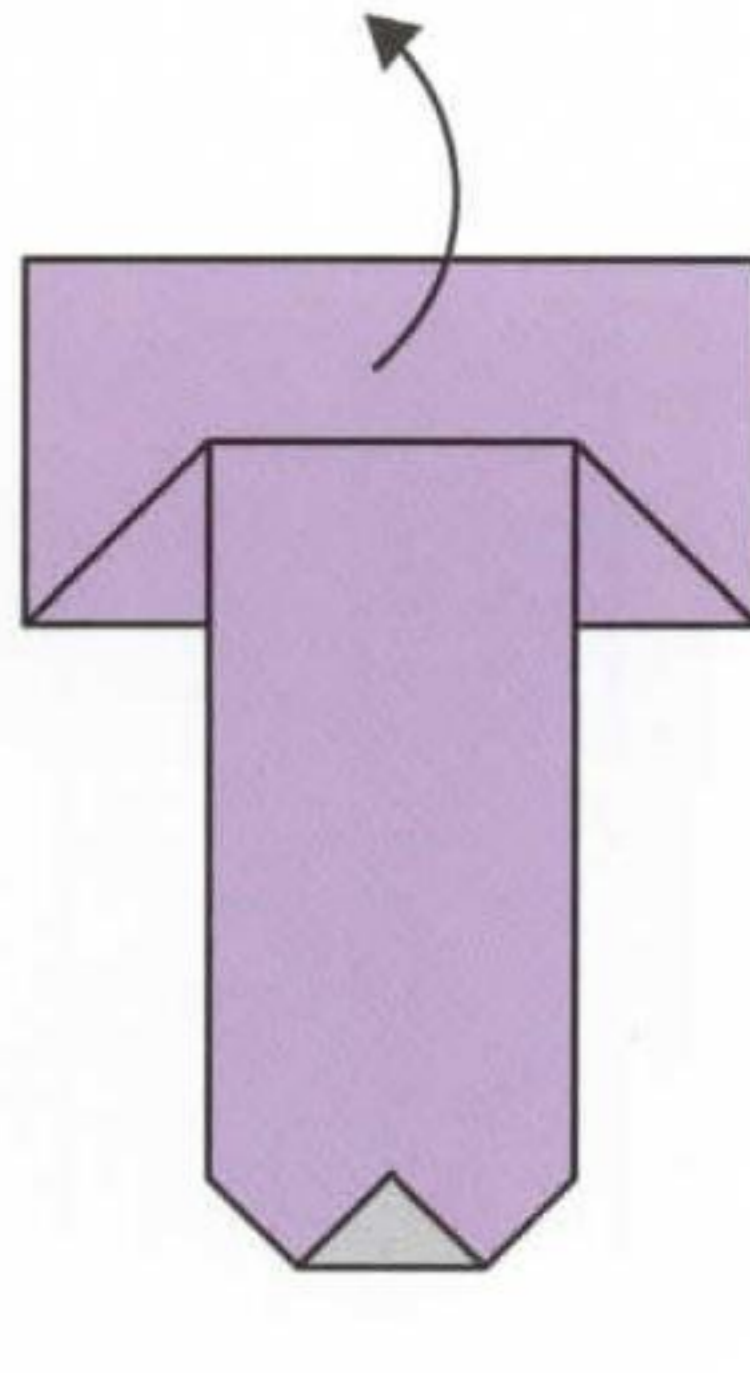

19. Valley fold

vanity table: part 1

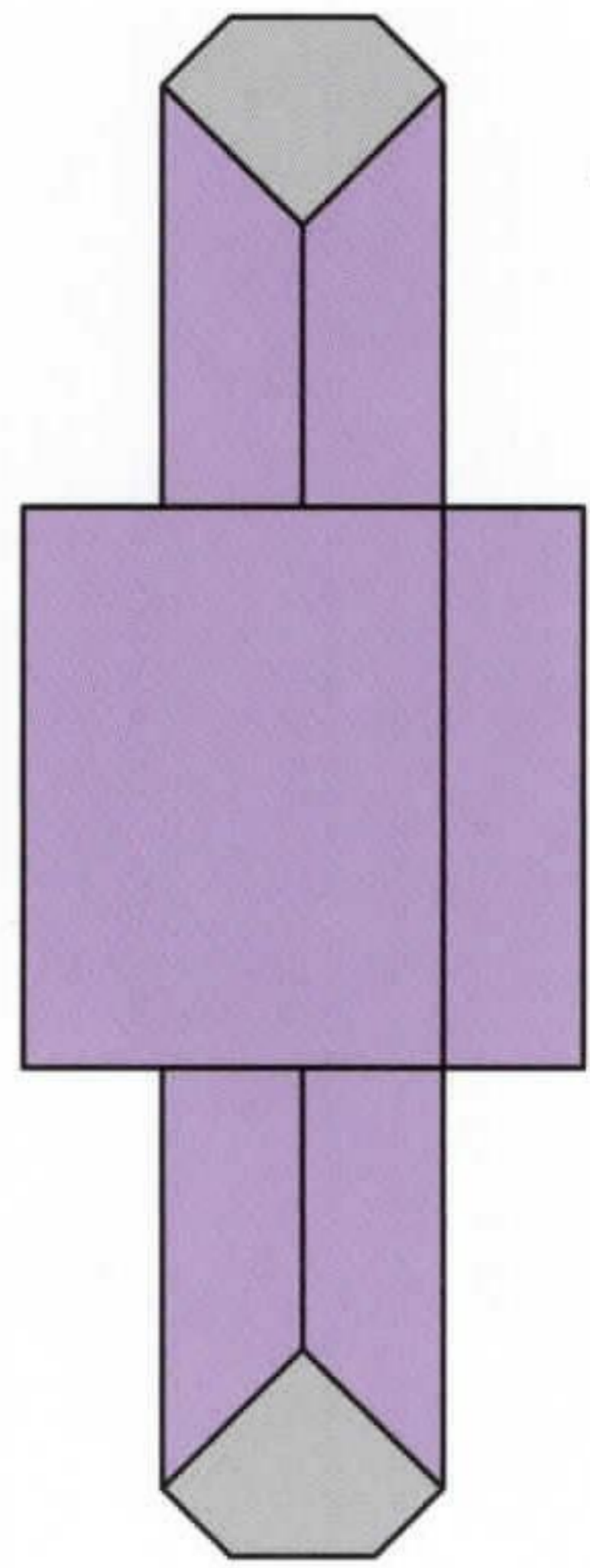

20. Rotate and turn over

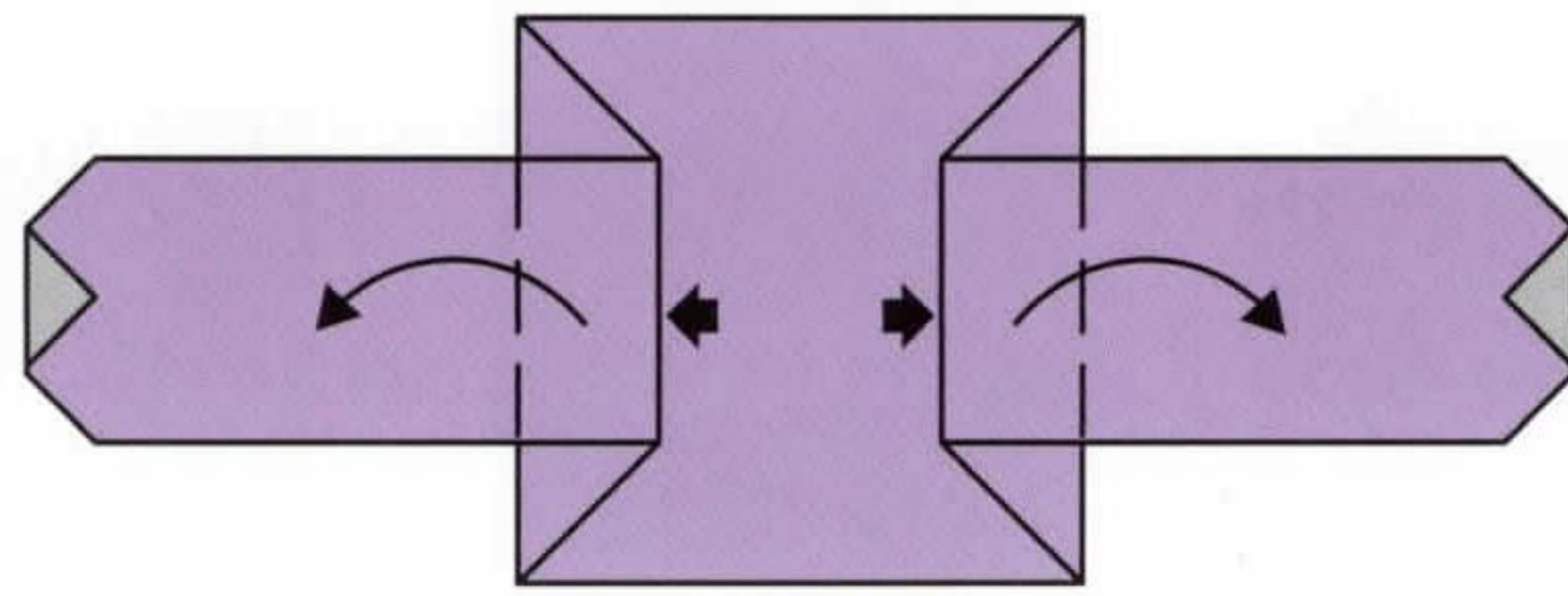

21. Add glue and Valley folds

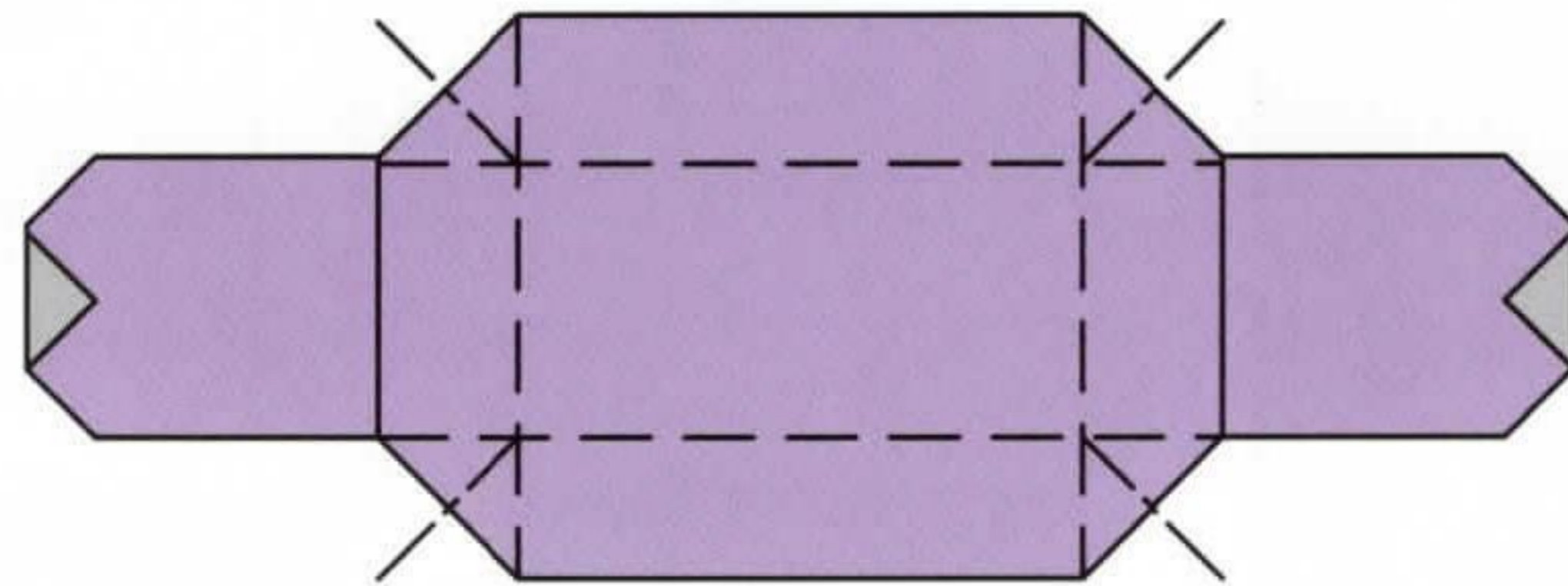

22. Valley folds and Crimp folds

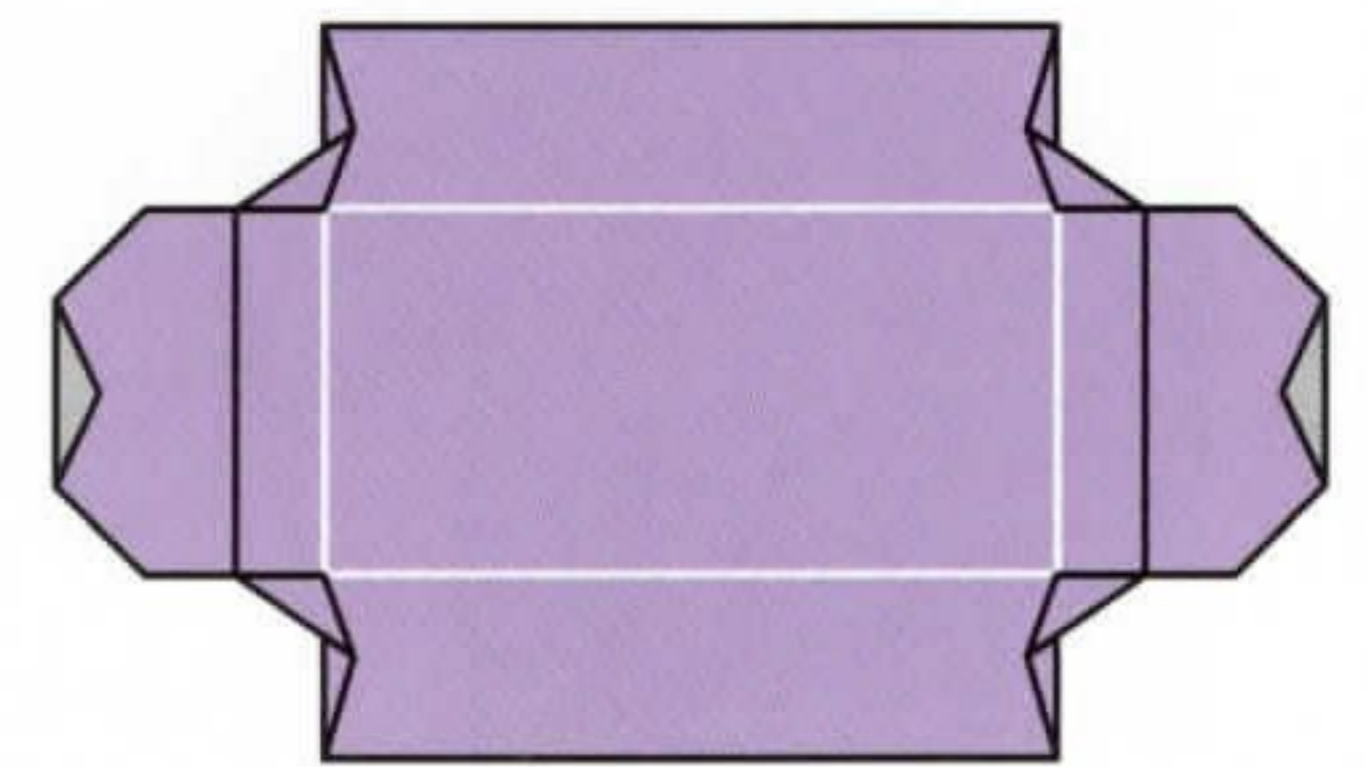

23. Before complete



24. Scale-up



25. Add glue and folds



26. Rotate

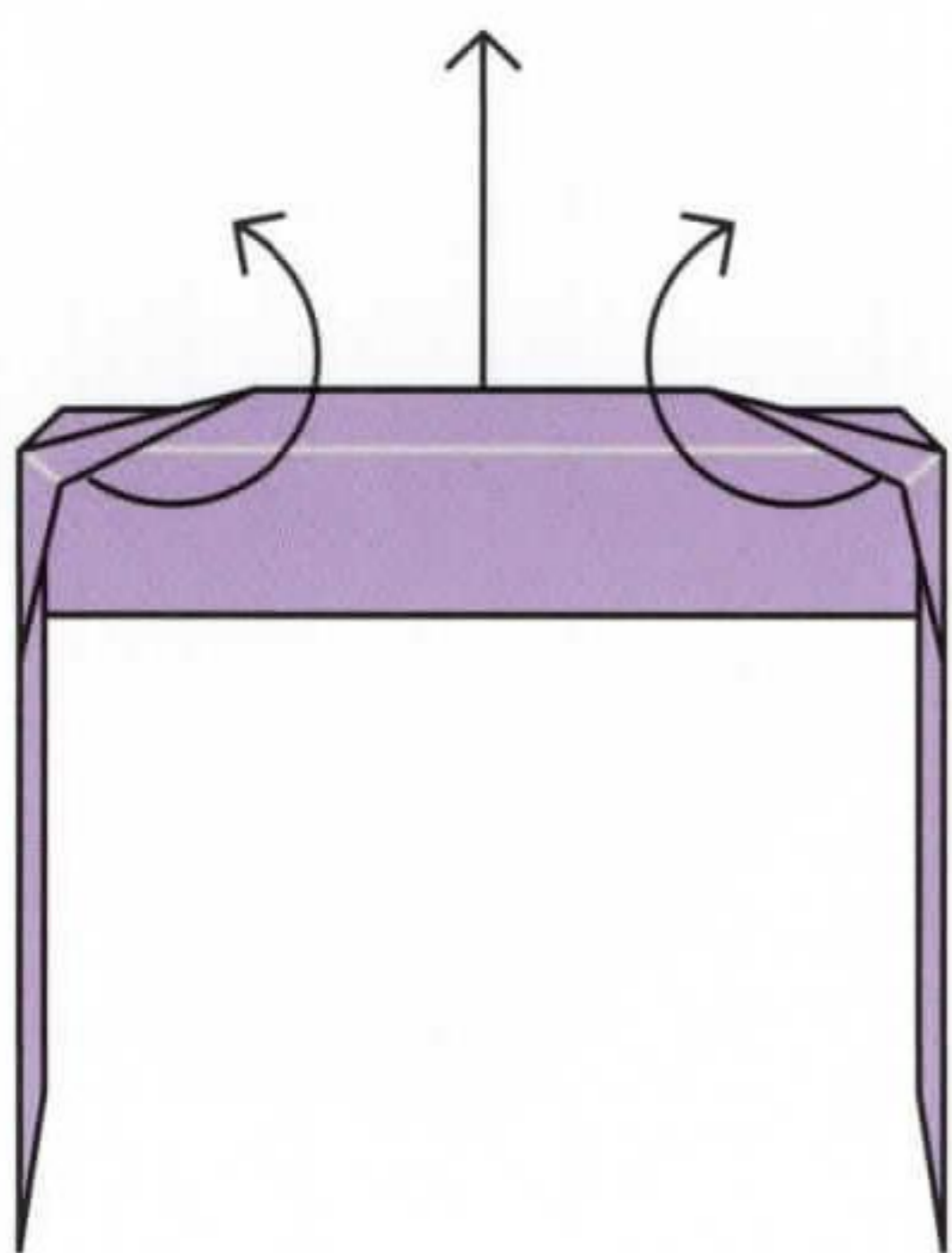
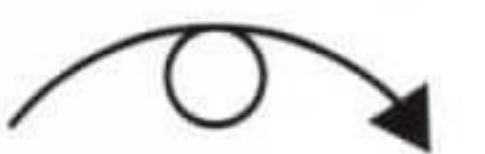

27. Pull and fold

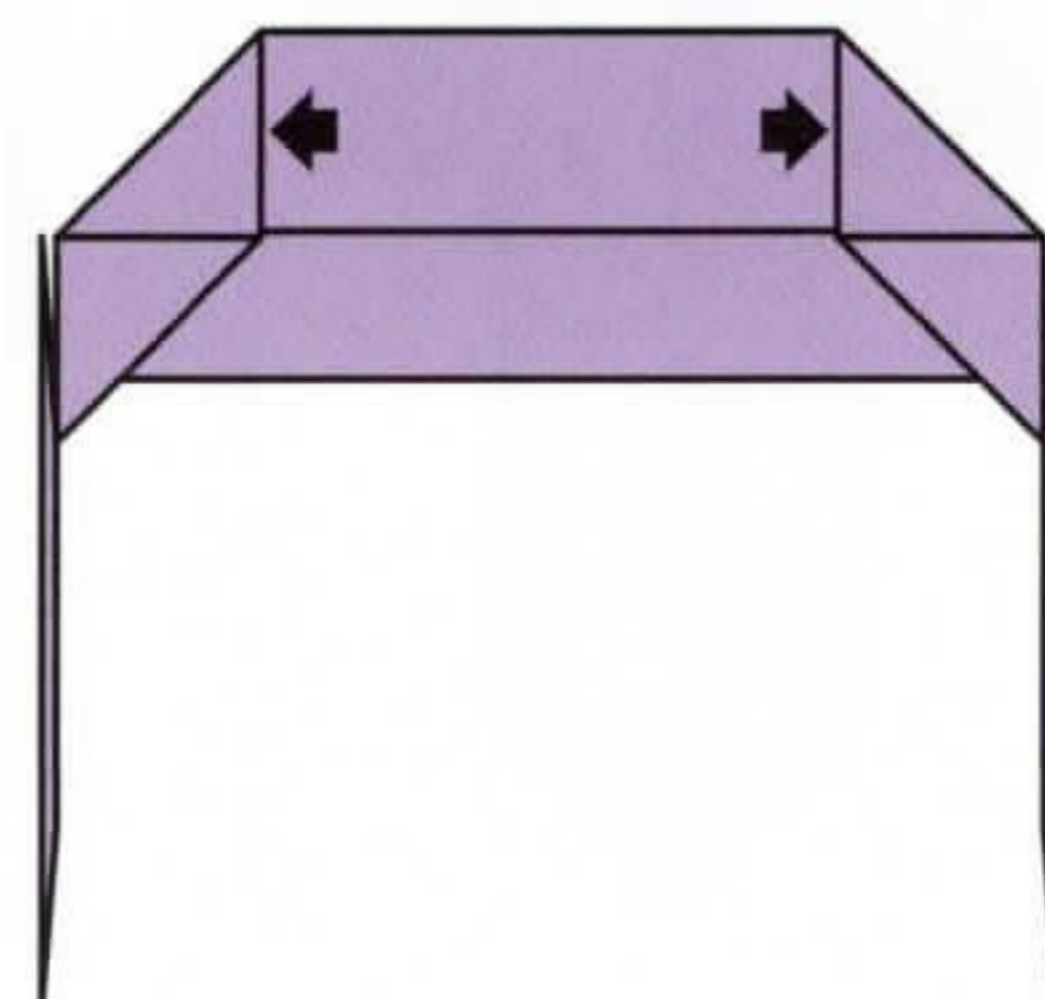

28. Apply glue and rotate

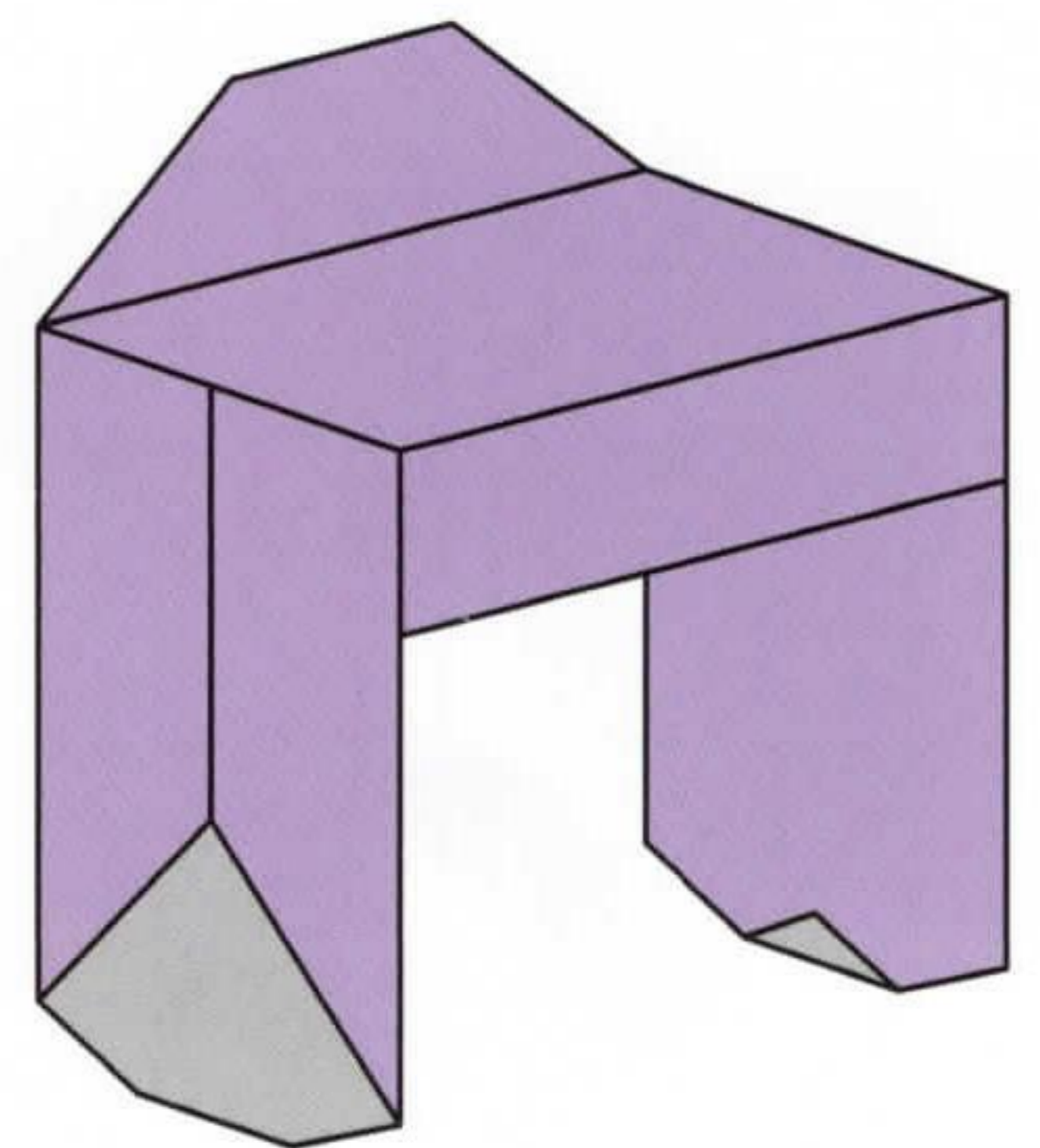

29. Completed PART 1

vanity table: part 2

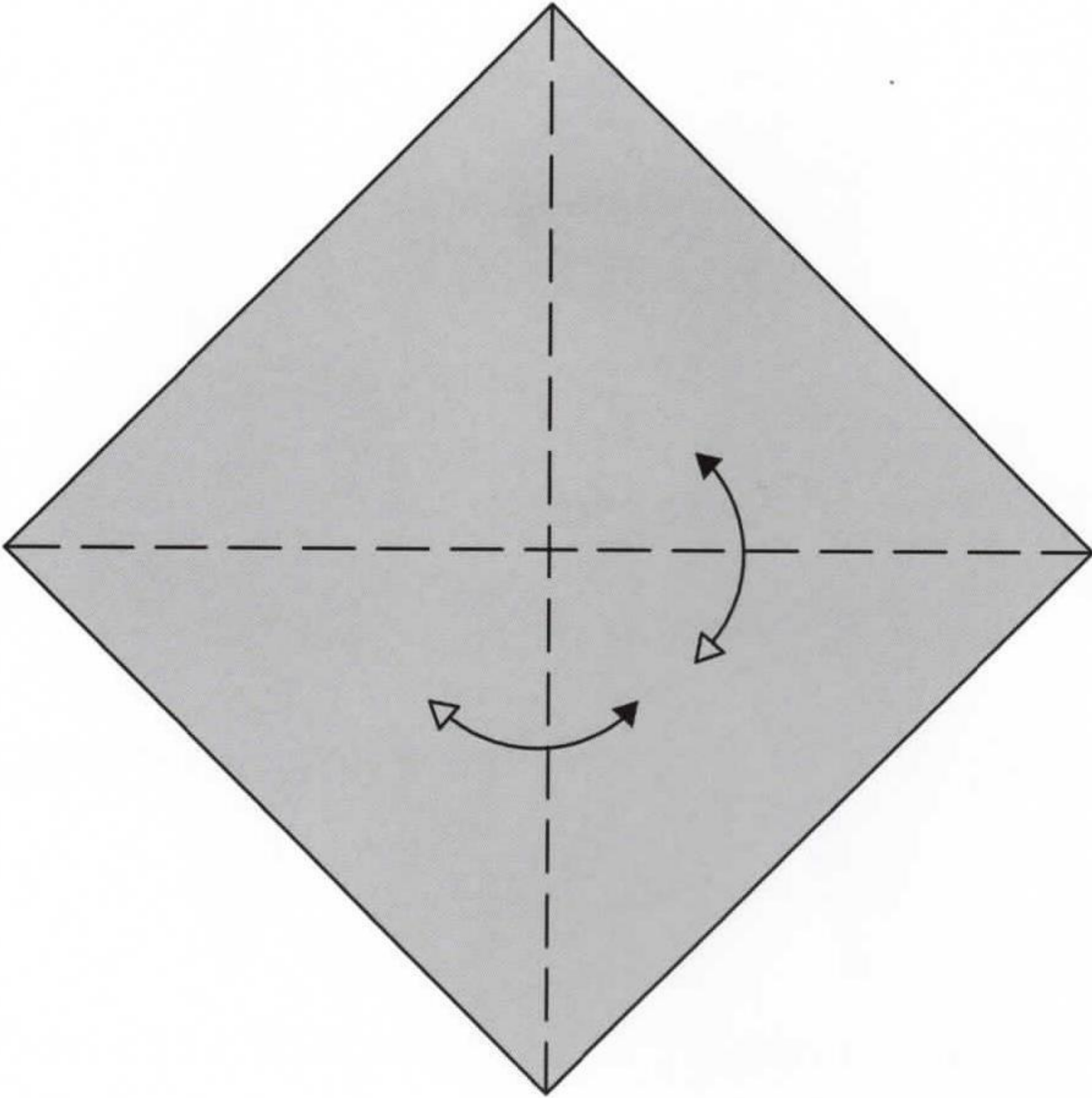

1. Valley folds and unfold

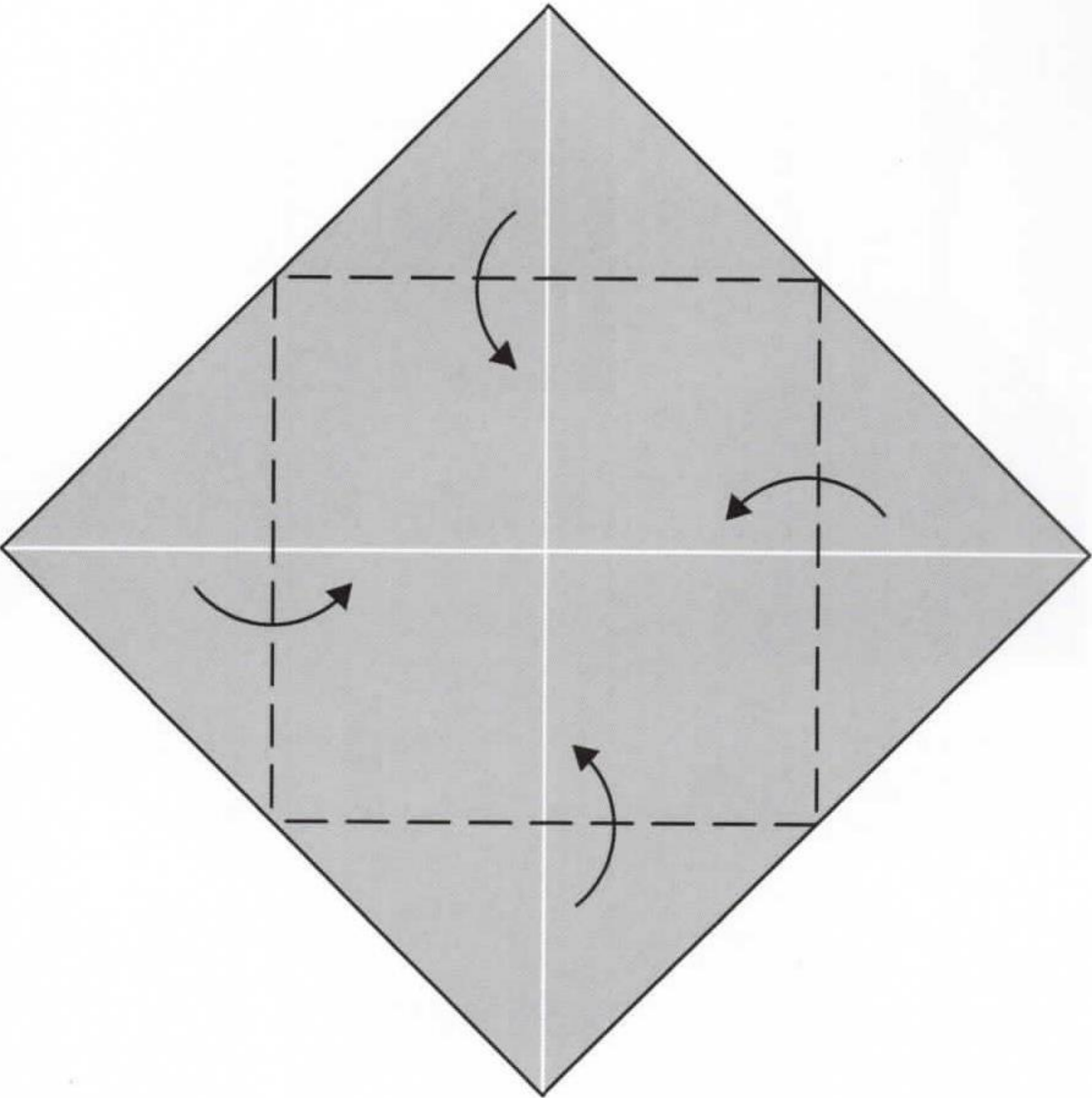

2. Valley folds

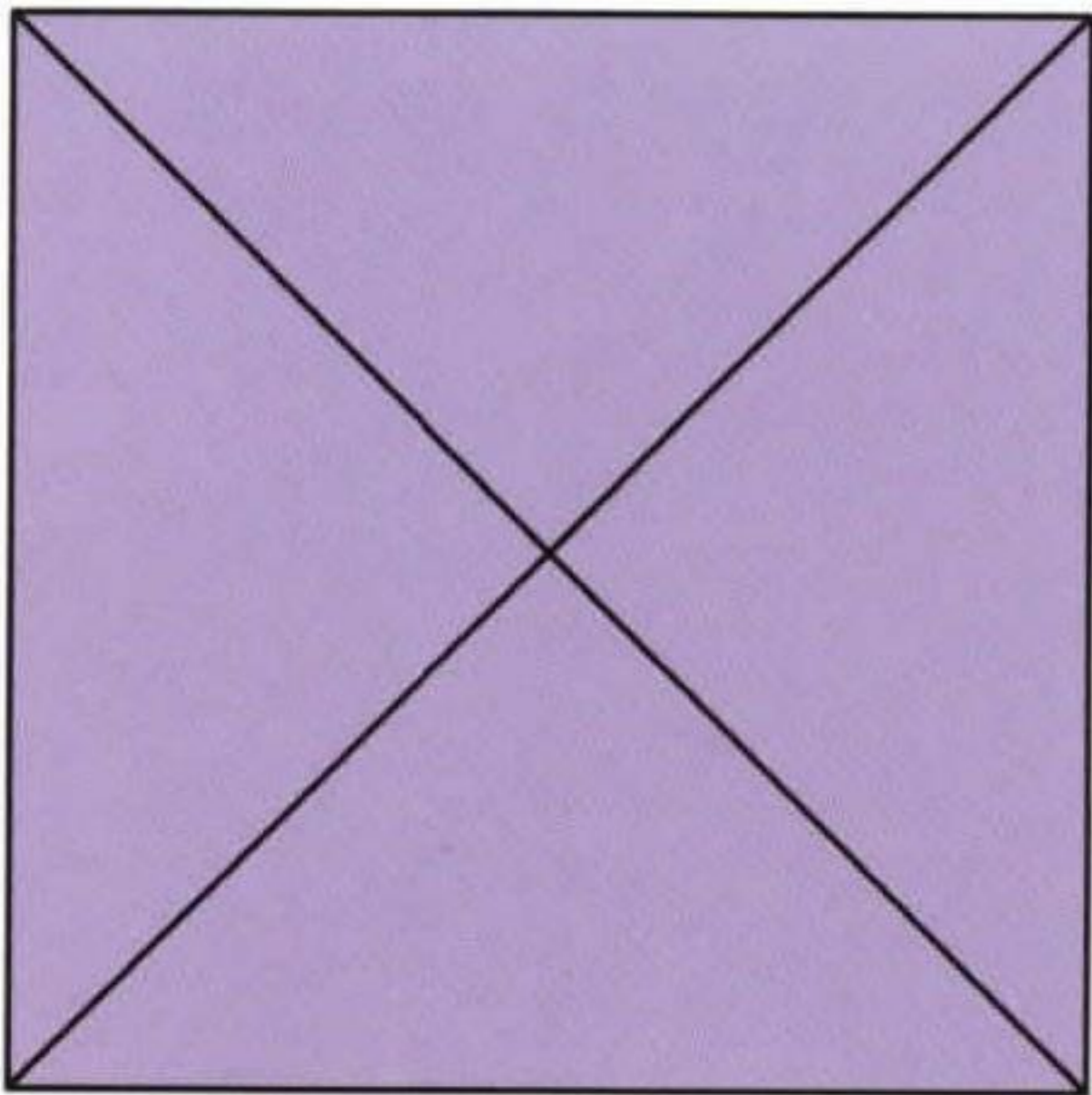

3. Scale-up

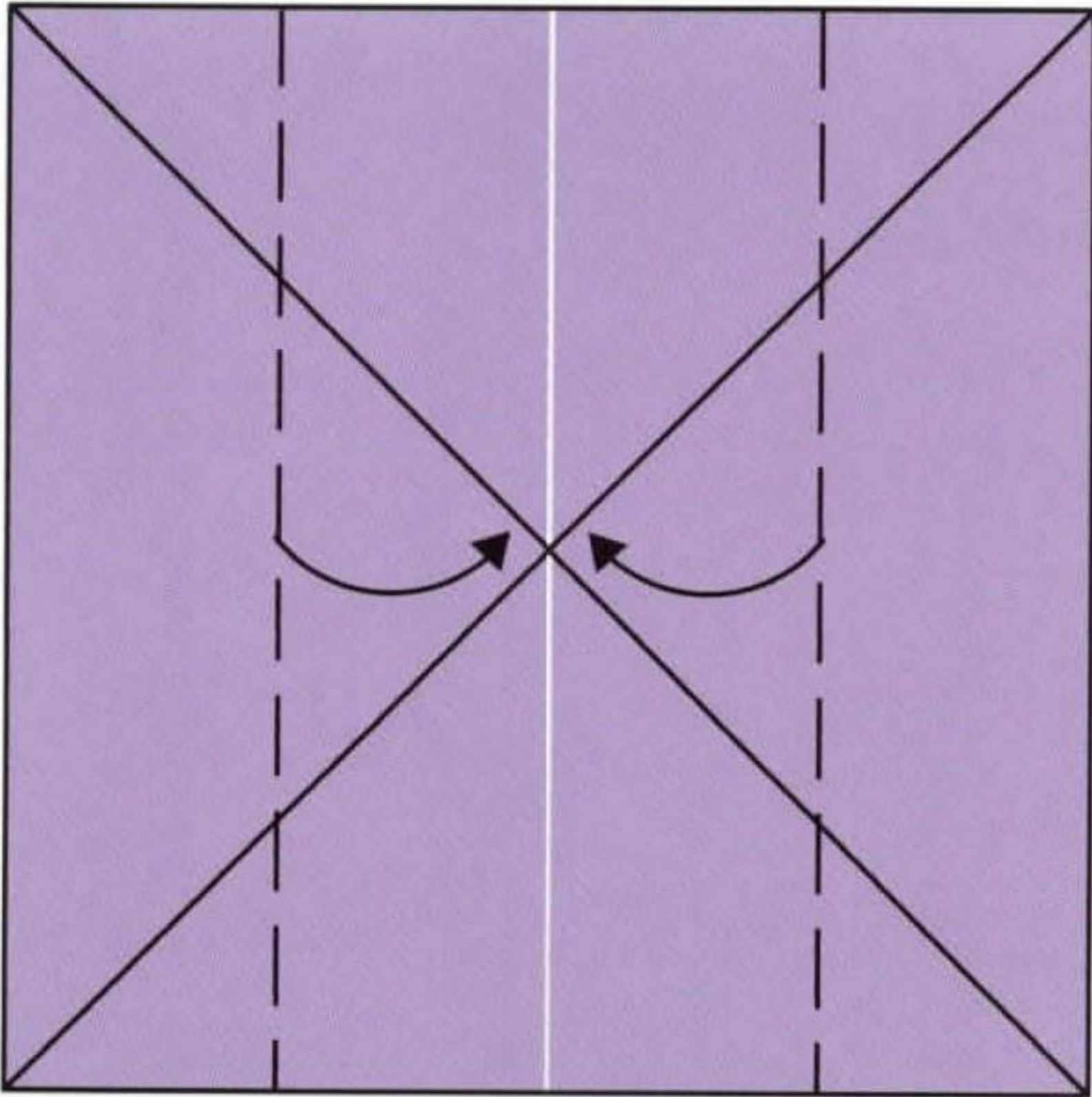

4. Valley folds

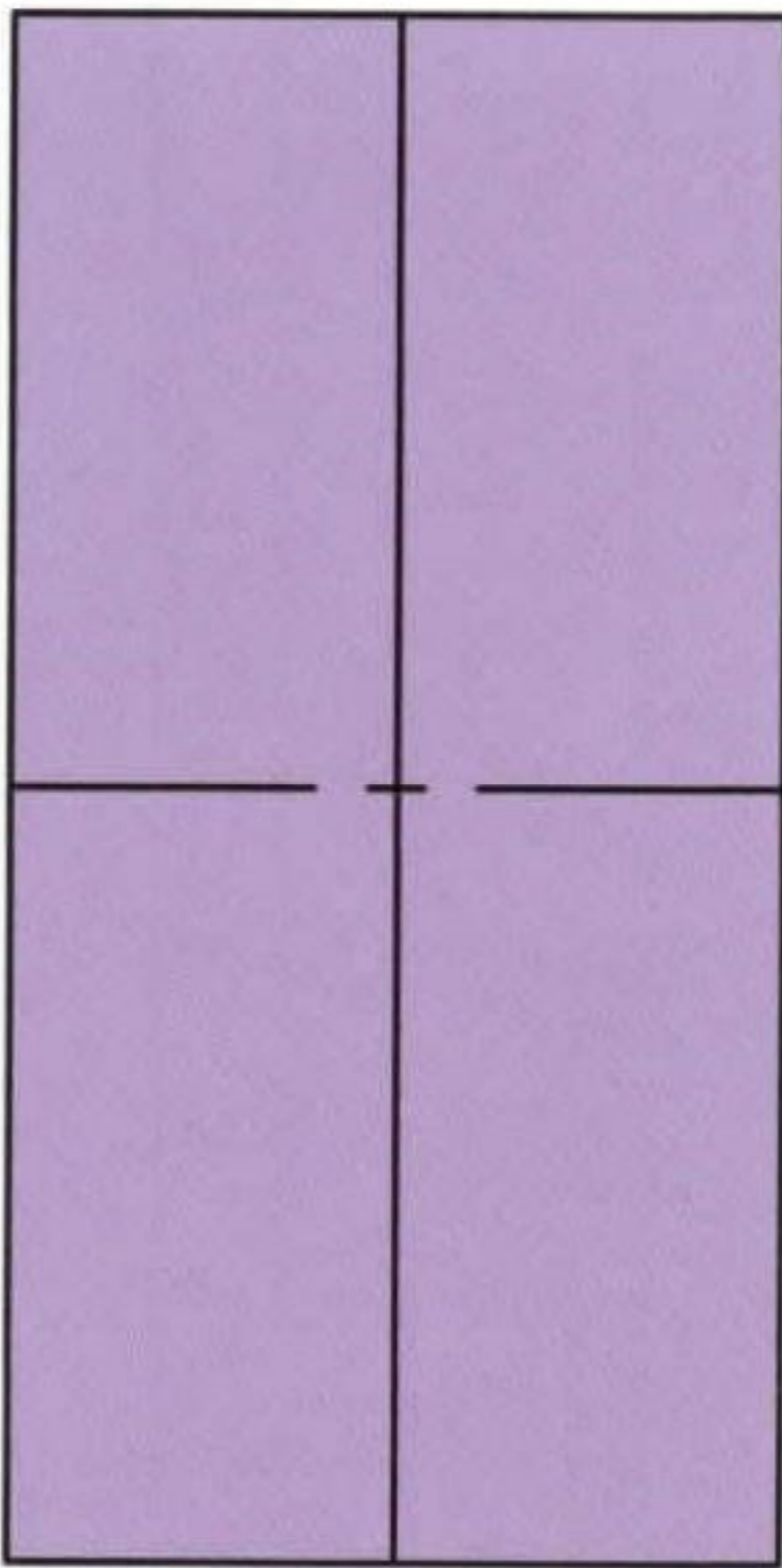

5. Mountain fold

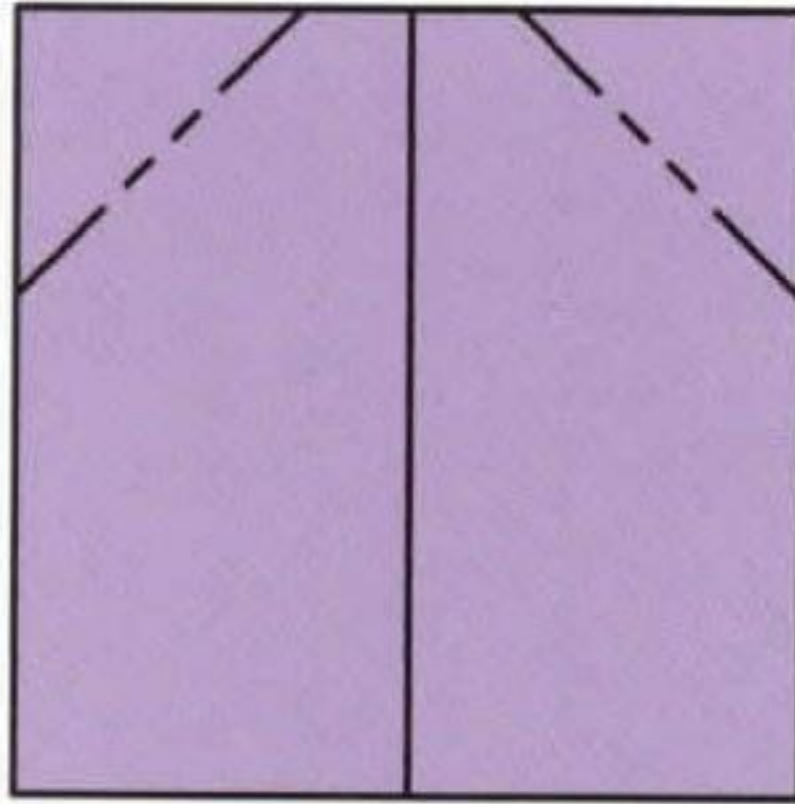

6. Inside reverse folds

vanity table: part 2

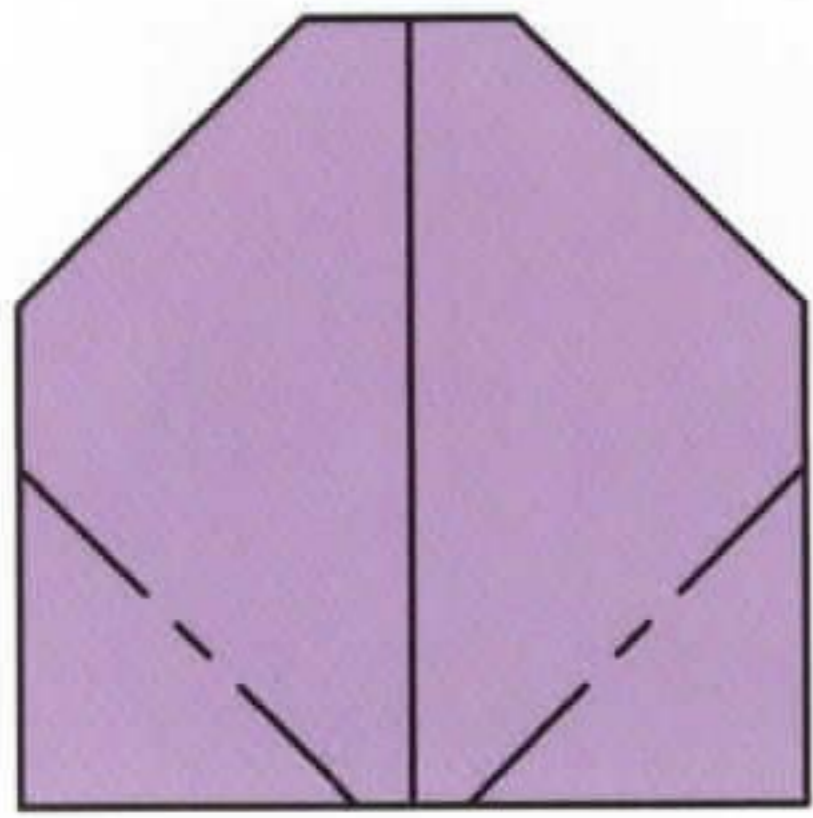

7. Mountain folds

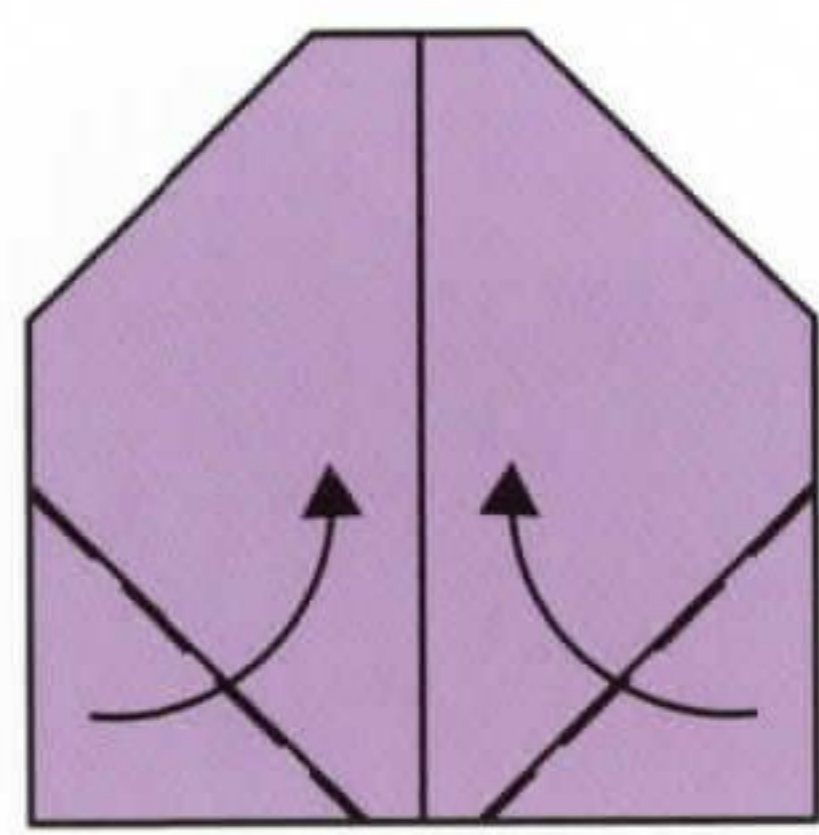

8. Valley folds

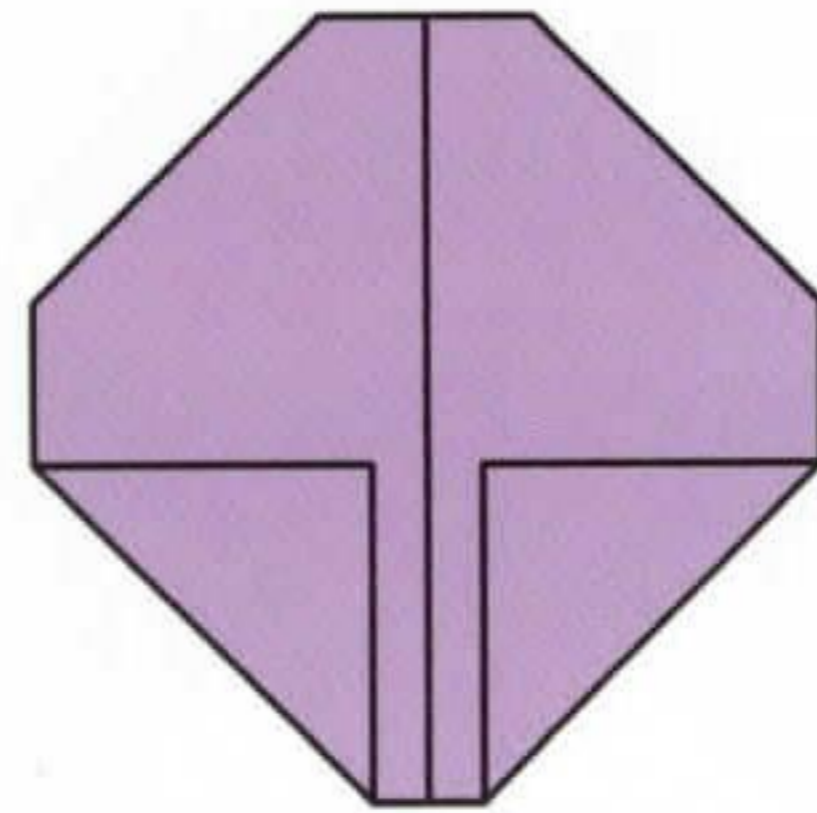

9. Hide behind

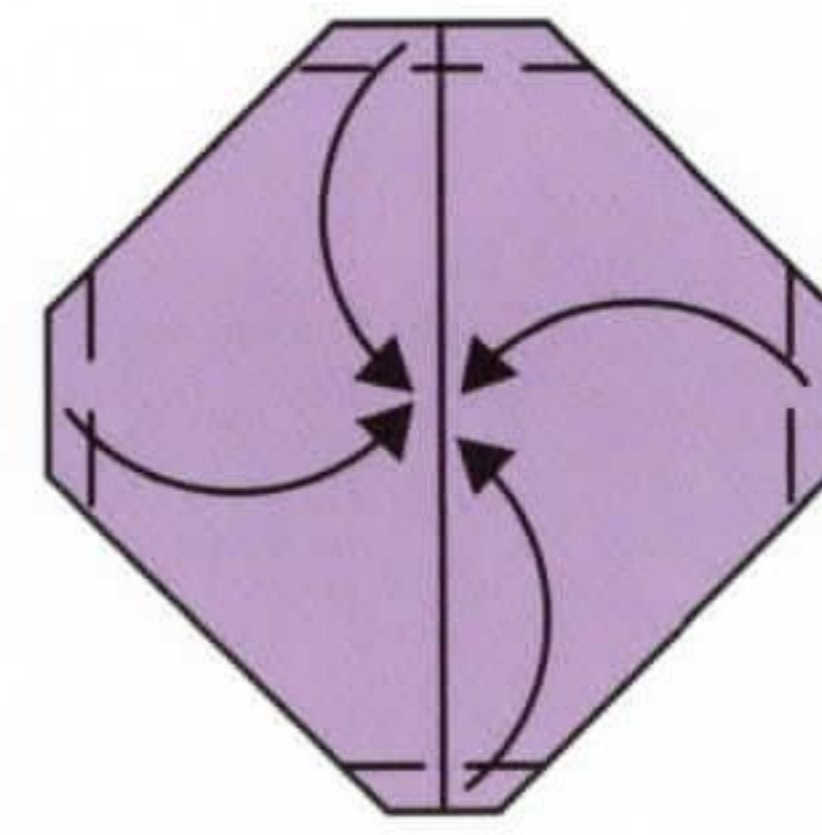

10. Valley folds

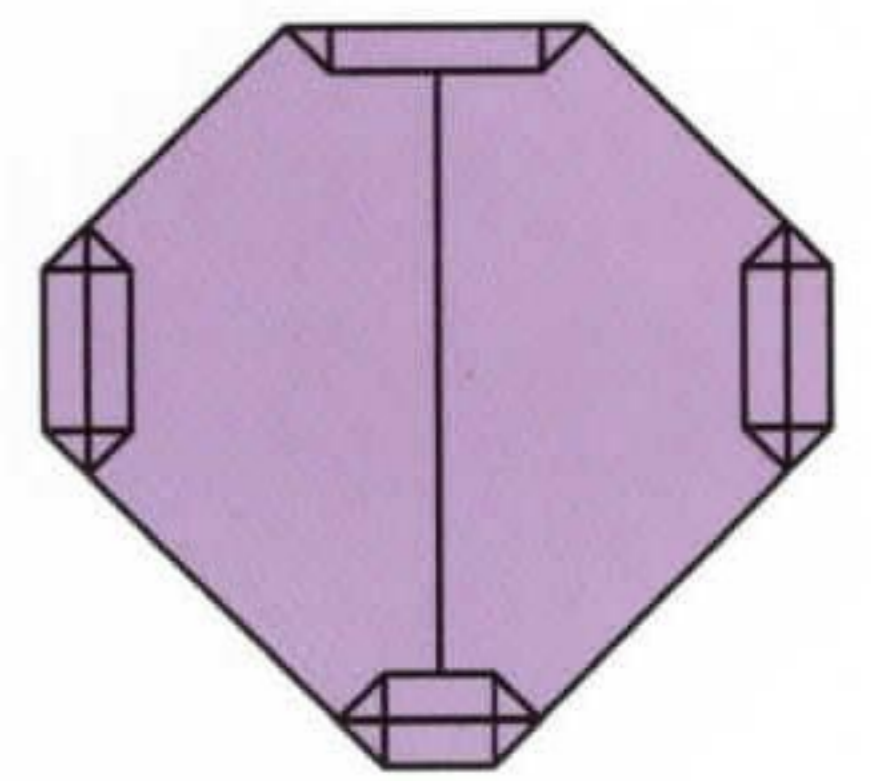

11. Completed PART 2

ASSEMBLY

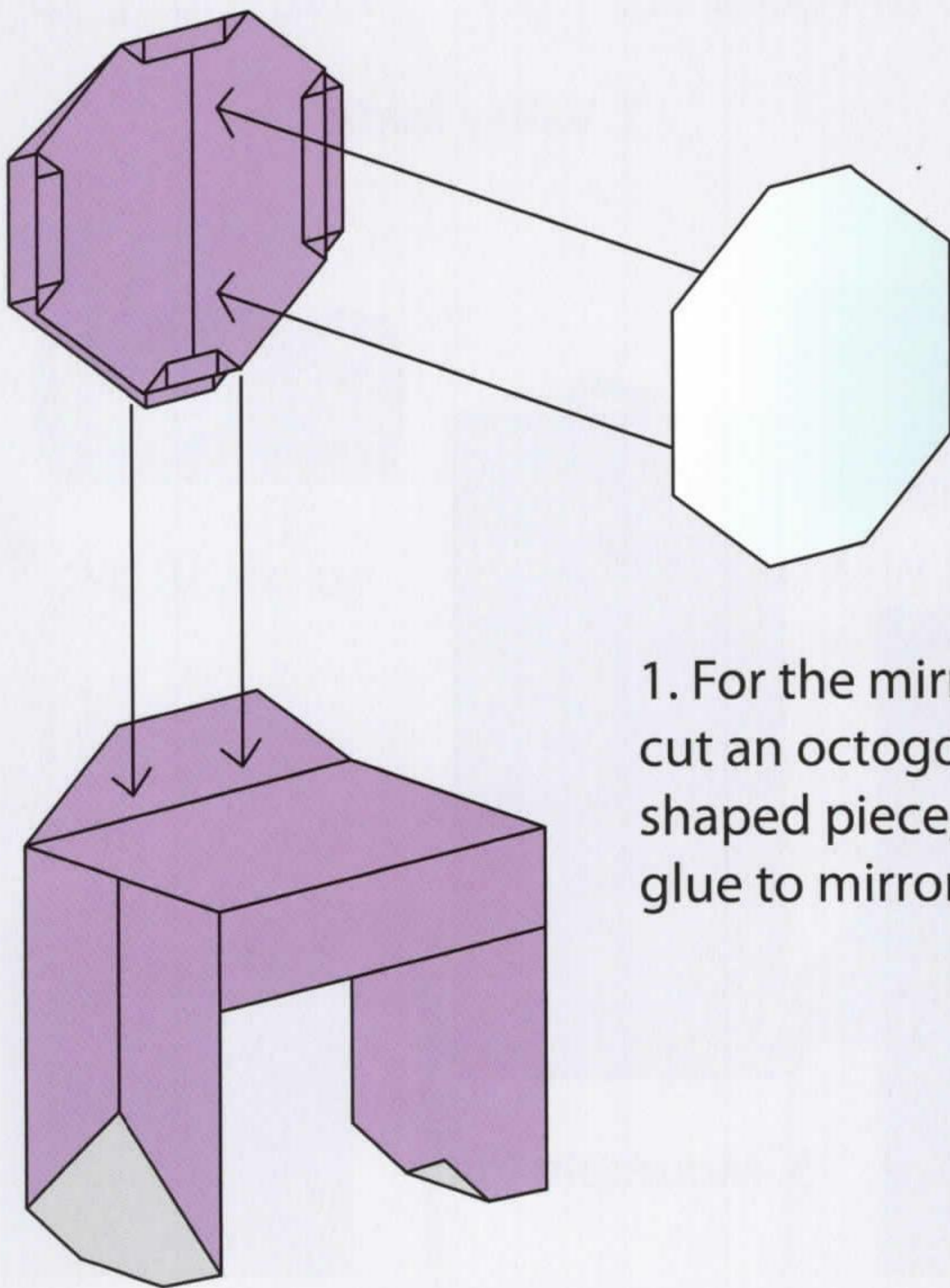

1. For the mirror glass, cut an octagonal shaped piece, and glue to mirror base.

2. Then join all parts together as shown and apply glue.

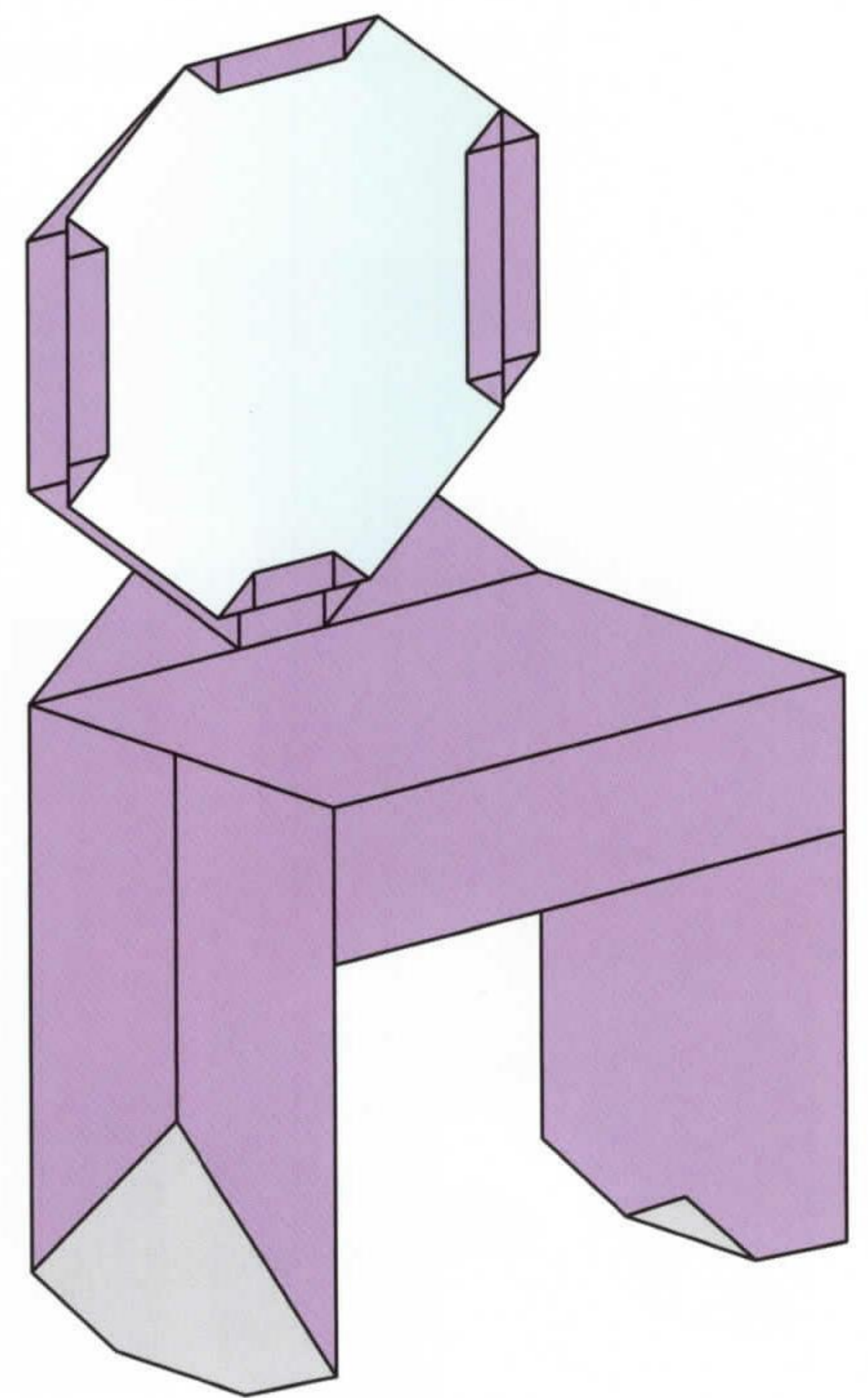

3. Completed VANITY TABLE

➤ vanity chair

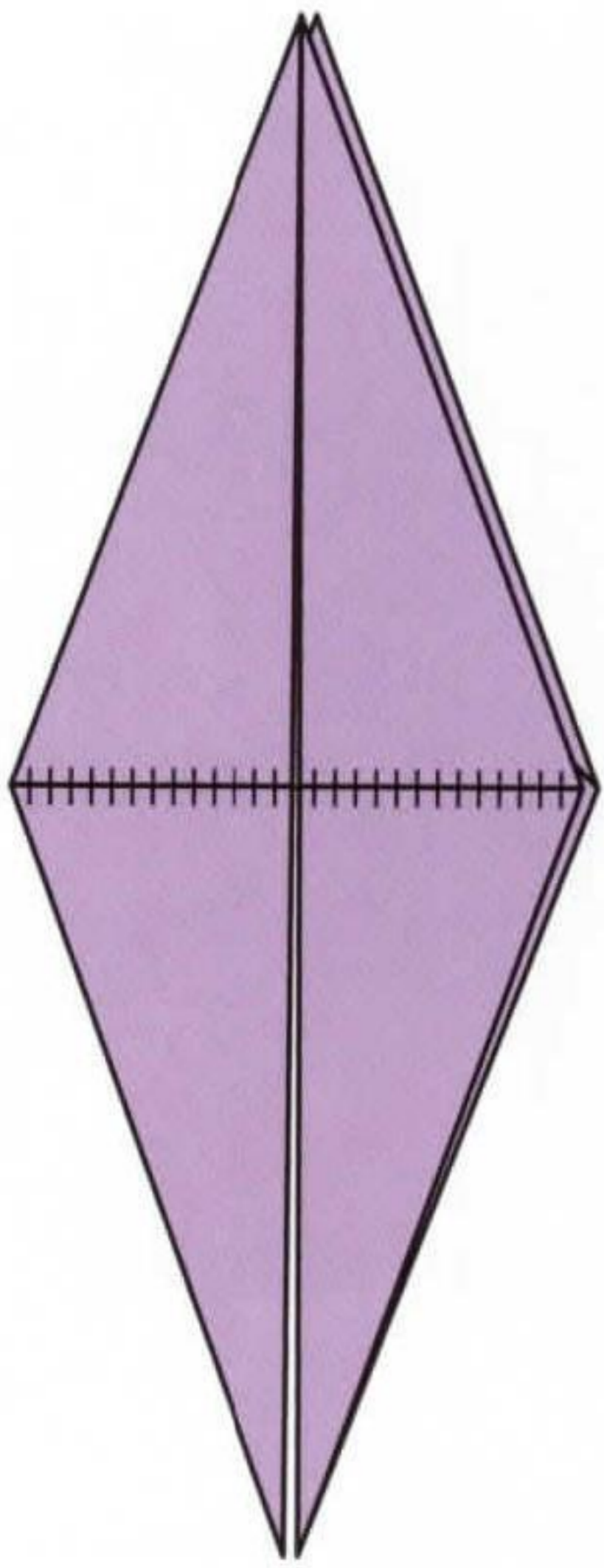

1. Bird Base, then cuts to the top layers

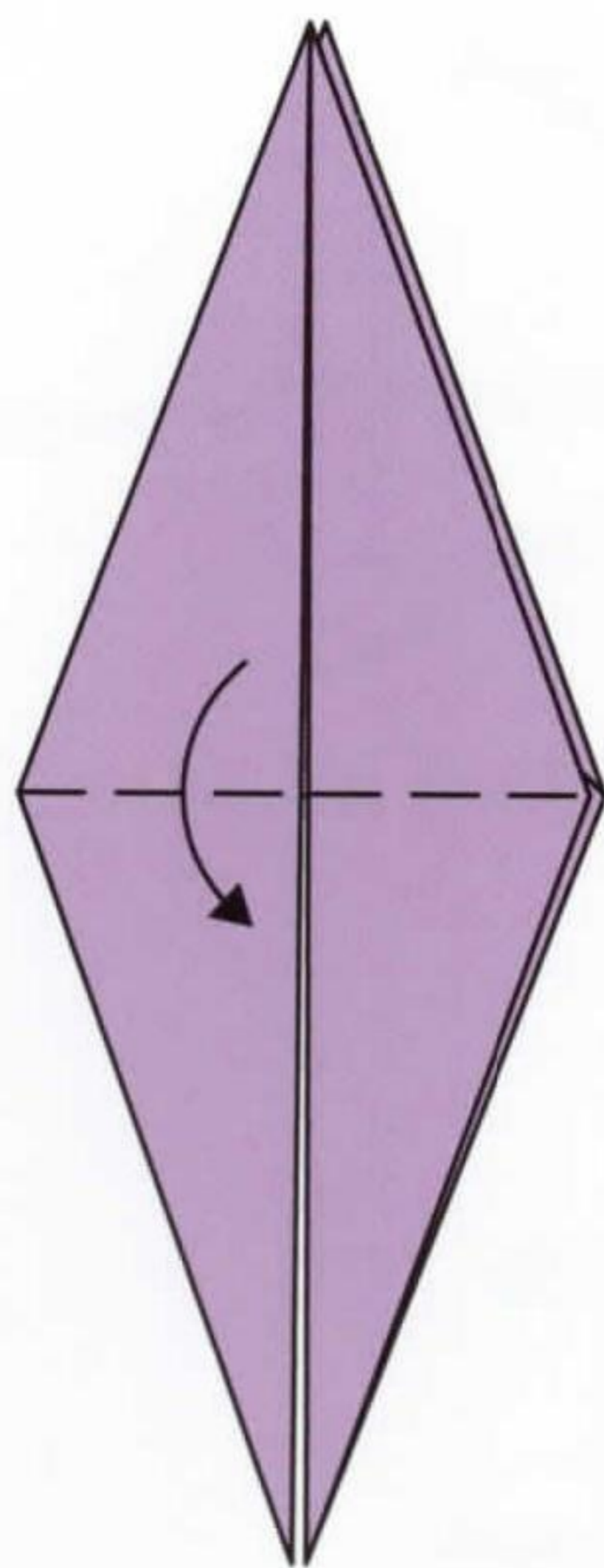

2. Valley fold both sides

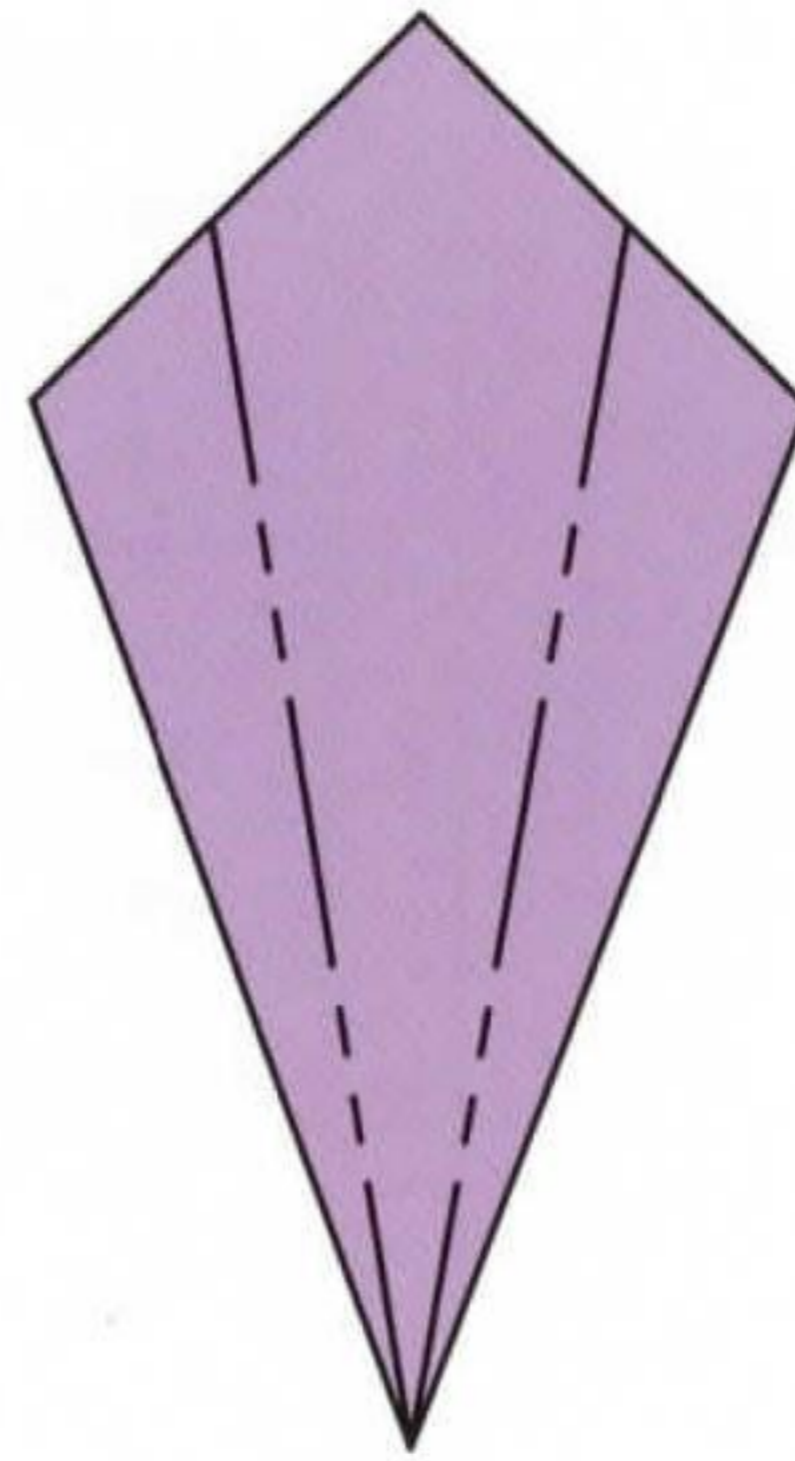

3. Inside reverse folds

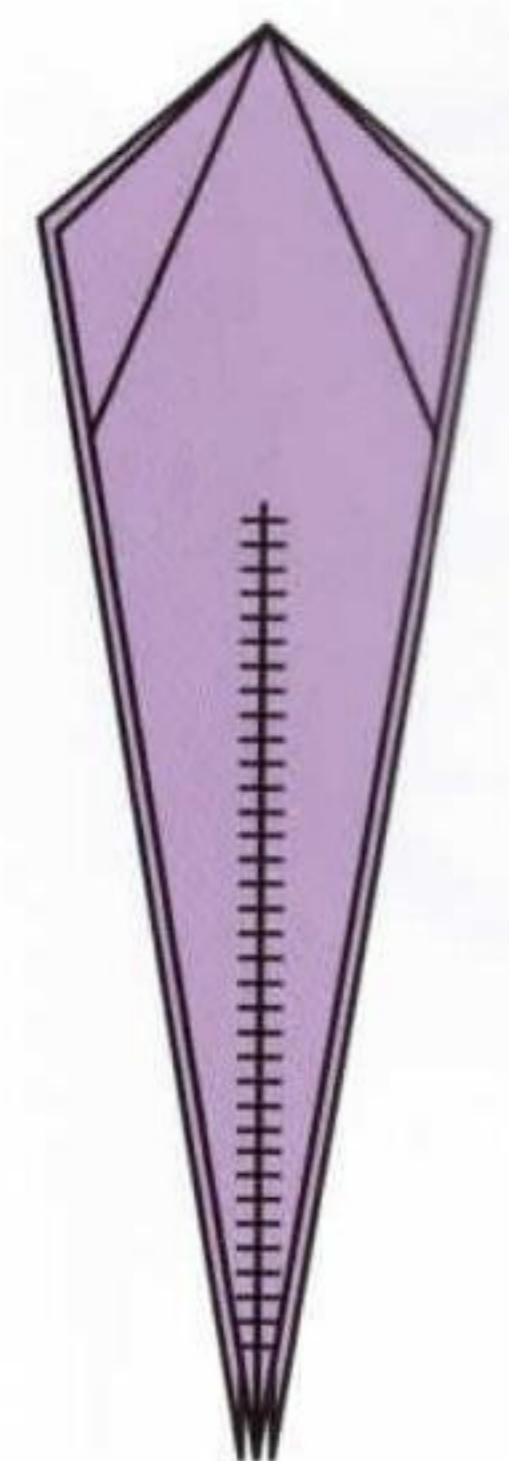

4. Cuts and valley folds

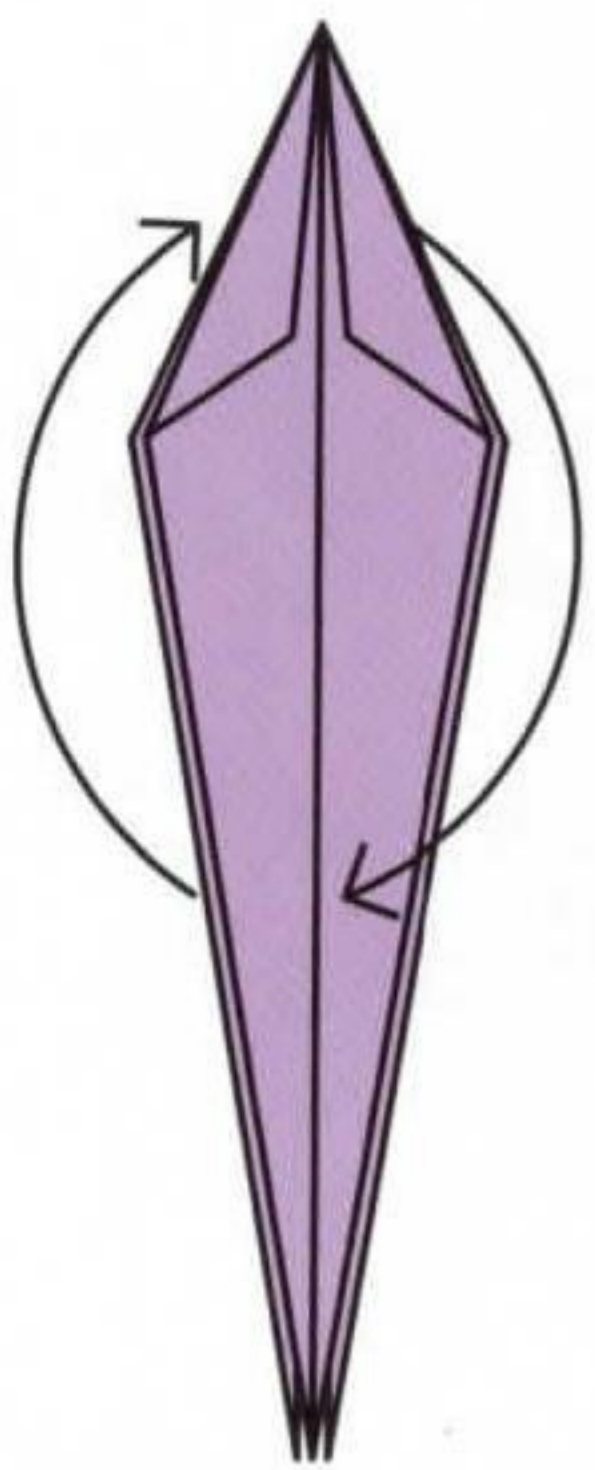

5. Open flaps

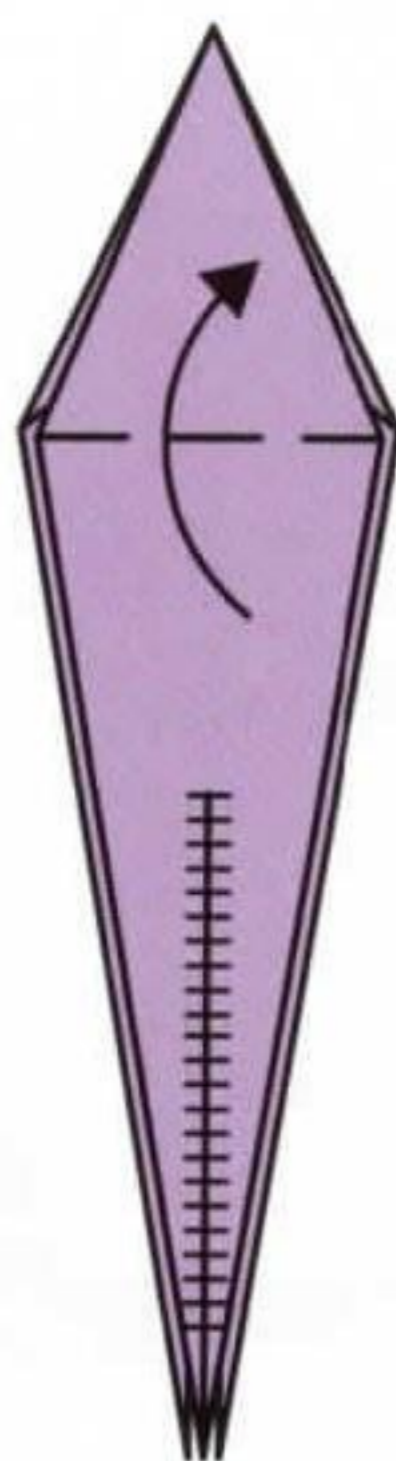

6. Cuts and Valley fold on the front layer only

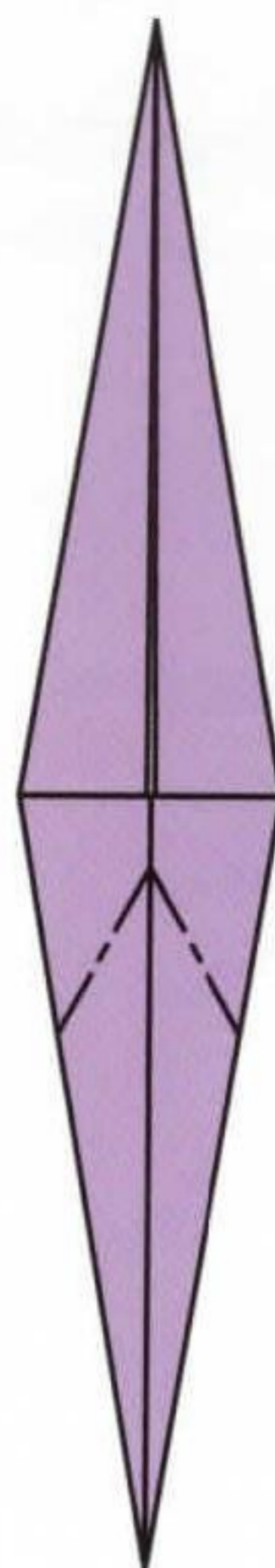

7. Mountain fold

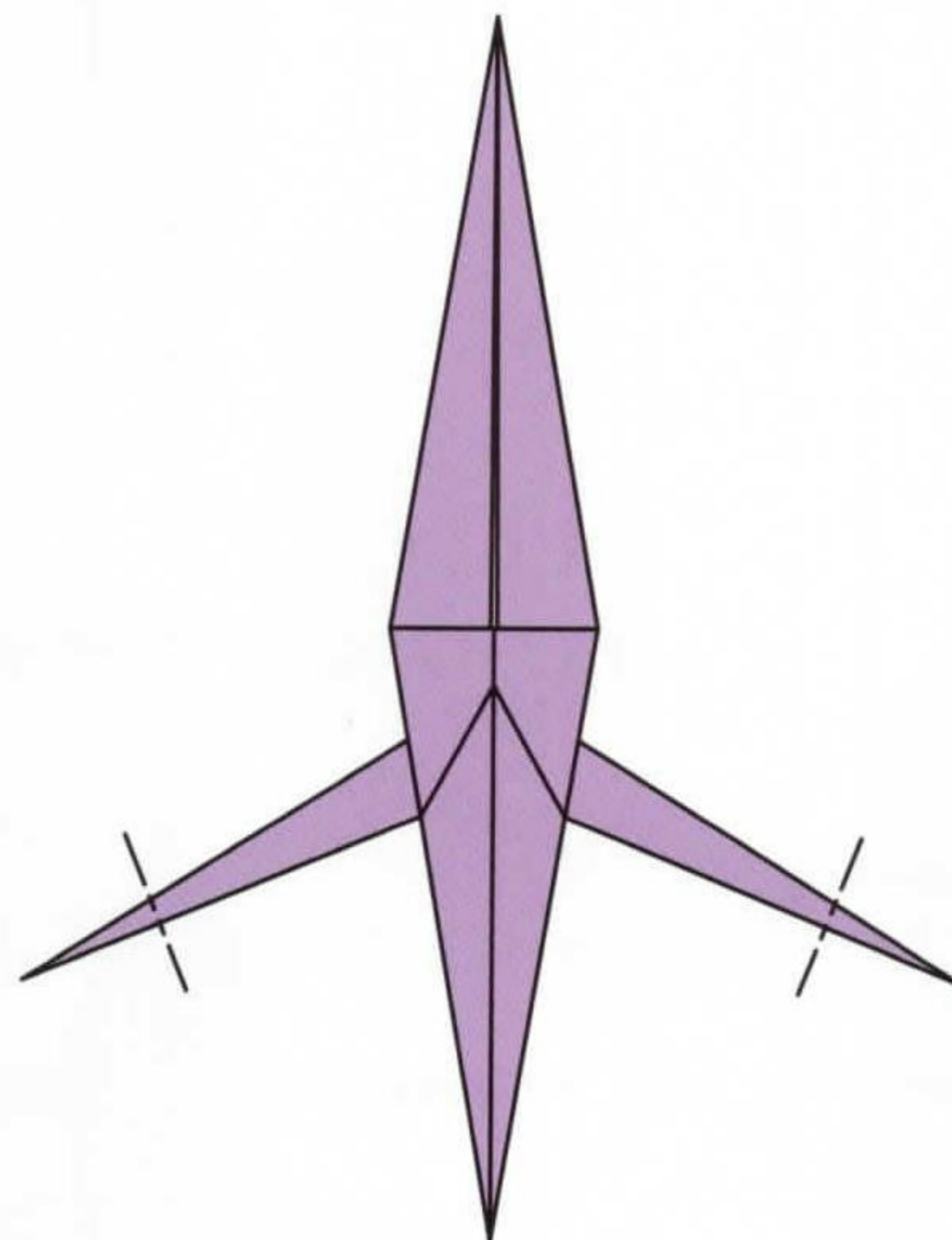

8. Inside reverse folds

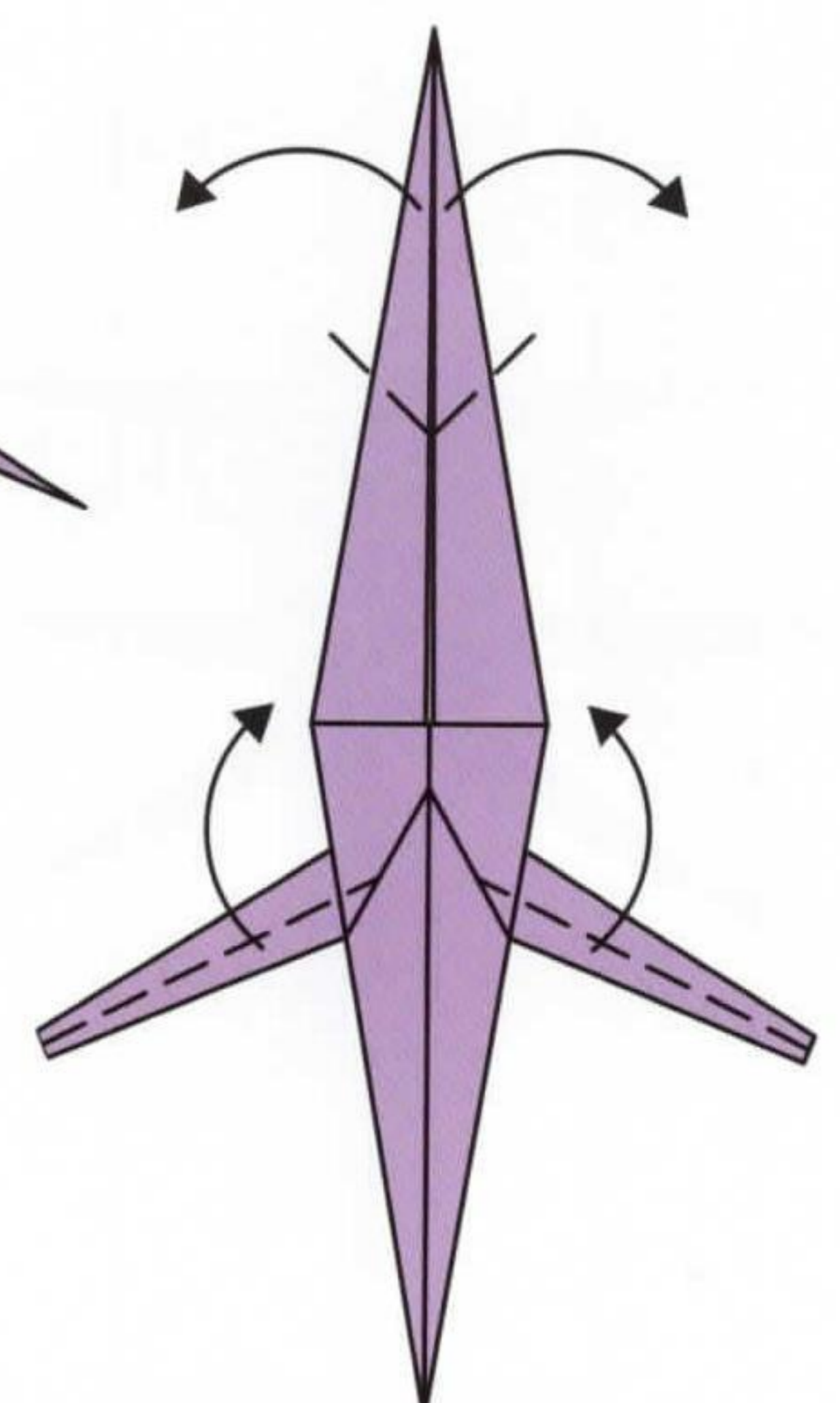

9. Valley folds

vanity chair

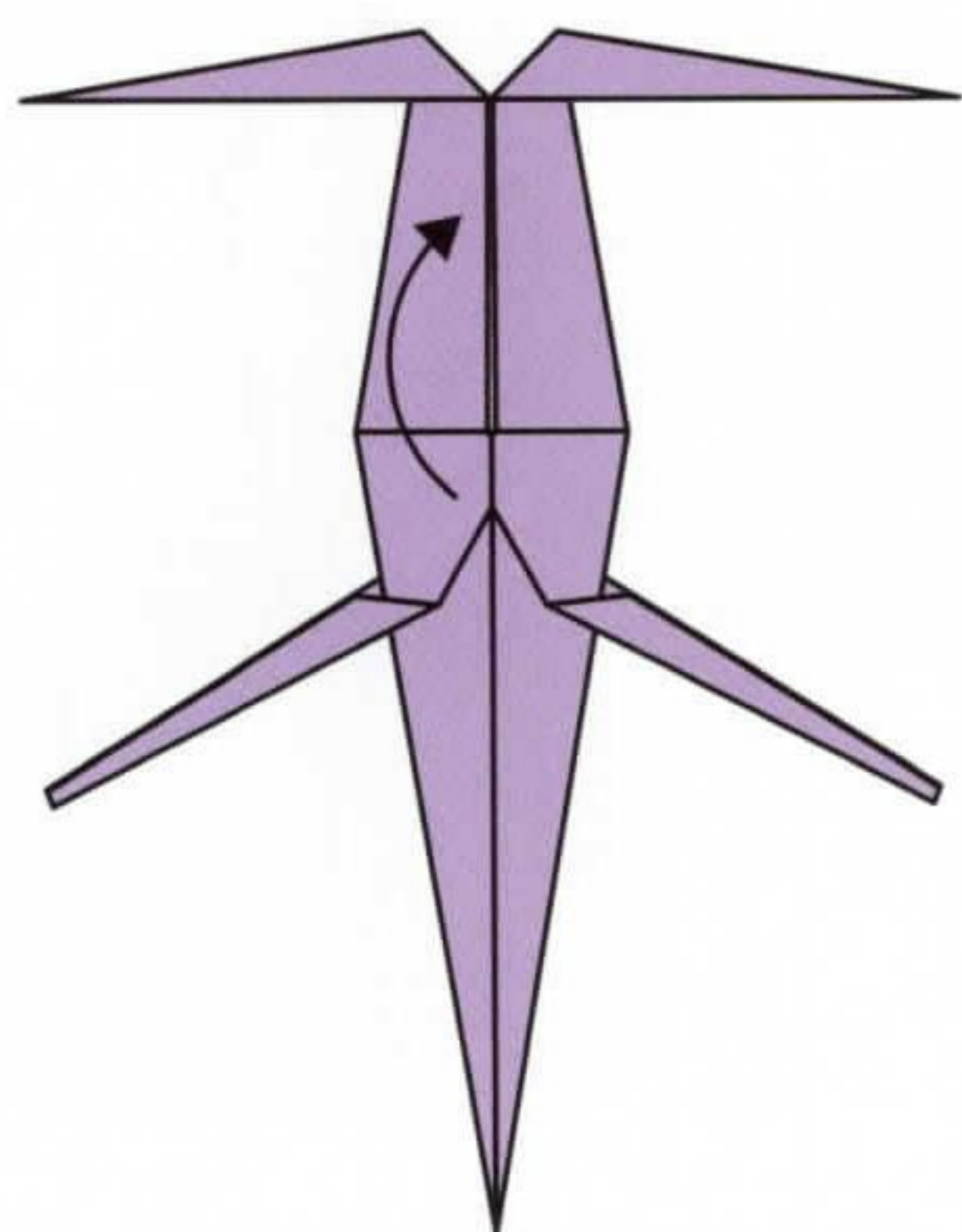

10. Valley fold

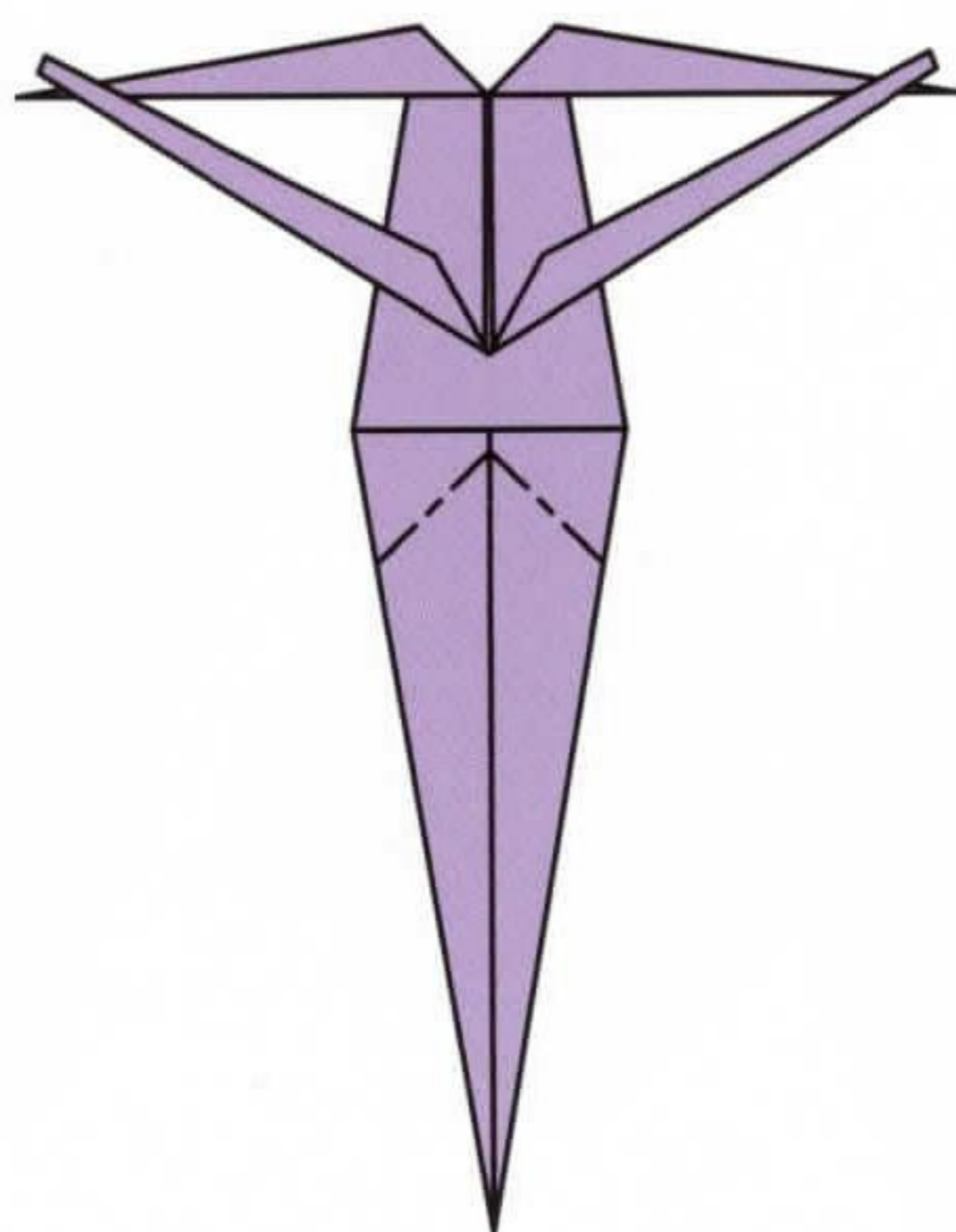

11. Mountain folds

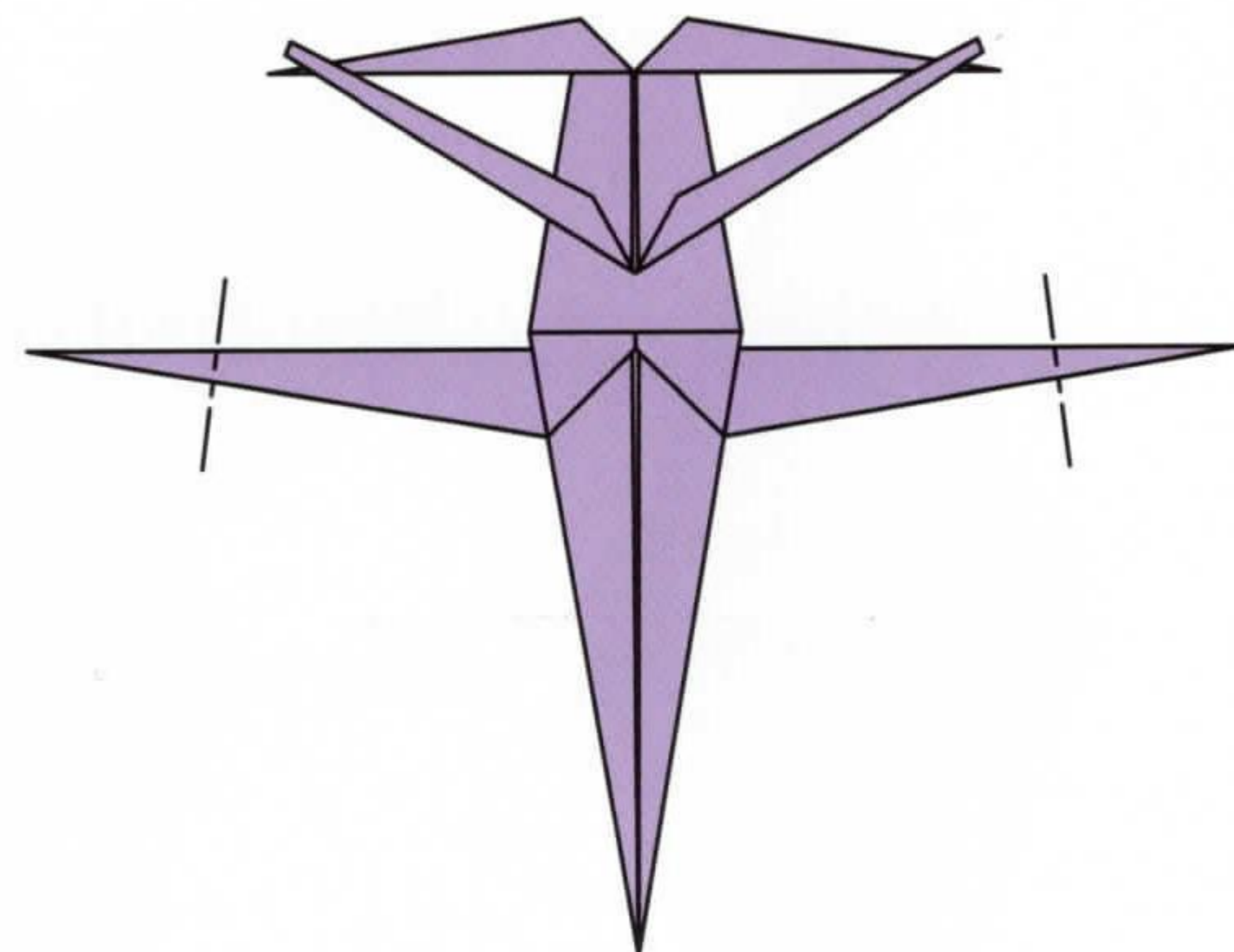

12. Inside reverse folds

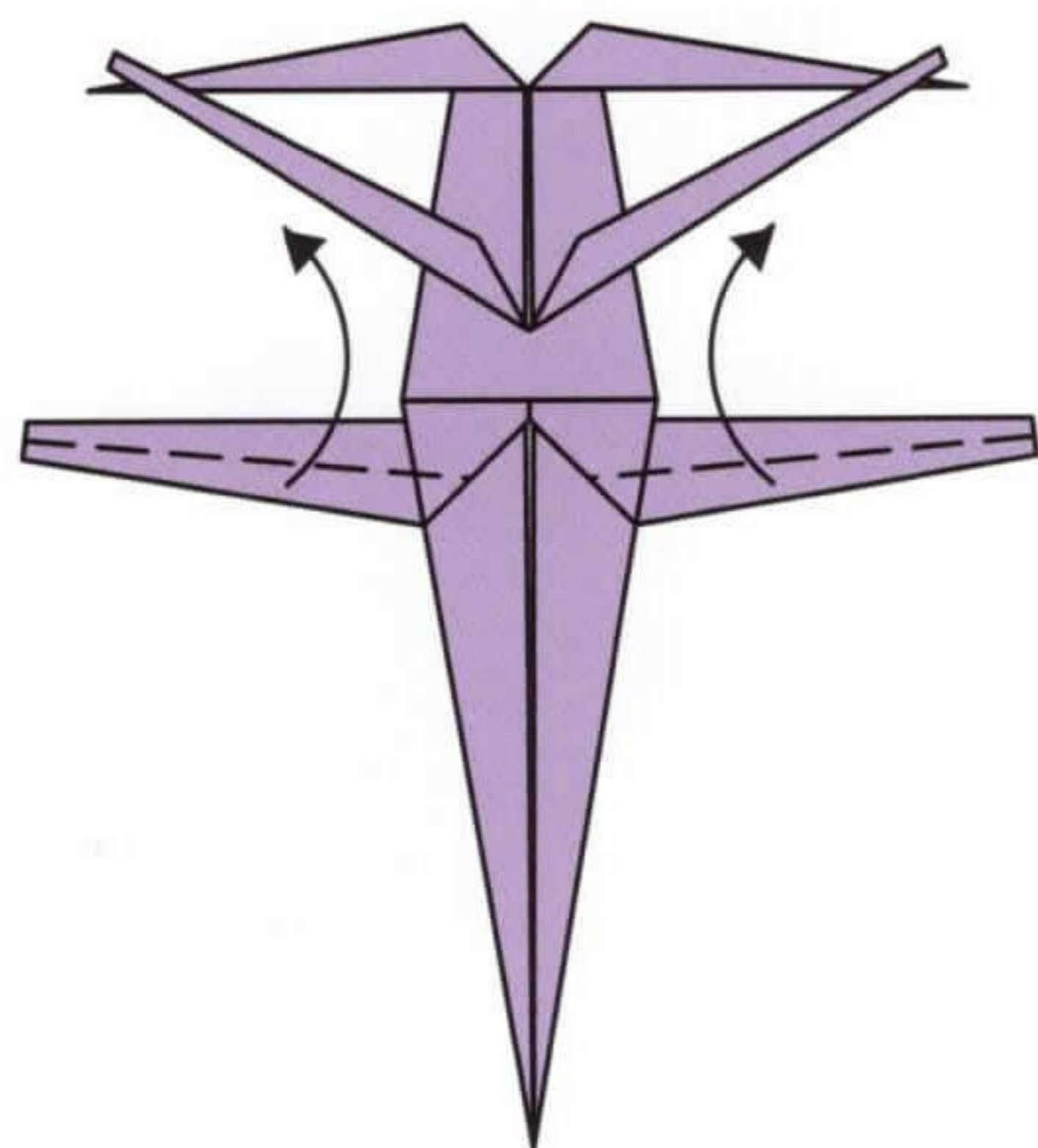

13. Valley folds

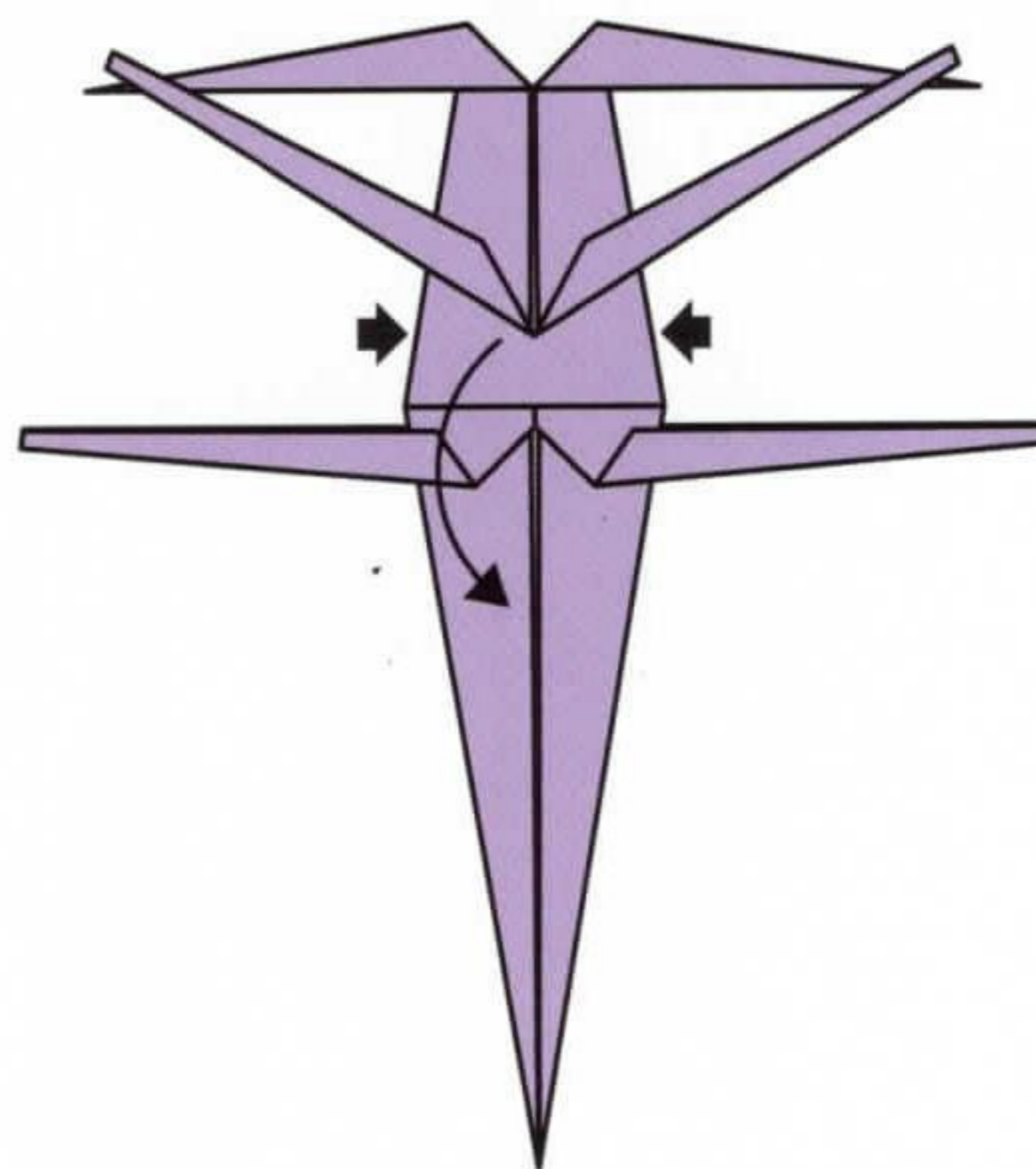

14. Add glue then valley fold

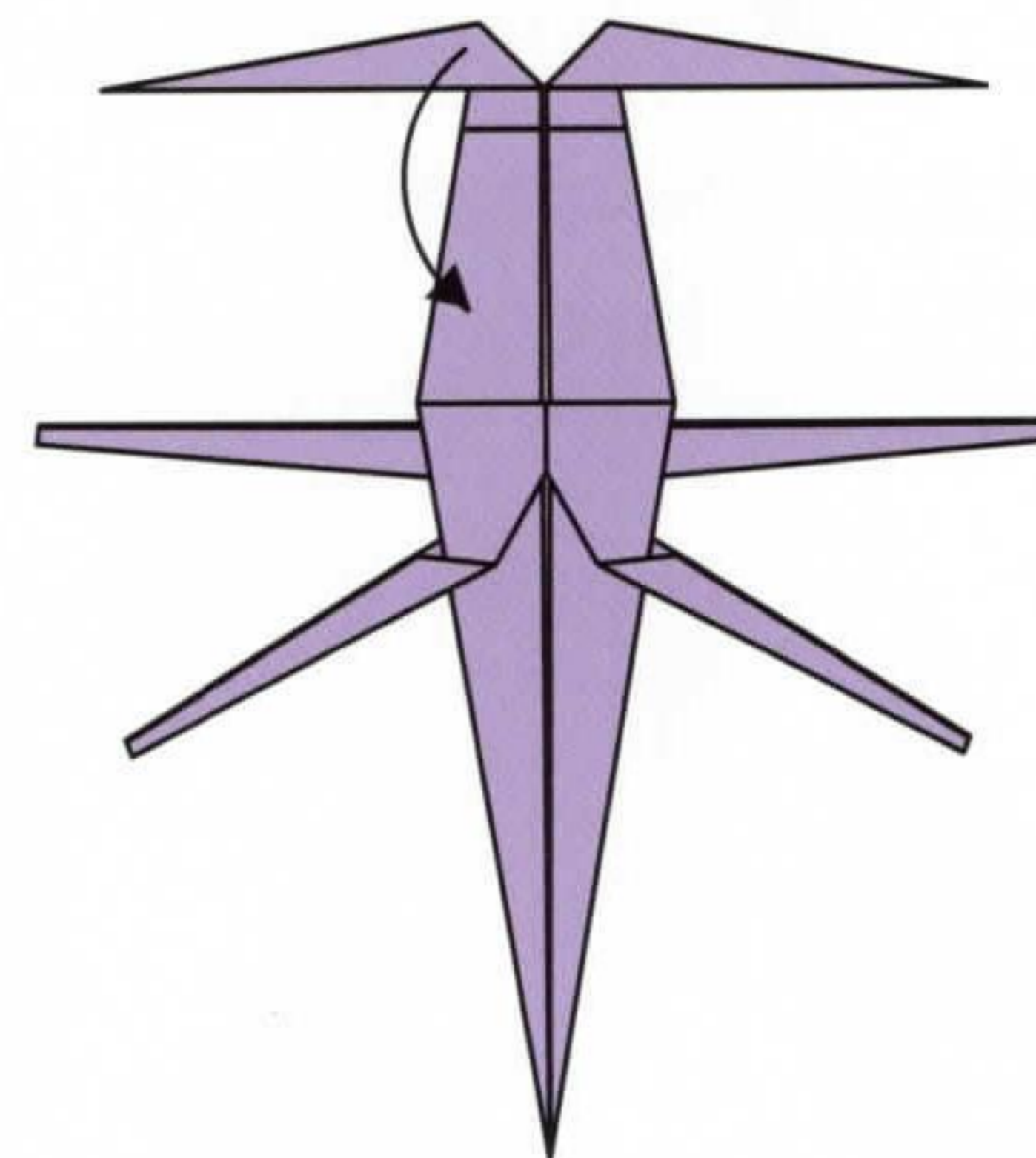

15. Repeat

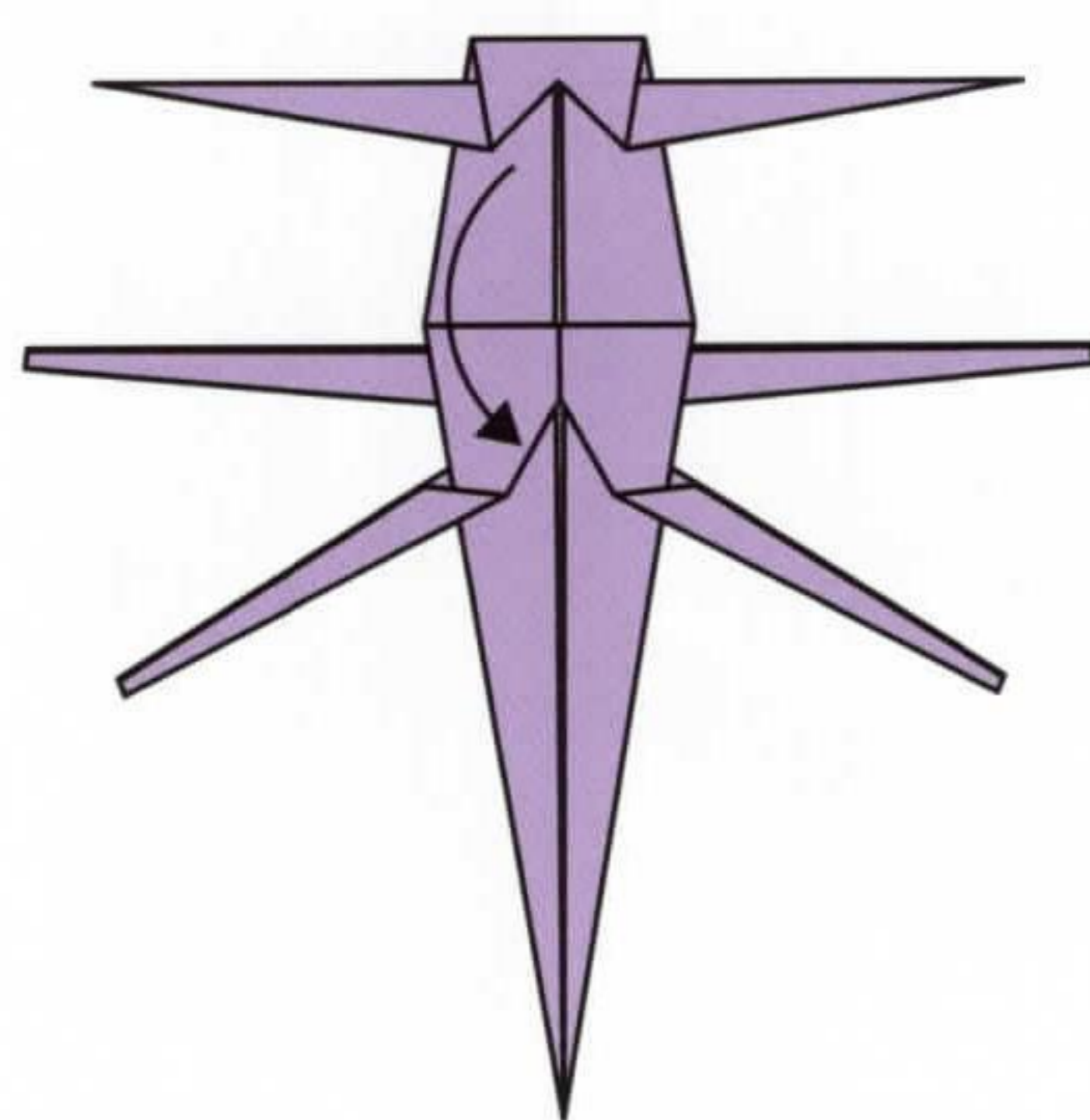

16. Add glue then valley fold

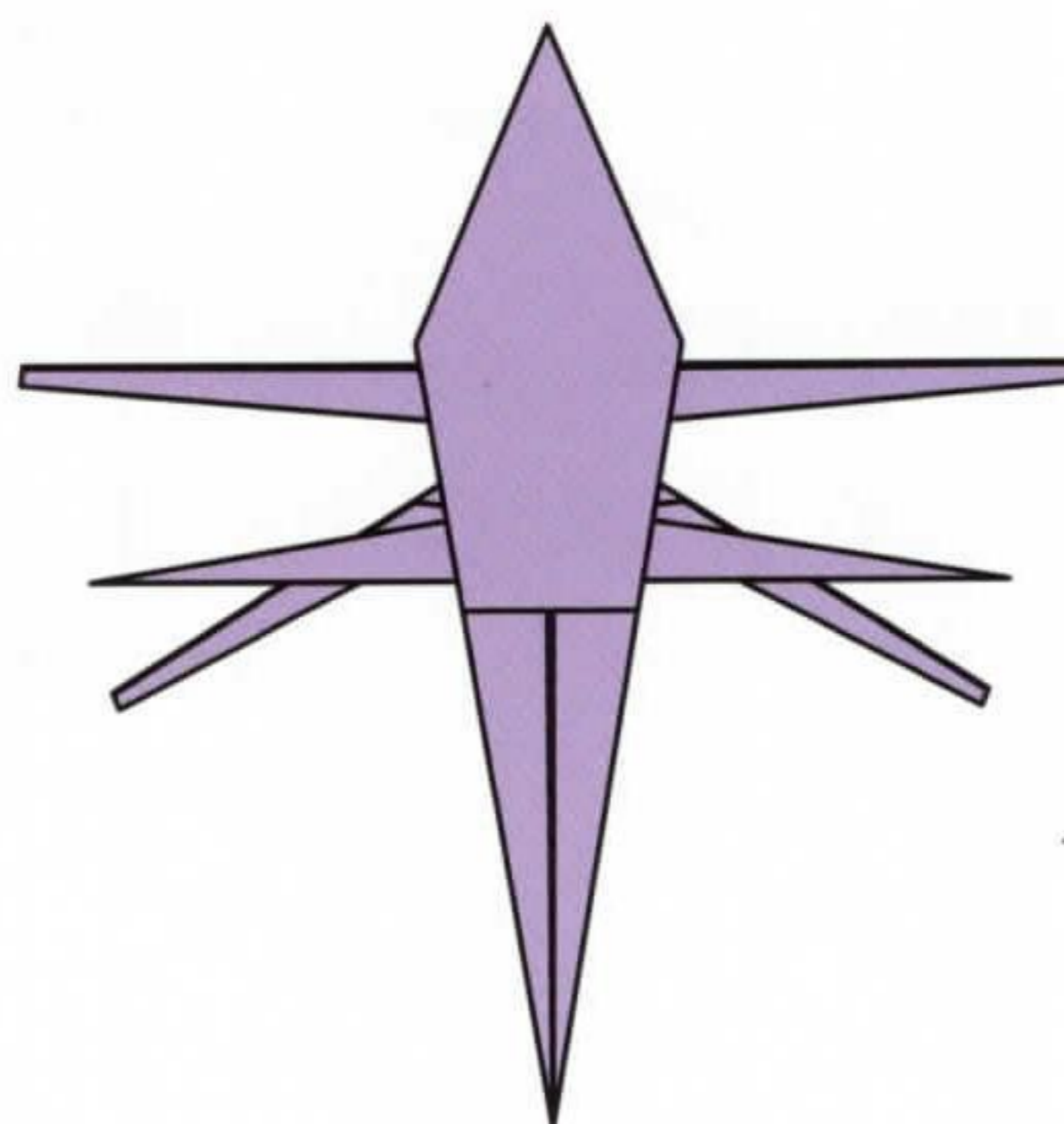

17. Turn over

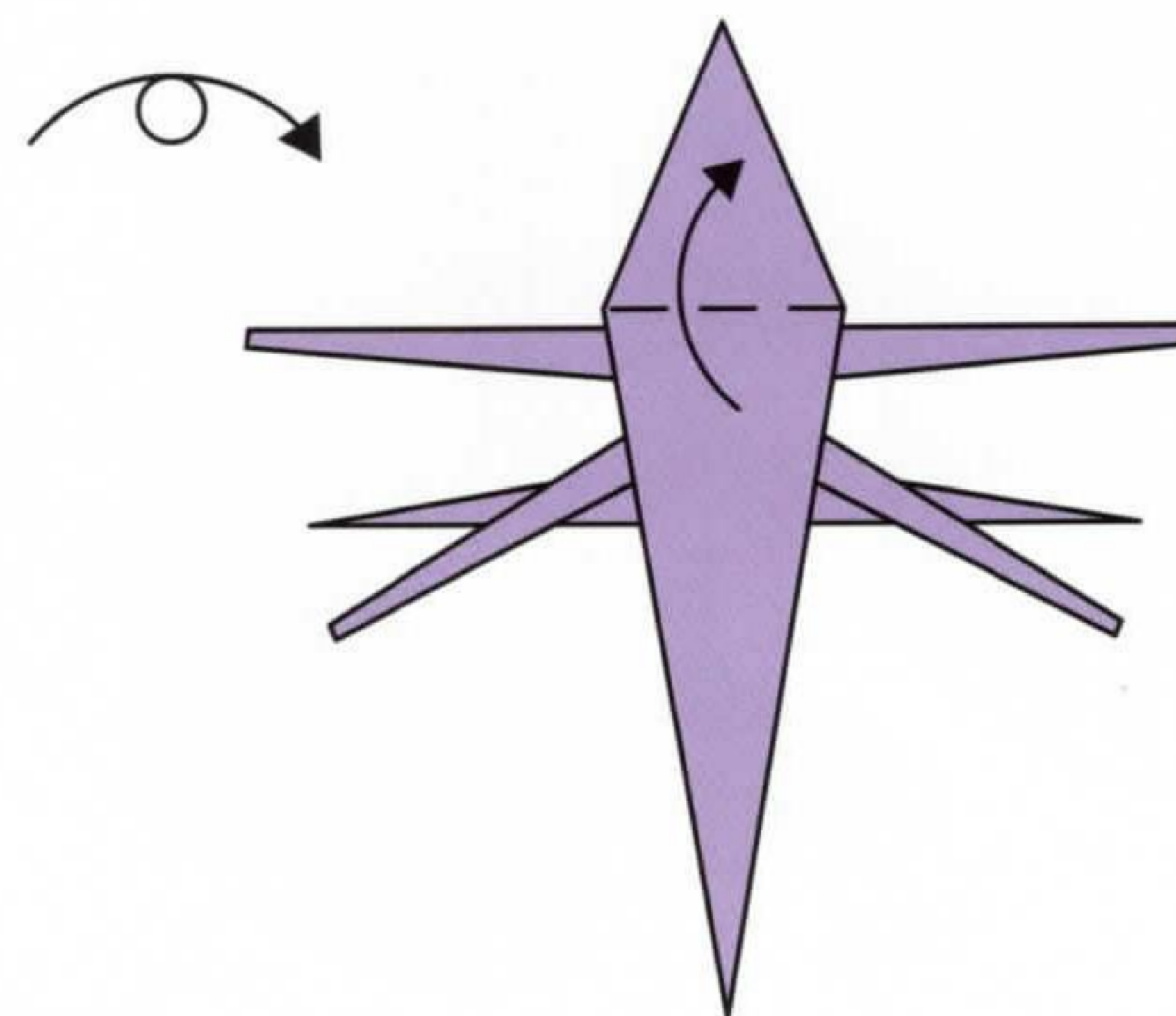

18. Valley fold

vanity chair

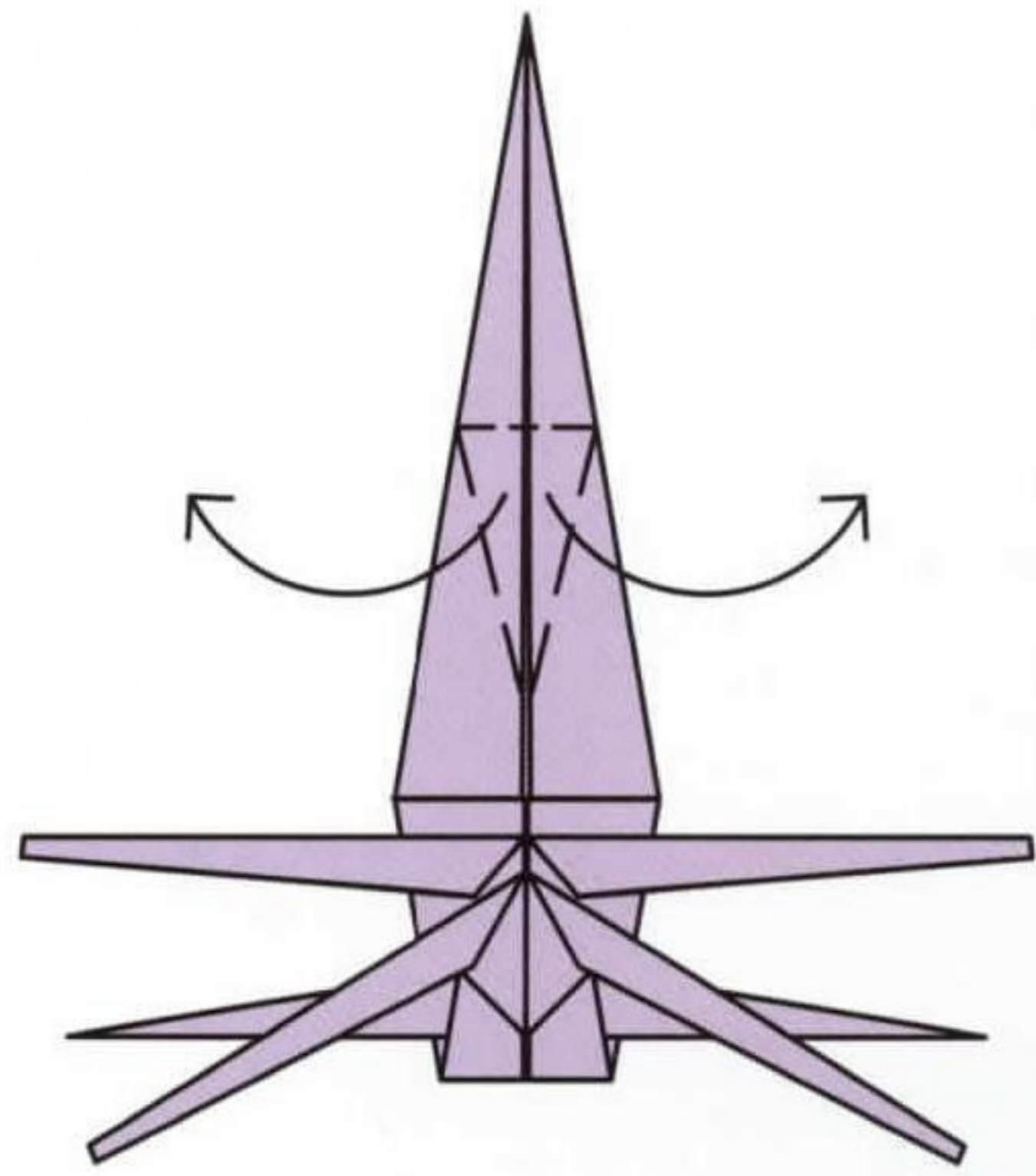

19. Squash folds

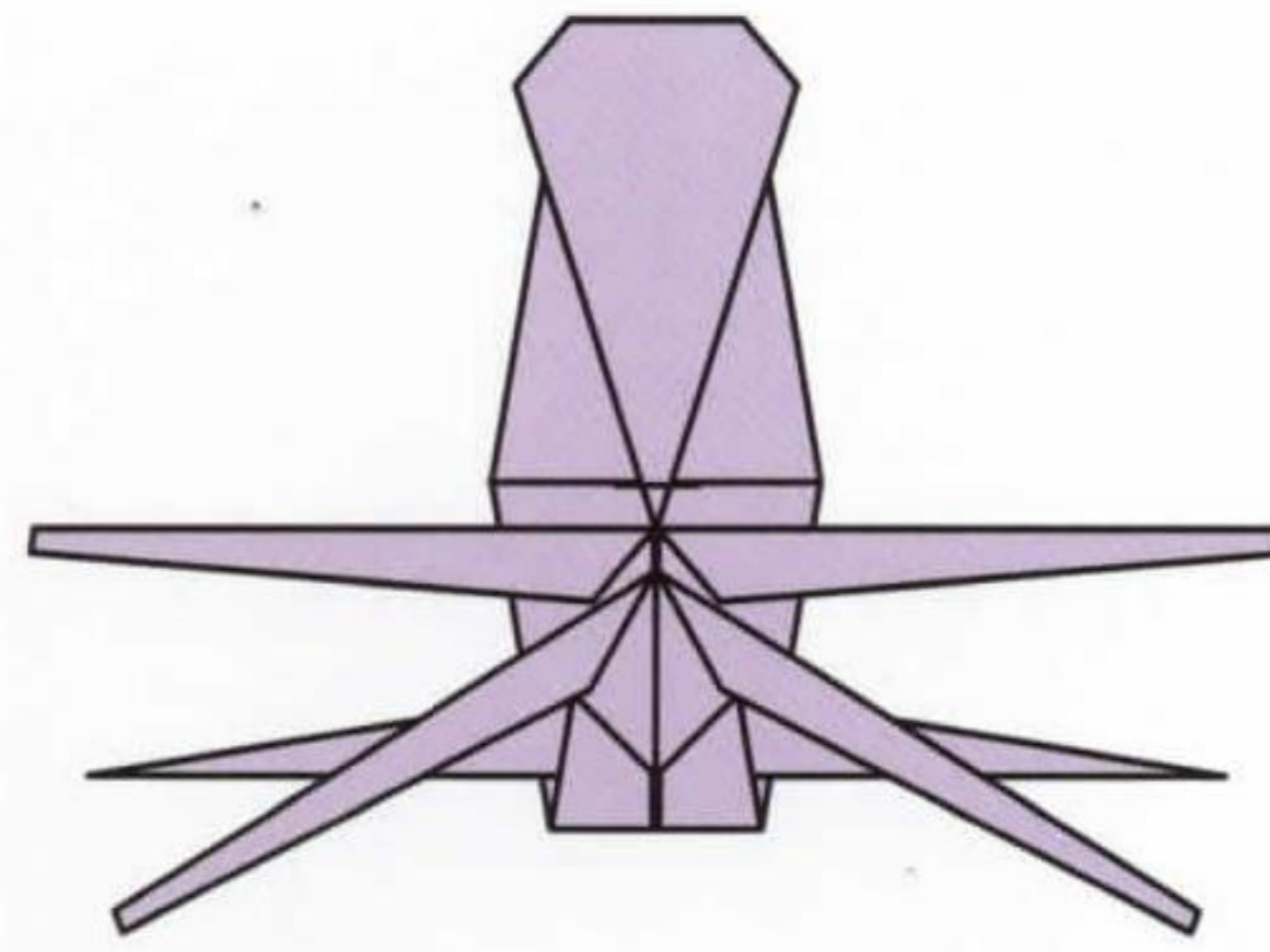

20. Tuck between layers

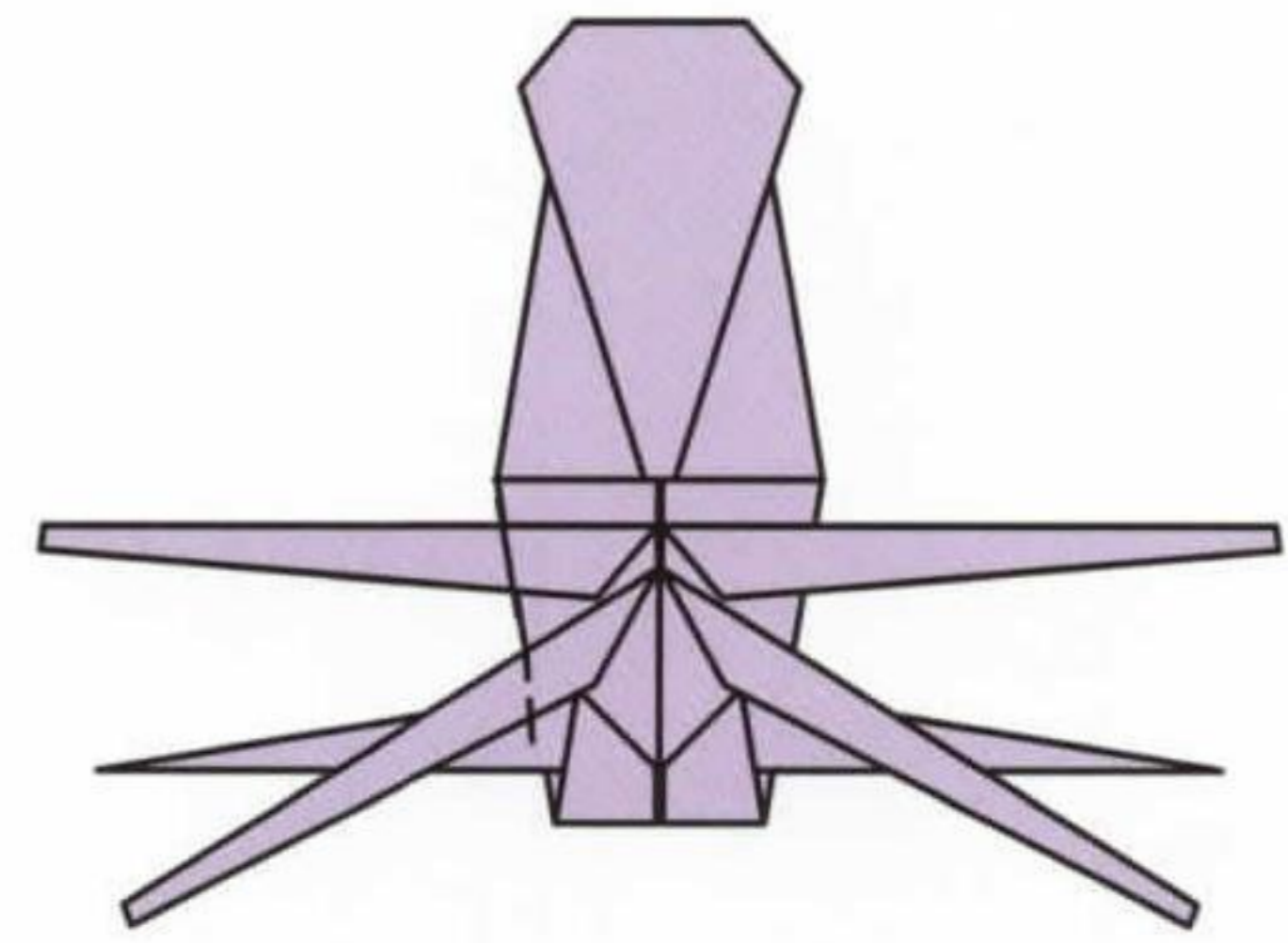

21. Valley folds

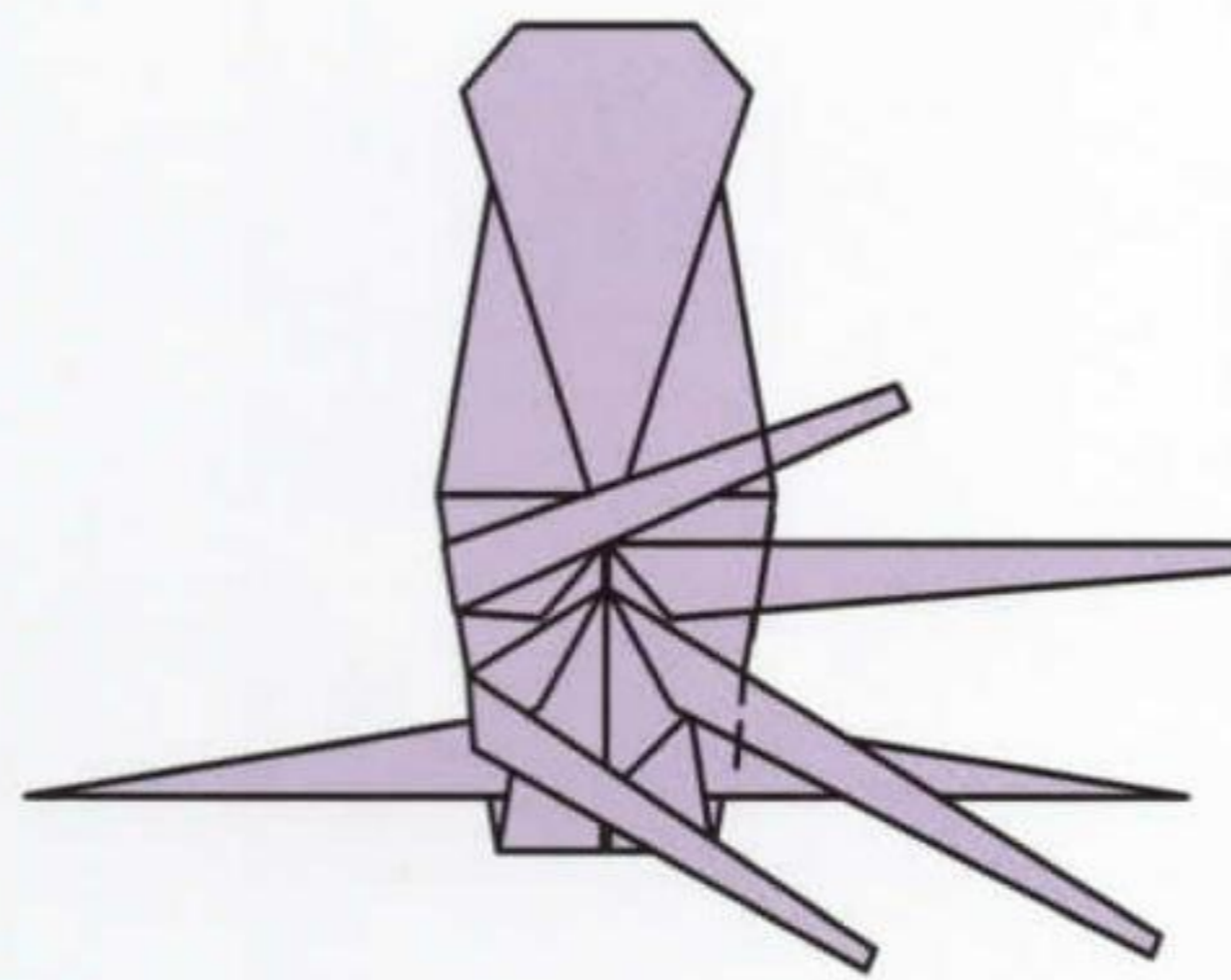

22. Valley folds

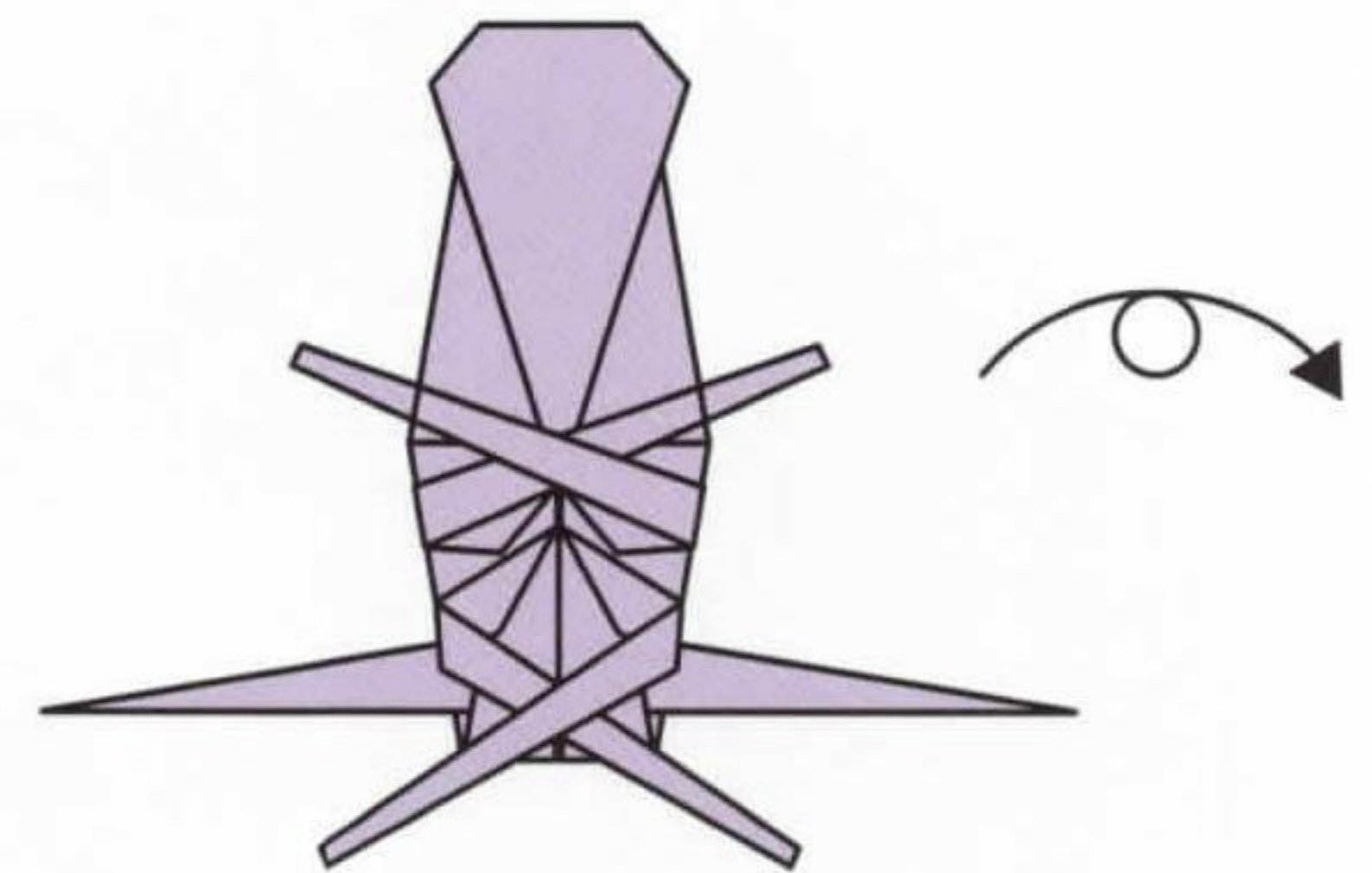

23. Turn over

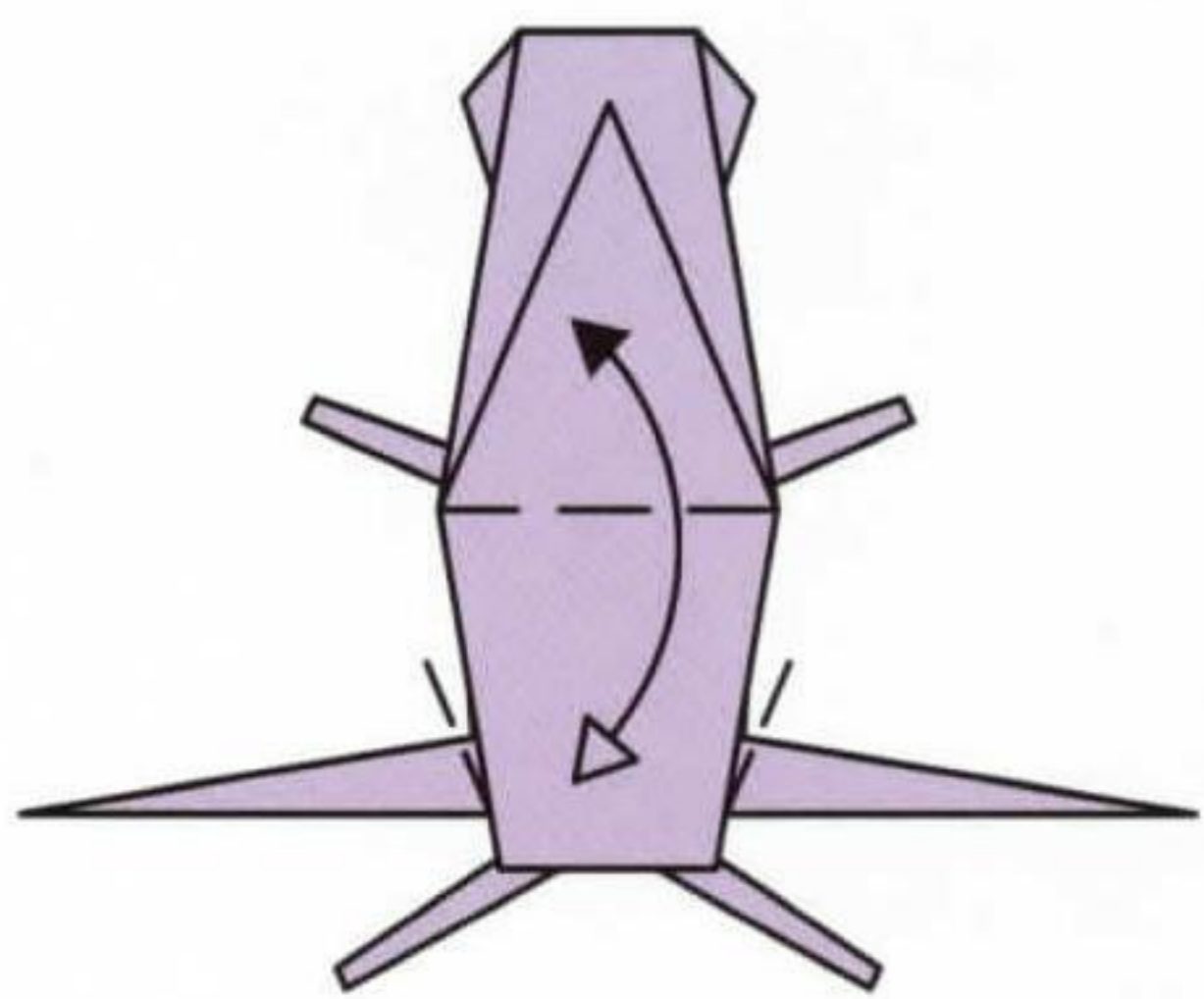

24. Valley folds and unfold

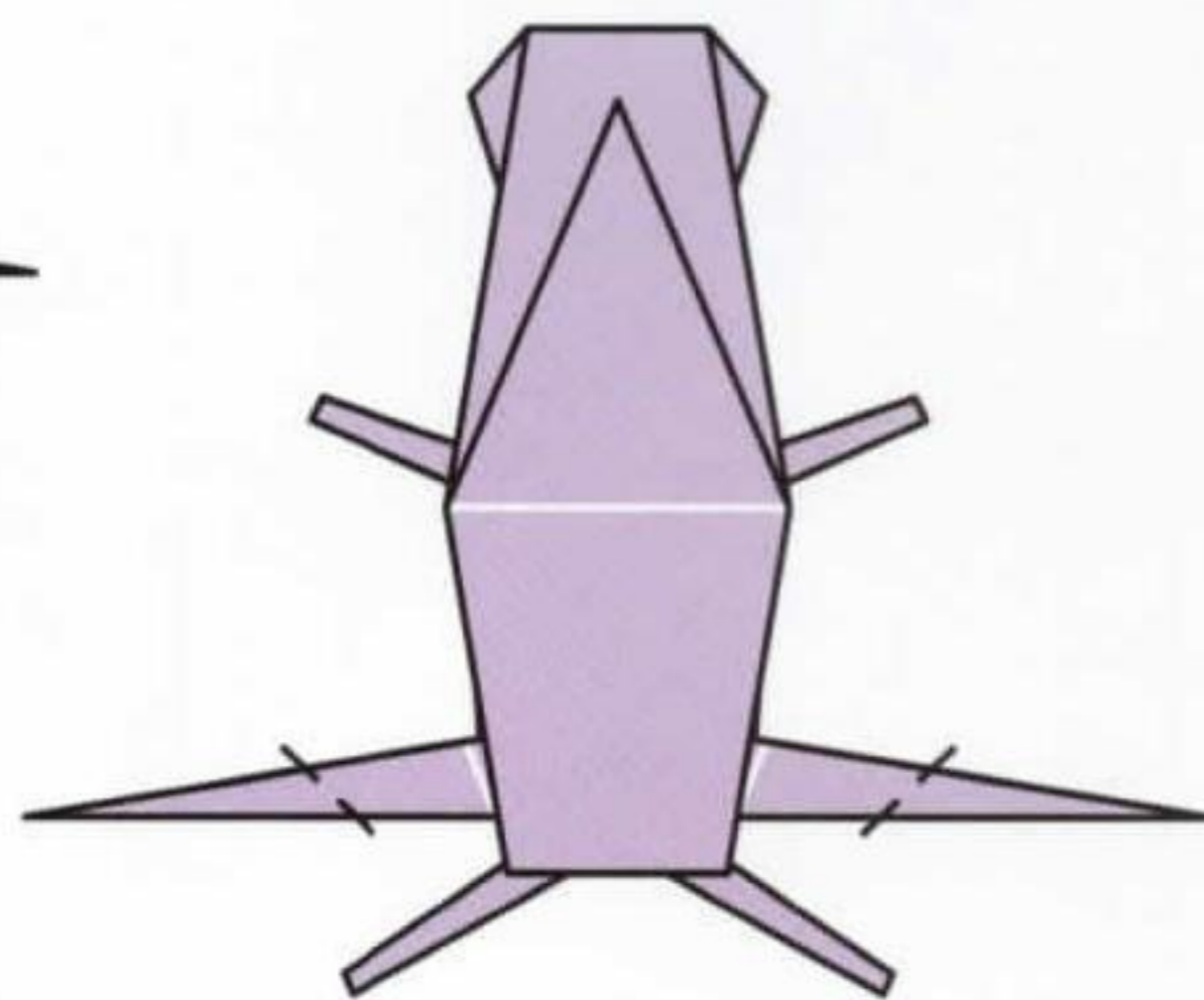

25. Valley folds

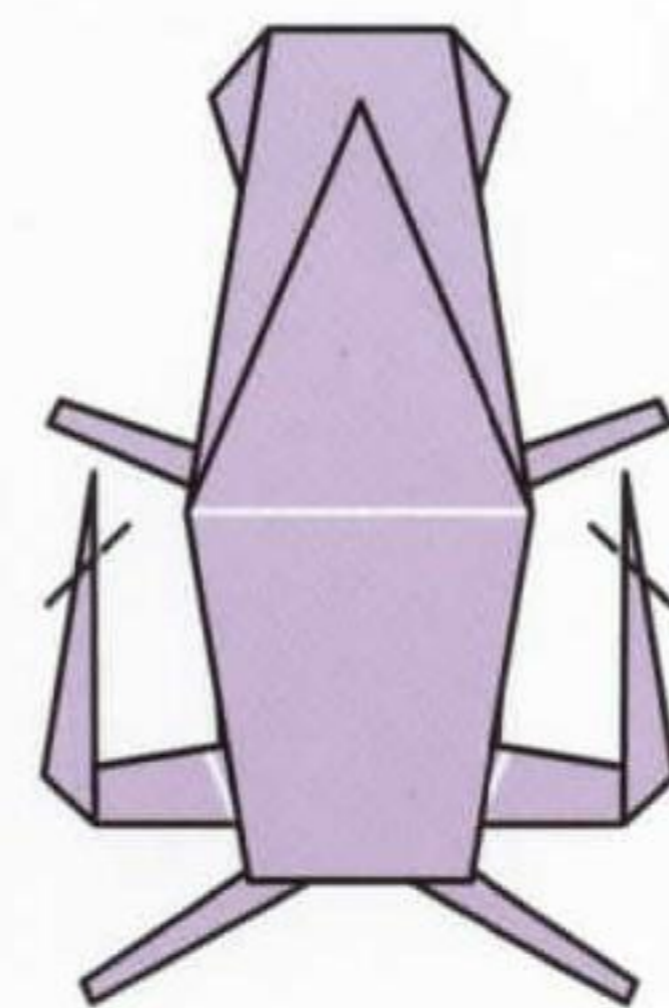

26. Mountain folds

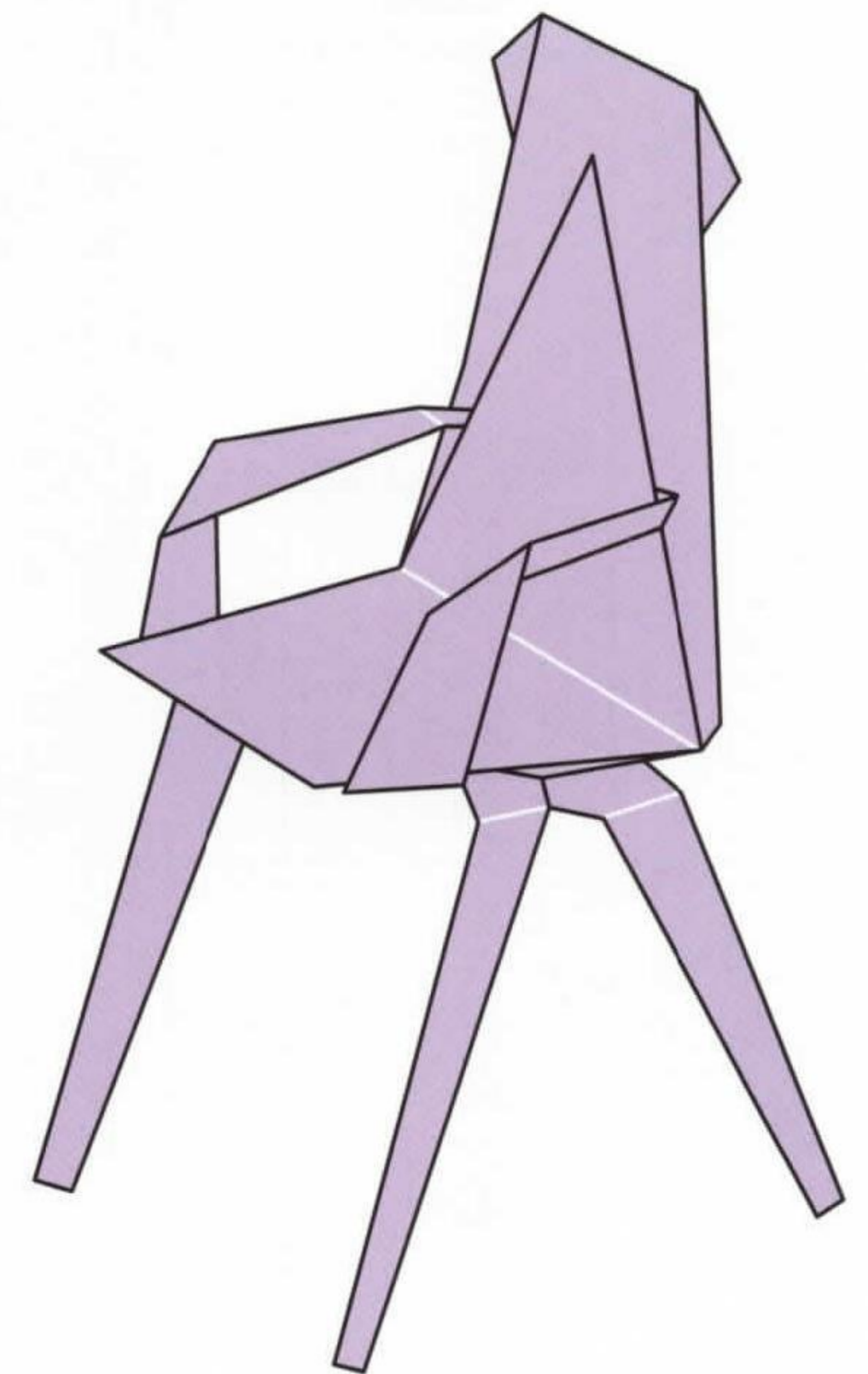

29. Completed VANITY CHAIR

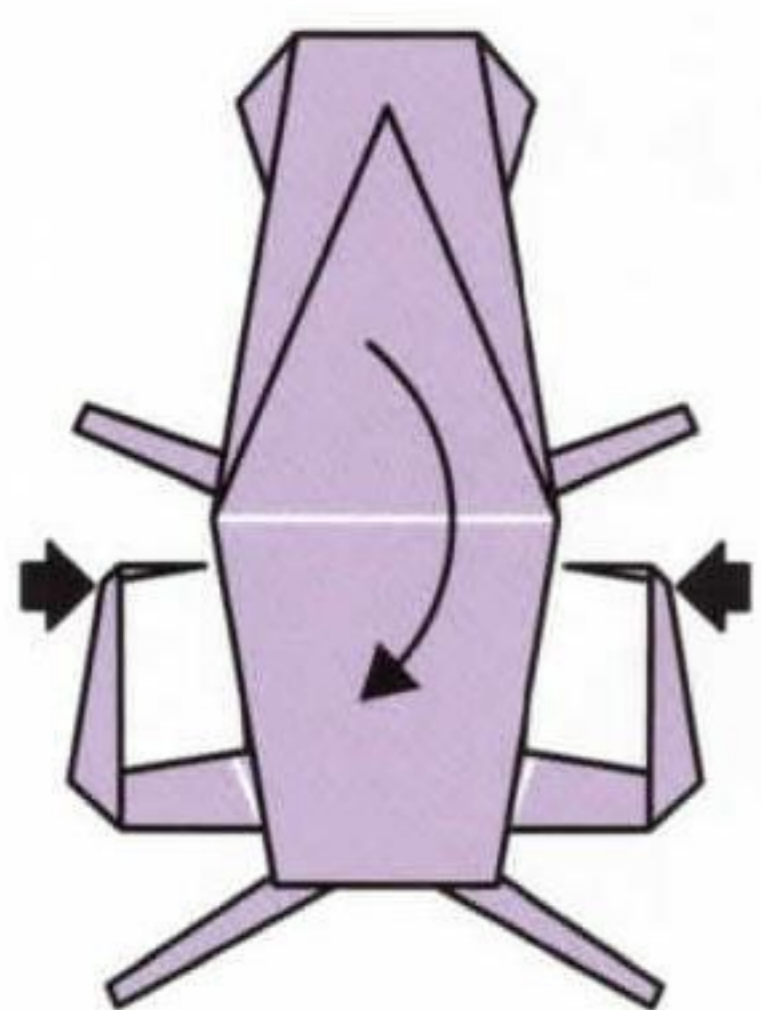

27. Valley fold back section up and apply glue

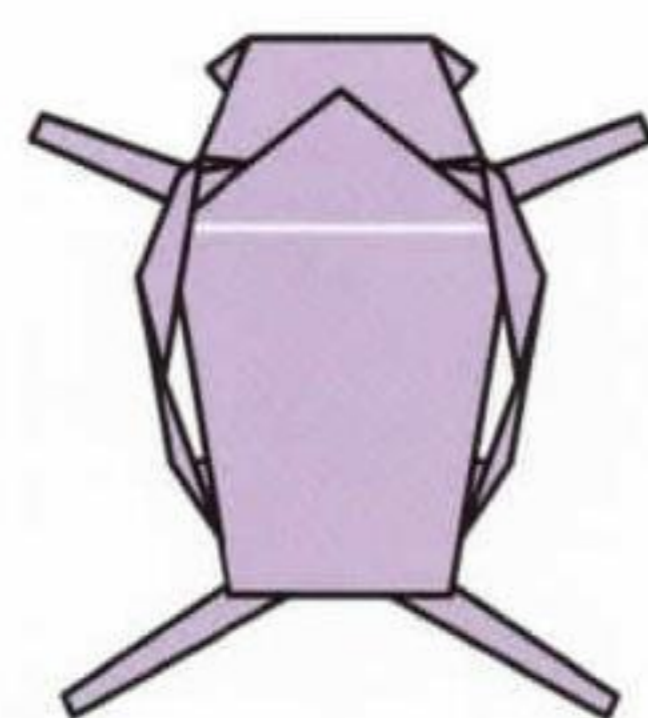

28. Unfold legs

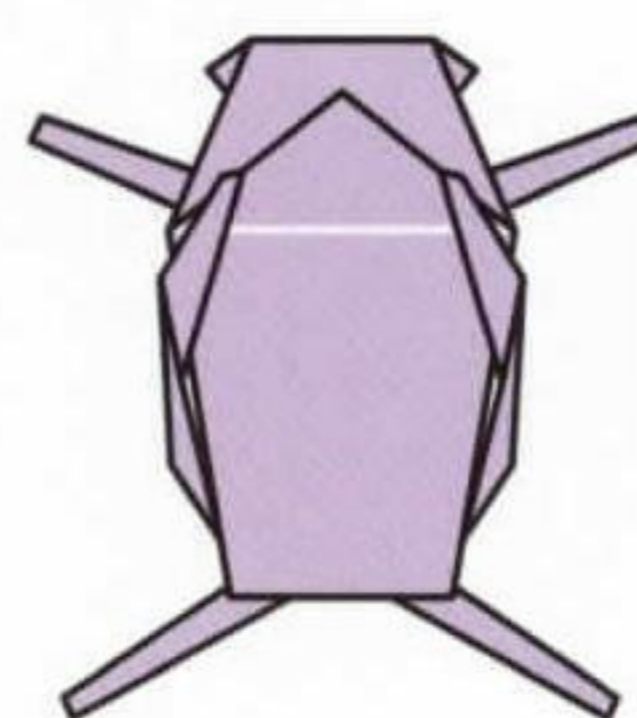



8

accessories

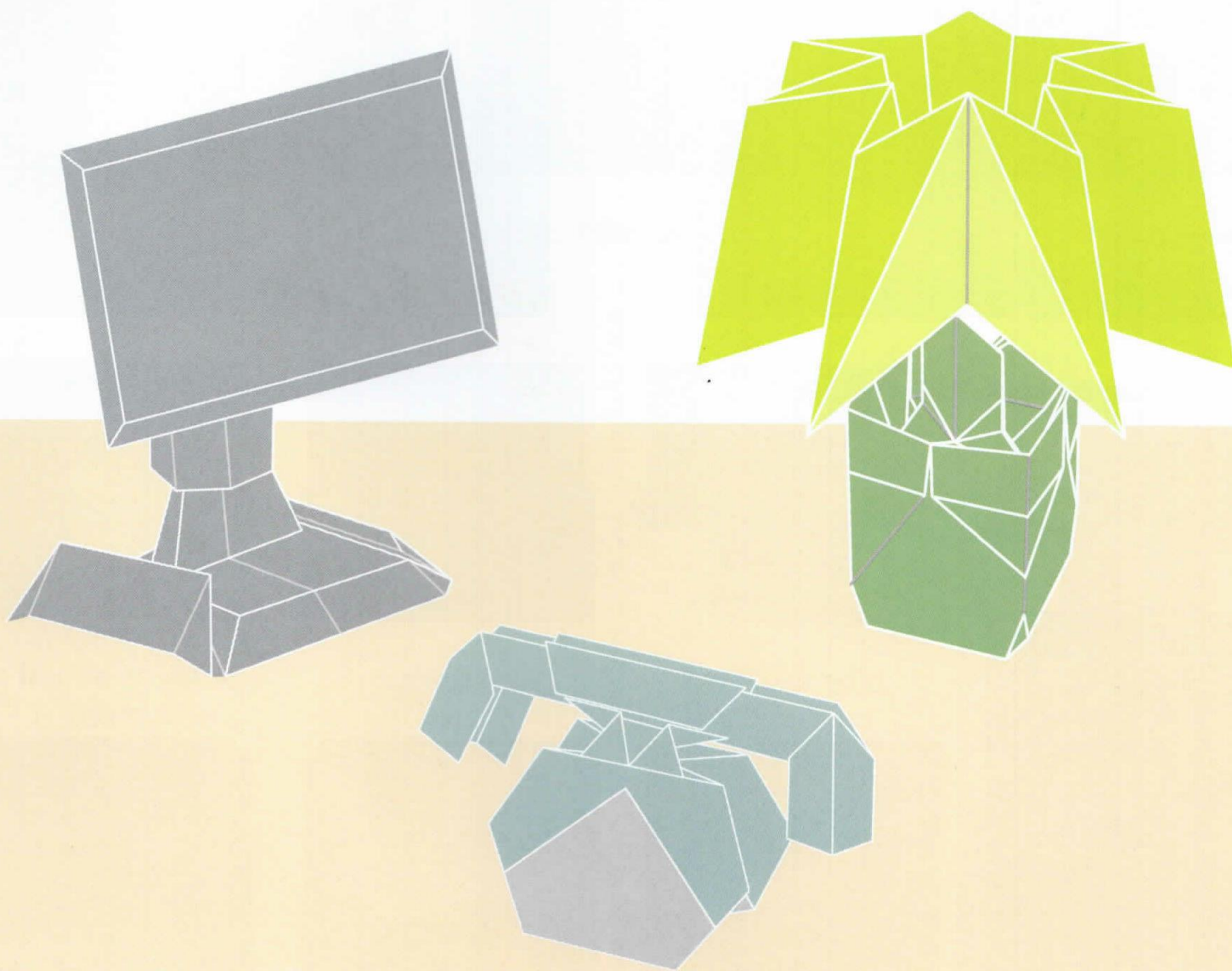

television | table lamp | telephone

► television: part 1

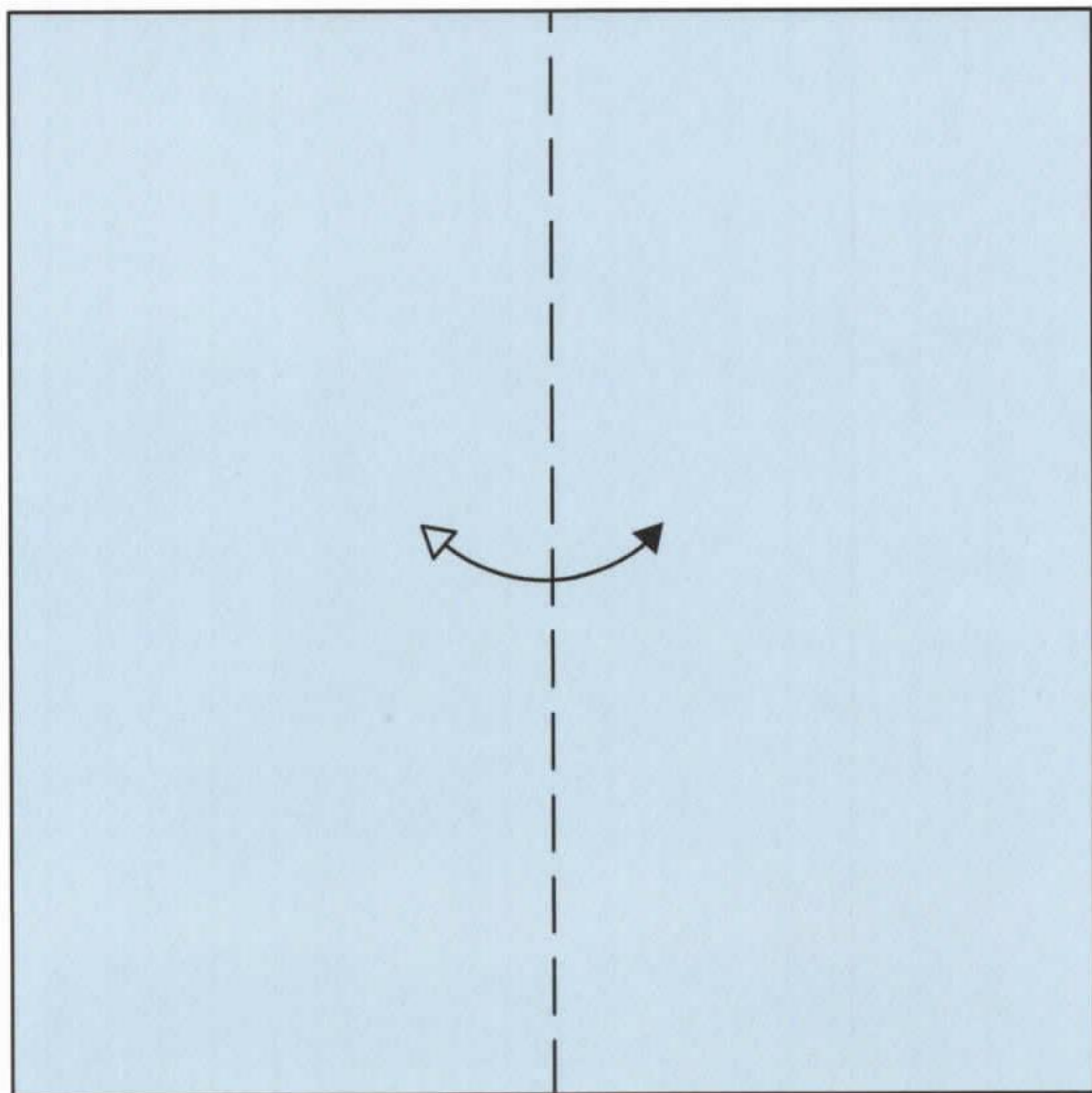

1. Valley fold and unfold

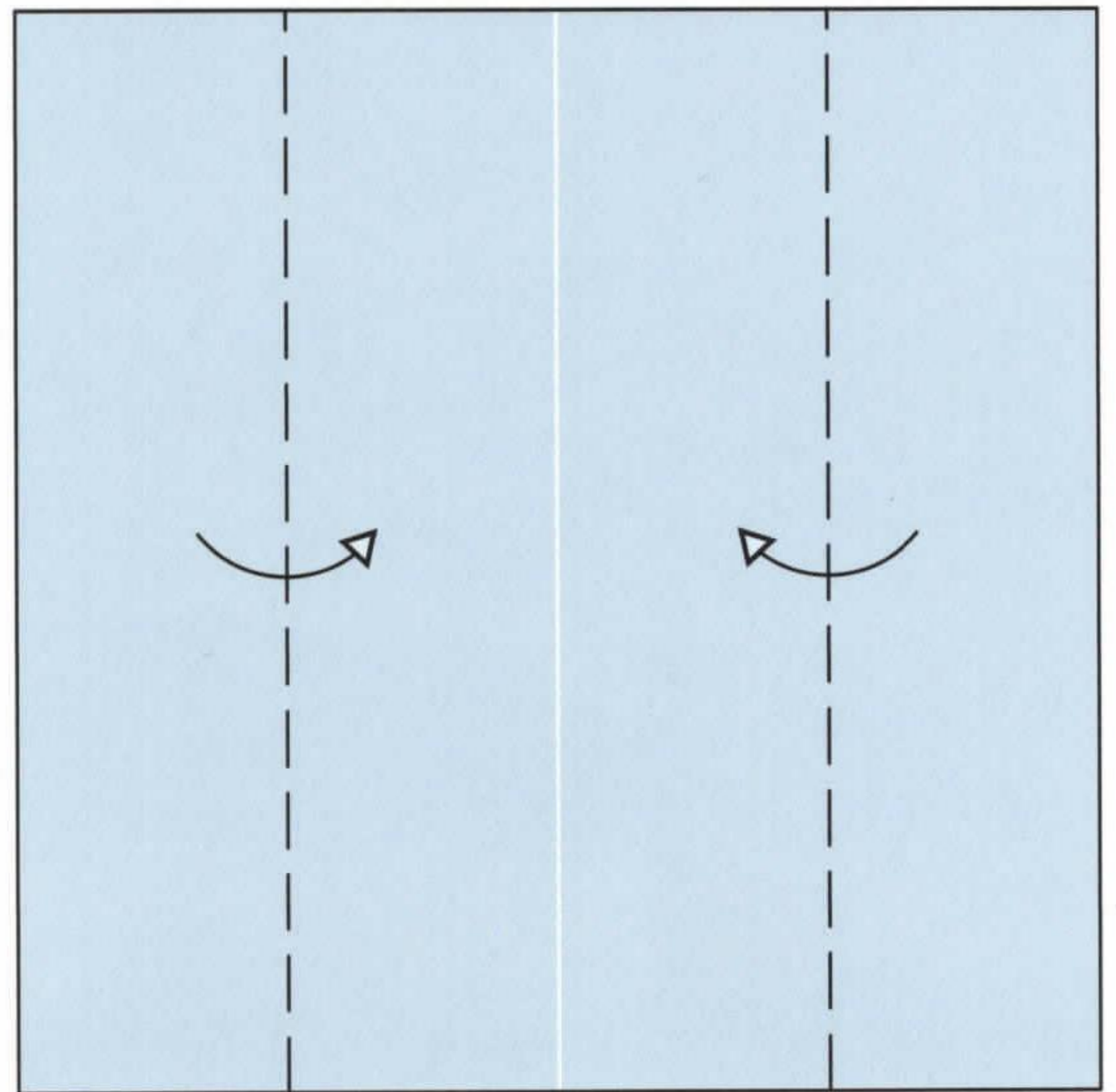

2. Valley folds

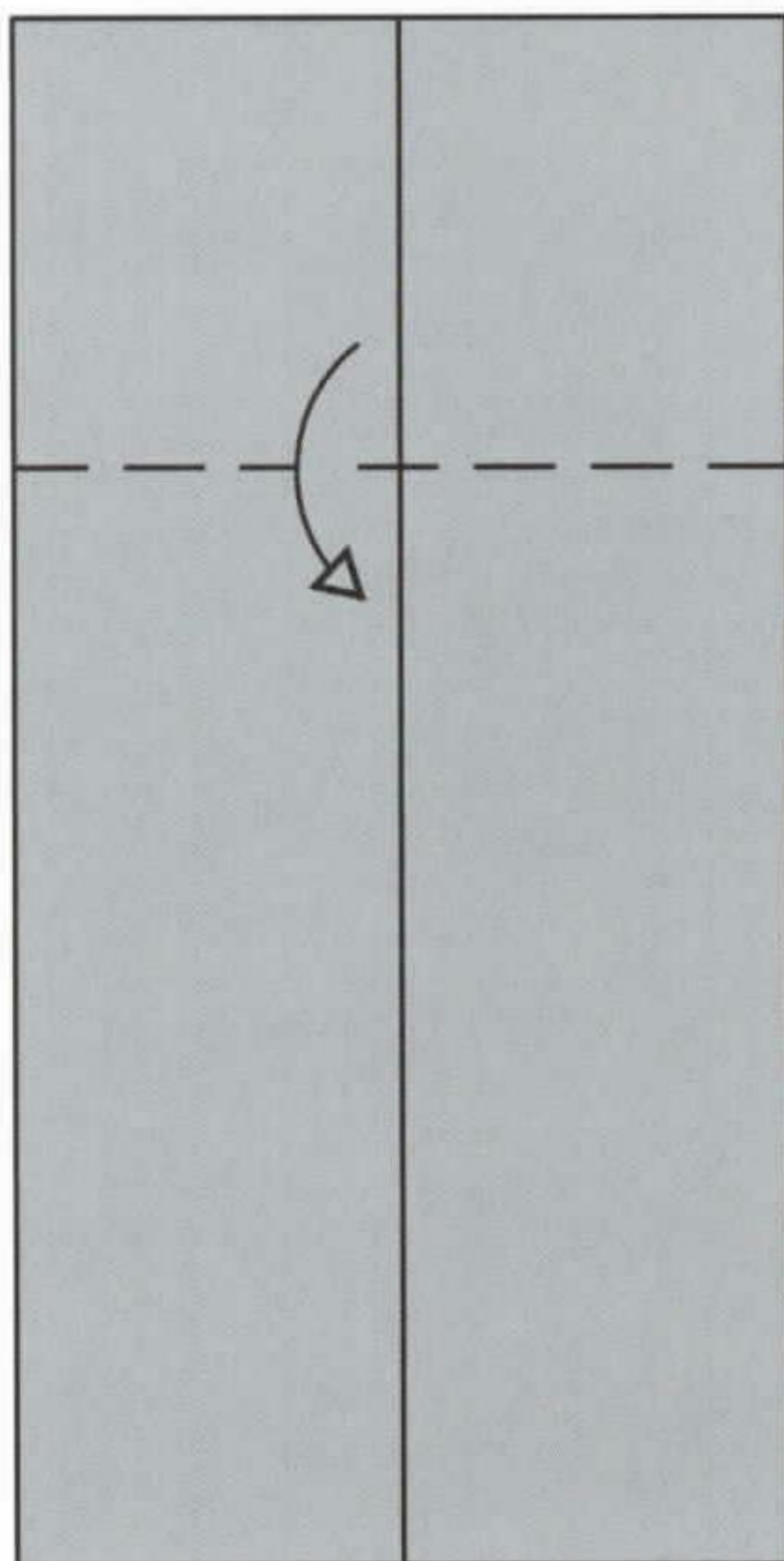

3. Valley fold

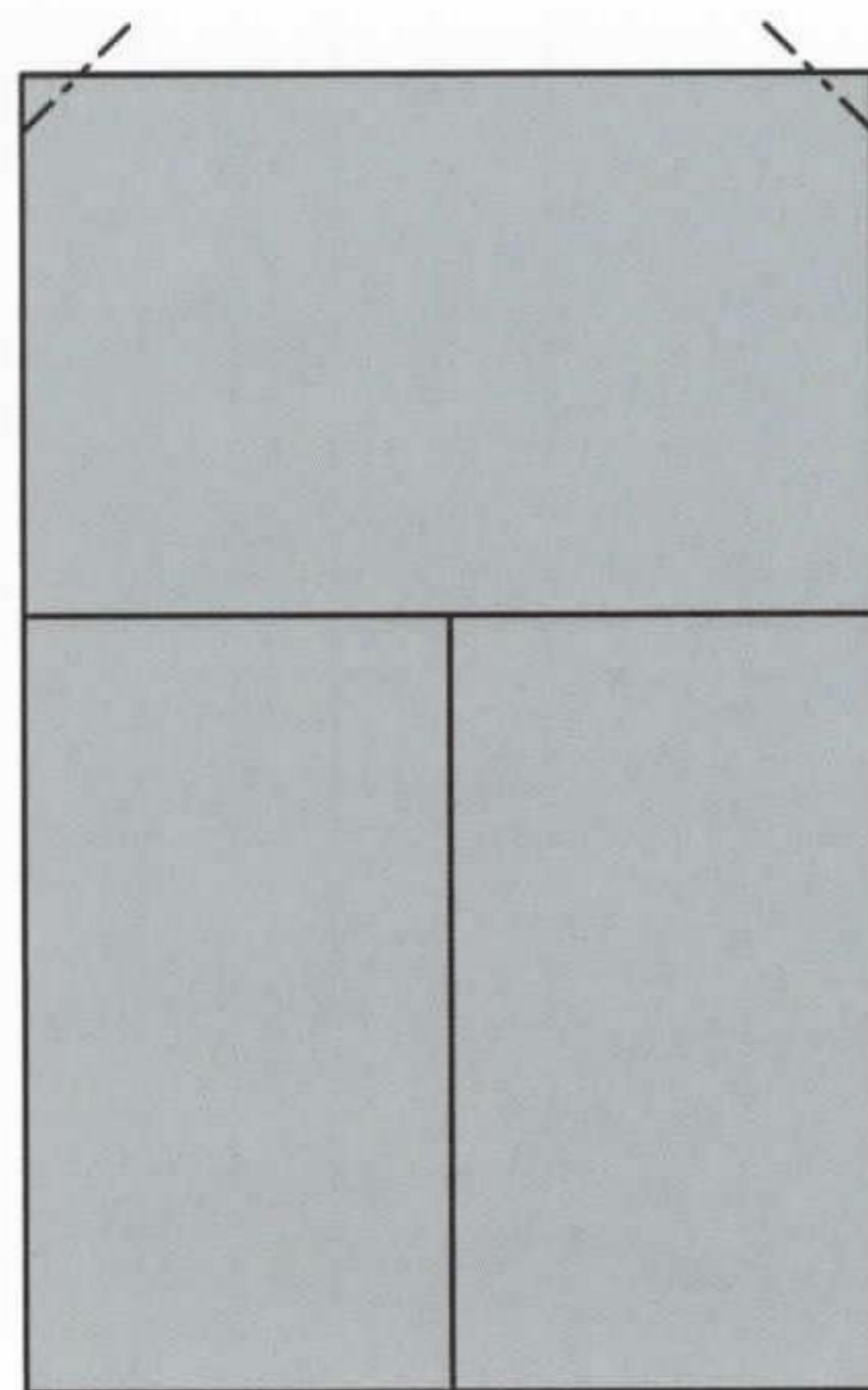

4. Inside reverse folds

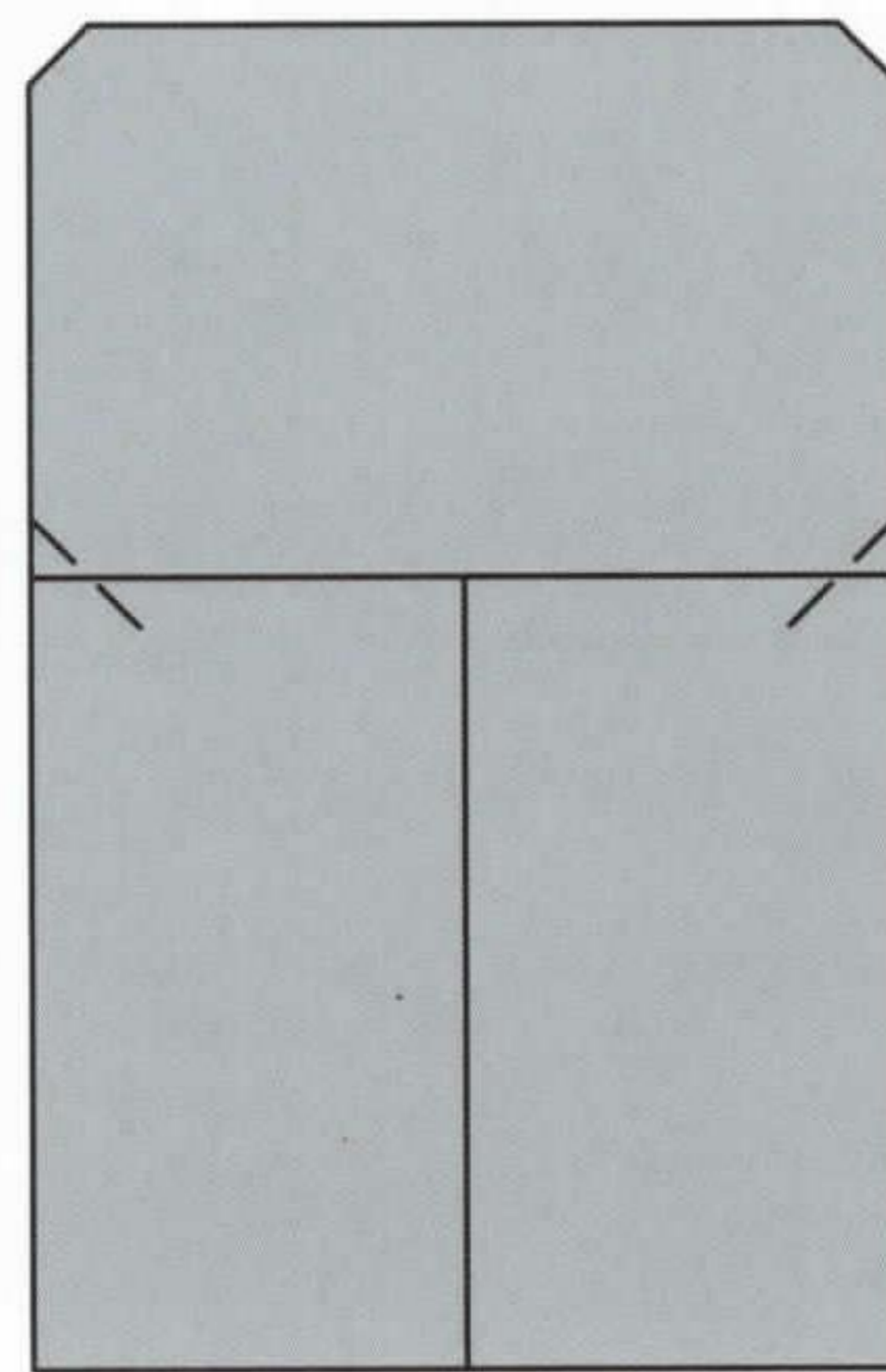

5. Valley folds

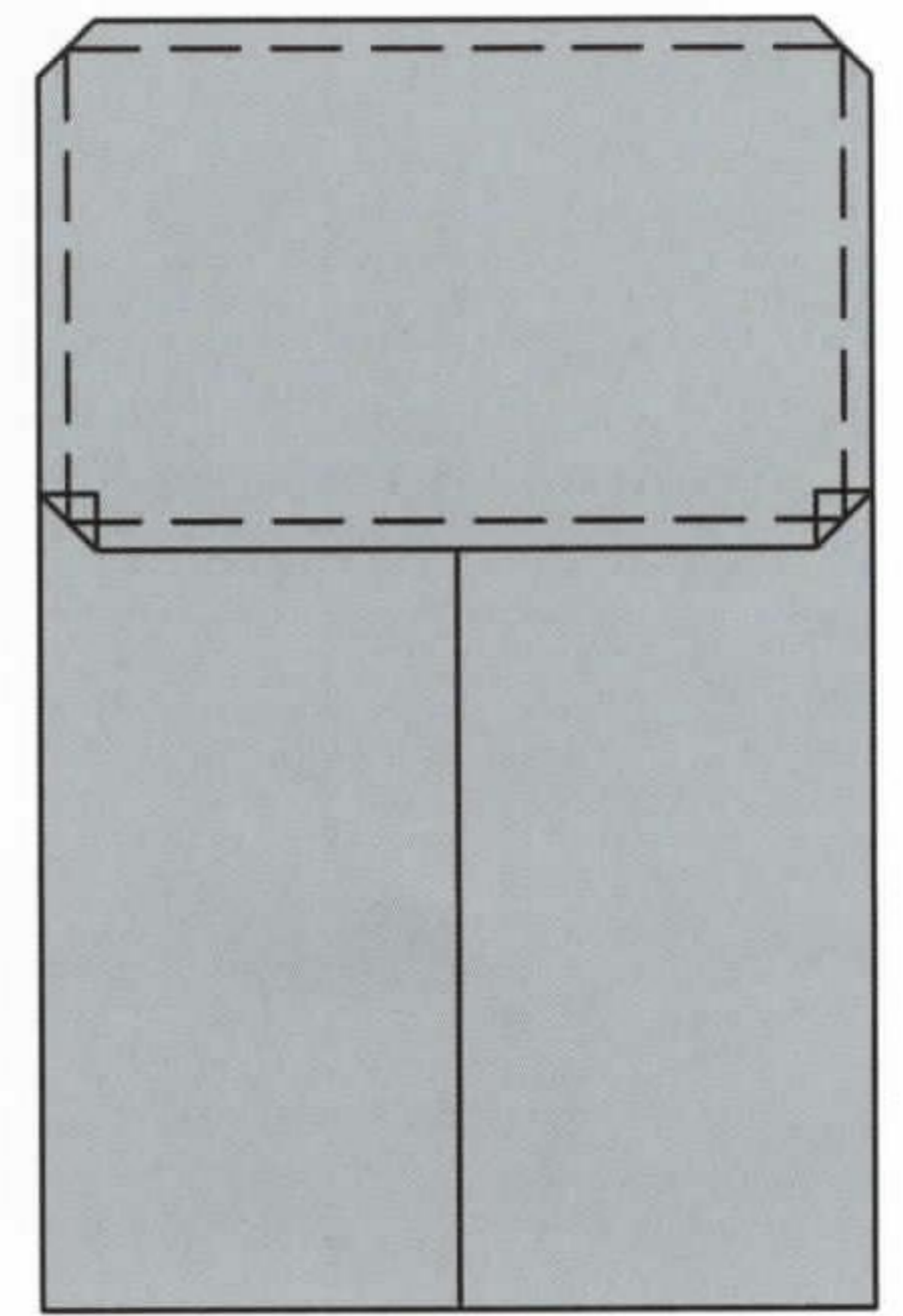

6. Valley folds

television: part 1

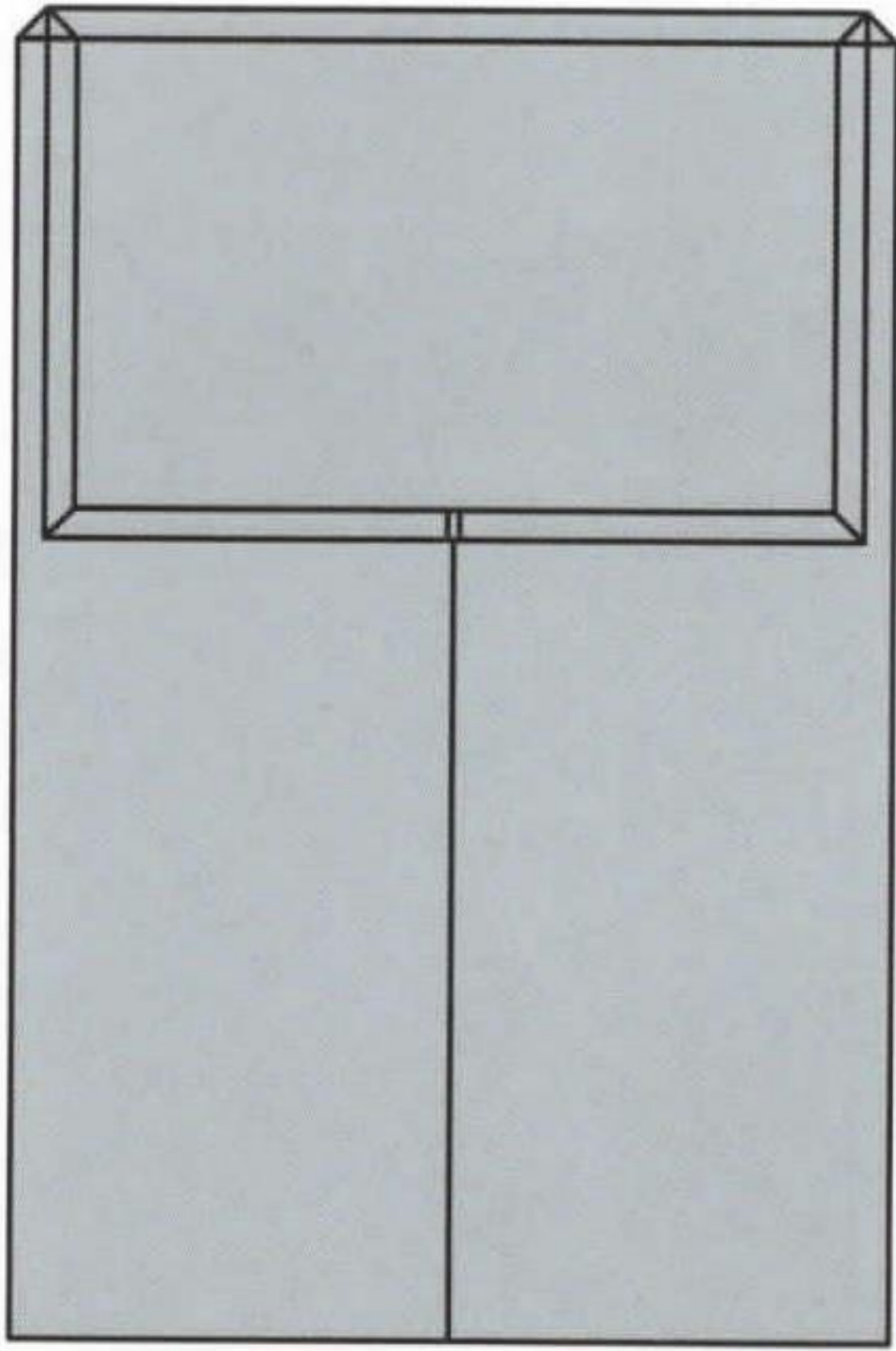

7. Rotate

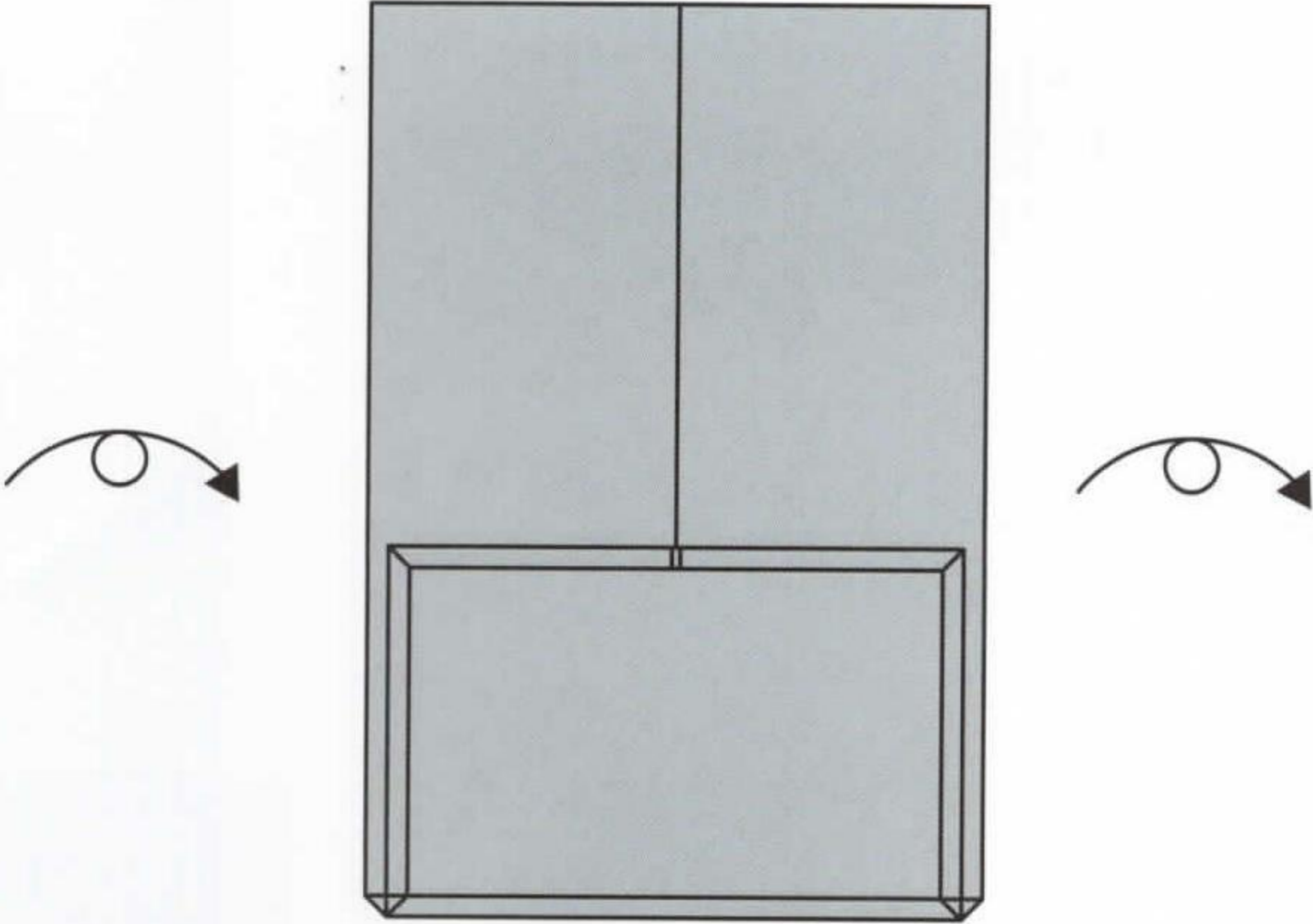

8. Turn over

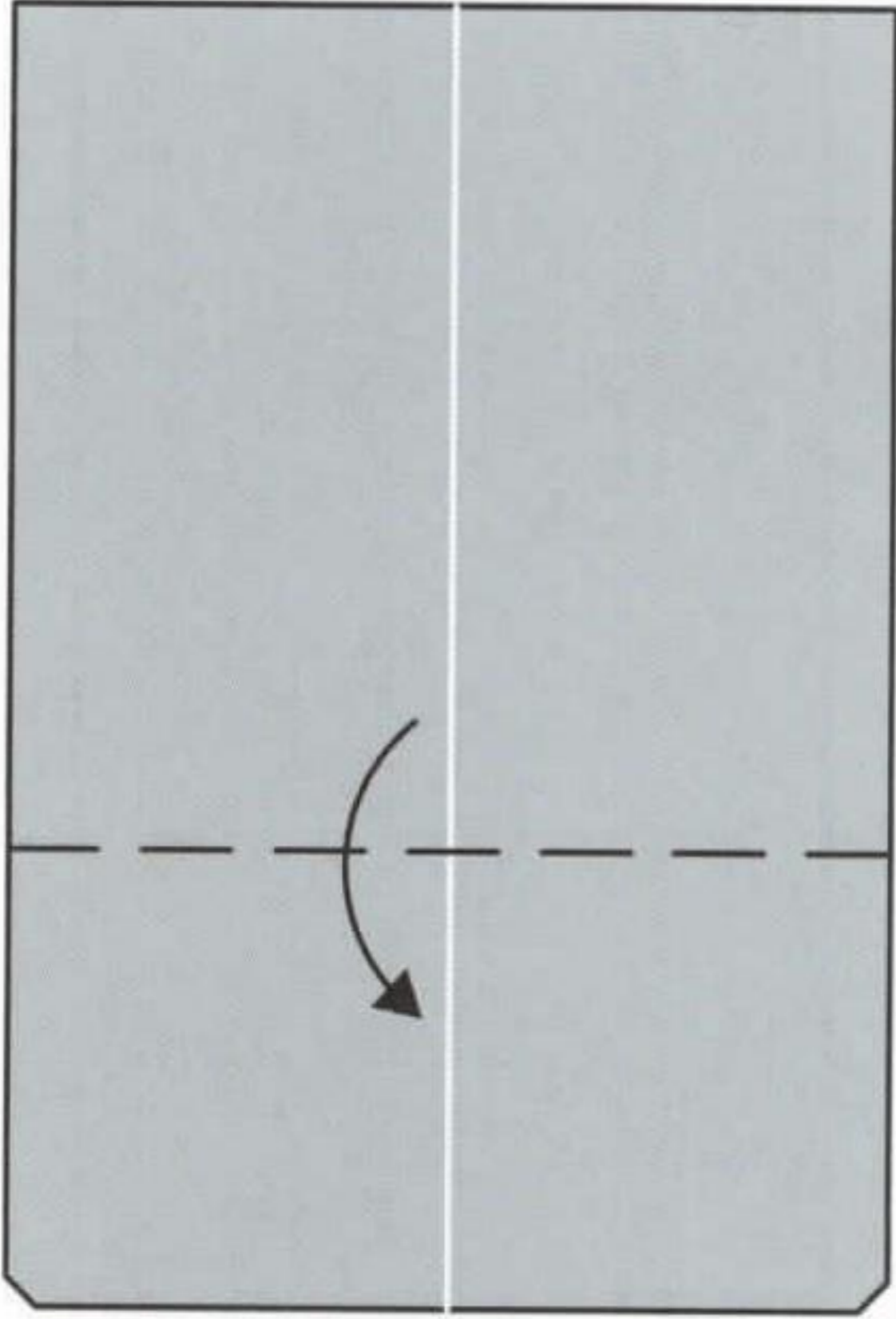

9. Valley fold

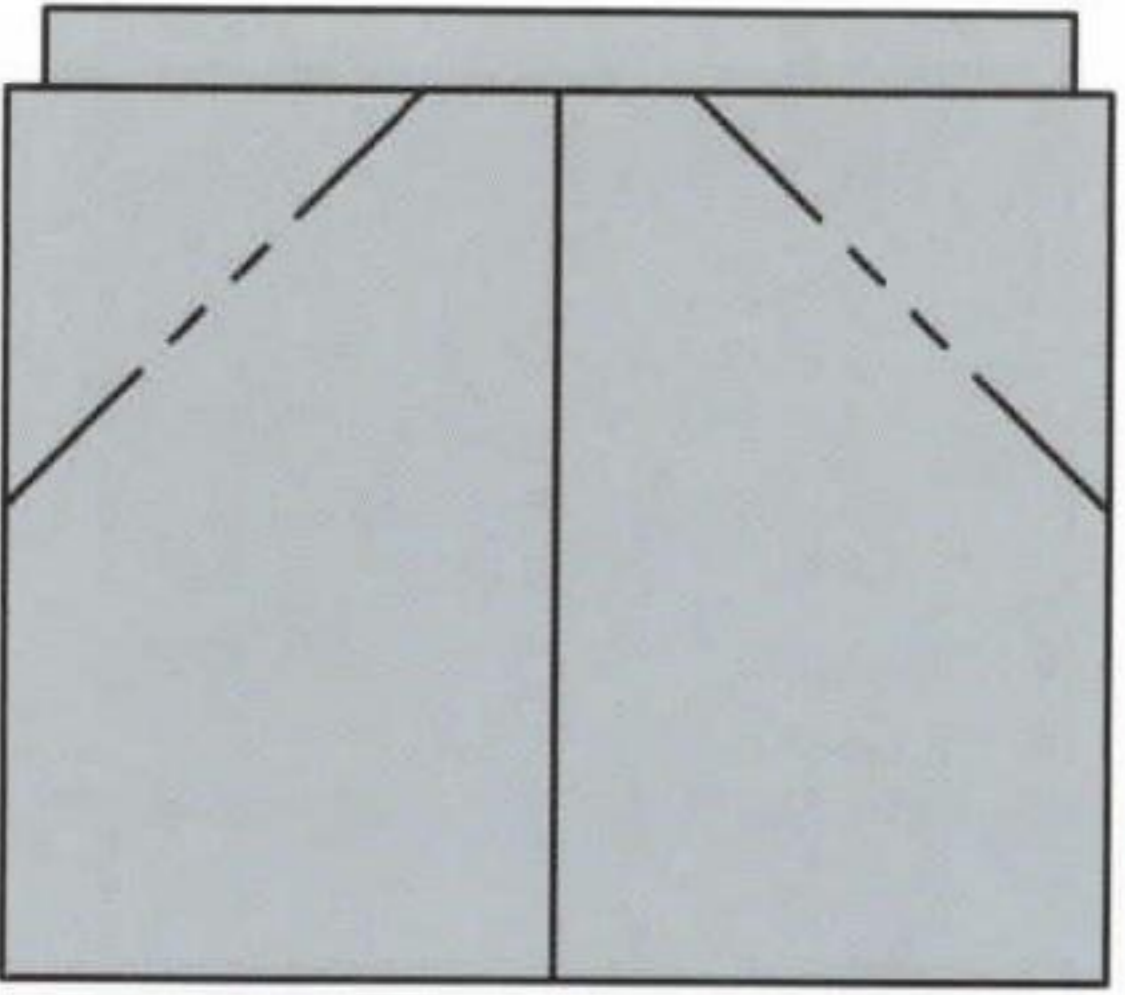

10. Inside reverse folds

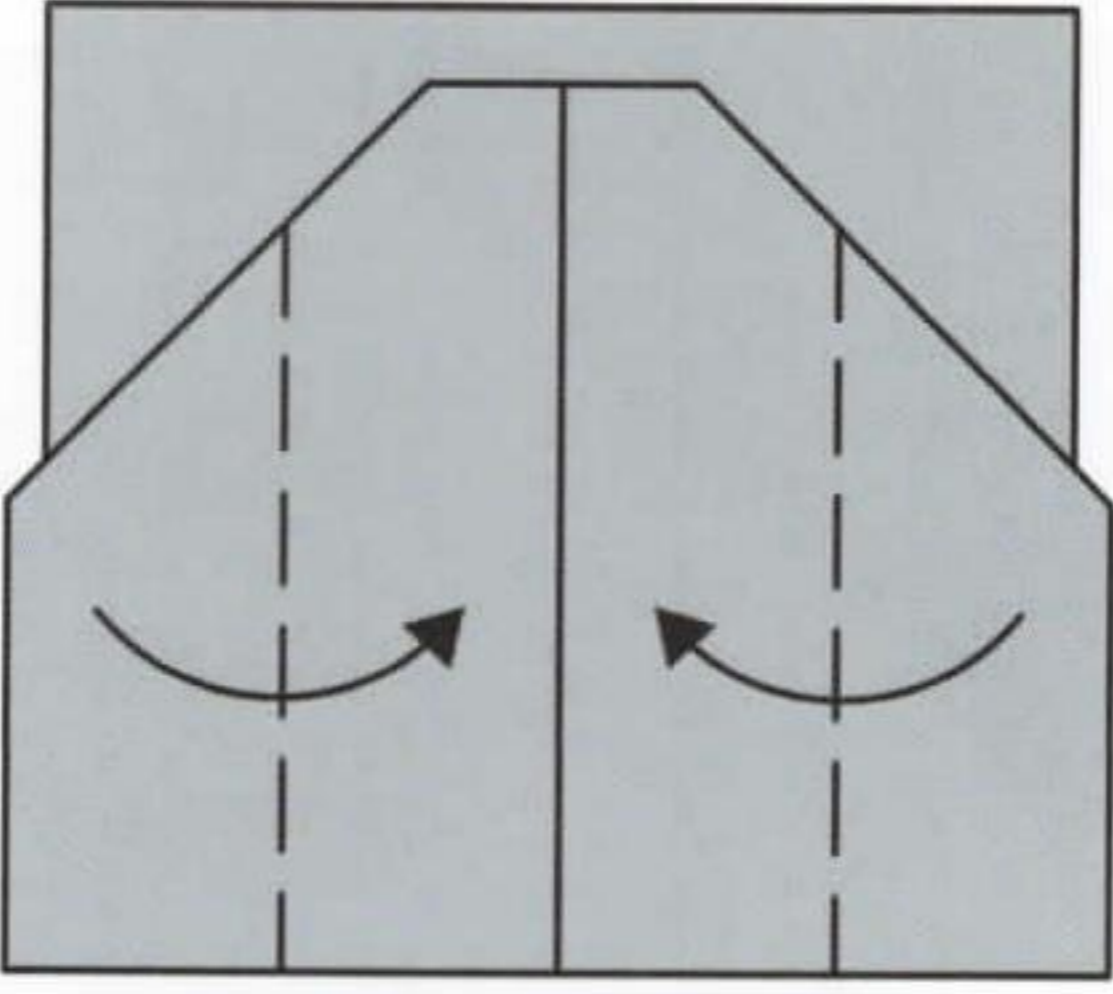

11. Valley folds

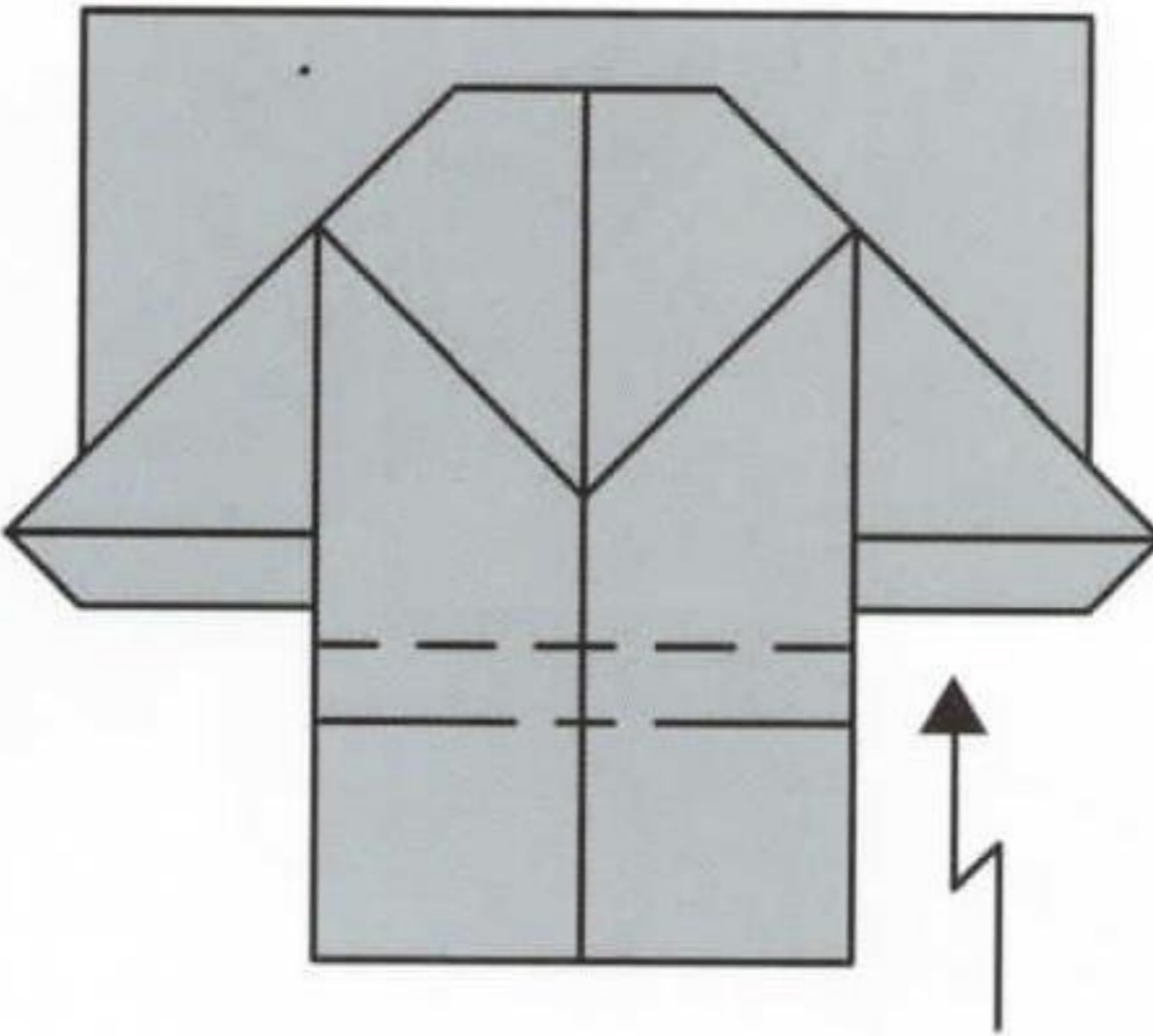

12. Pleat fold

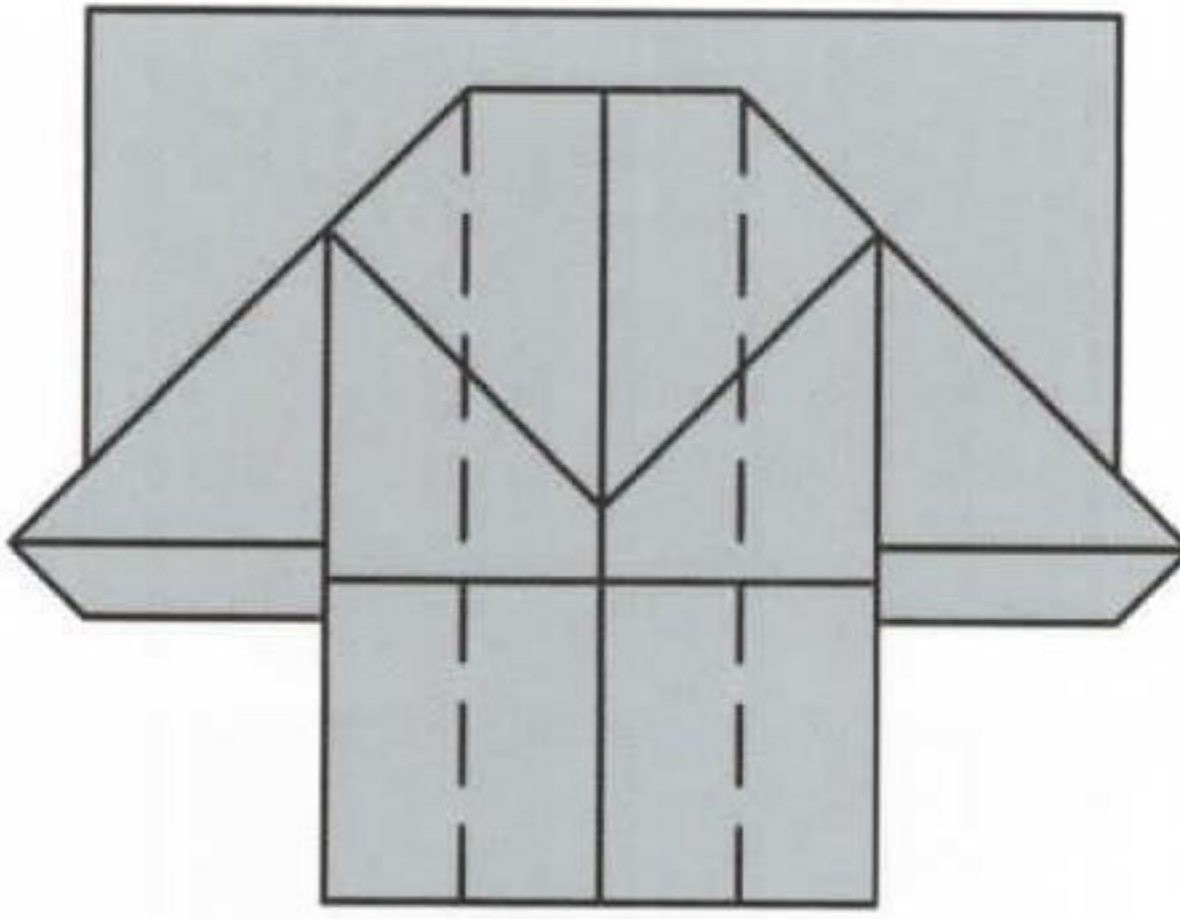

13. Valley folds

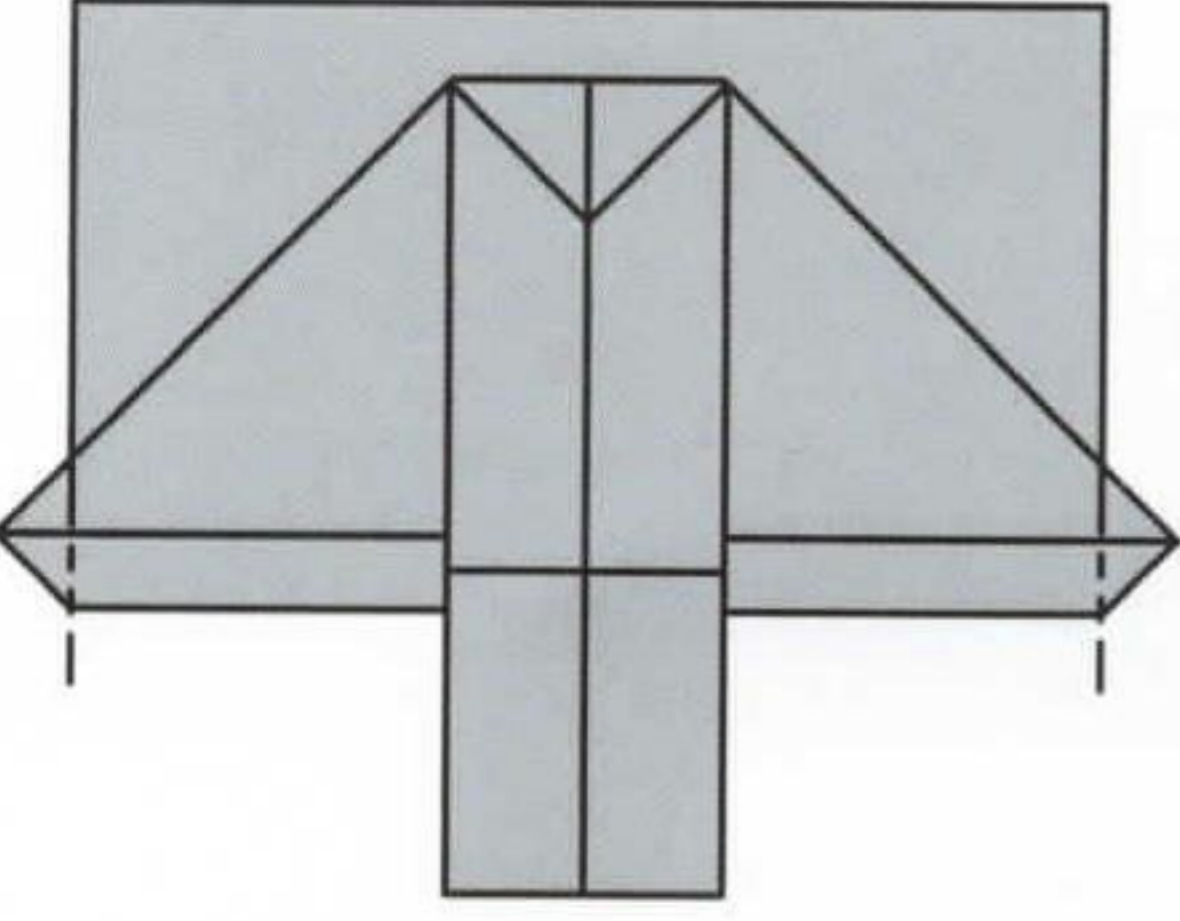

14. Inside reverse folds

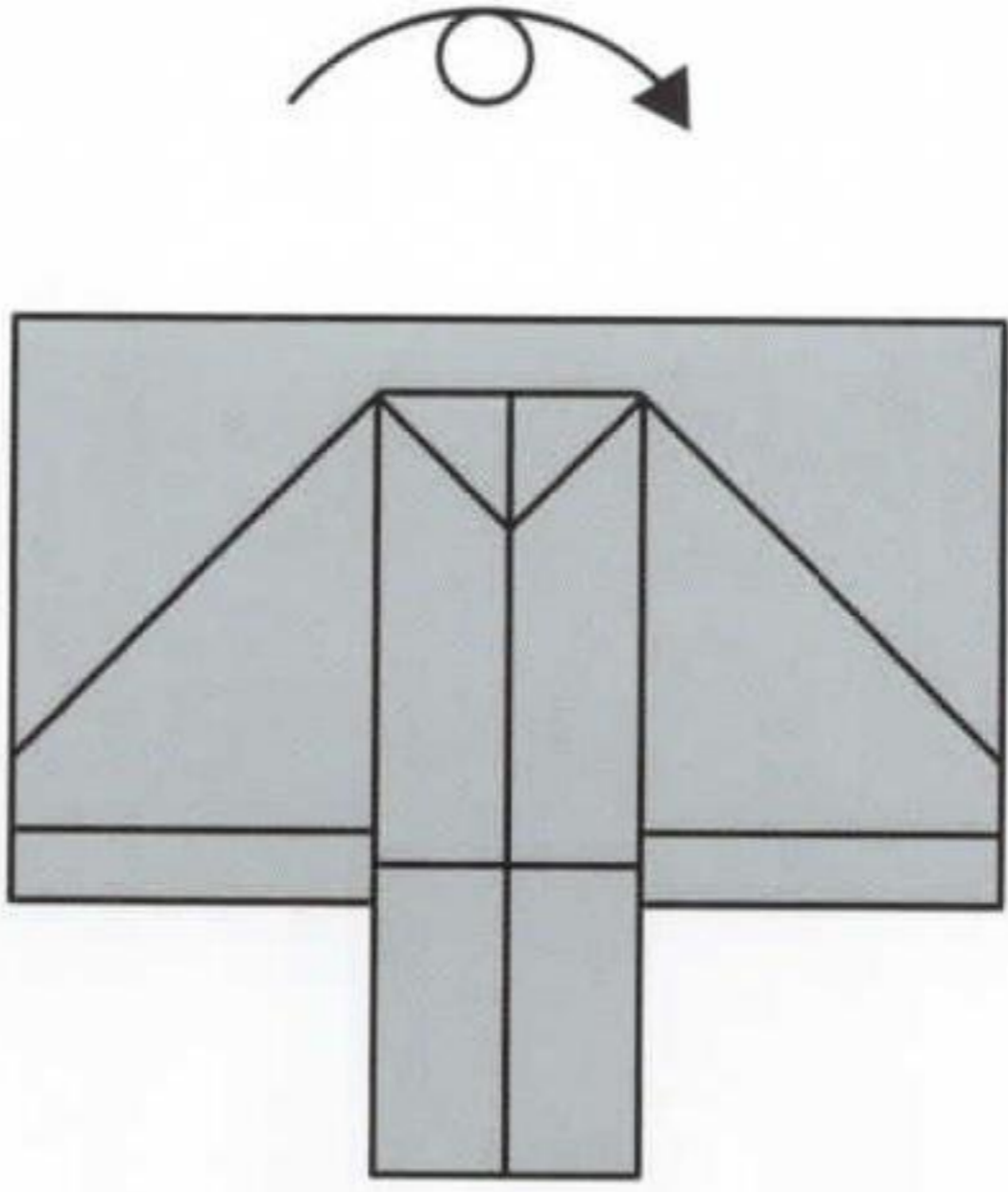

15. Turn over

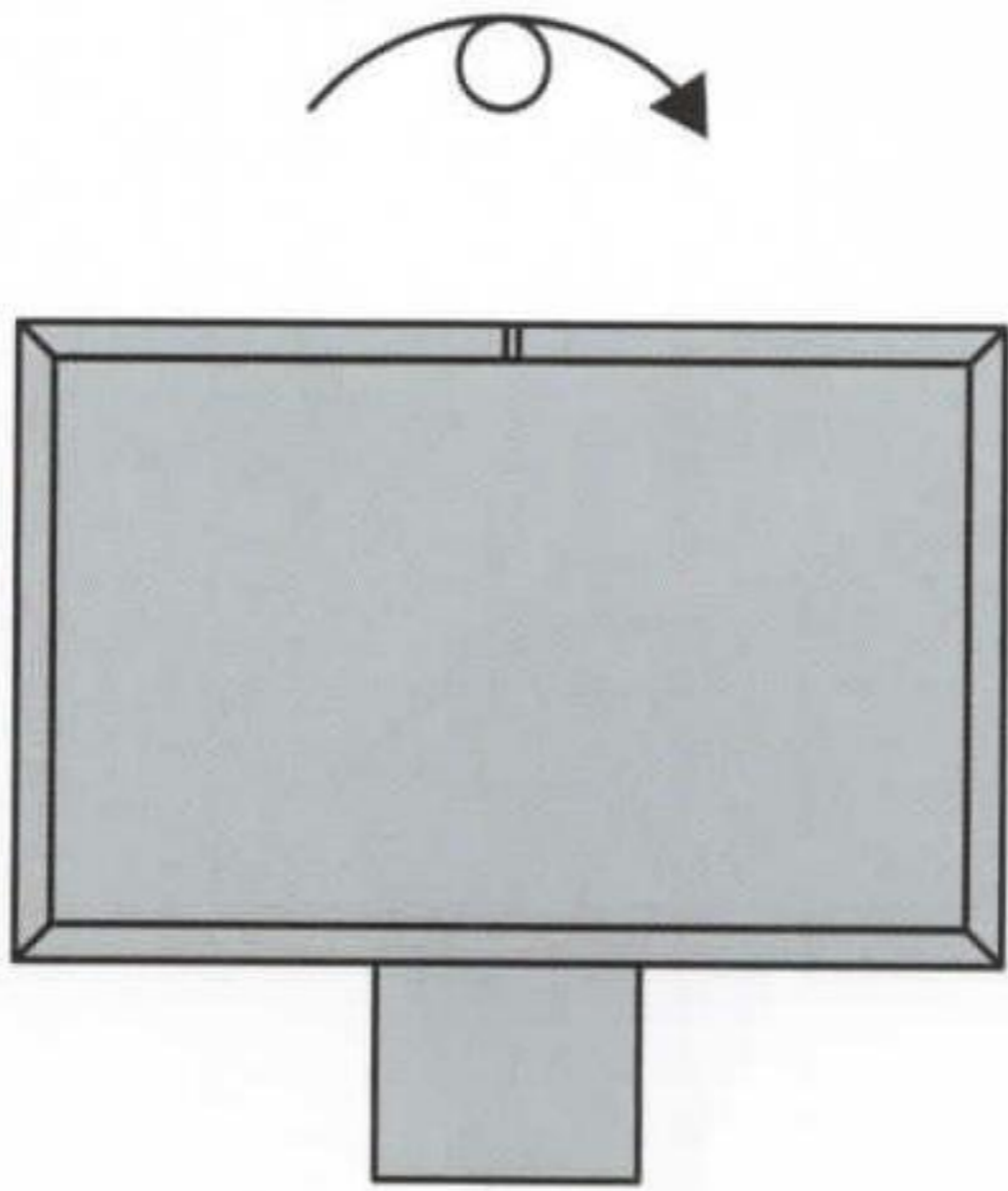

16. Rotate

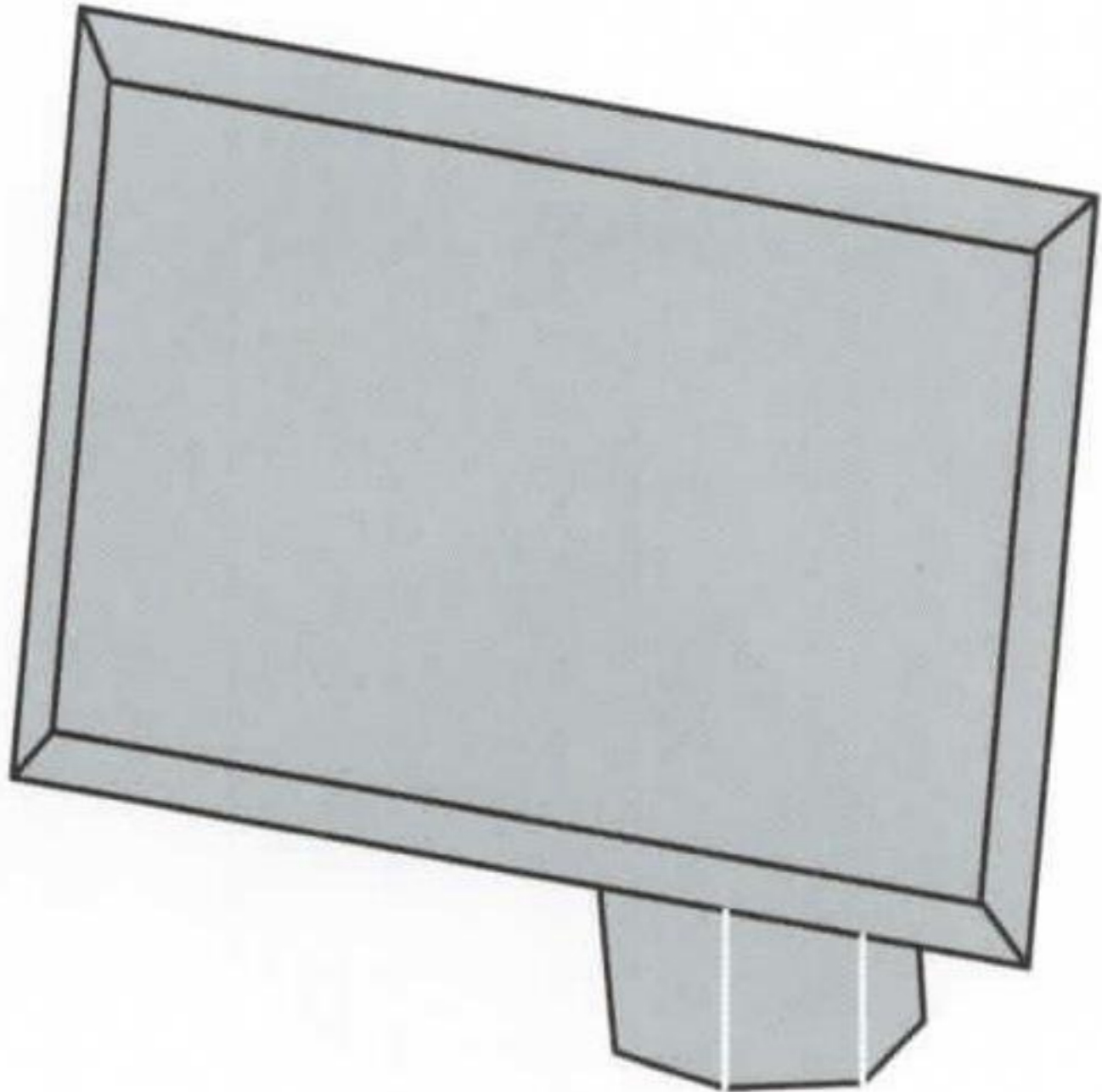

17. Completed PART 1

television: part 2

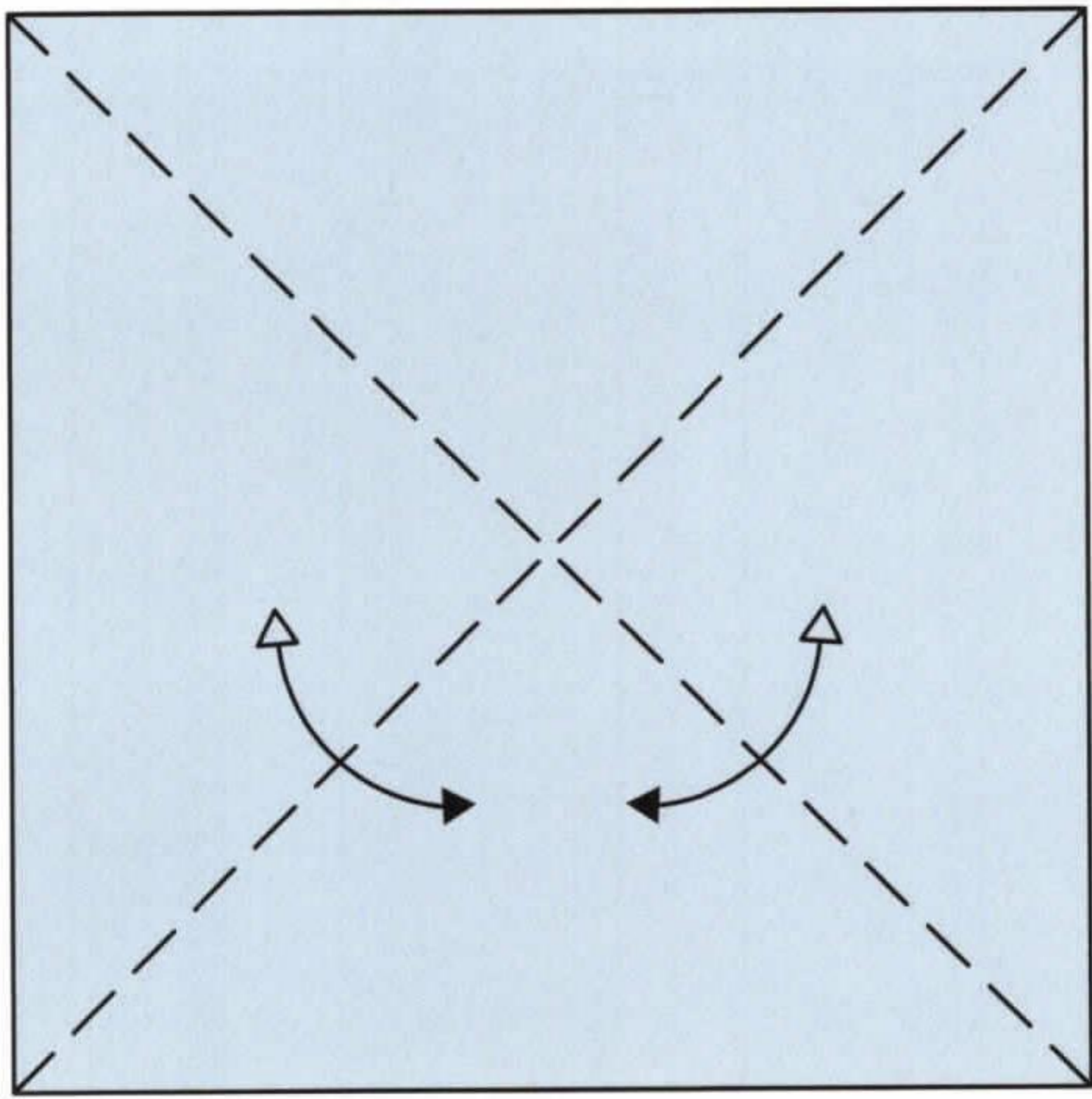

1. Valley fold and unfold

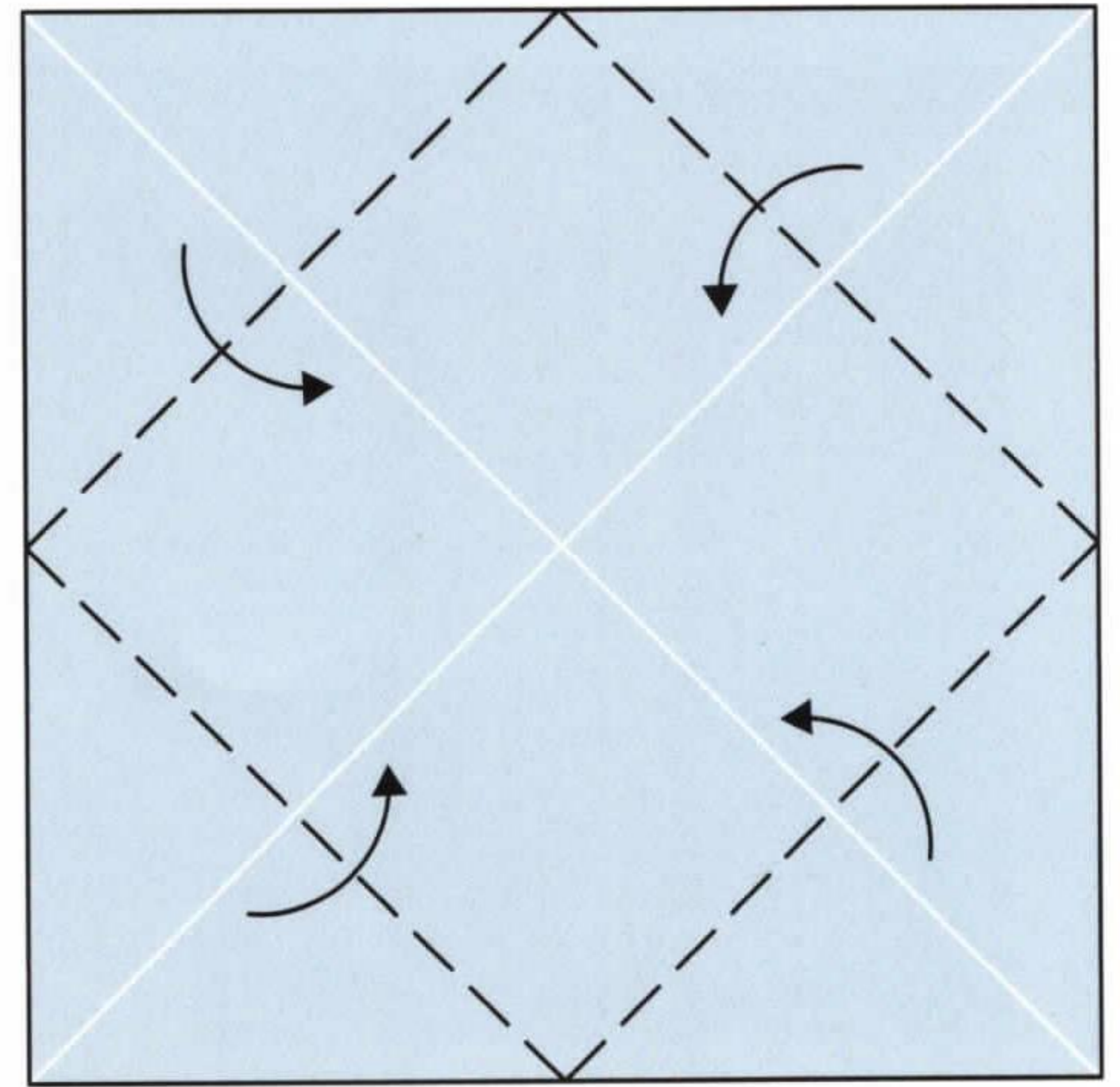

2. Valley folds

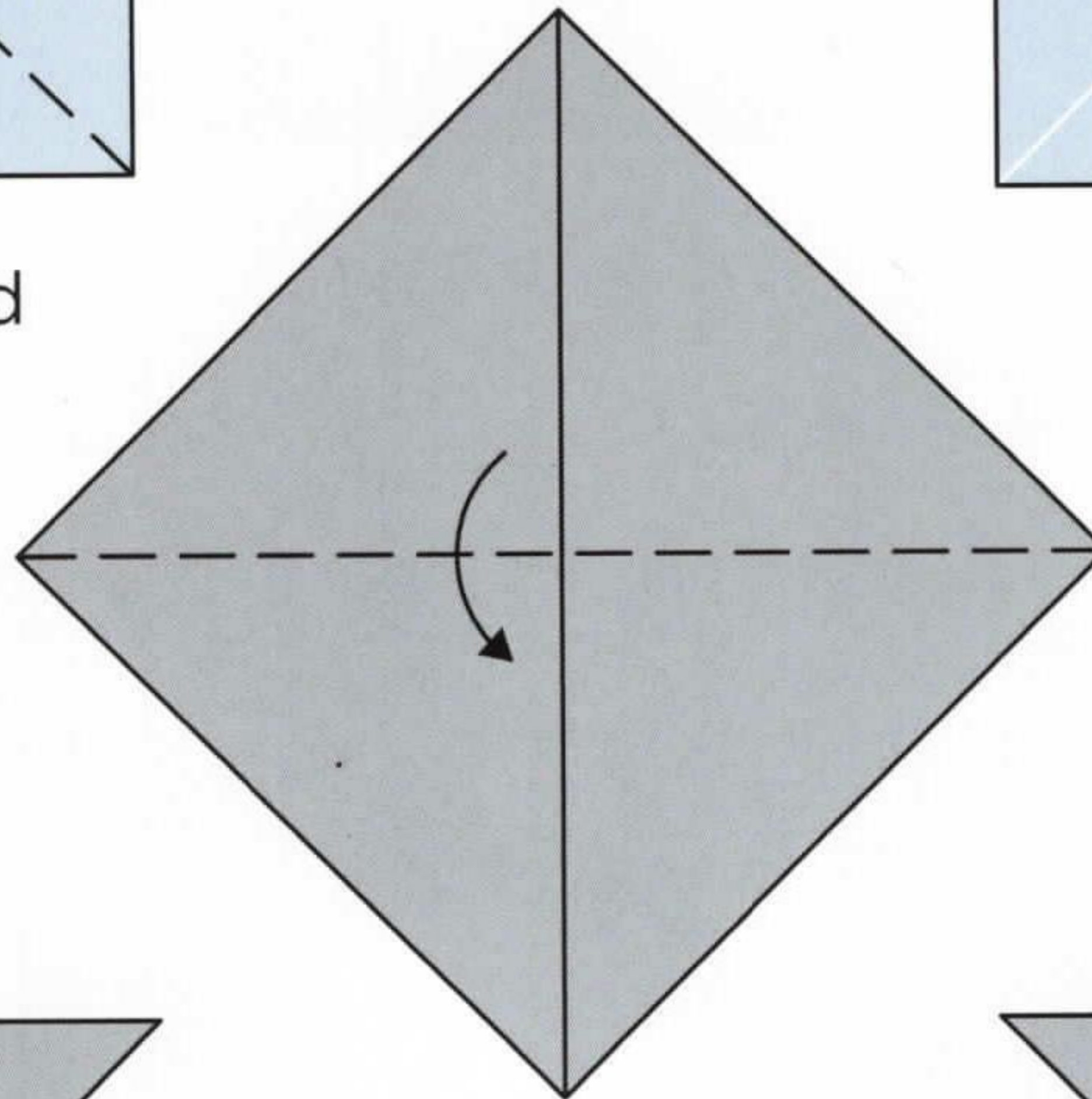

3. Valley fold

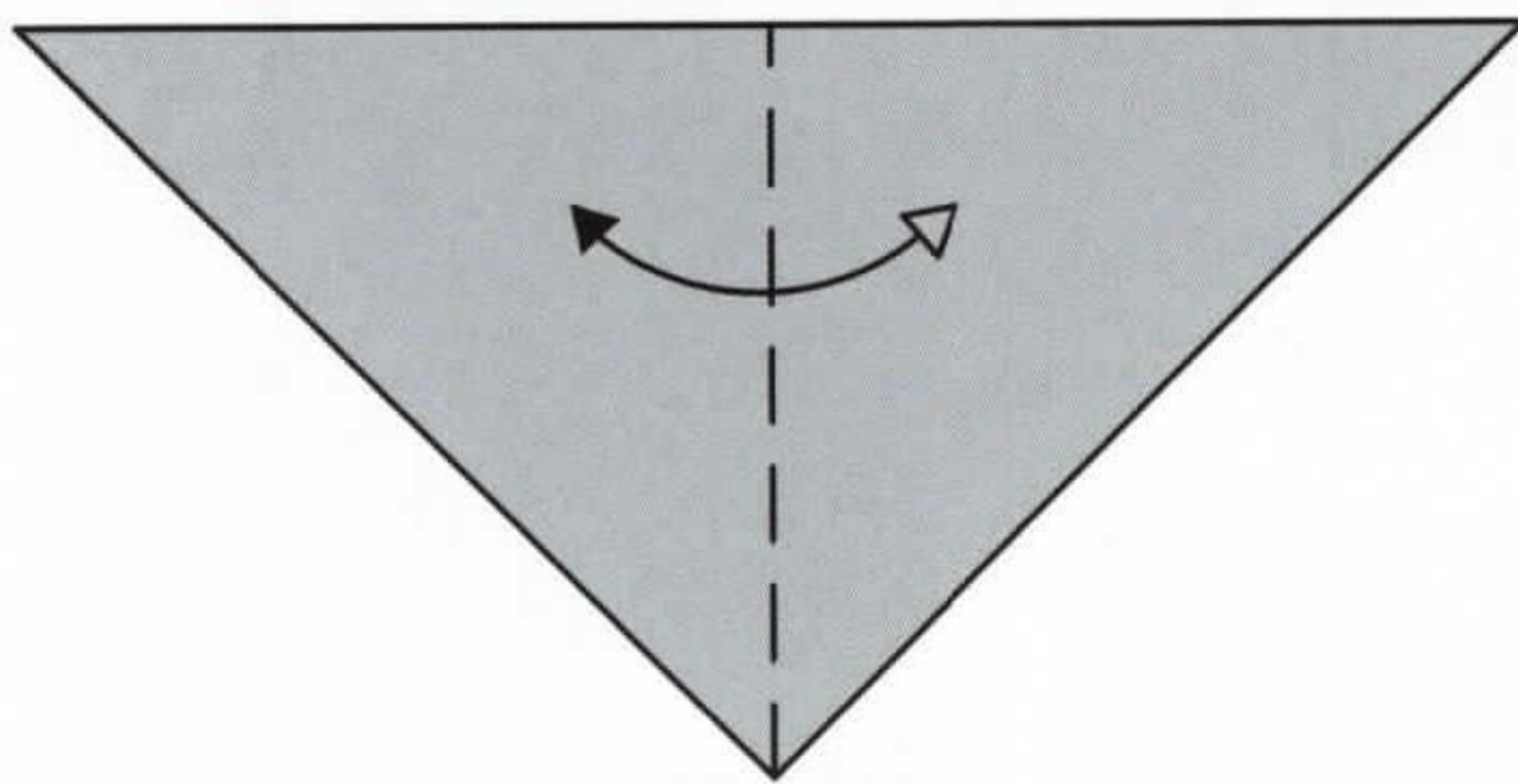

4. Valley fold and unfold

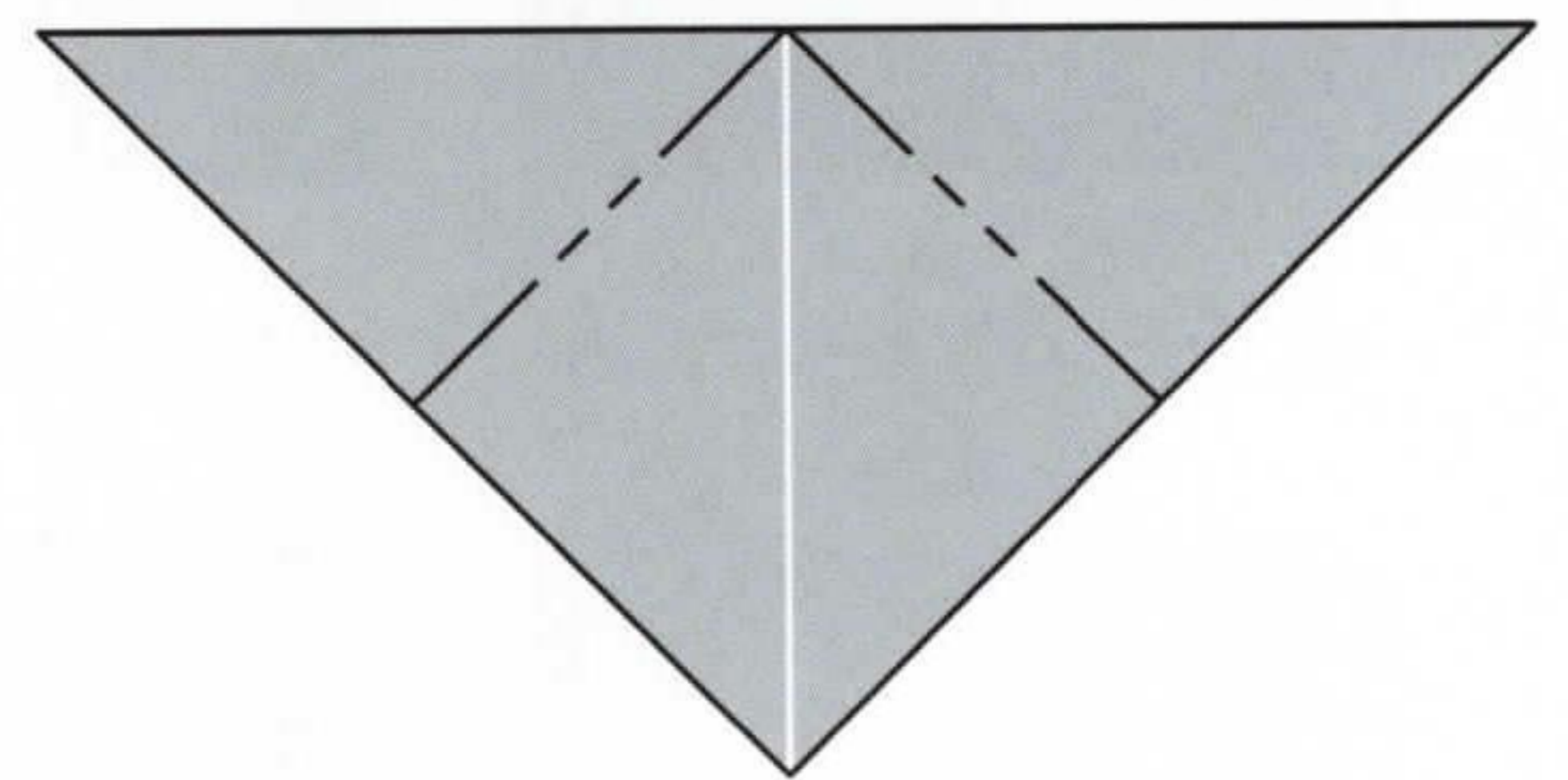

5. Inside reverse folds

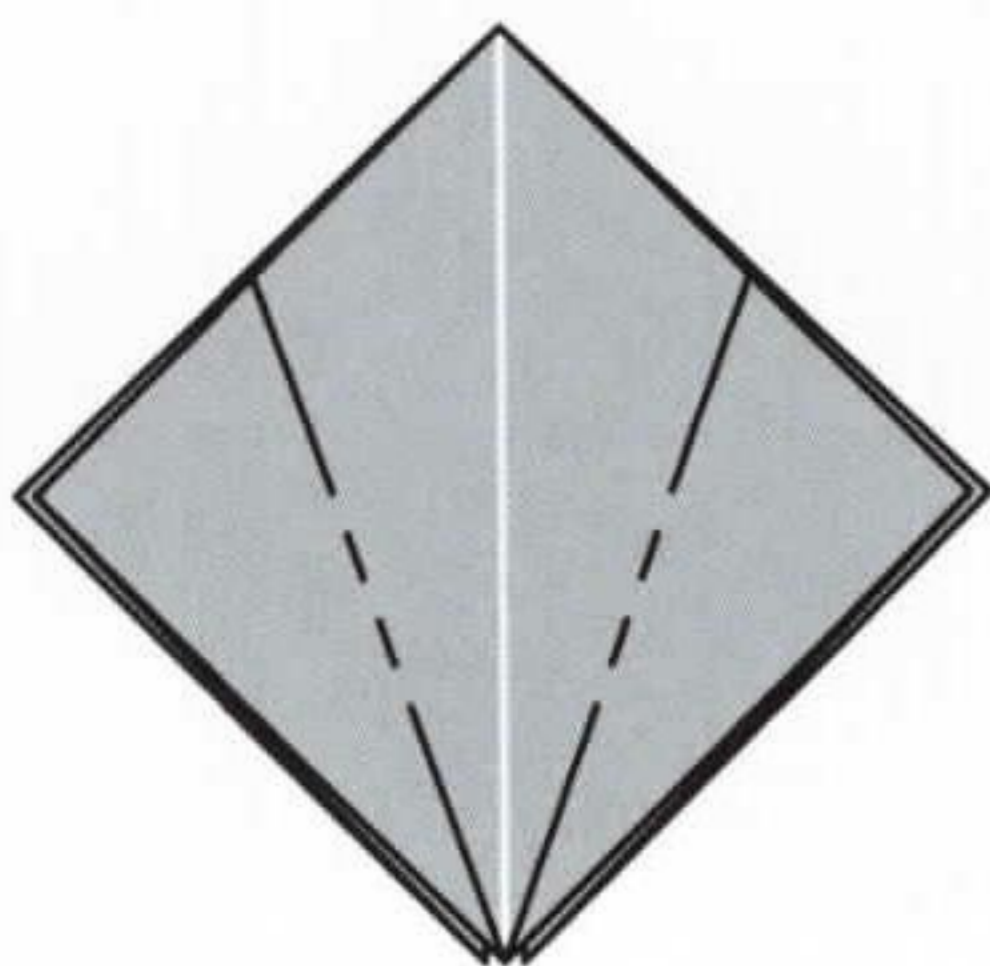

6. Inside reverse fold

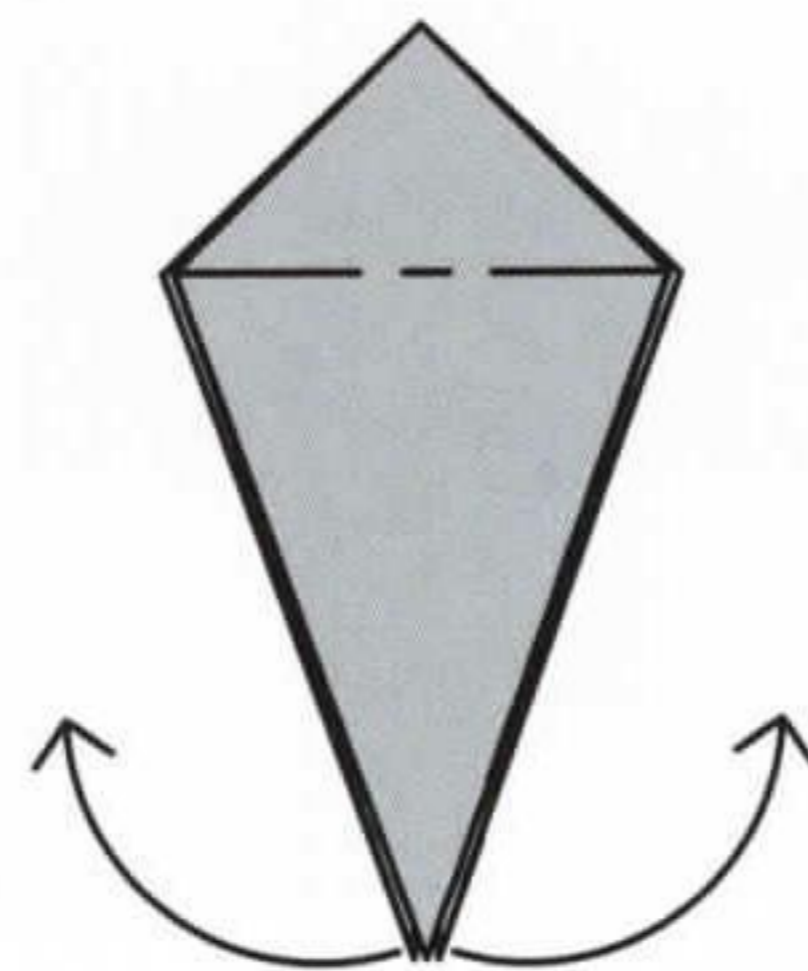

7. Pull and fold

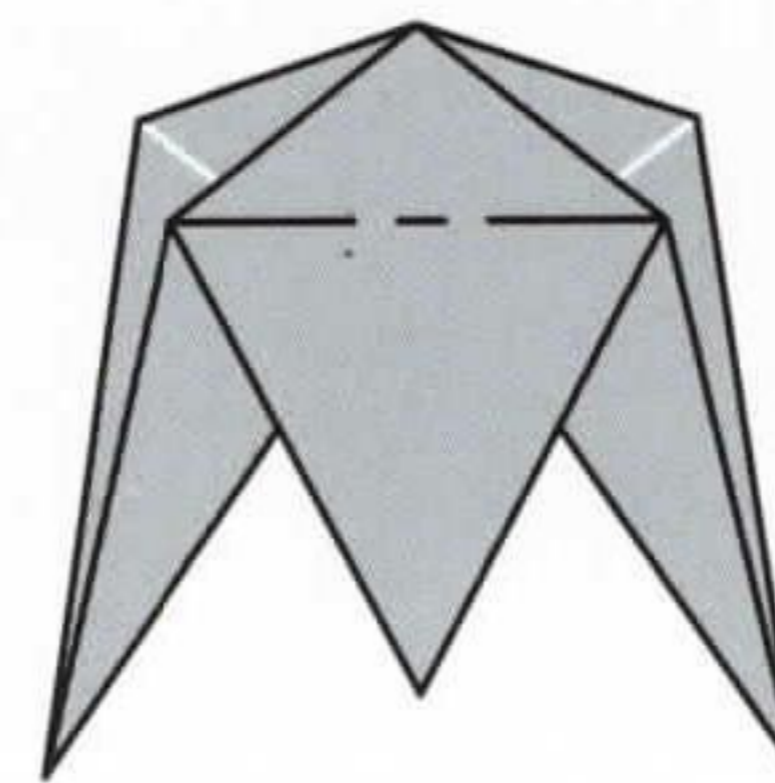

8. Before complete

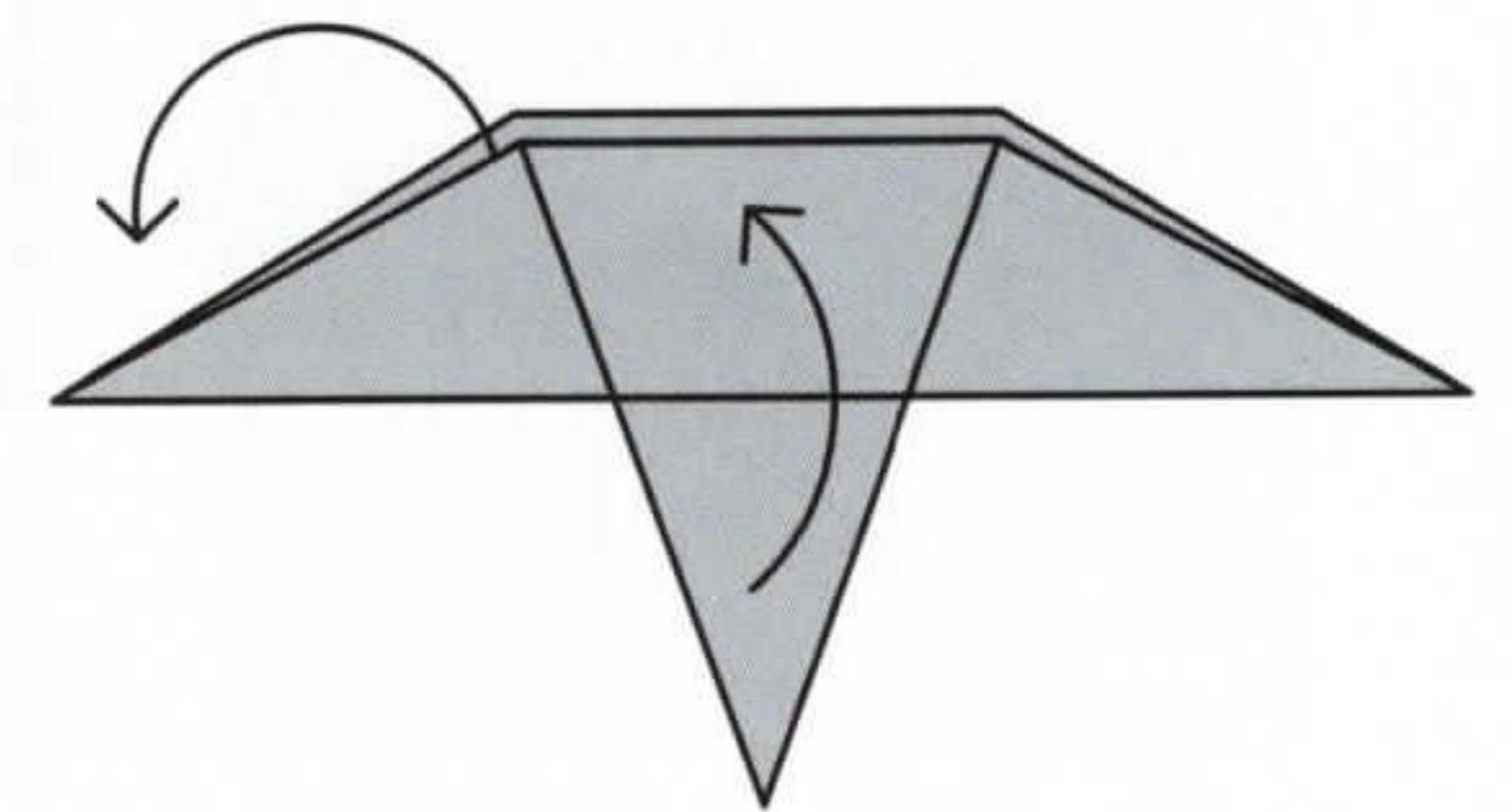

9. Open flaps

television: part 2

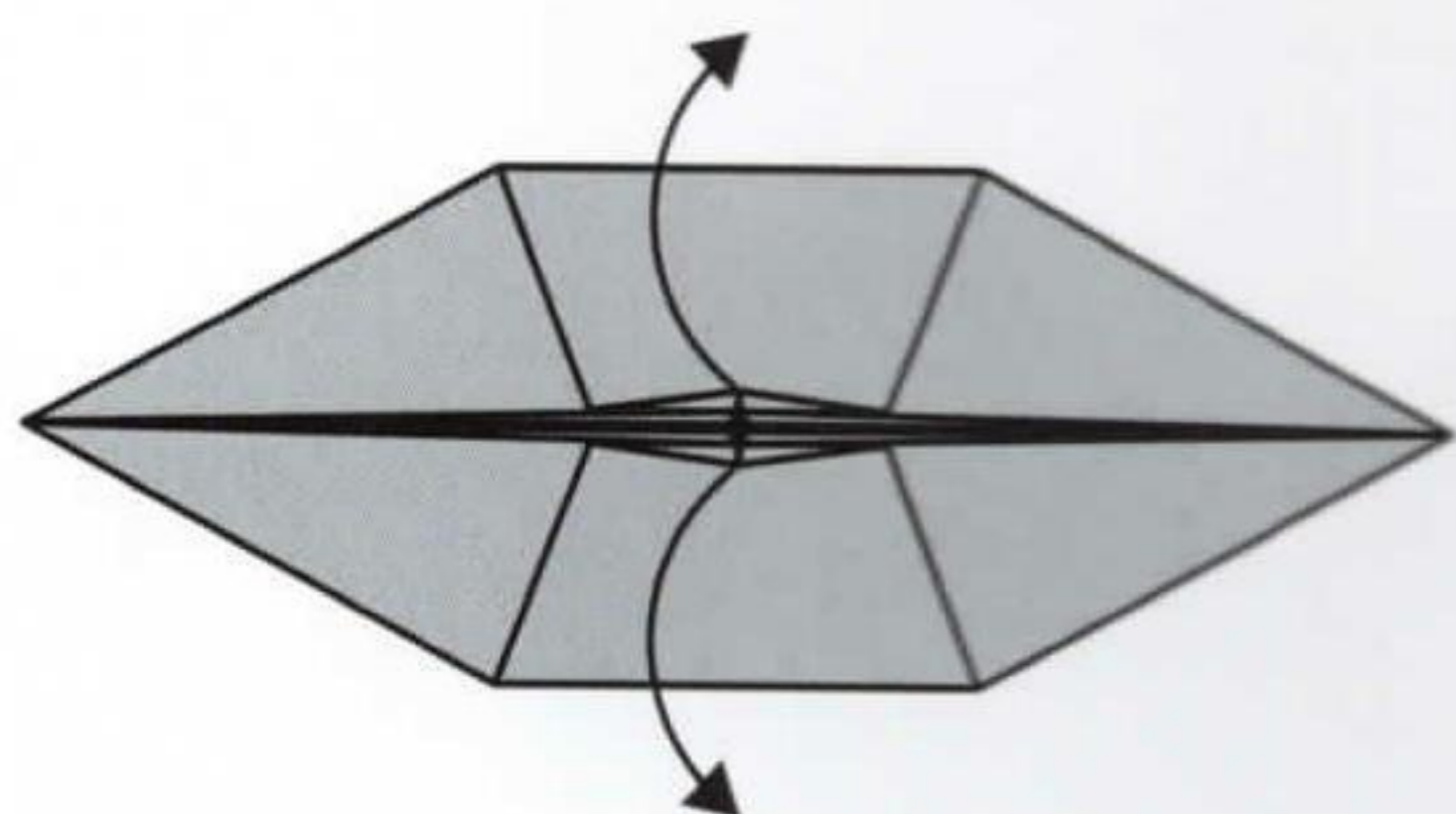

10. Valley folds

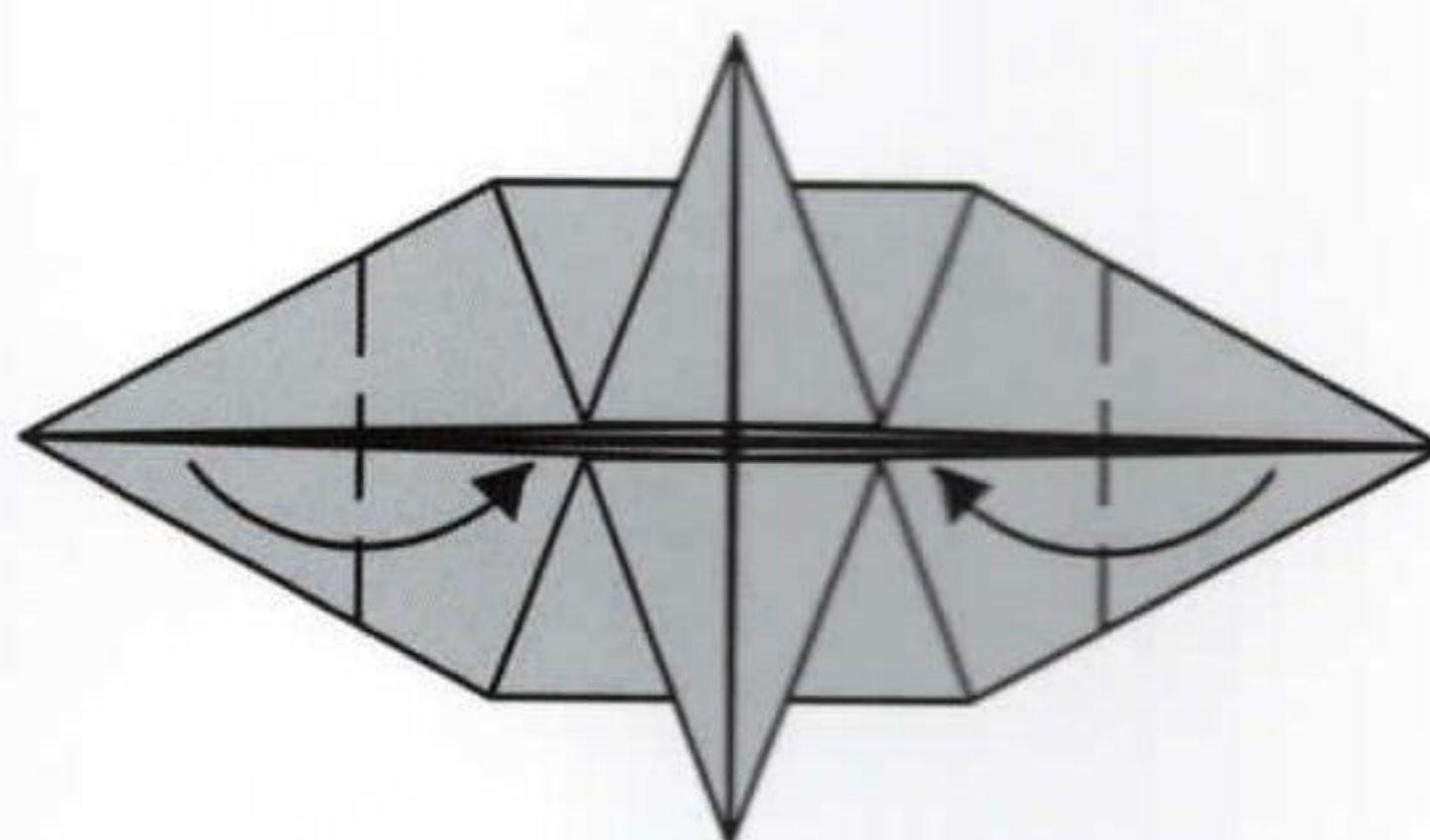

11. Valley folds

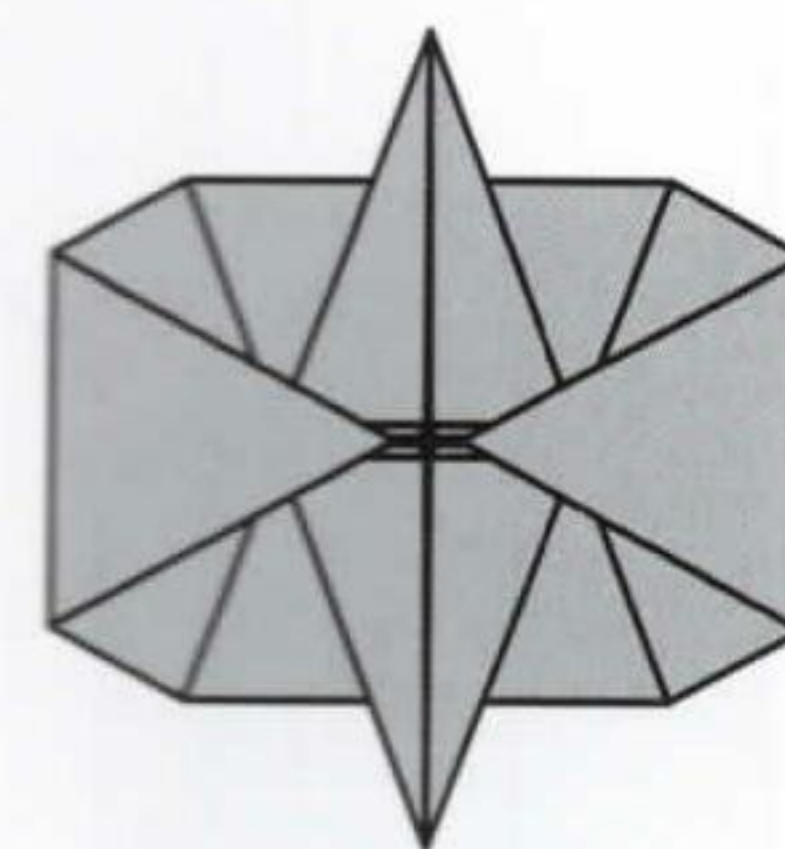

12. Hide behind

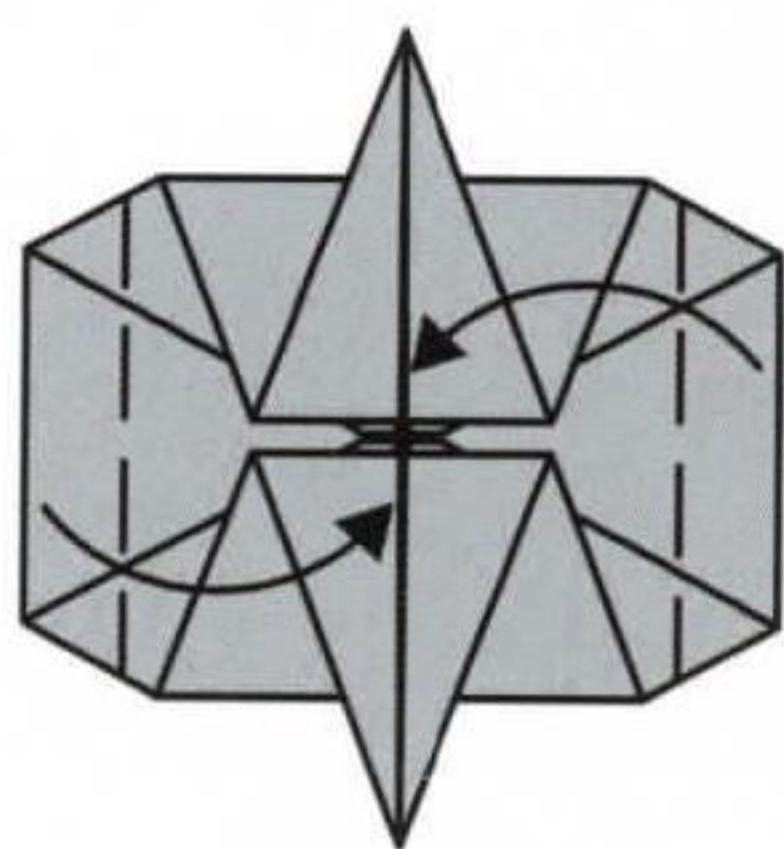

13. Valley folds

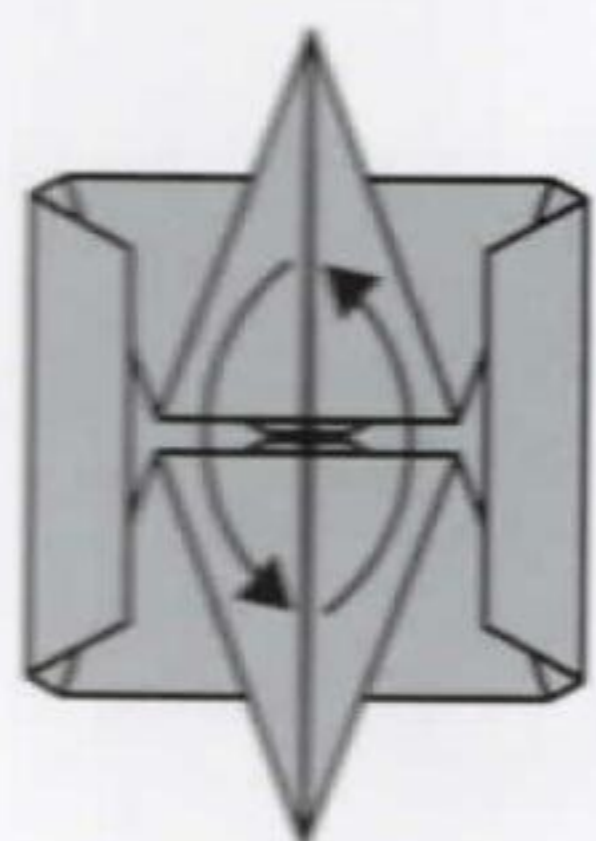

14. Valley folds

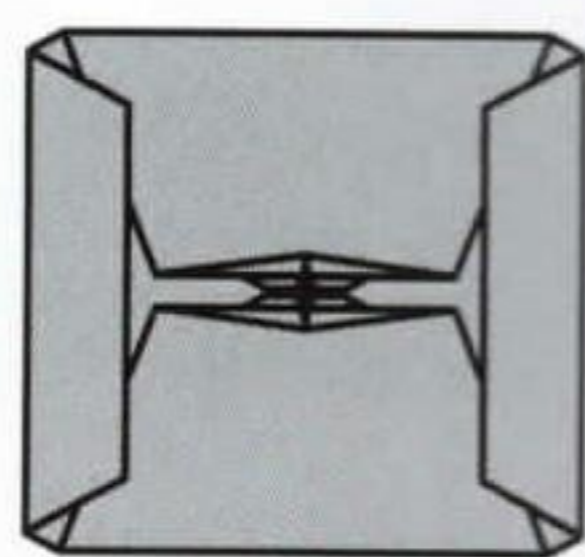

15. Rotate

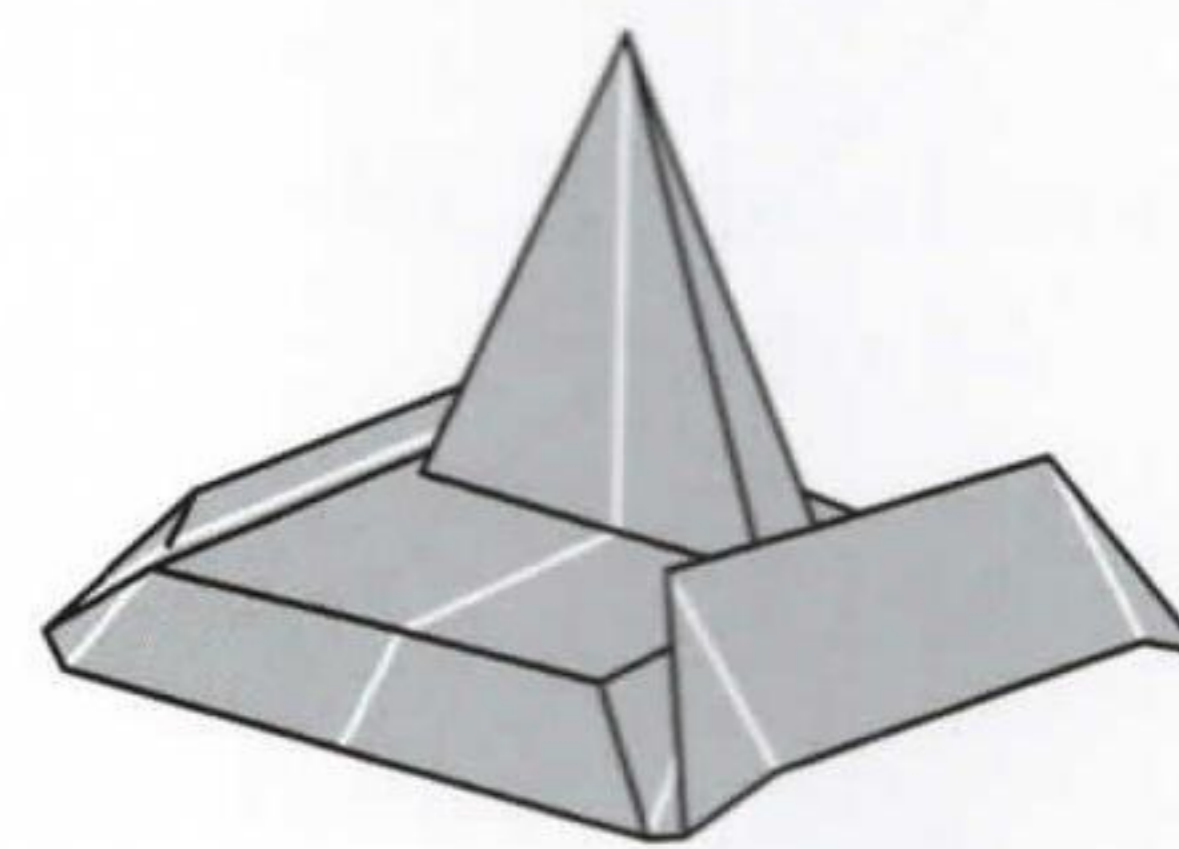
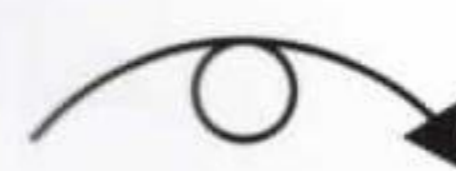

16. Completed
PART 2

ASSEMBLY

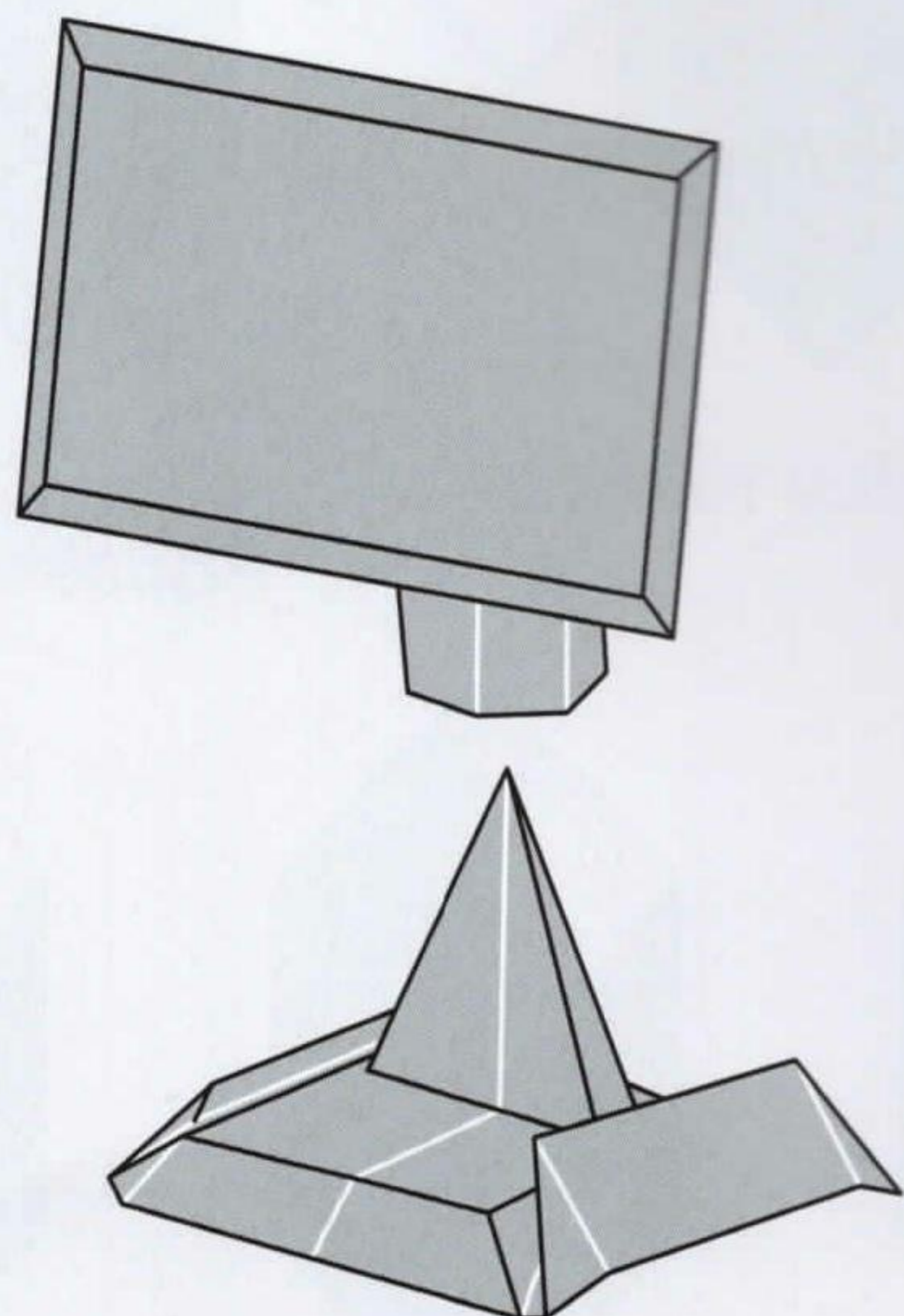

1. Insert Part 2 into Part 1
as indicated

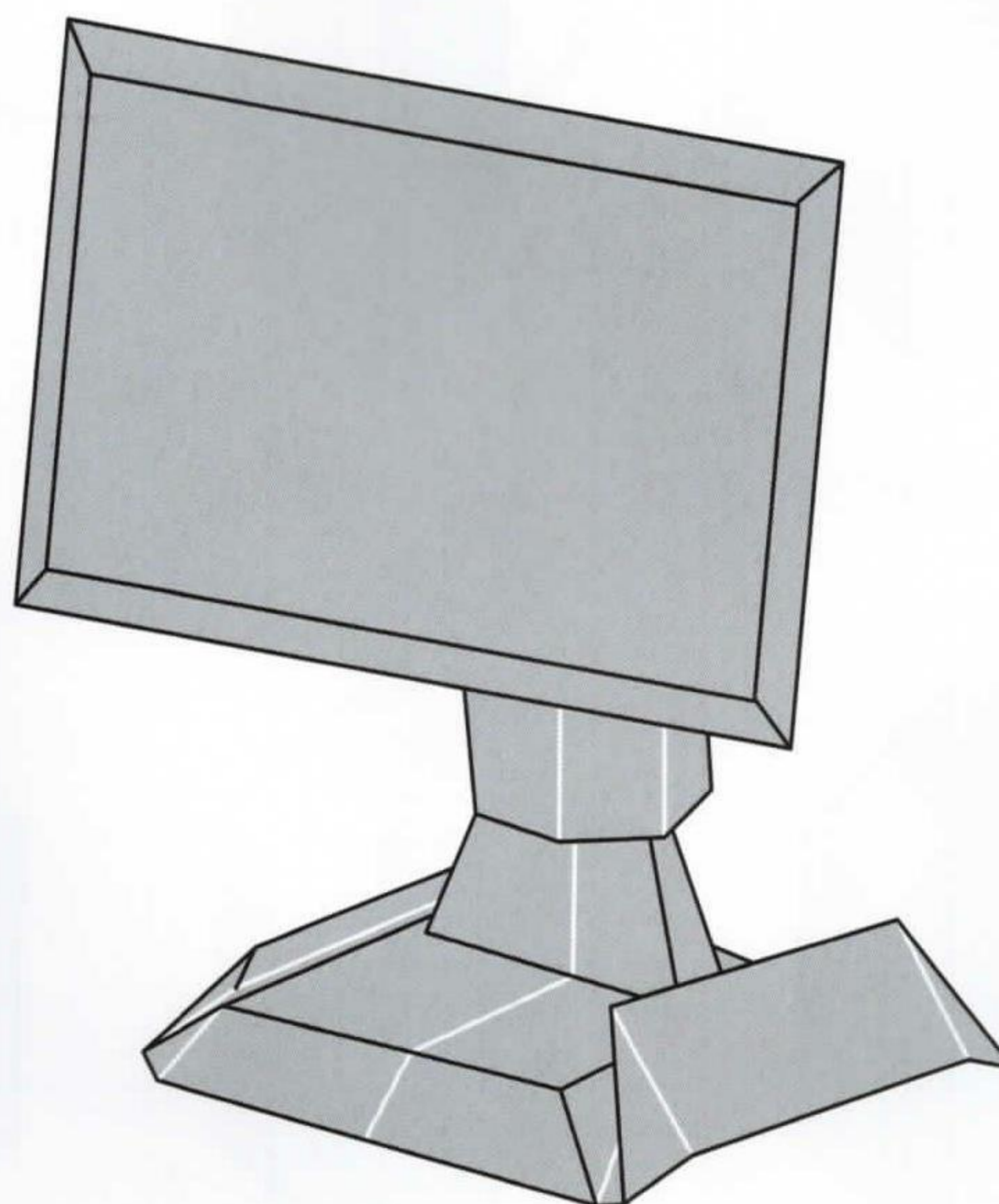

2. Completed
TELEVISION

► table lamp: part 1

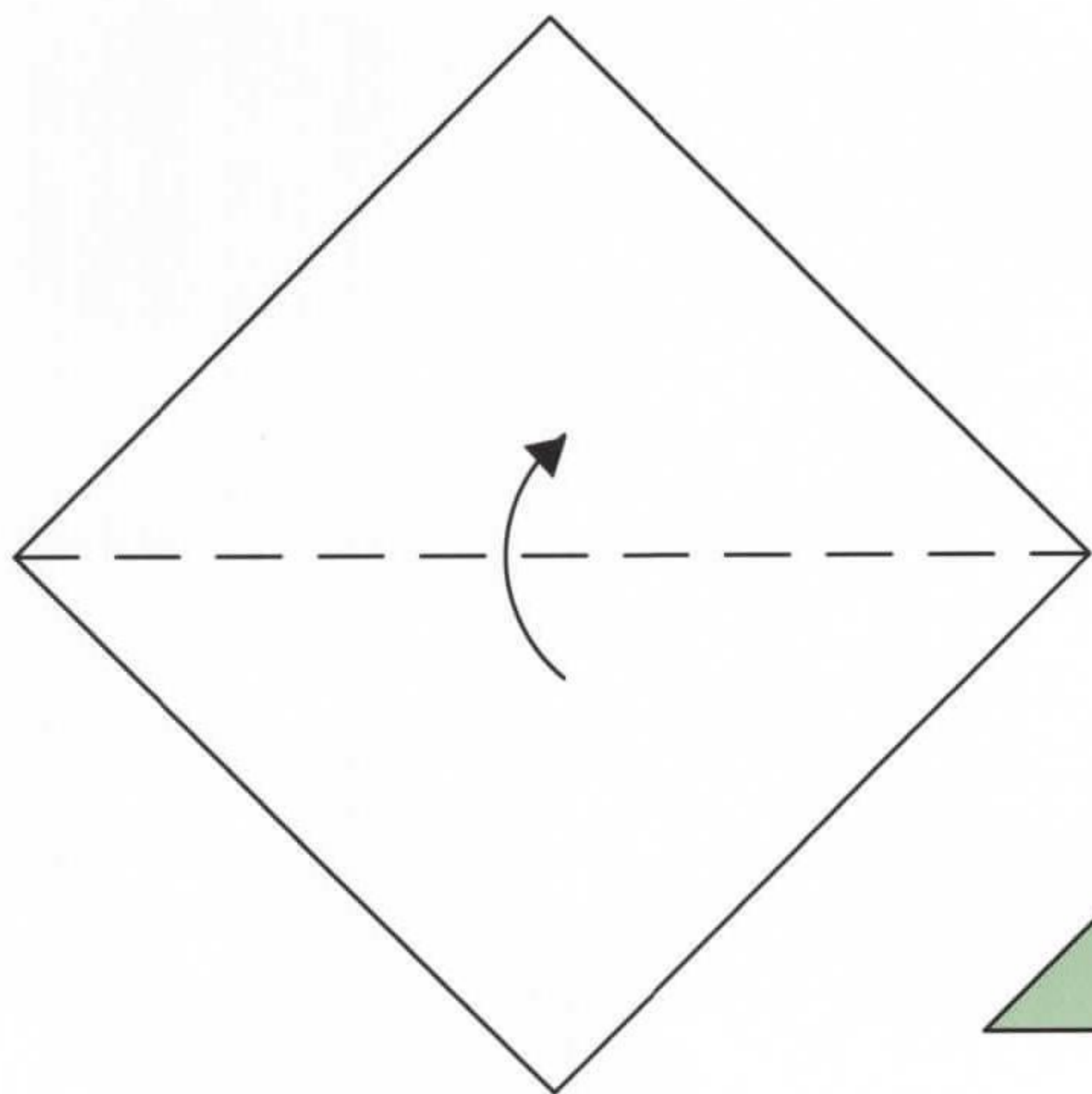

1. Valley fold

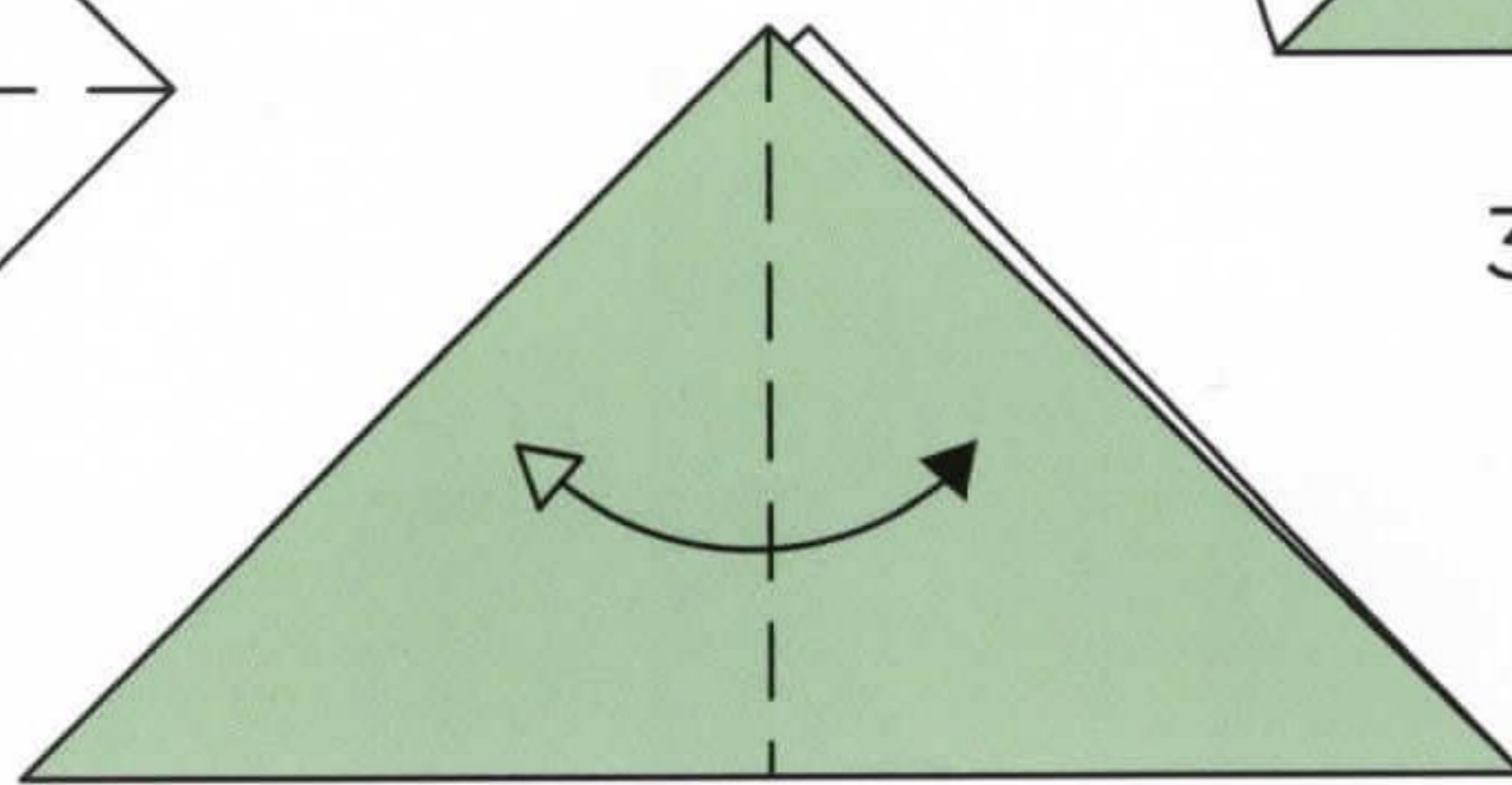

2. Valley fold and unfold

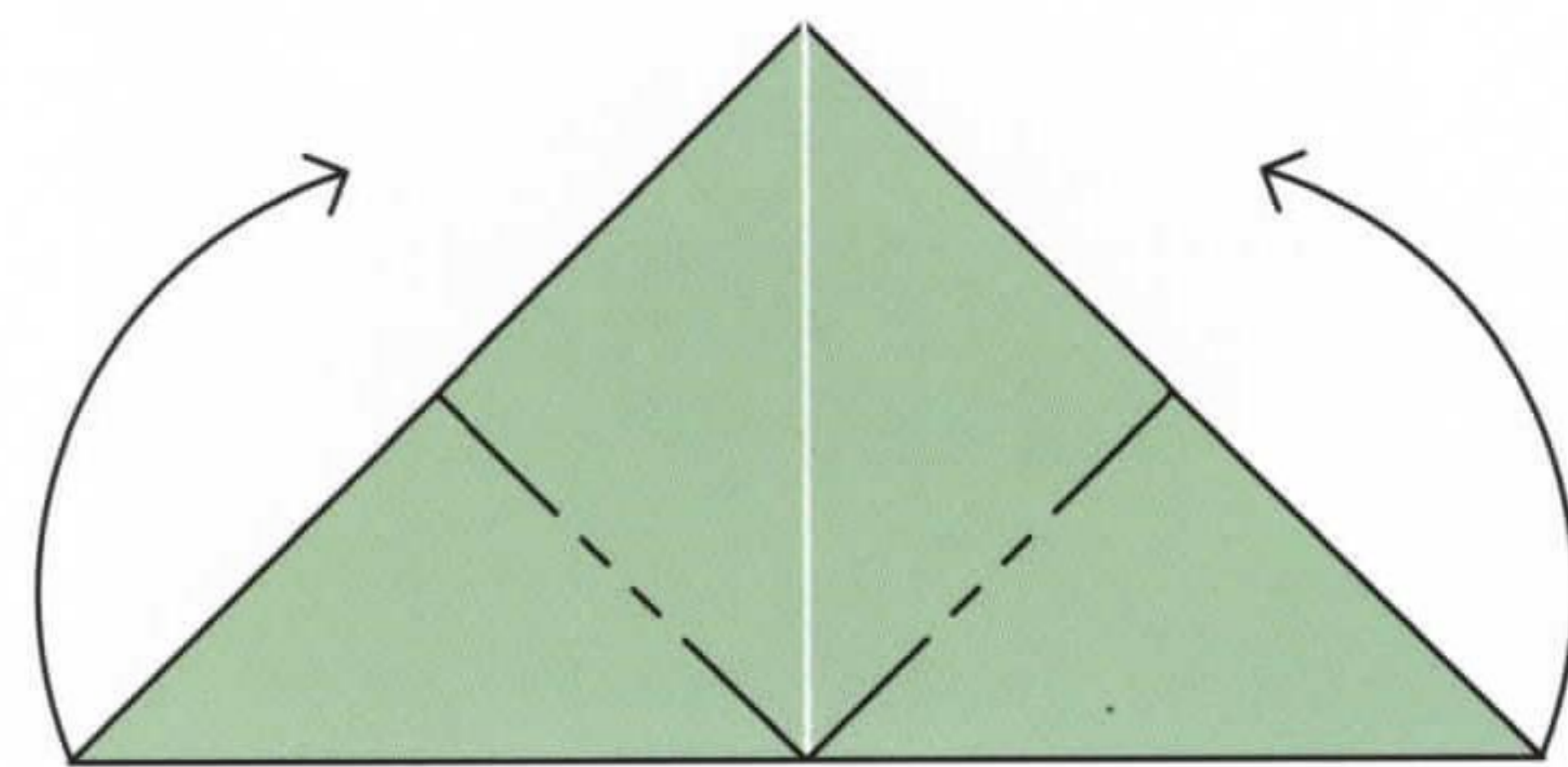

3. Inside reverse folds

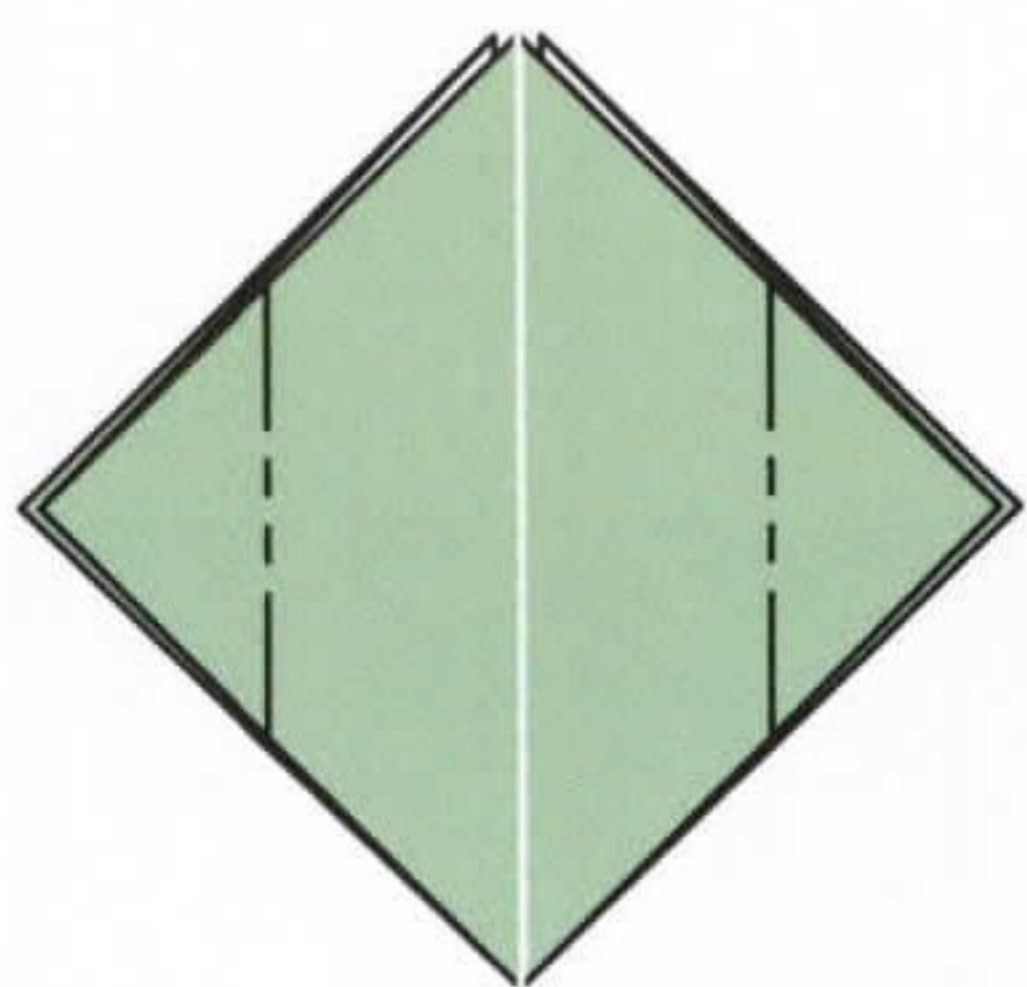

4. Inside reverse folds

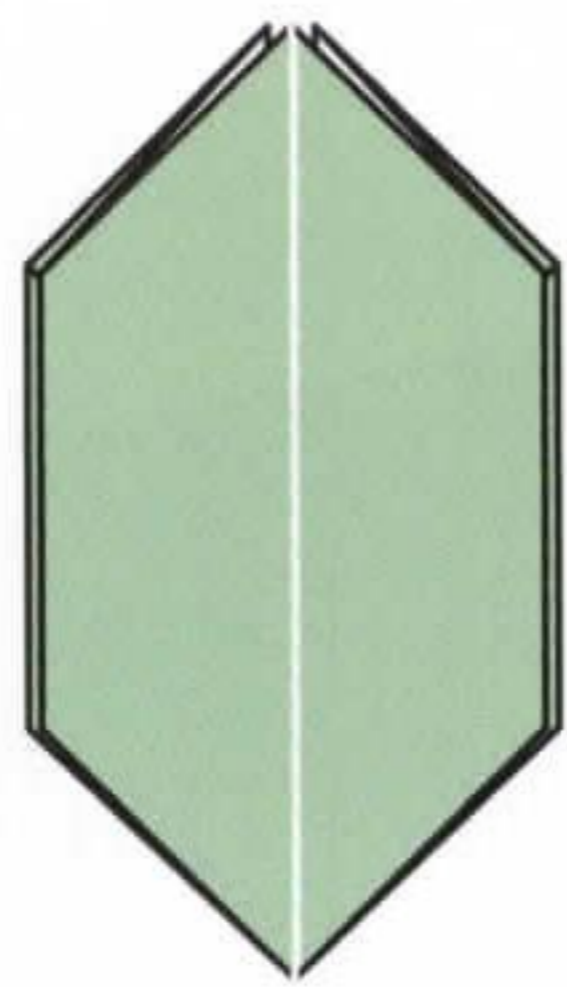

5. Scale-up

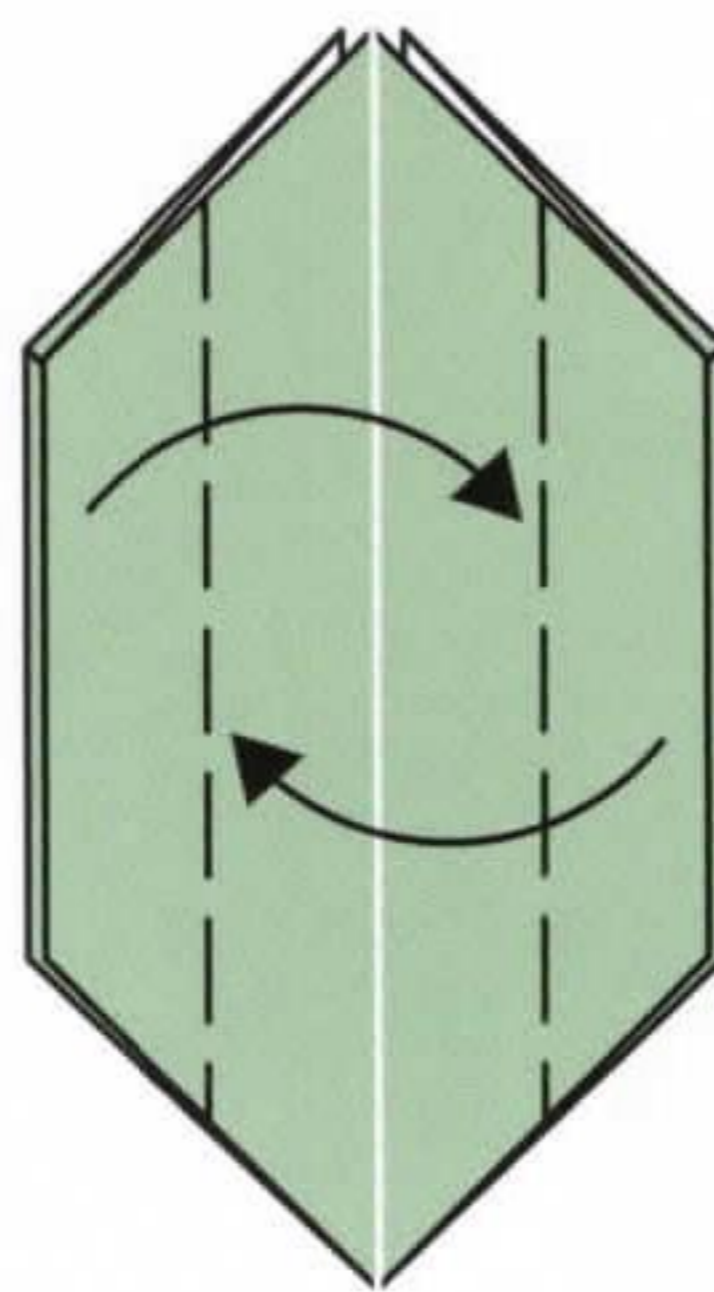

6. Valley folds

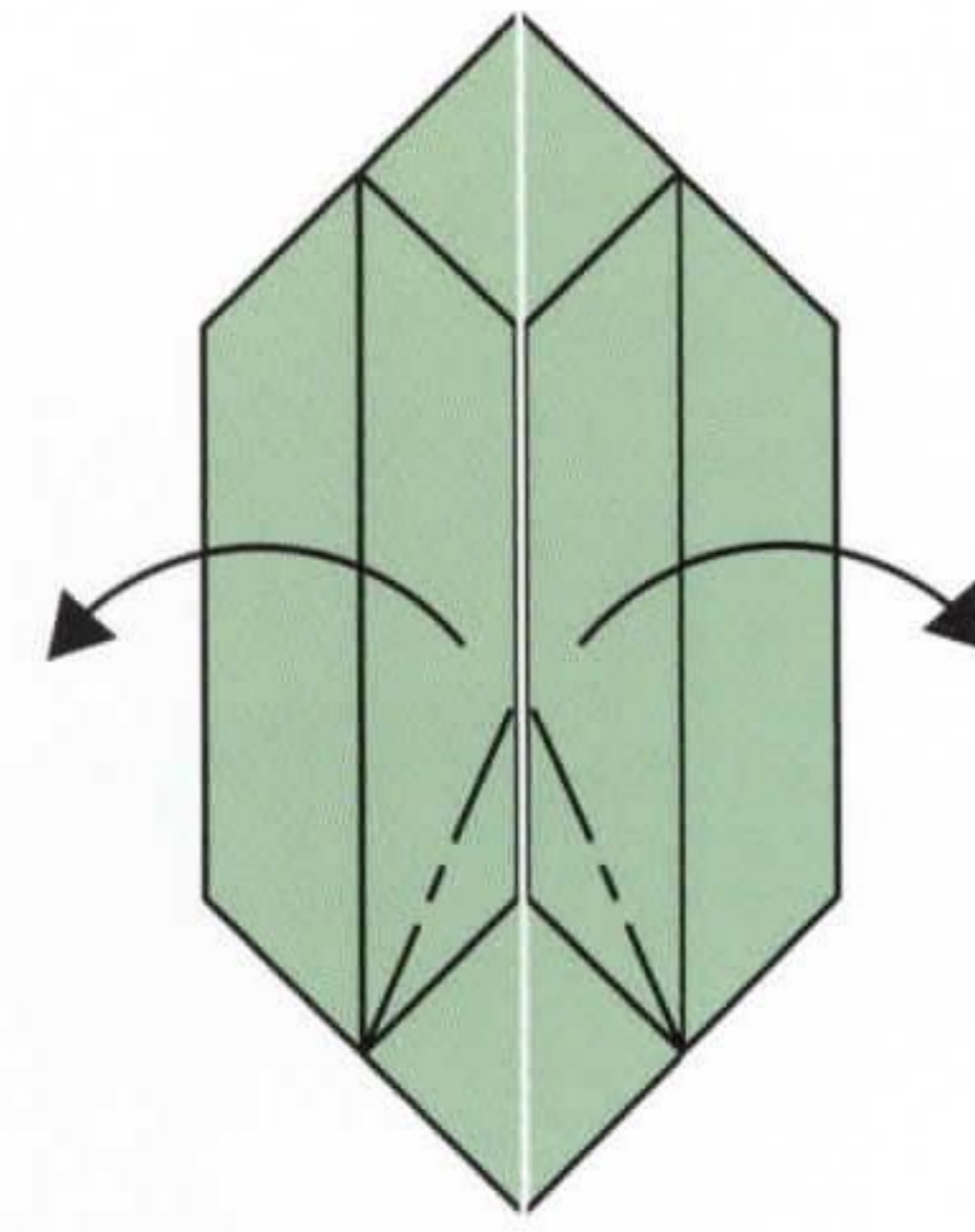

7. Valley folds and Squash folds

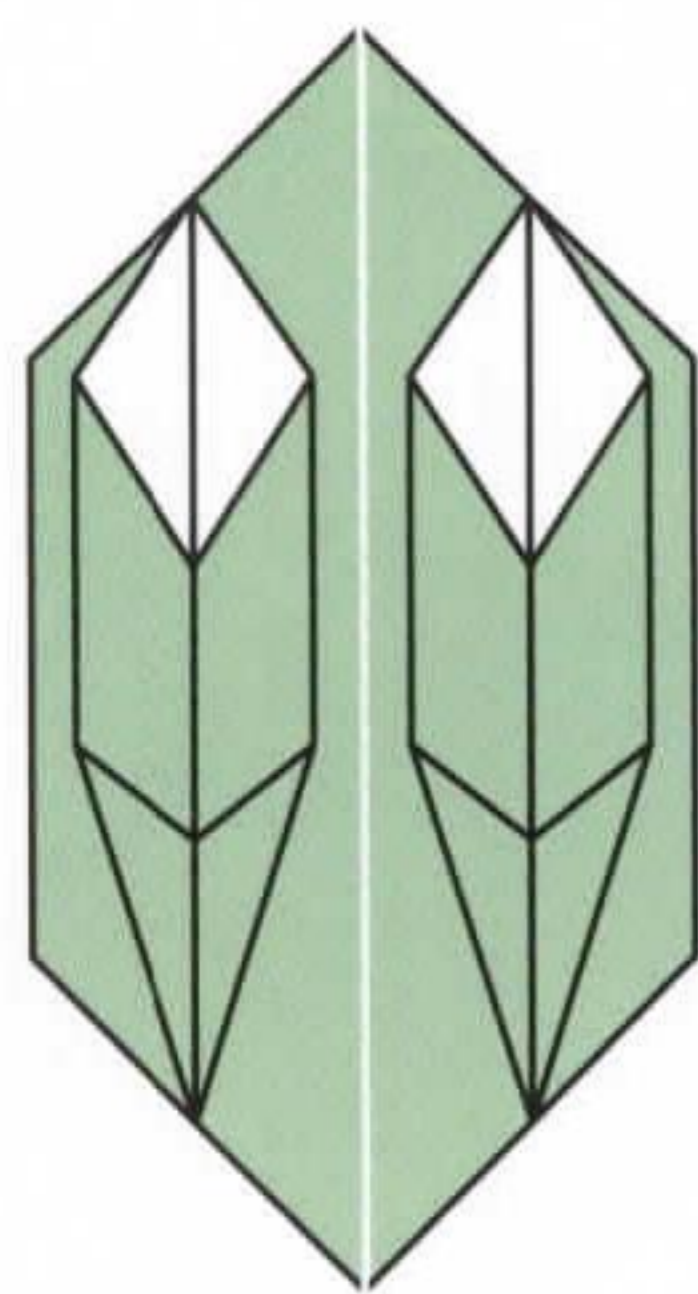

8. Before complete

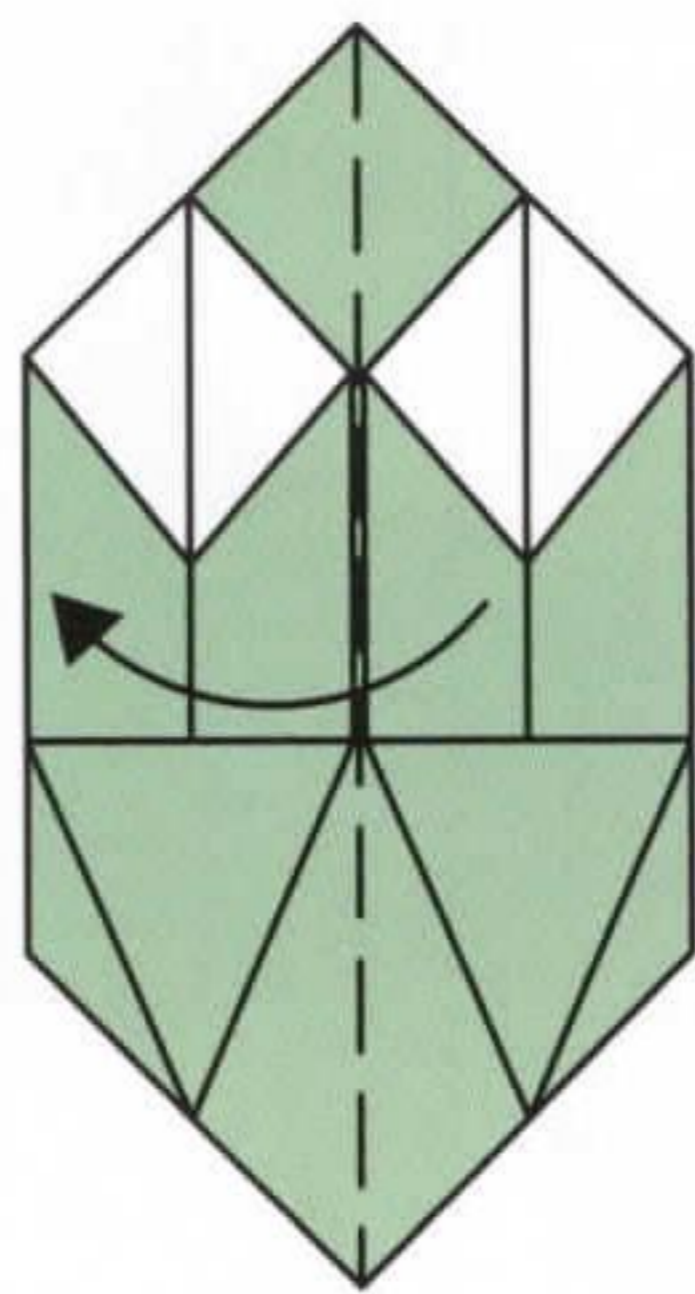

9. Valley fold

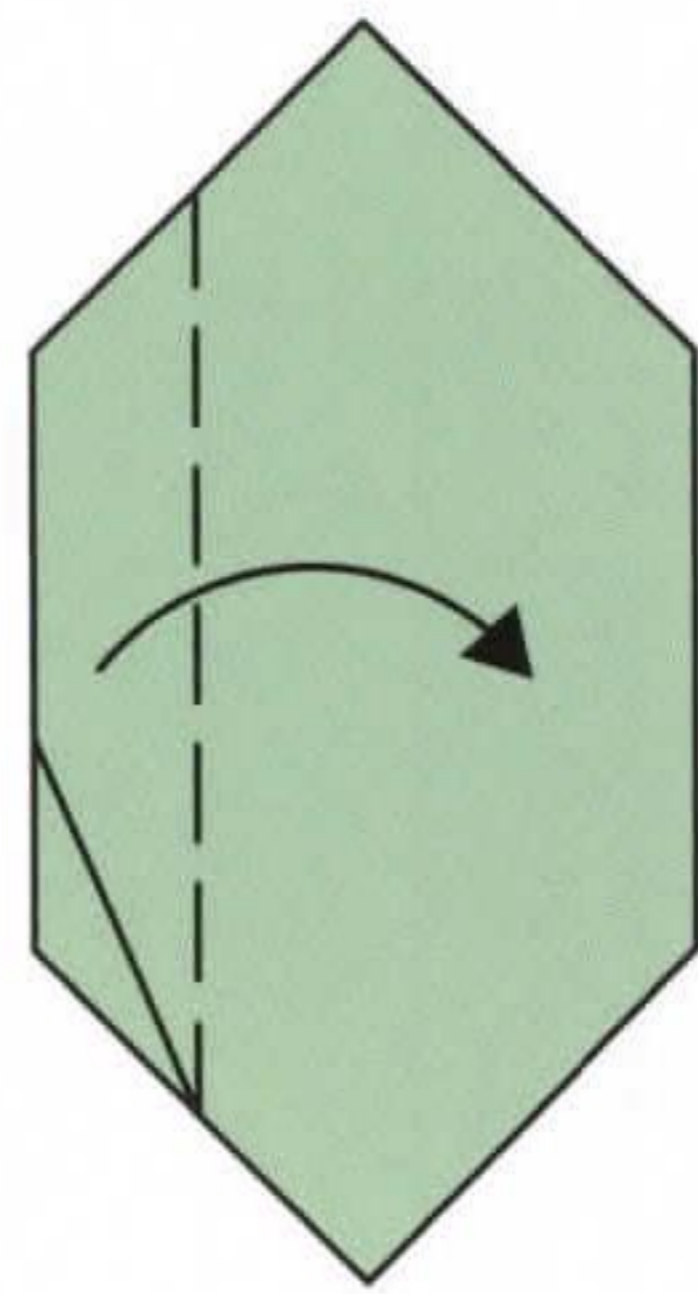

10. Valley fold

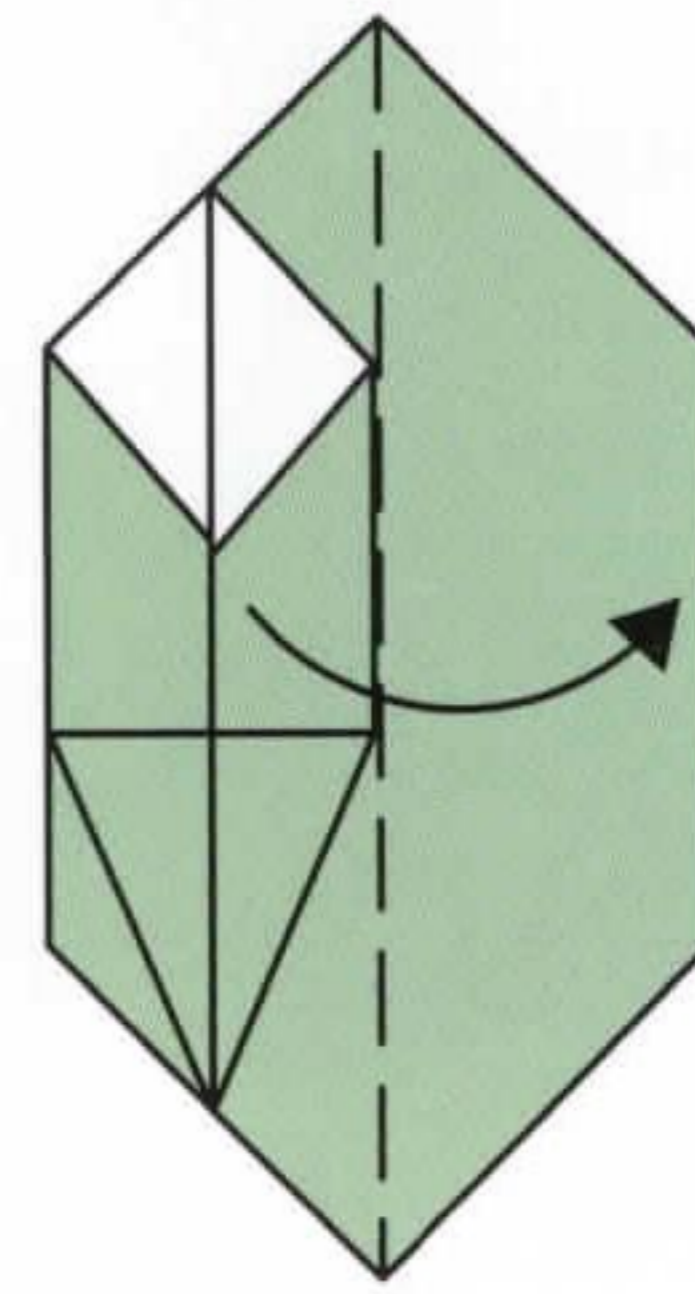

11. Valley fold

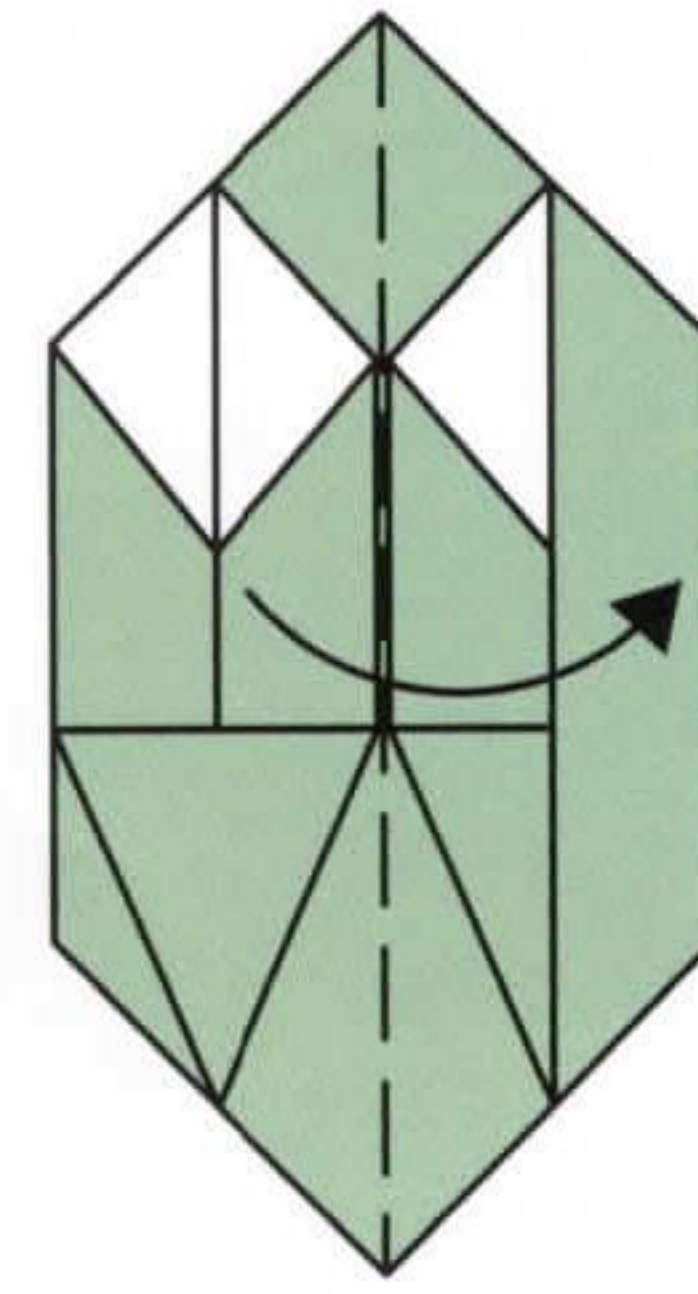

12. Valley fold

table lamp: part 1

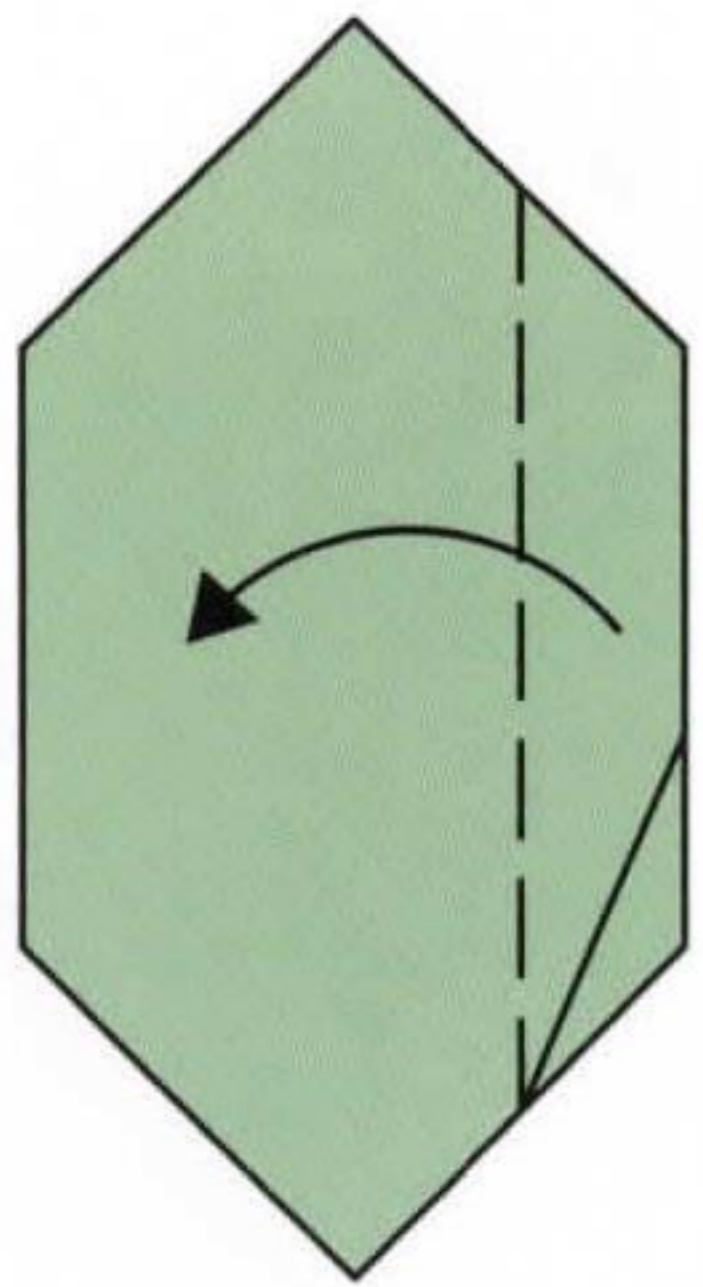

13. Valley fold

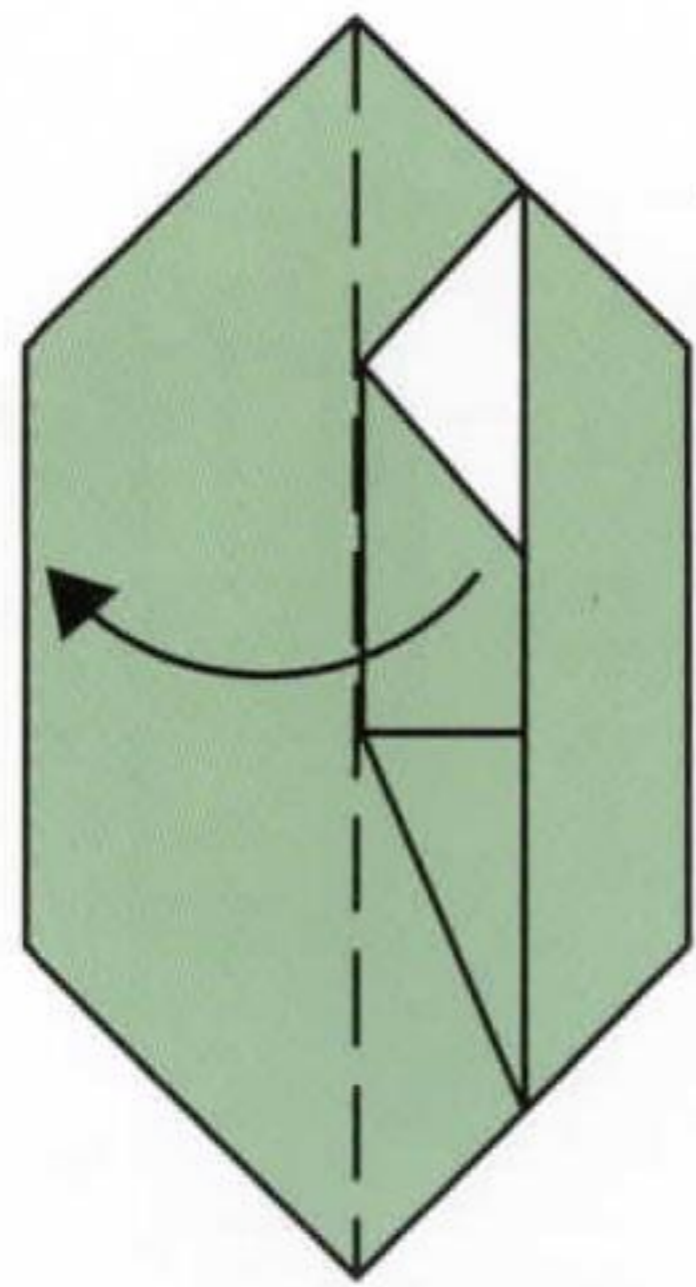

14. Valley fold

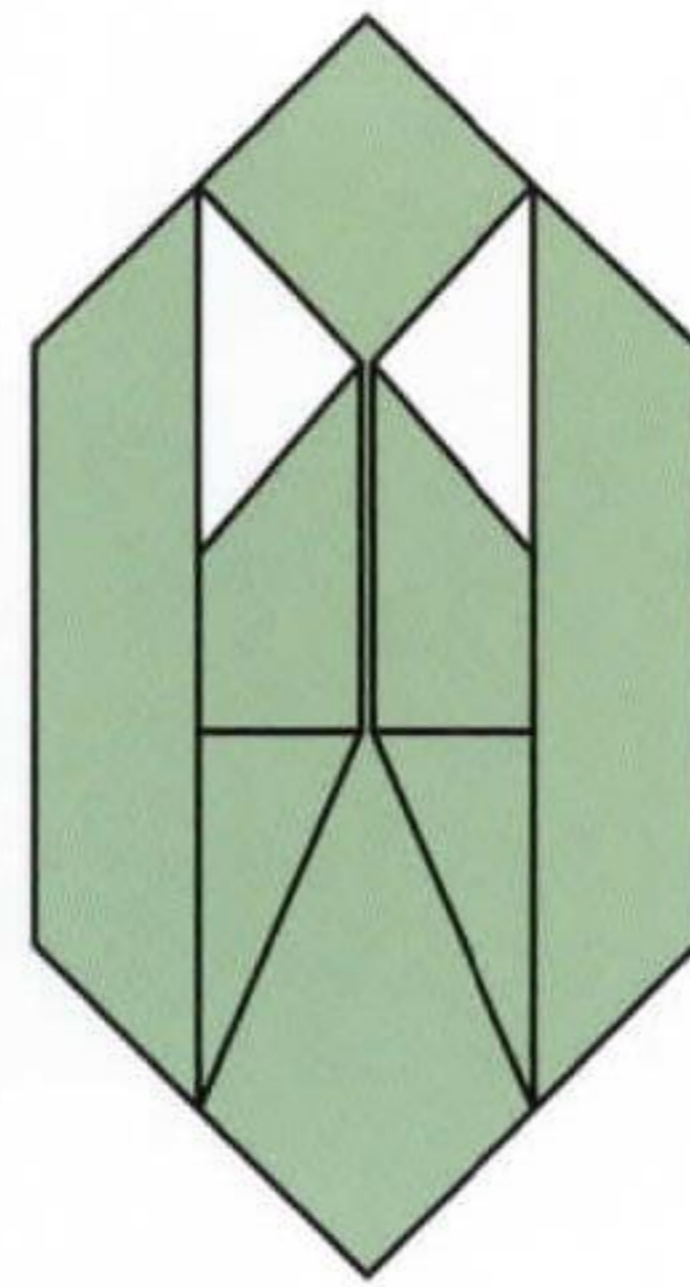

15. Turn over

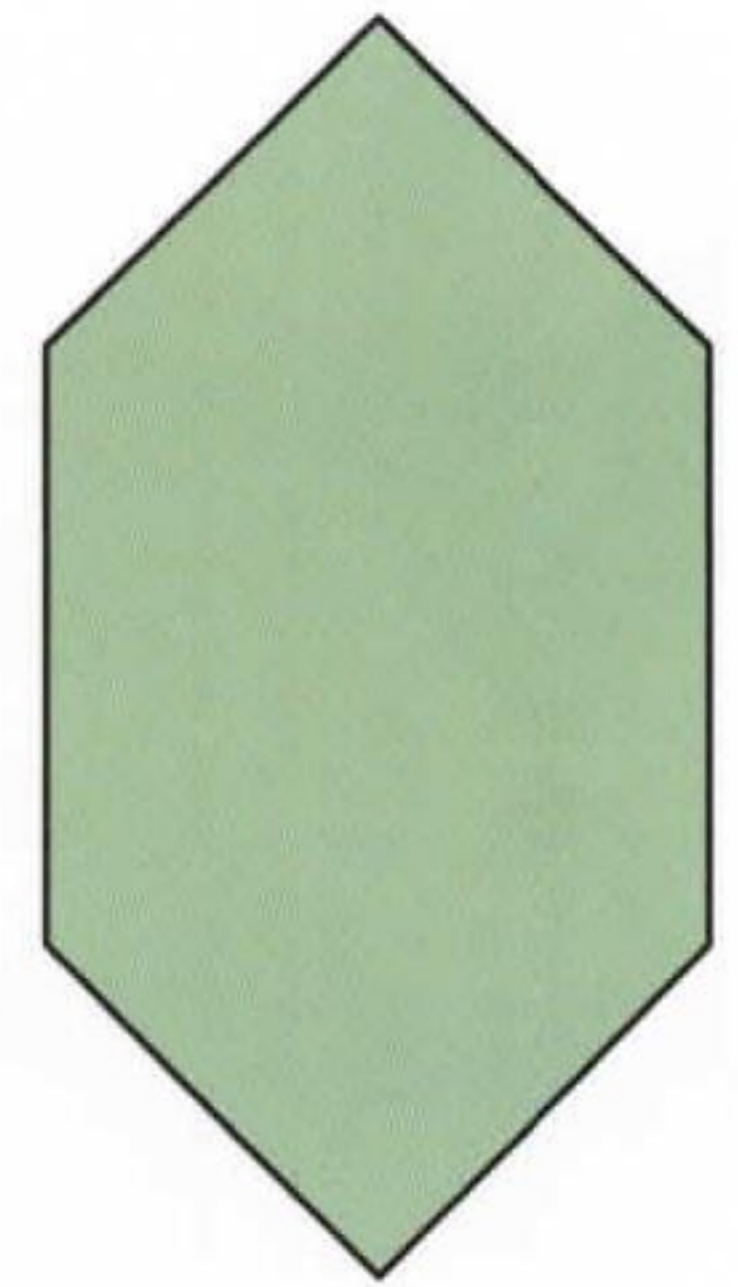

16. Repeat steps 6 to 14

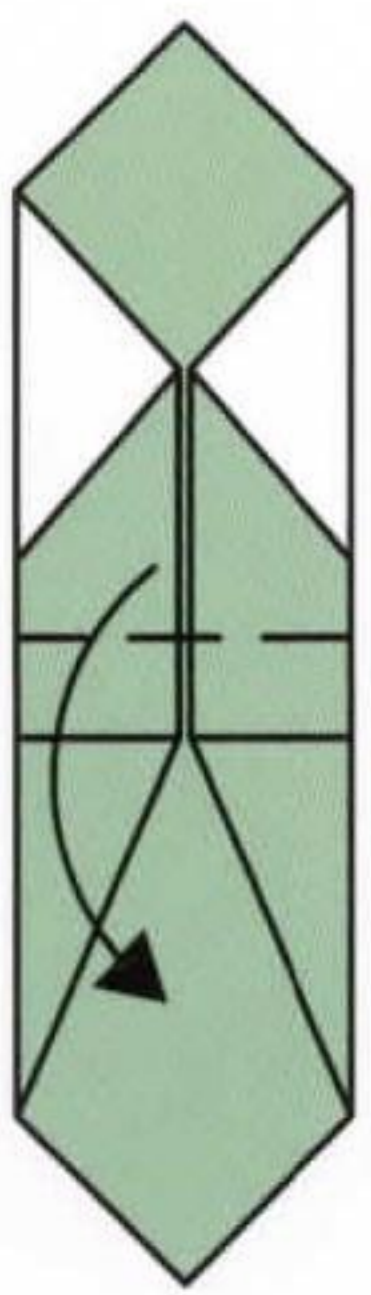

17. Valley fold

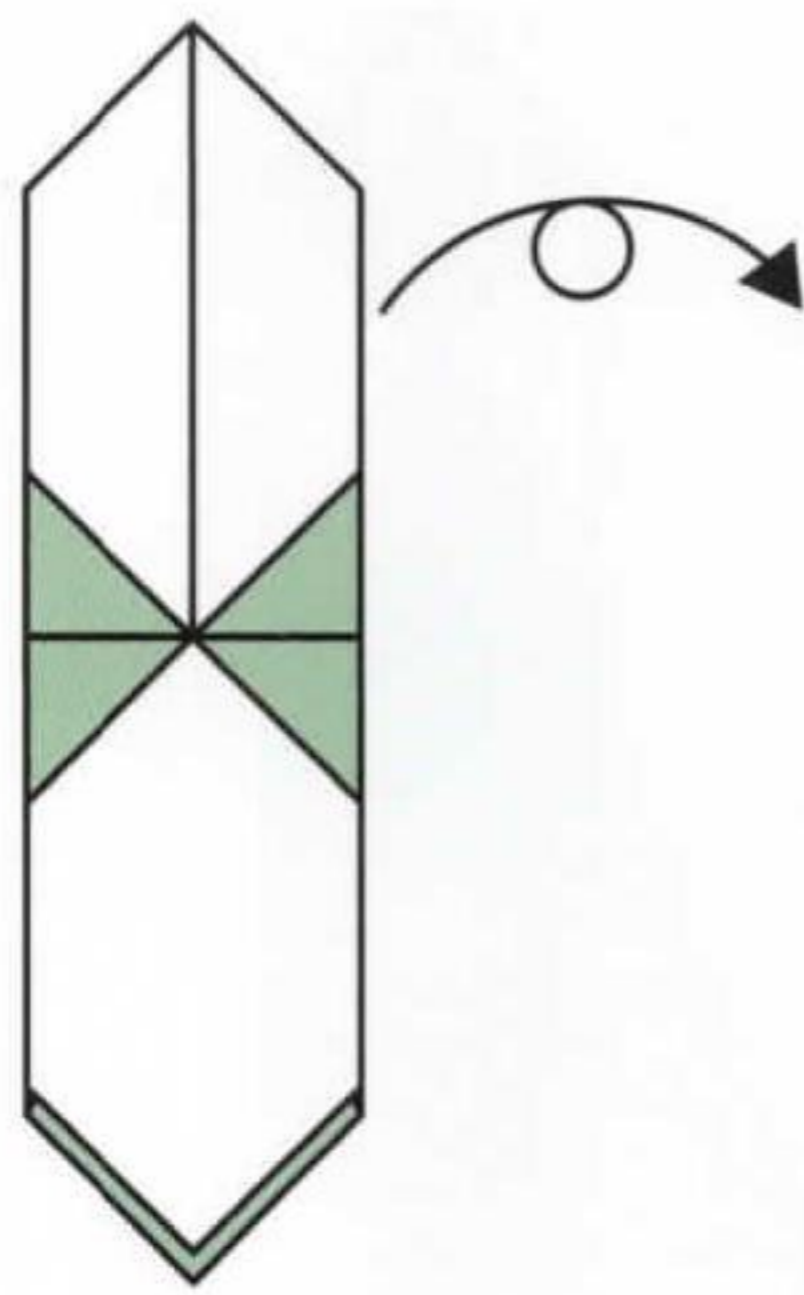

18. Turn over

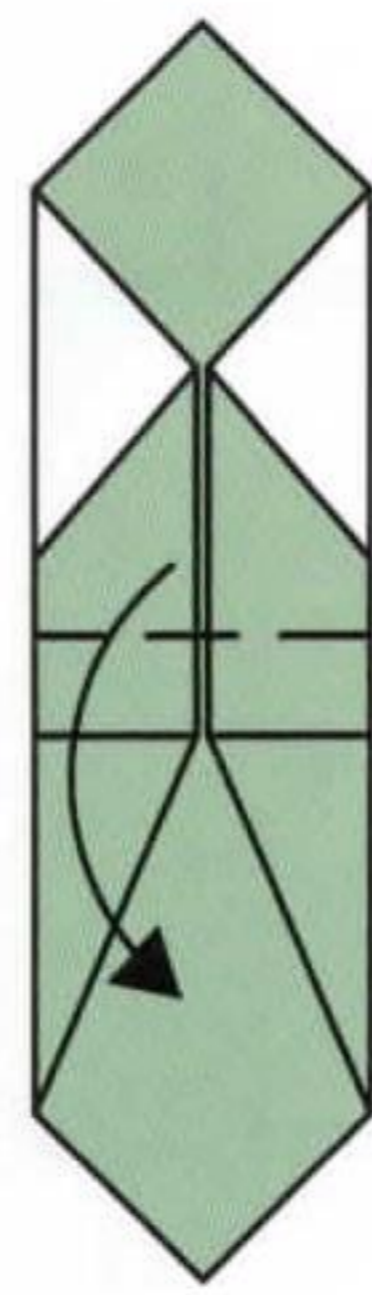

19. Valley fold

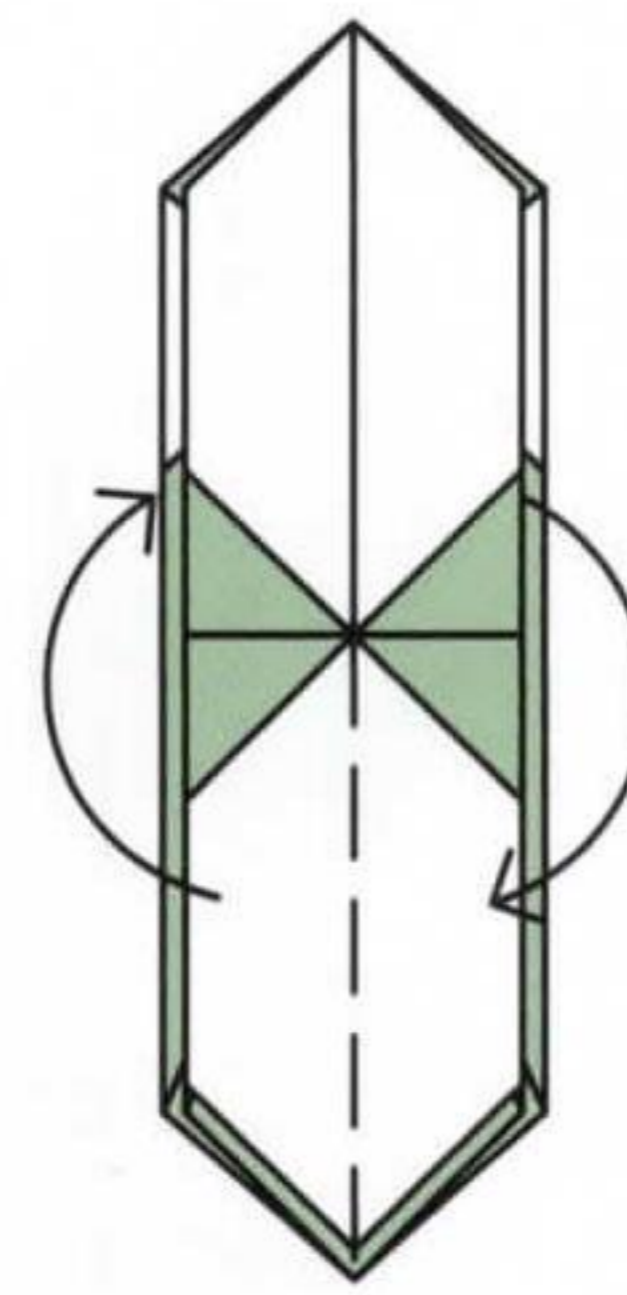

20. Open flaps

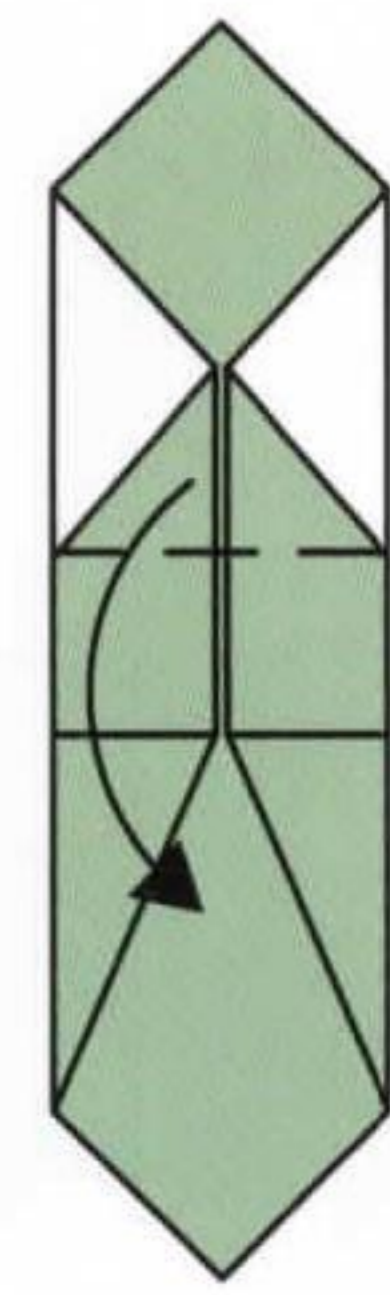

21. Valley fold

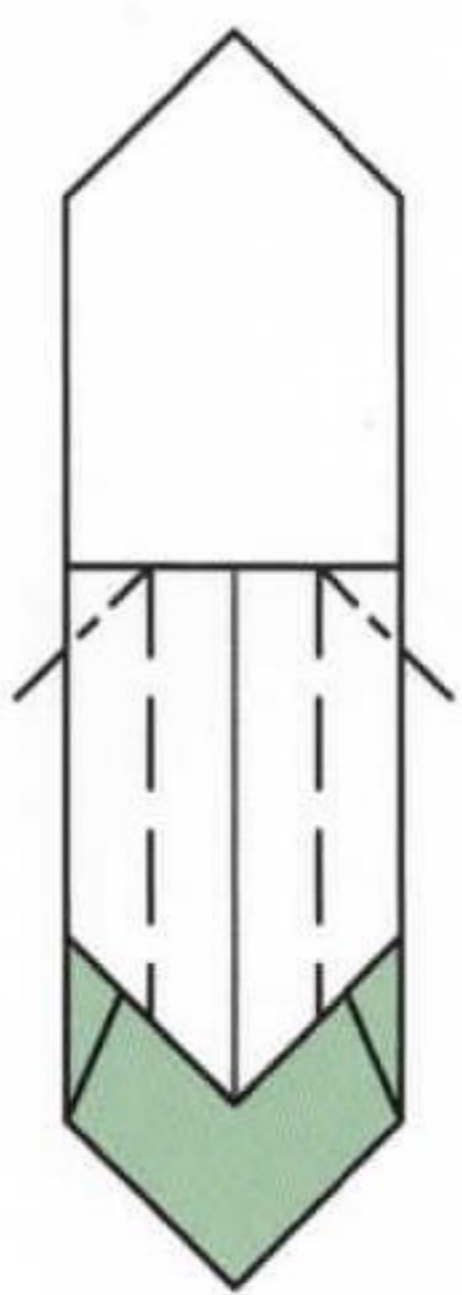

22. Squash folds

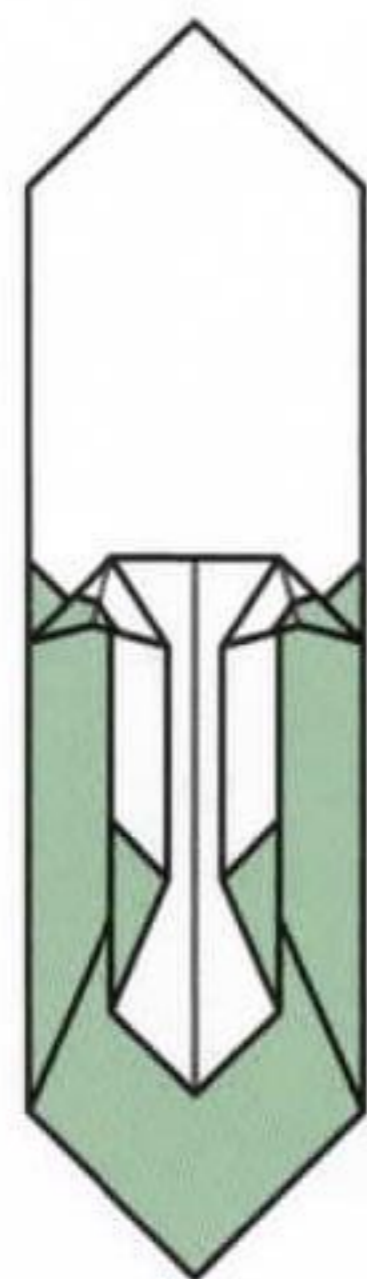

23. Before complete

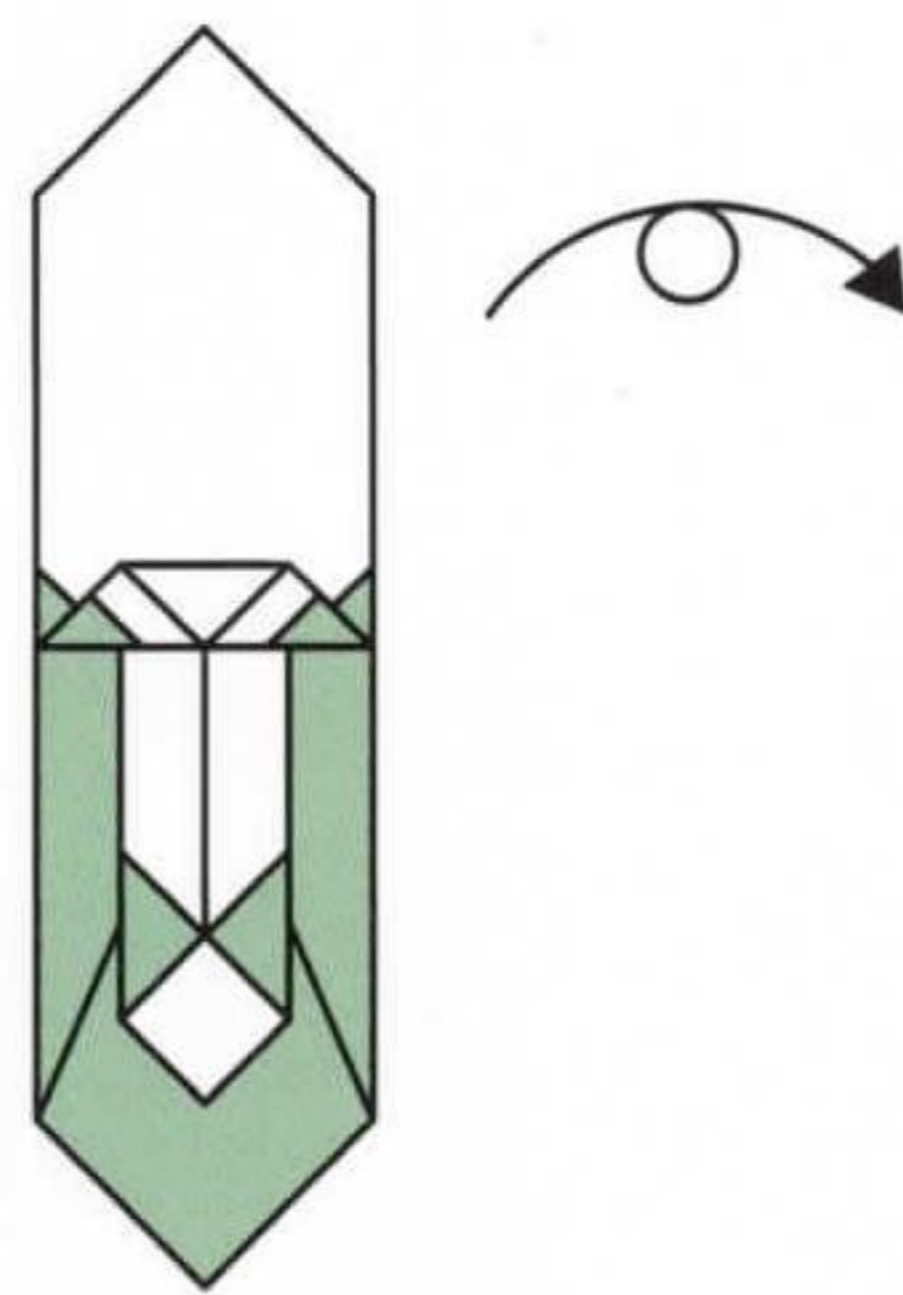

24. Turn over

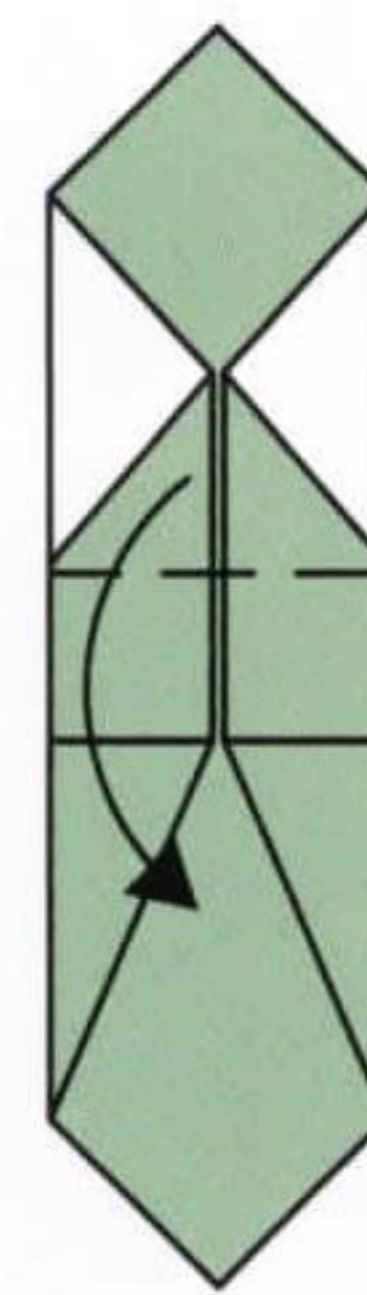

25. Valley fold

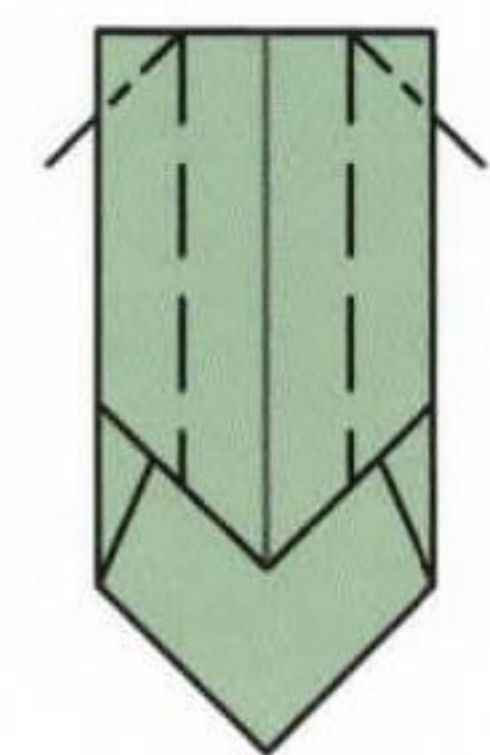

26. Squash folds

table lamp: part 1

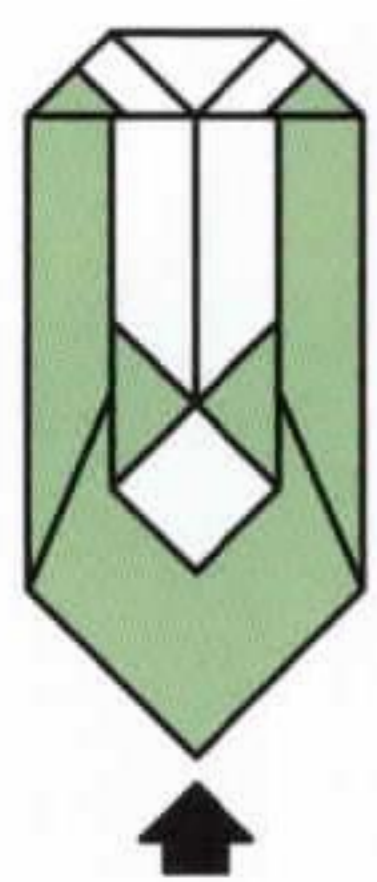

27. Sink fold

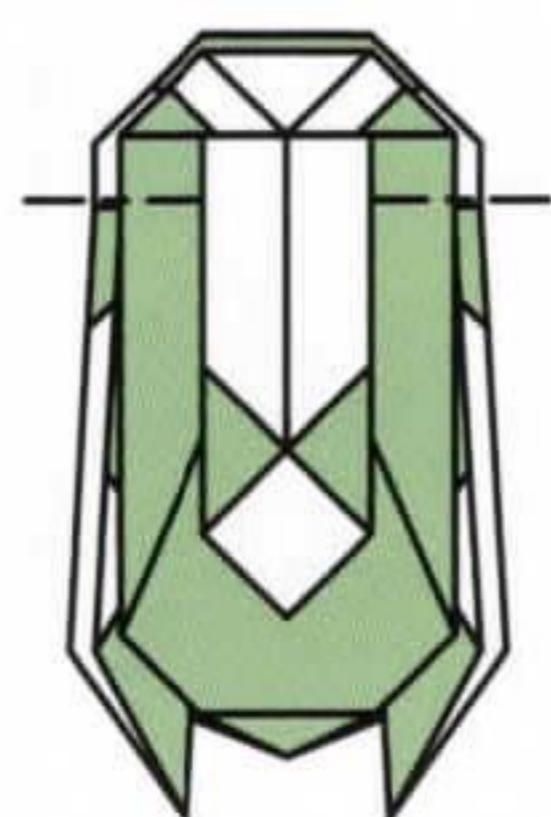

28. Mountain fold

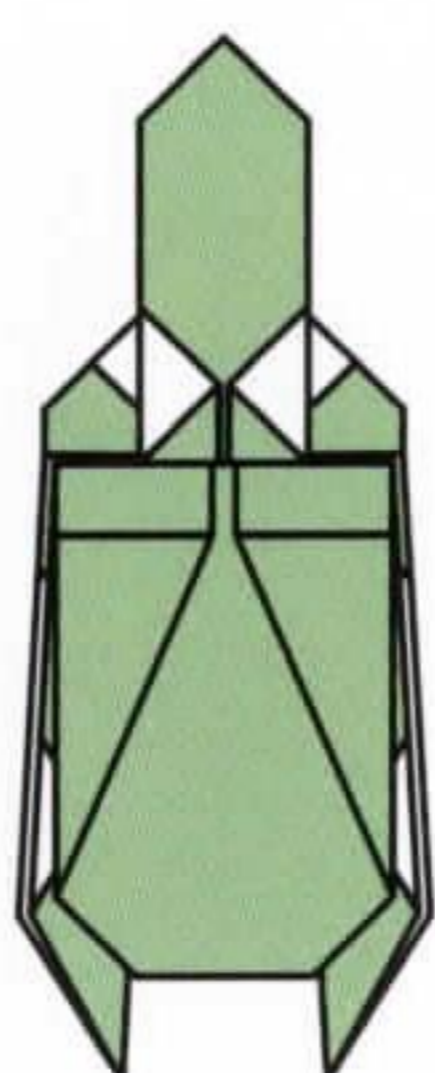

29. Turn over

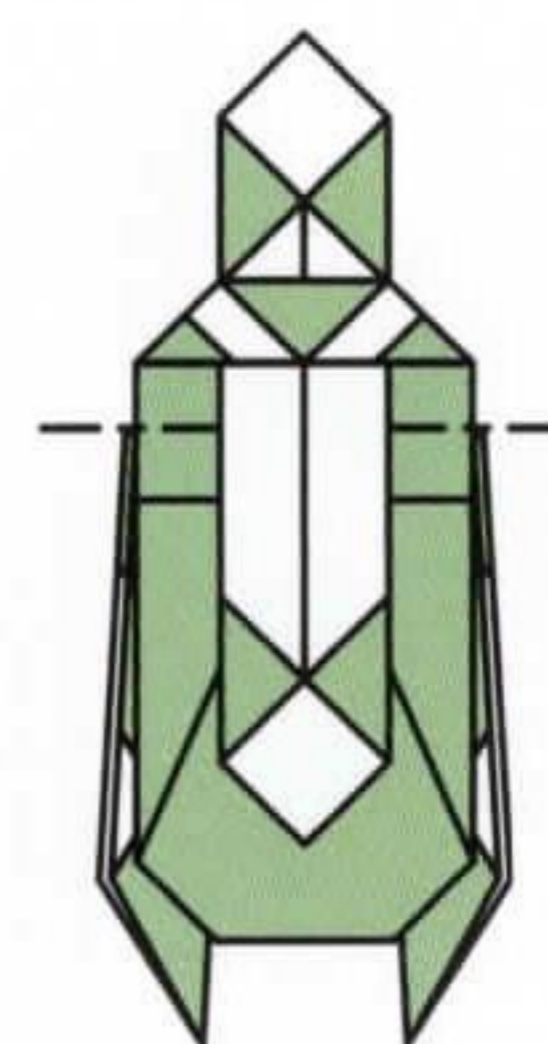

30. Mountain fold

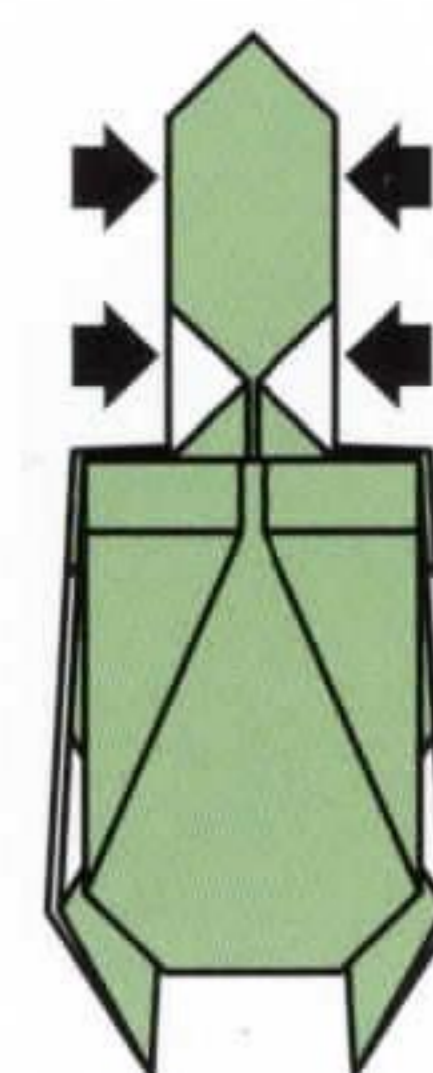

31. Add glue to sides

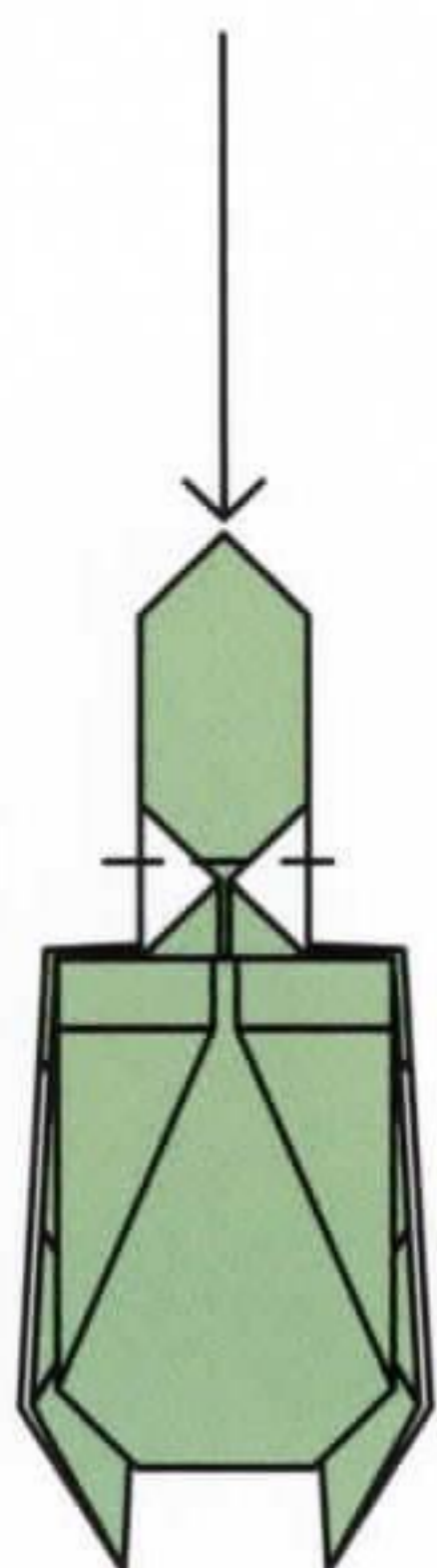

32. Push and Valley folds

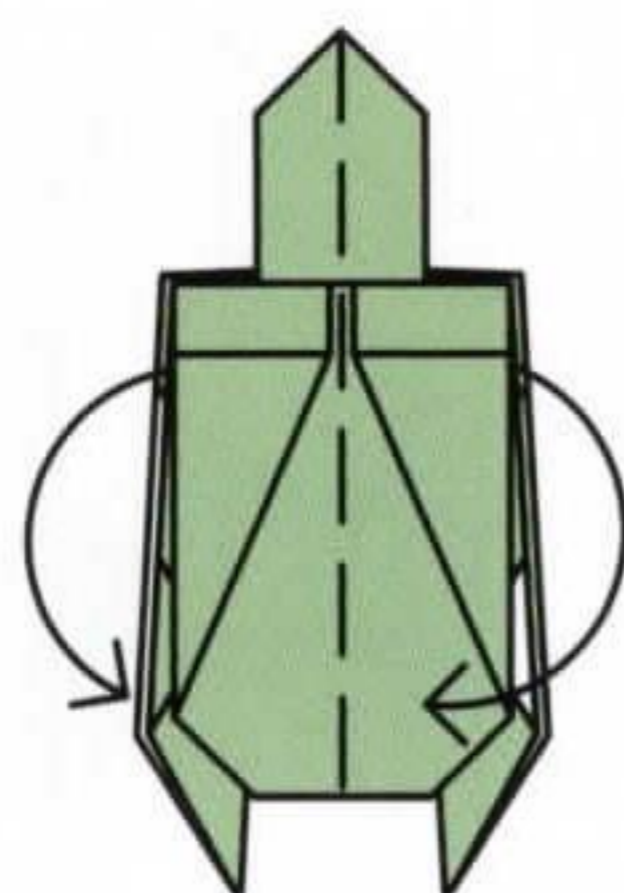

33. Open flaps

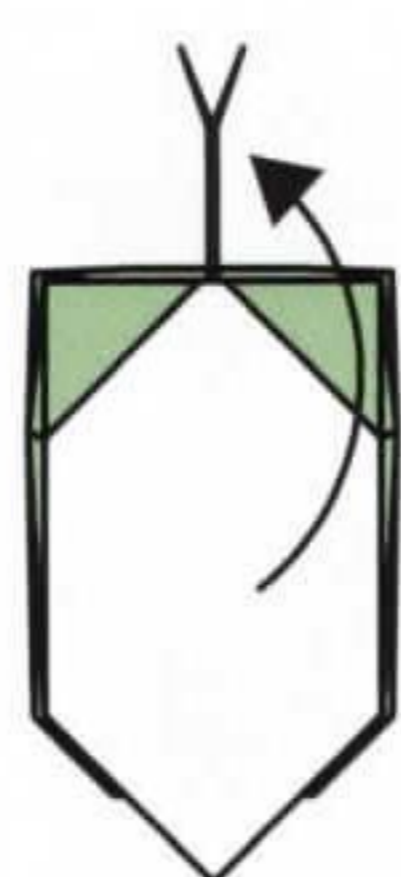

34. Valley fold

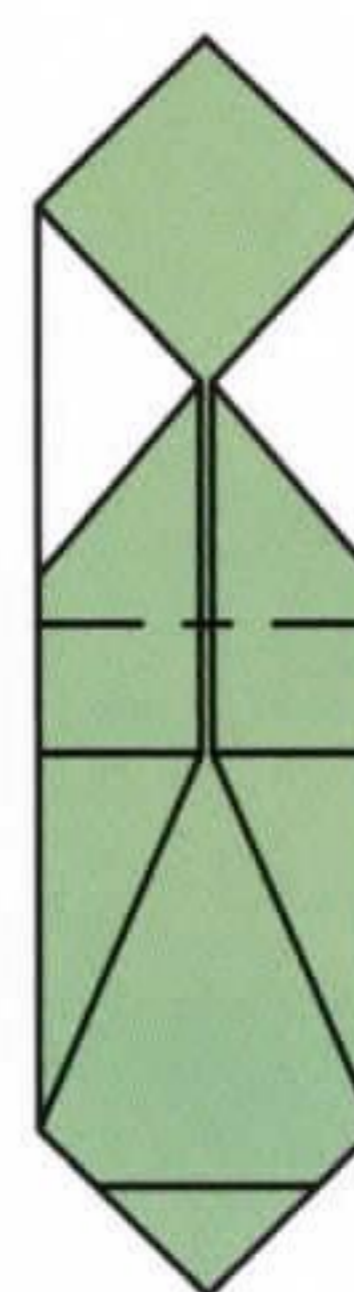

35. Mountain fold to tuck into center

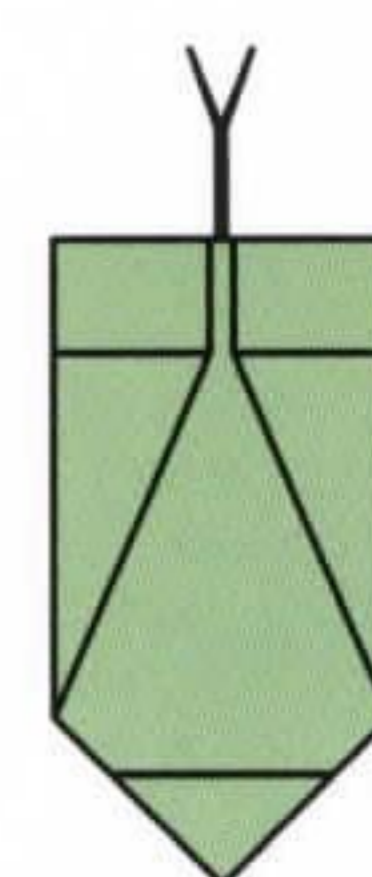

36. Turn over



37. Valley fold

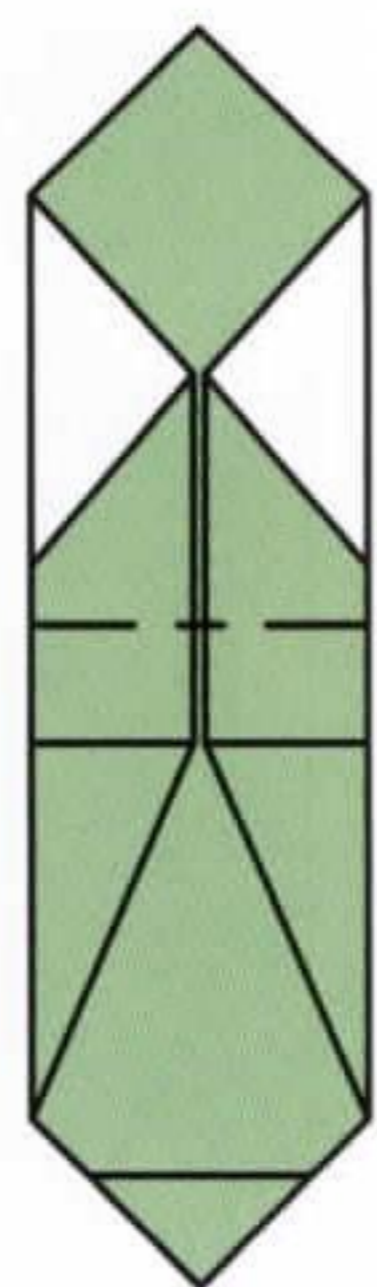

38. Mountain fold to tuck into center

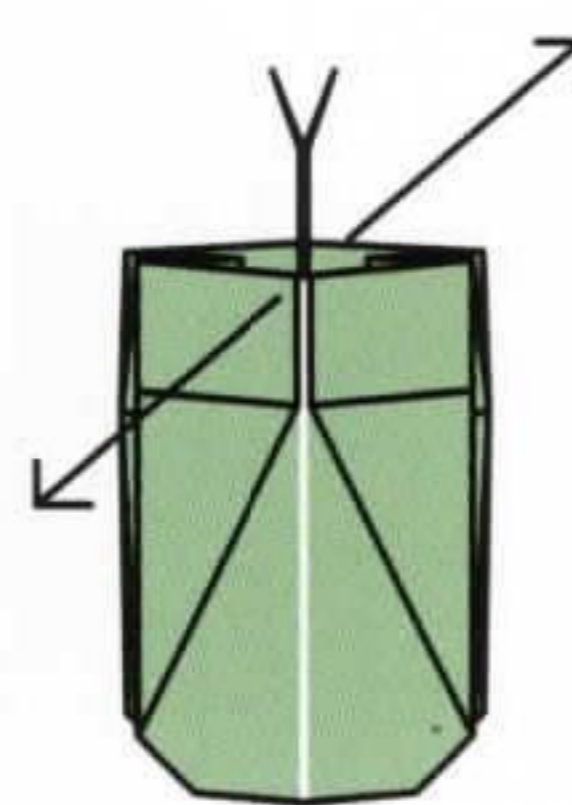

39. Pull to open all sides

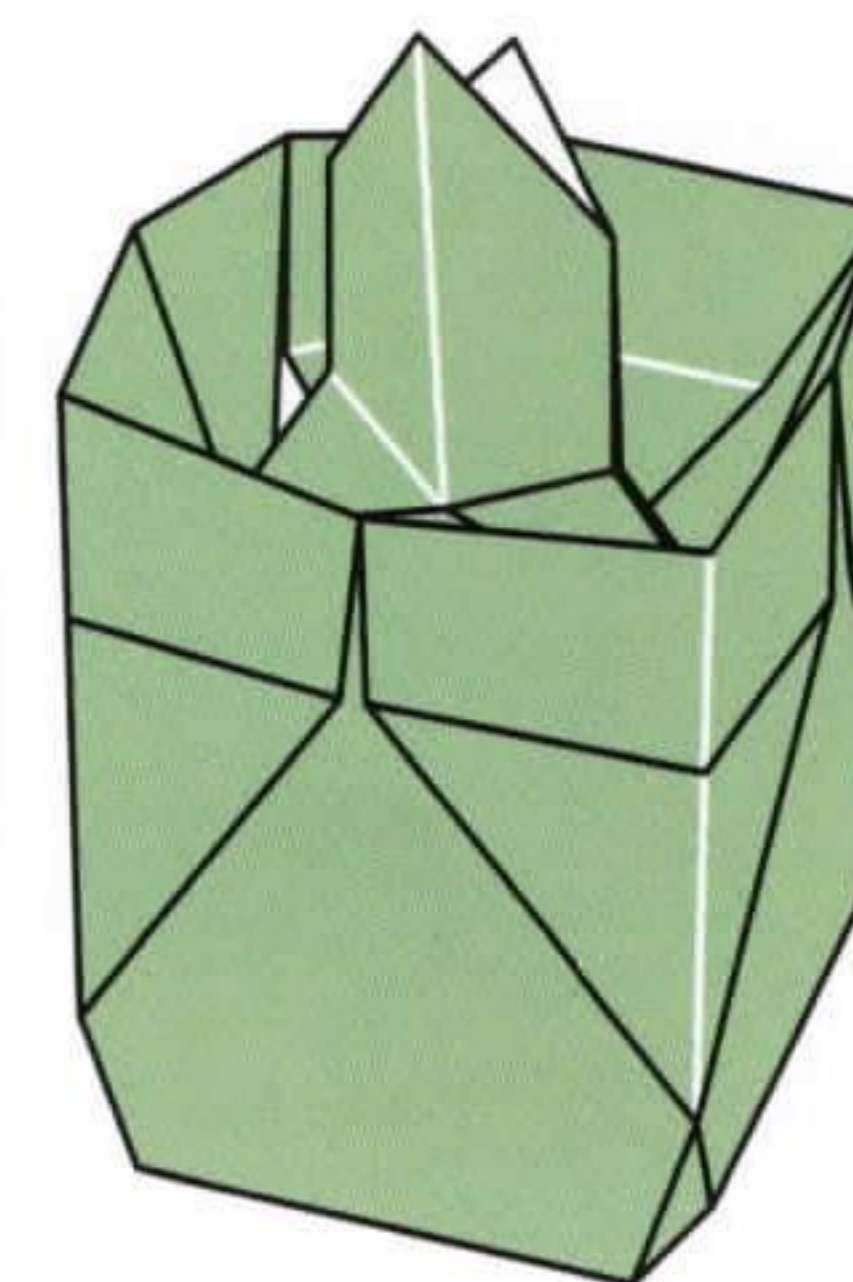

40. Completed PART 1

table lamp: part 2

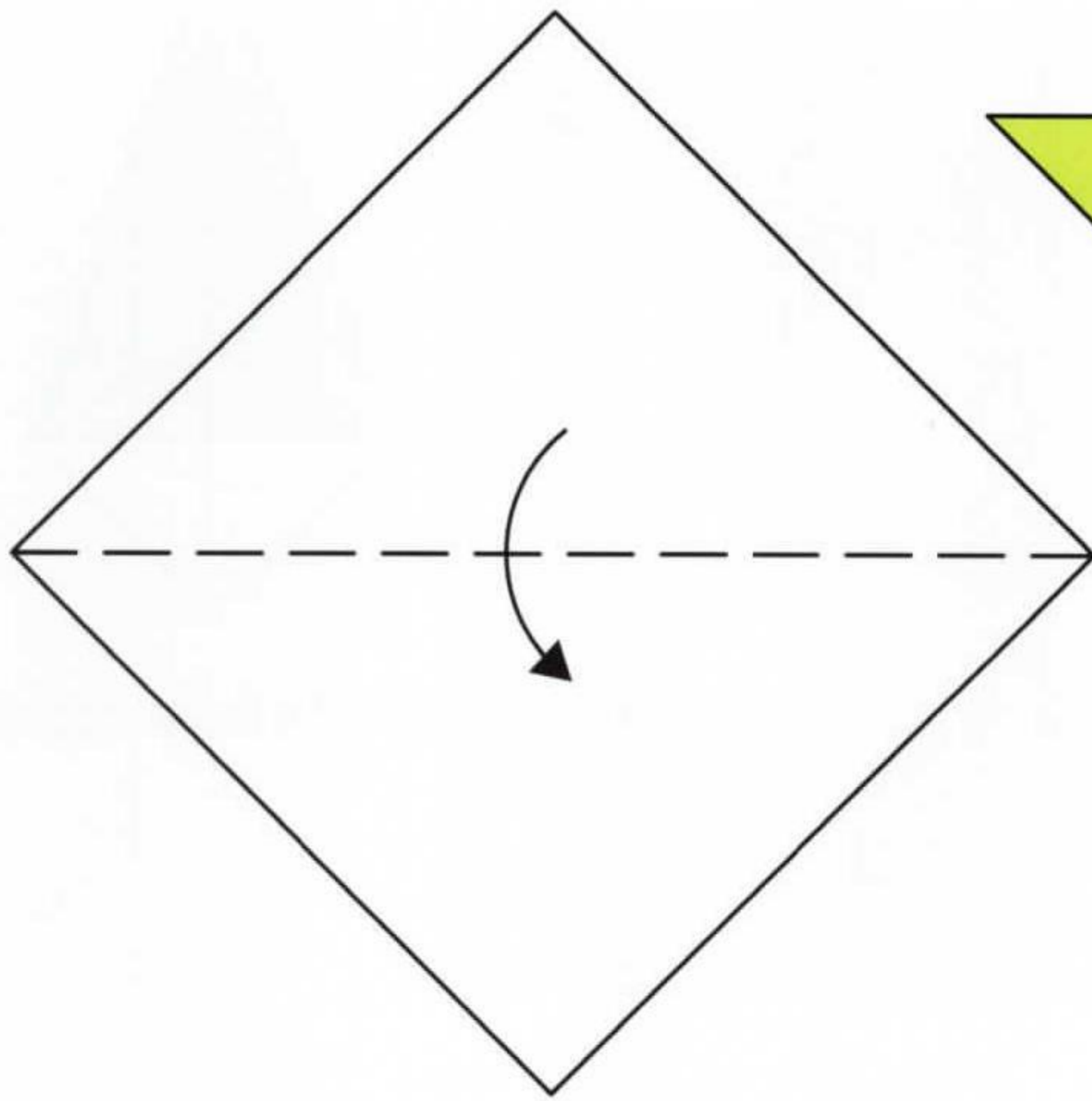

1. Valley fold

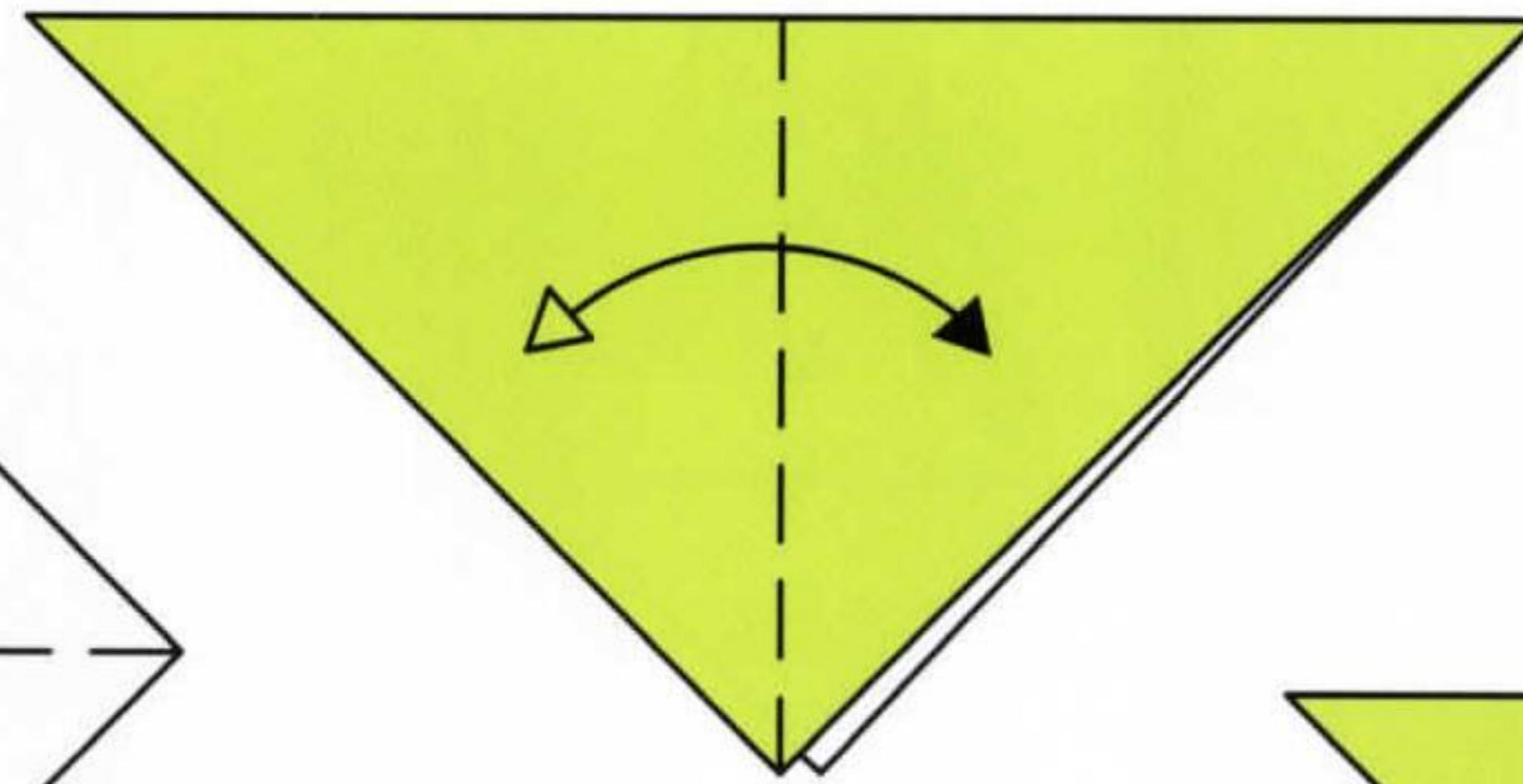

2. Fold and unfold

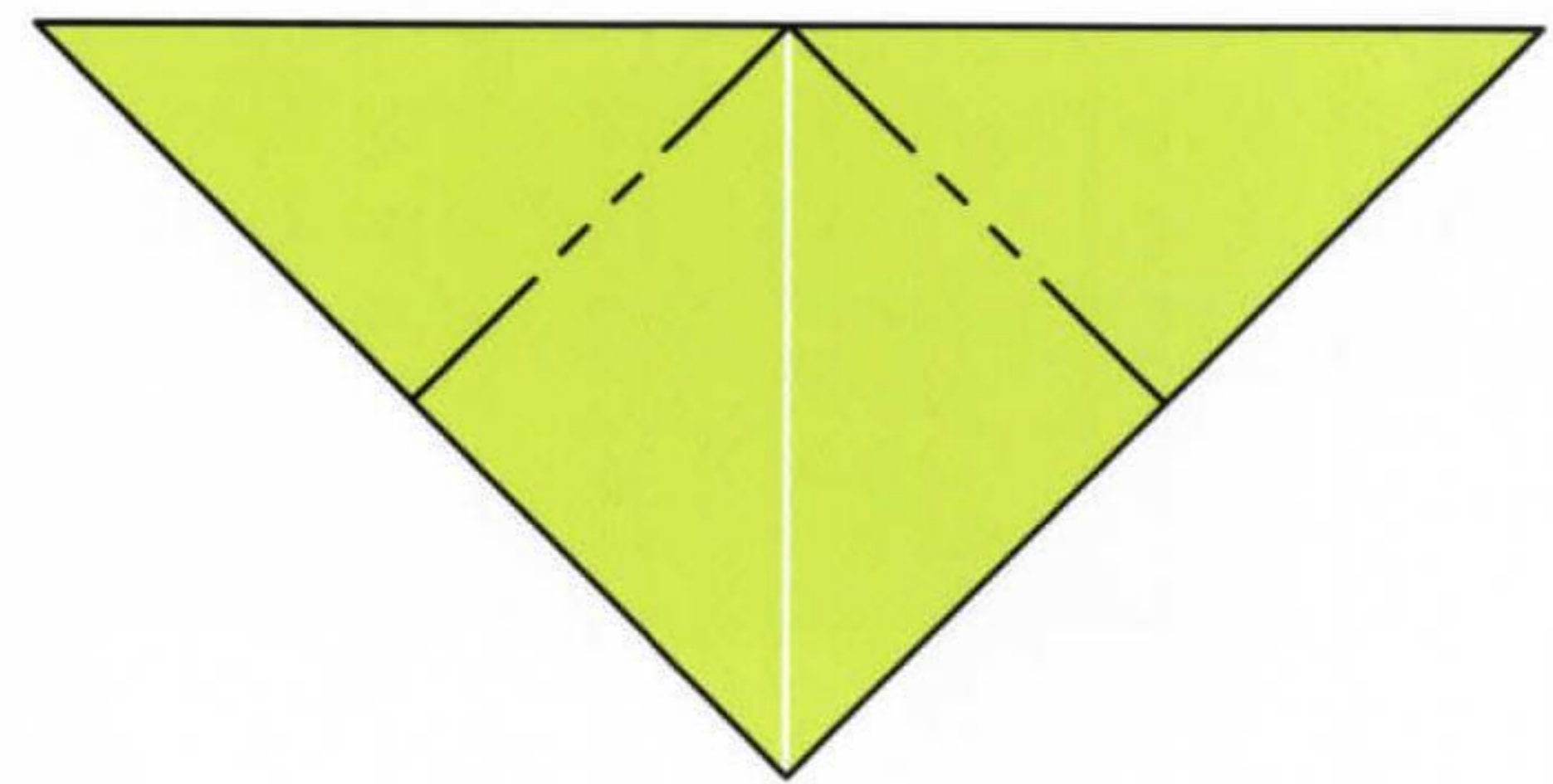

3. Inside reverse folds

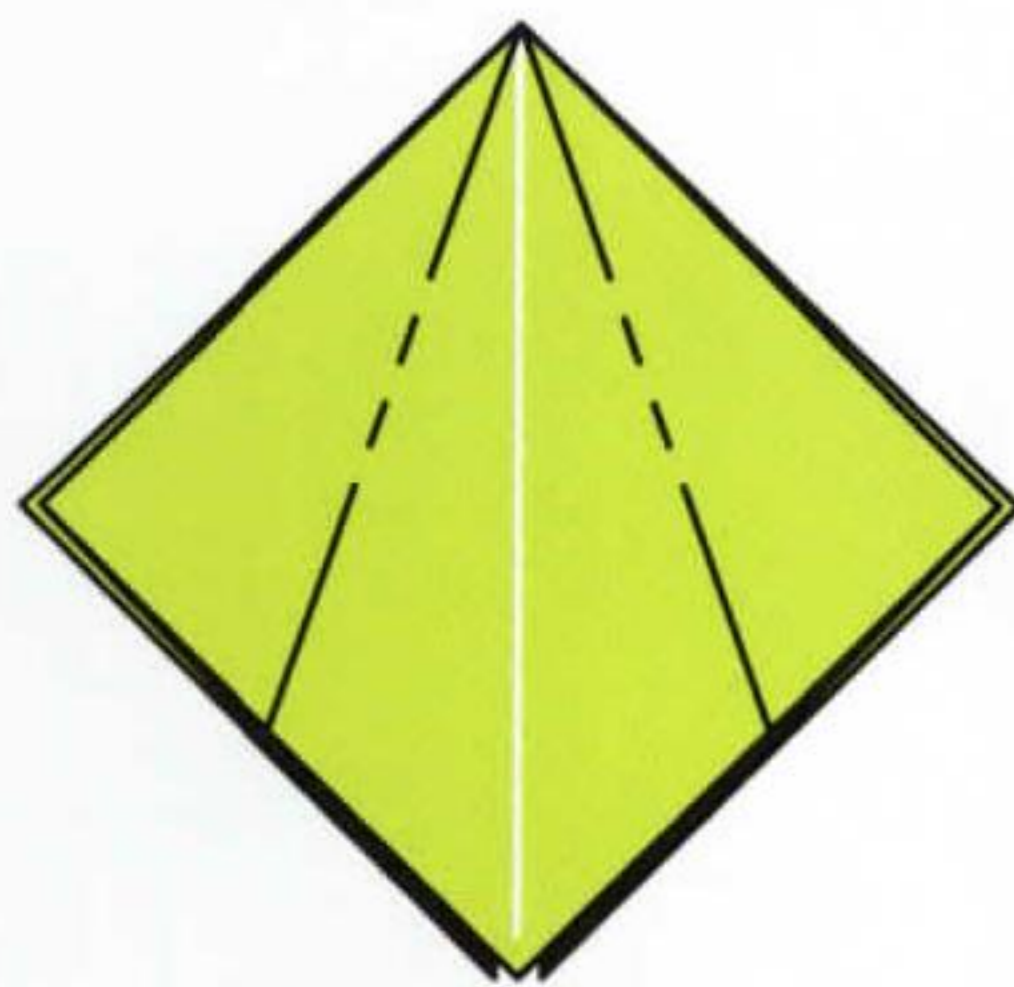

4. Inside reverse folds

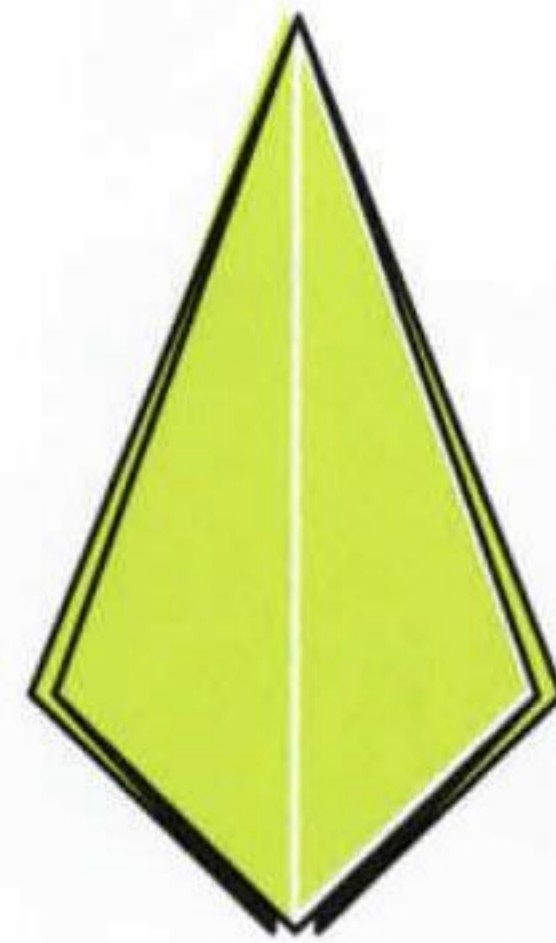

5. Scale-up

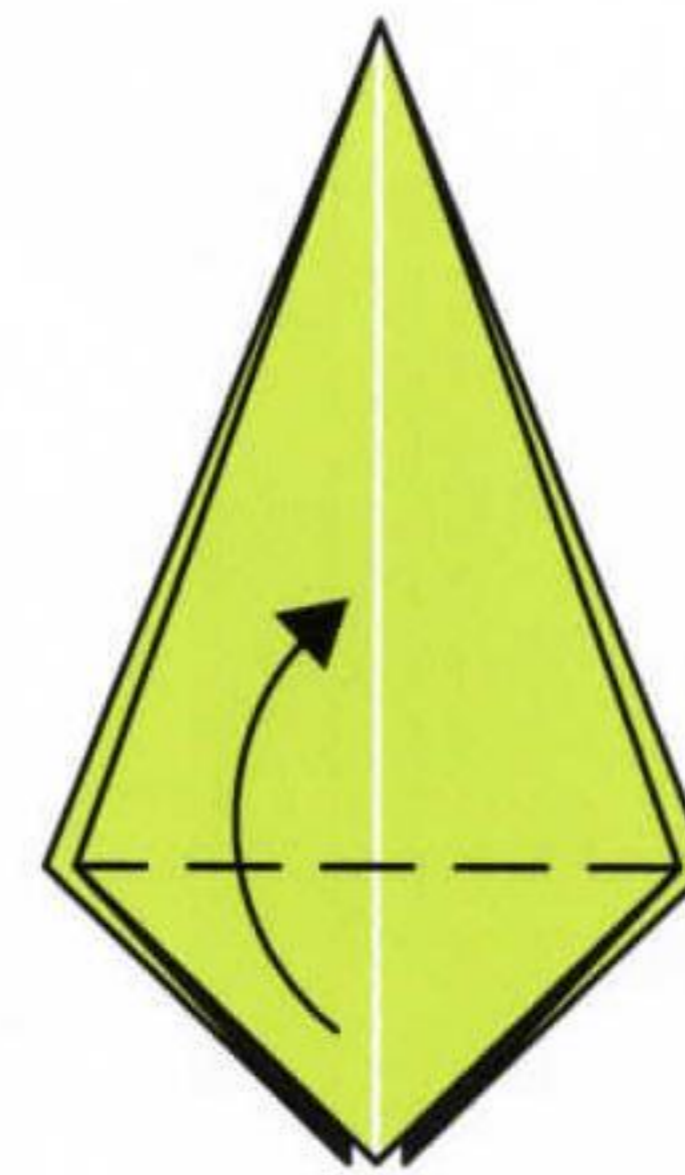

6. Valley fold

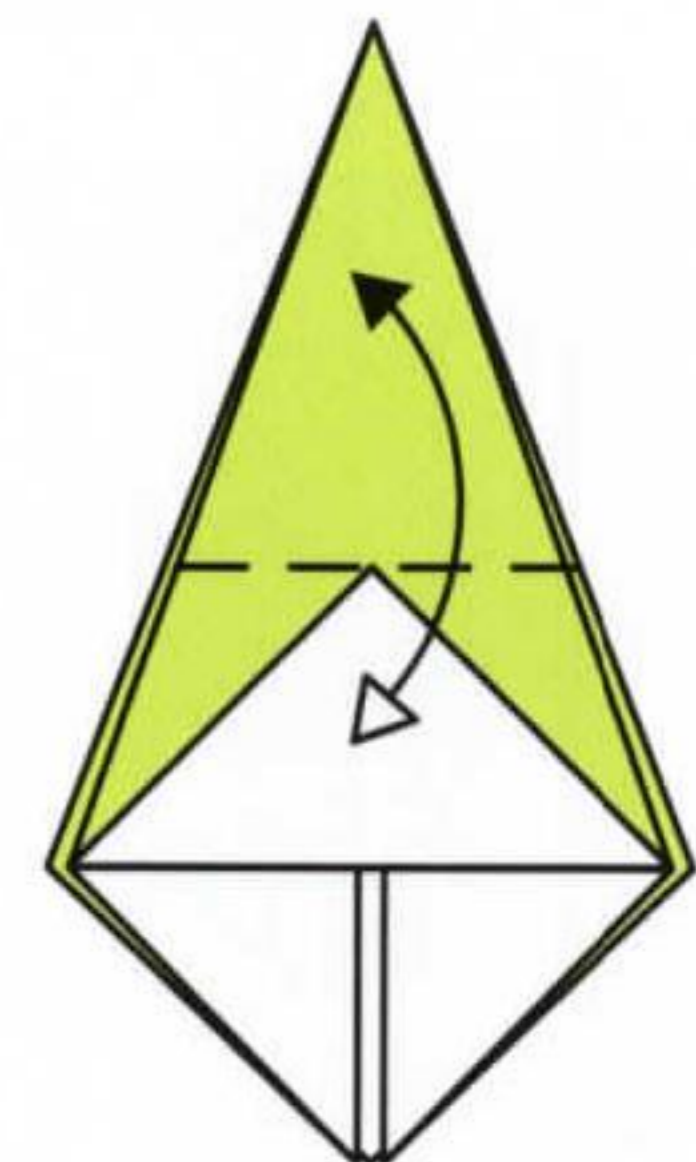

7. Valley fold and unfold



8. Valley fold

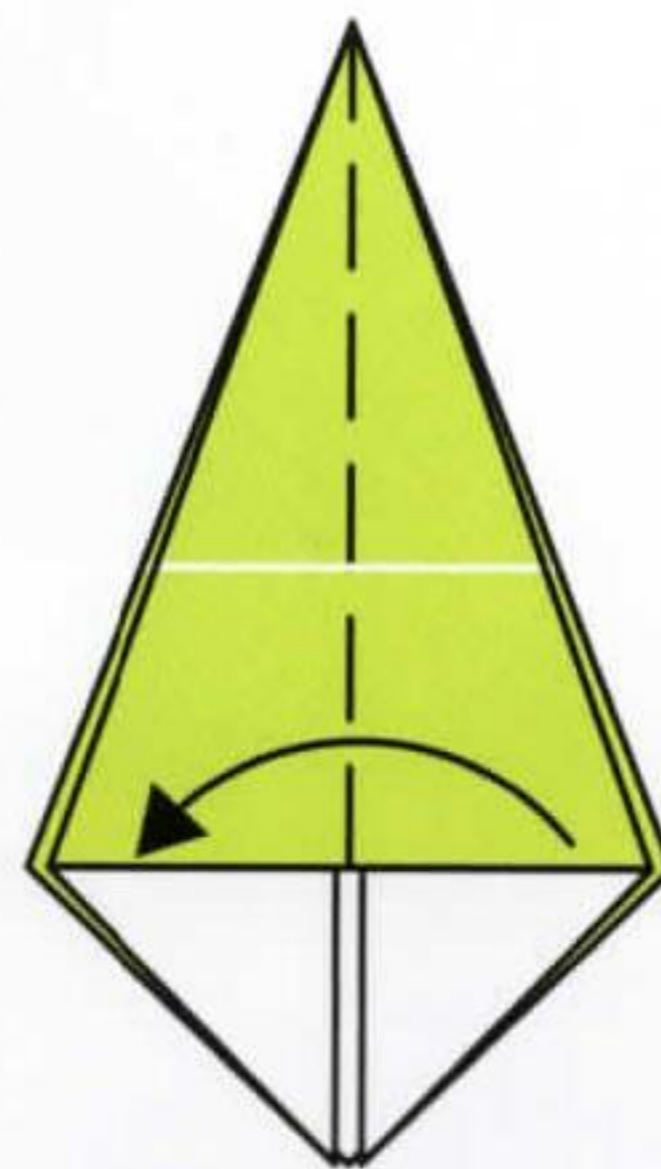

9. Valley fold

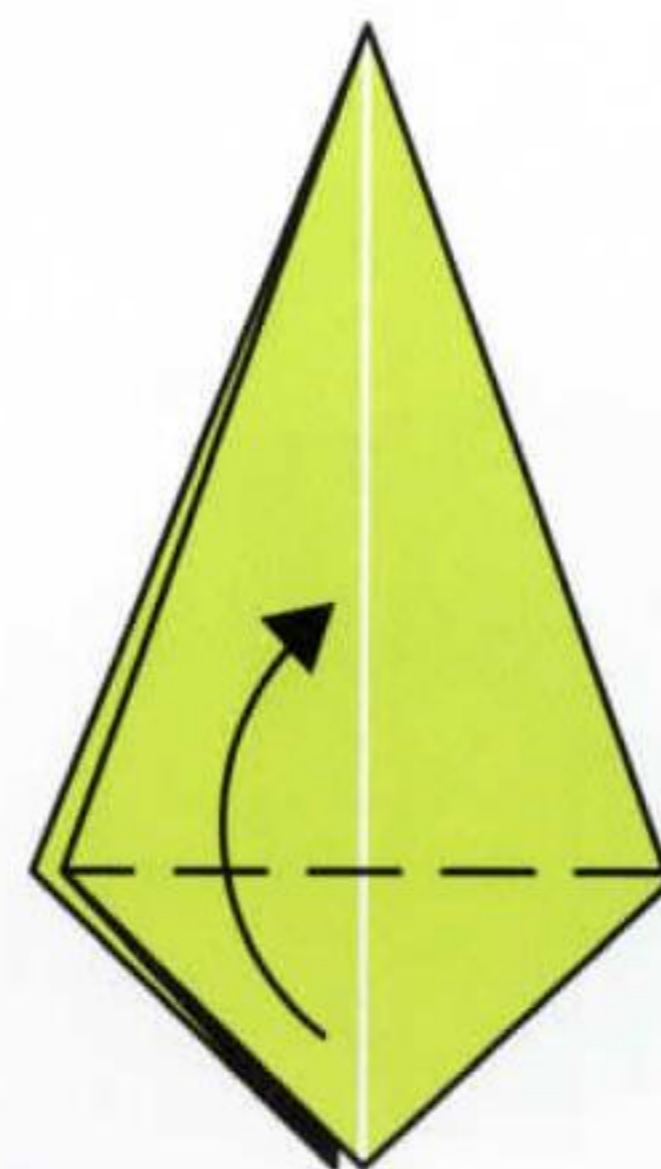

10. Valley fold

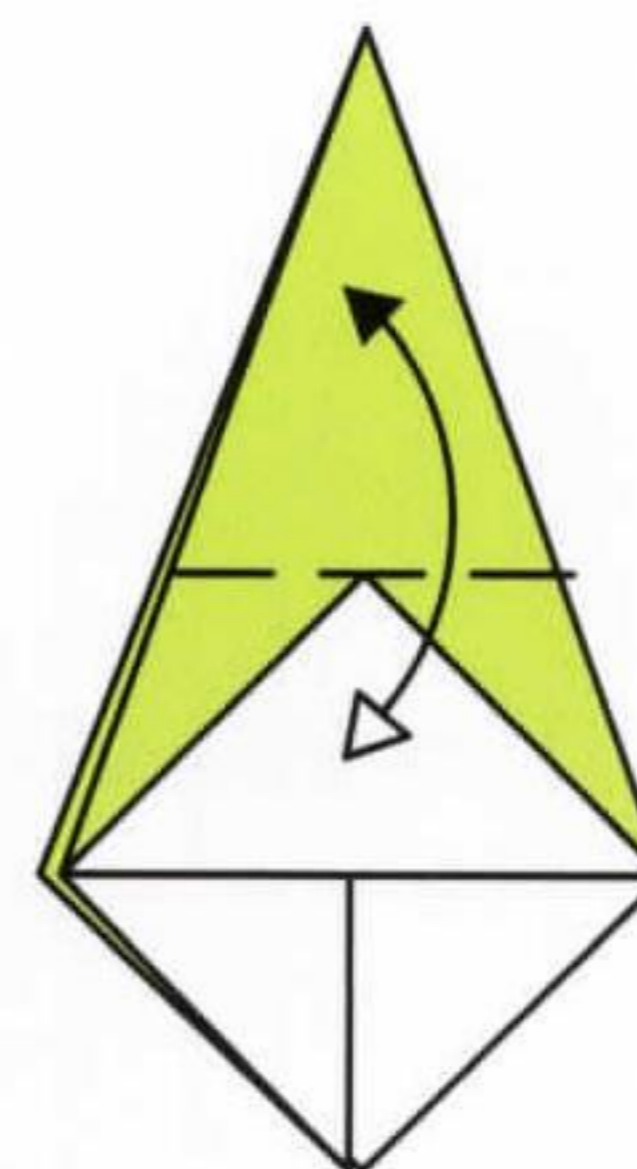

11. Valley fold and unfold

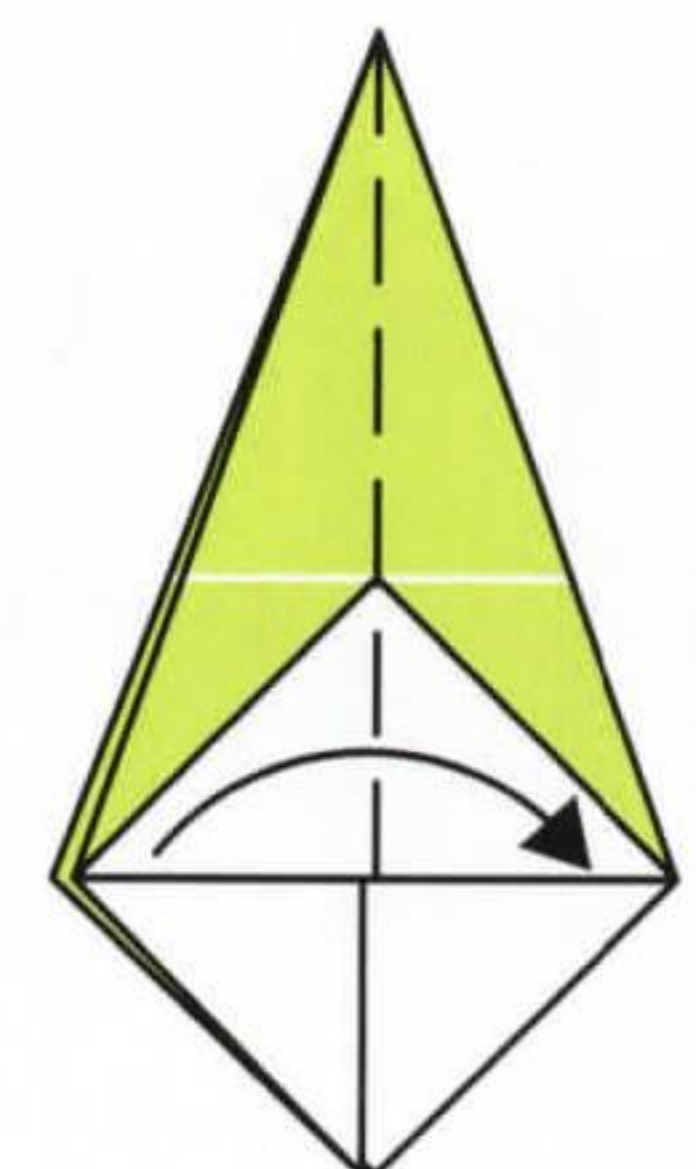

12. Valley fold

table lamp: part 2

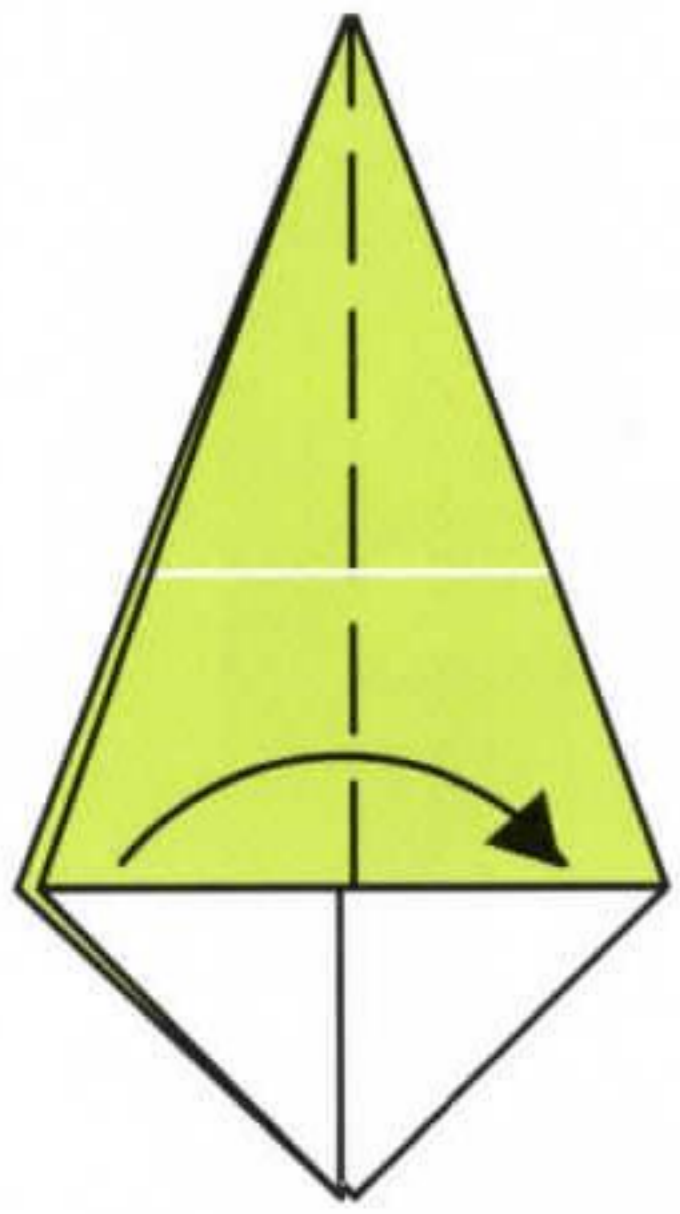

13. Valley fold over flaps

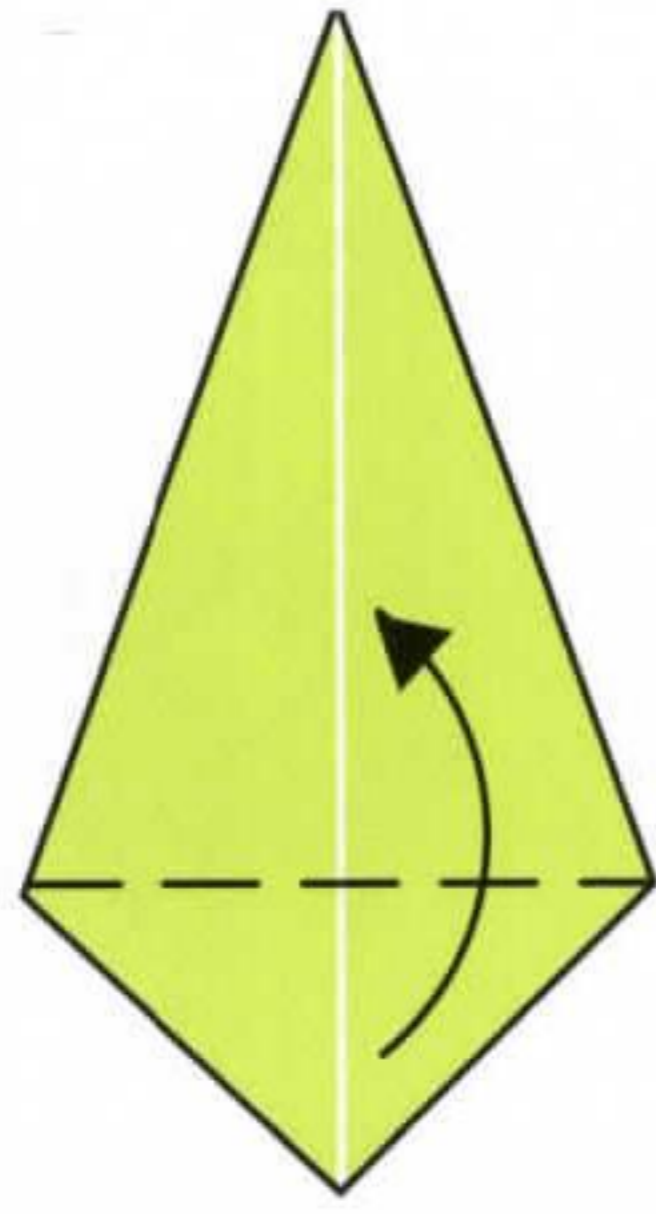

14. Valley fold

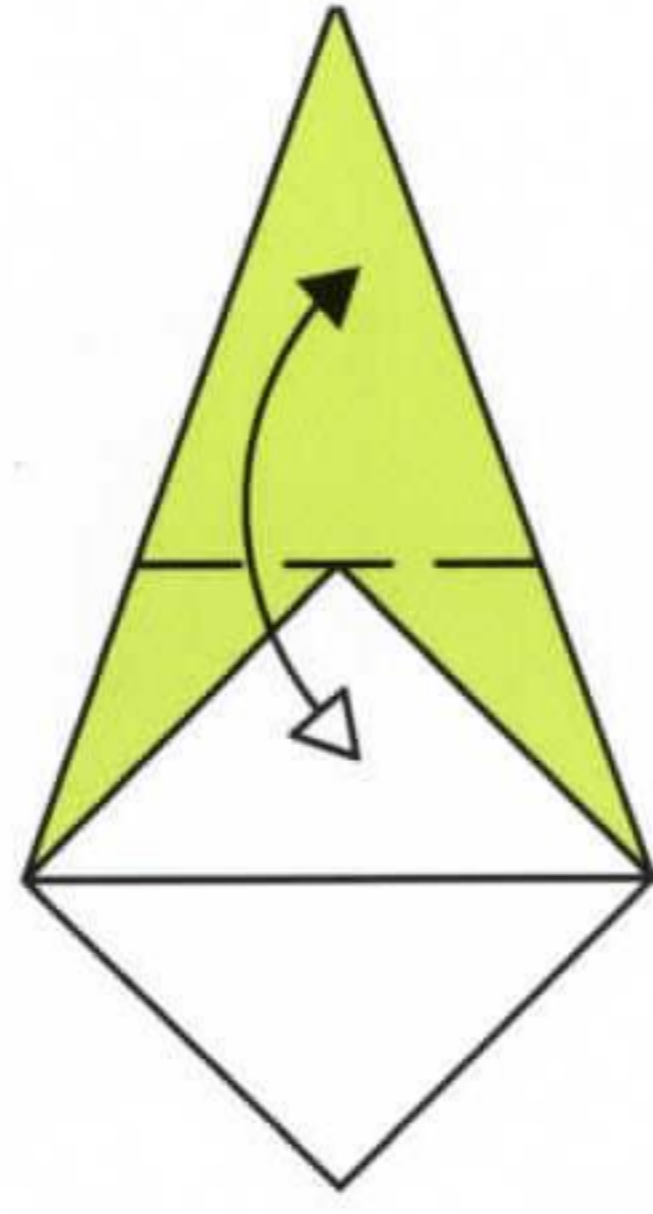

15. Valley fold and unfold

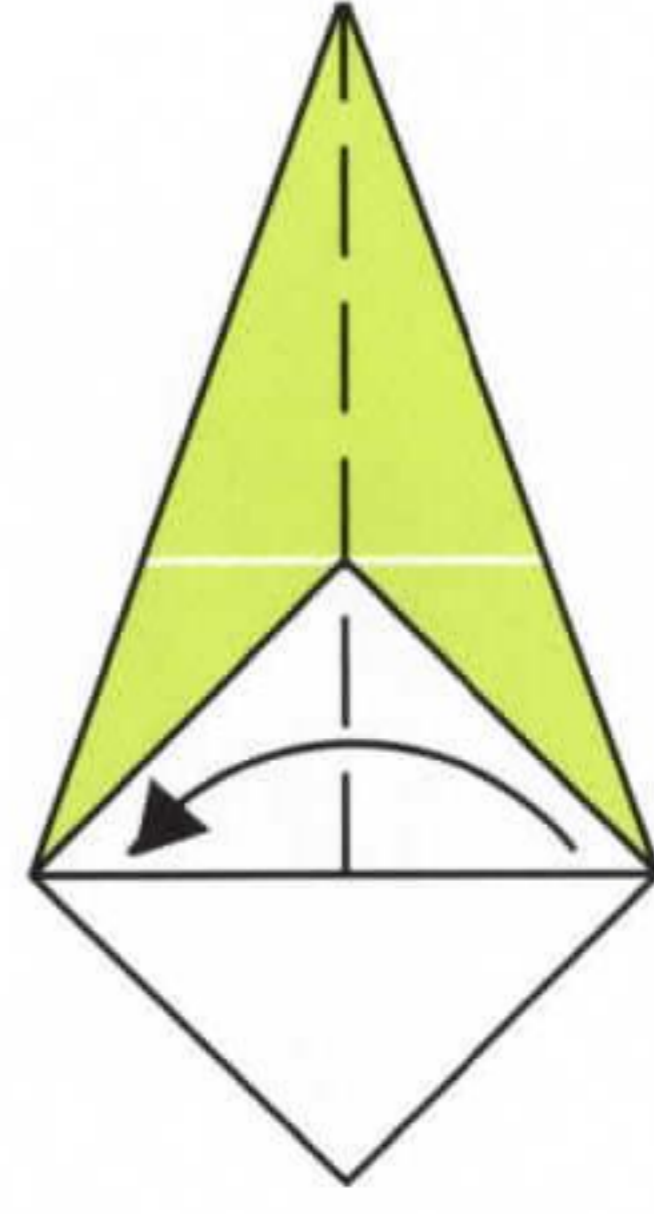

16. Valley fold

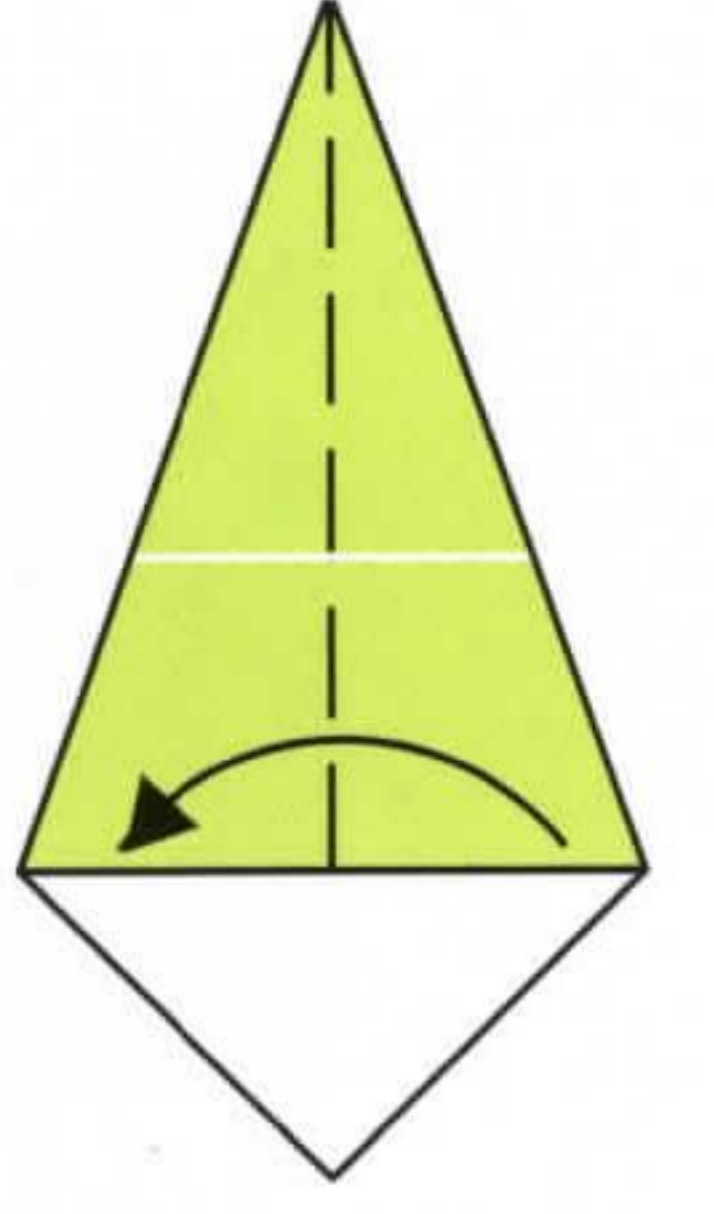

17. Valley fold

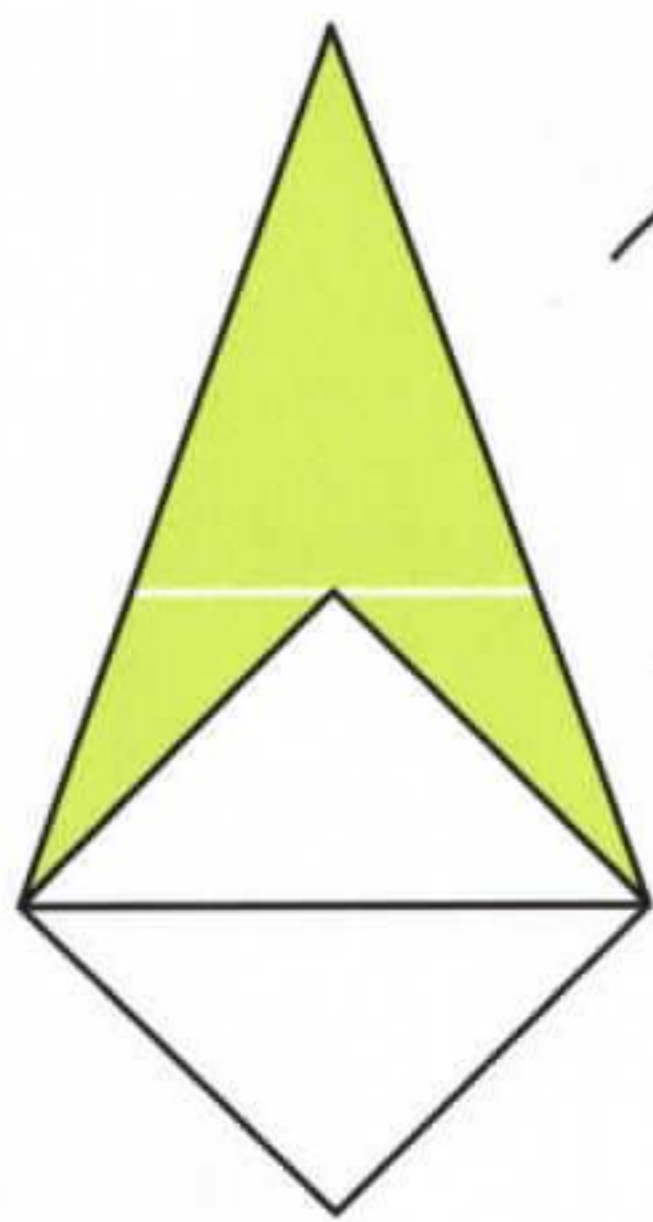

18. Turn over

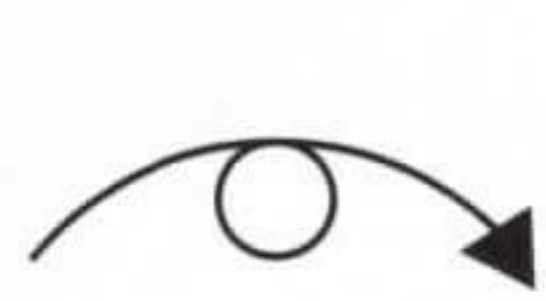

19. Valley fold

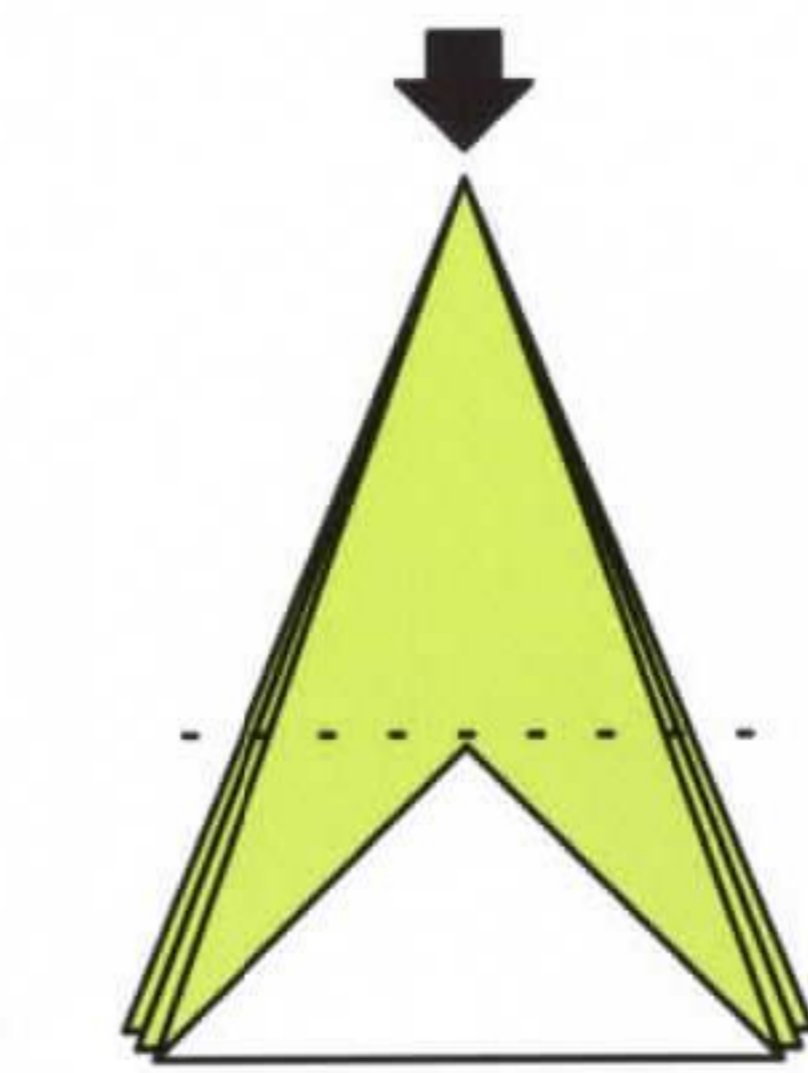
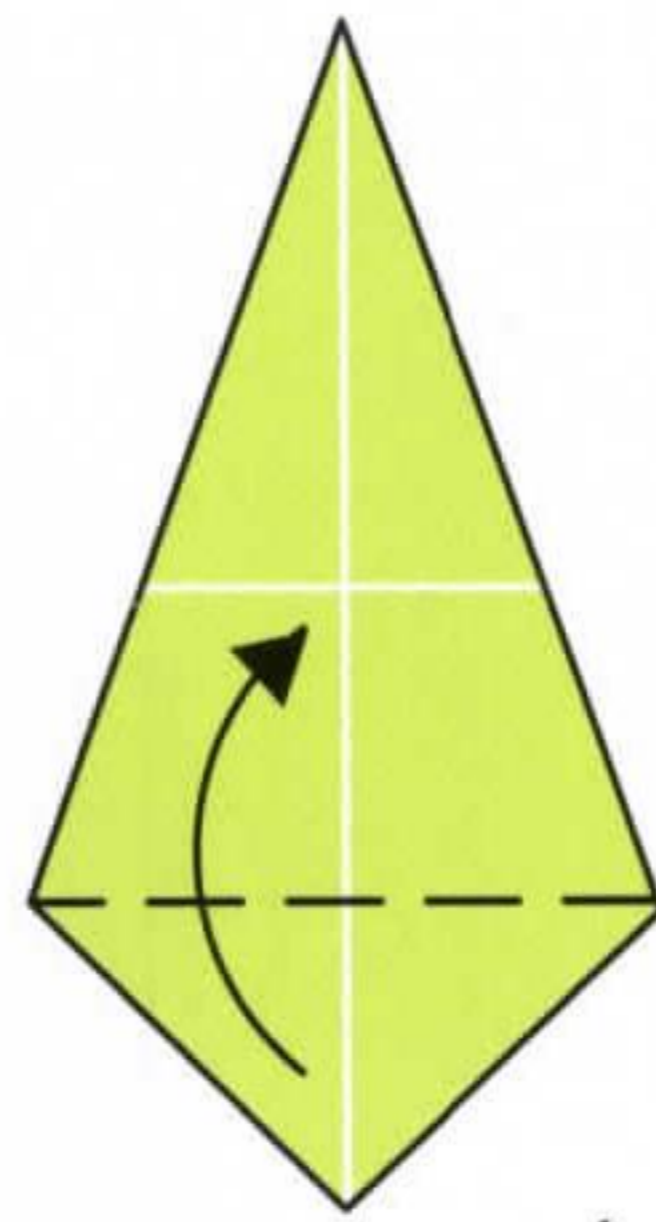

20. Sink fold

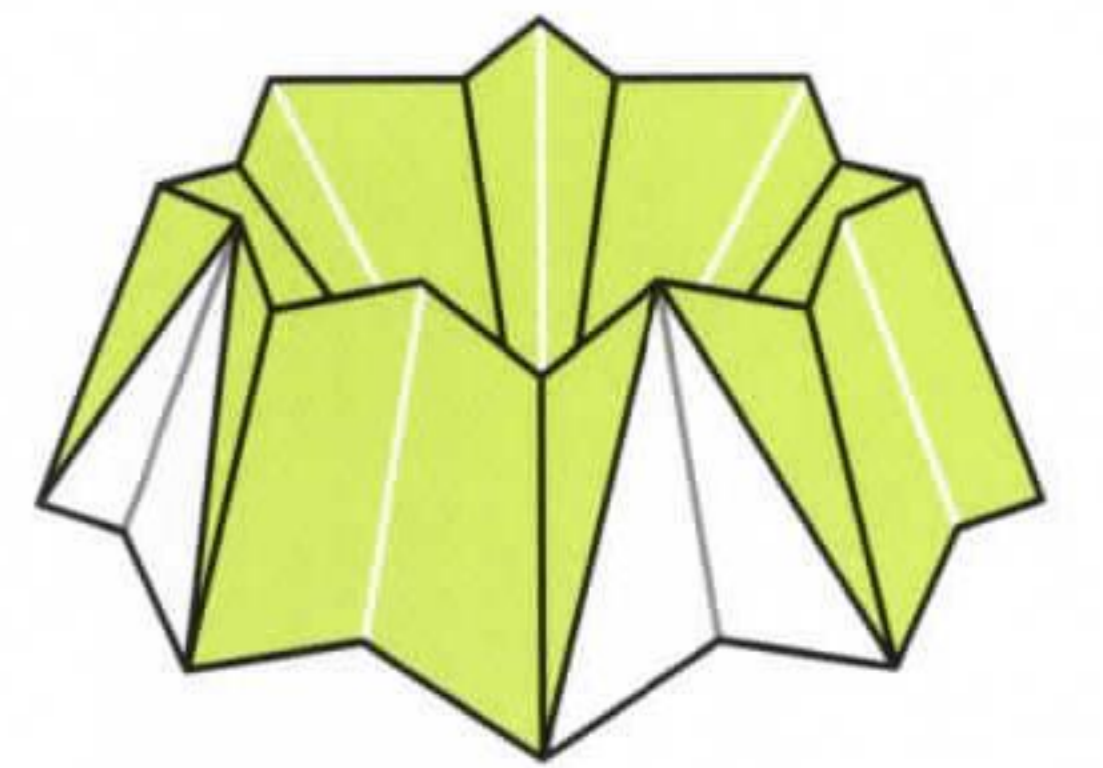

21. Before complete



22. Completed PART 2

ASSEMBLY

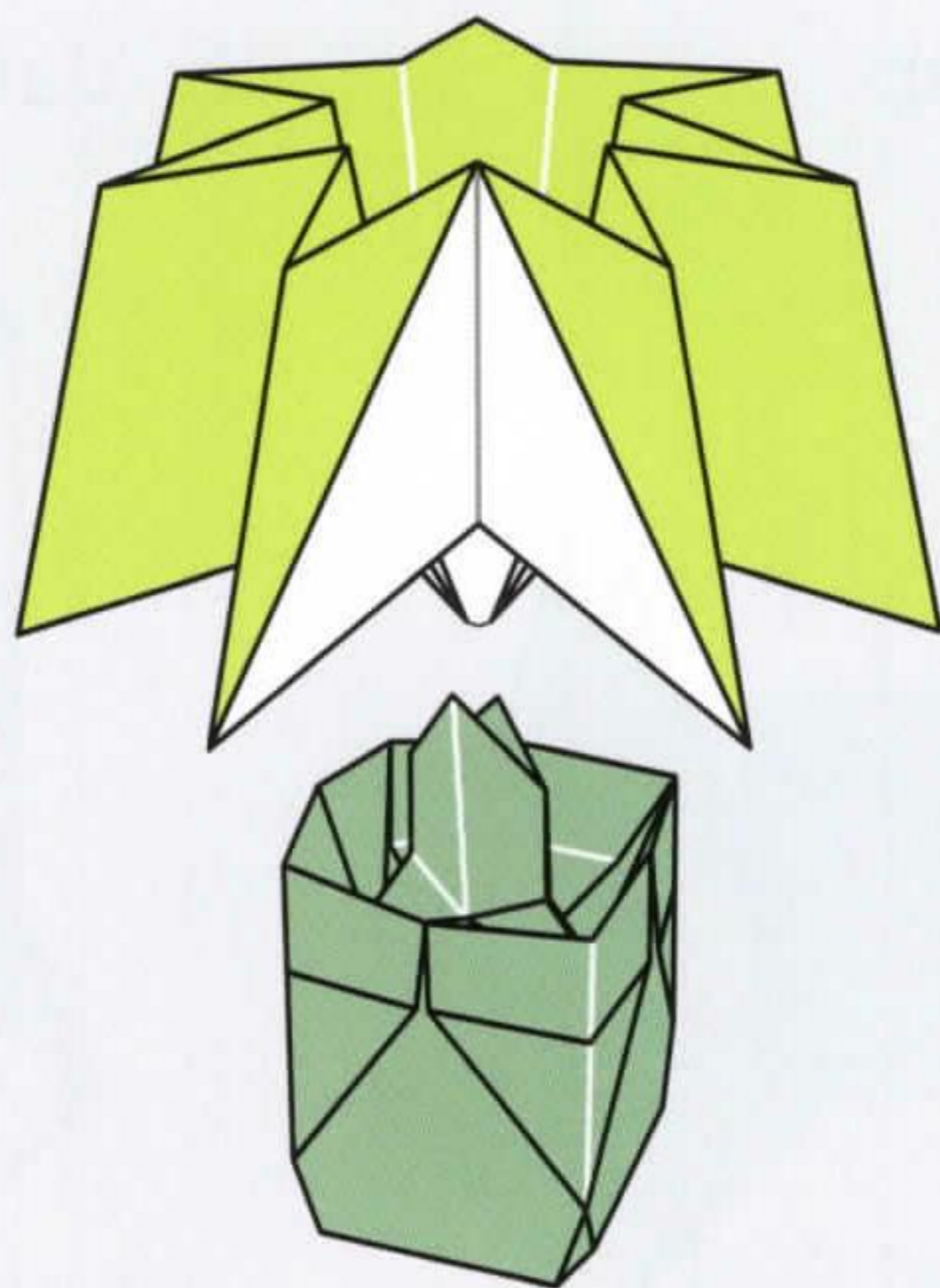

1. Insert PART 1 into PART 2 as shown and apply glue to hold

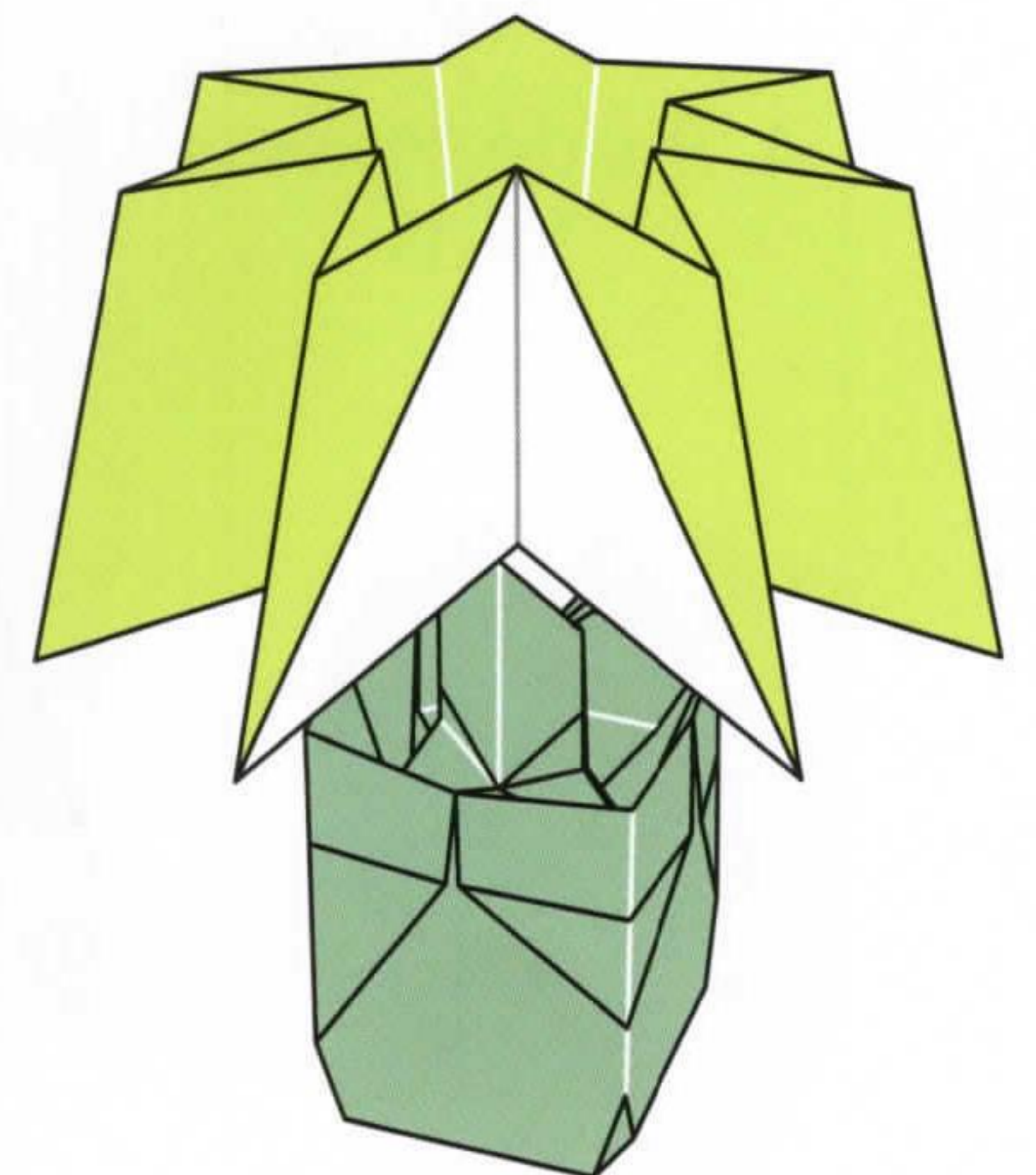

2. Completed TABLE LAMP

► telephone: part 1

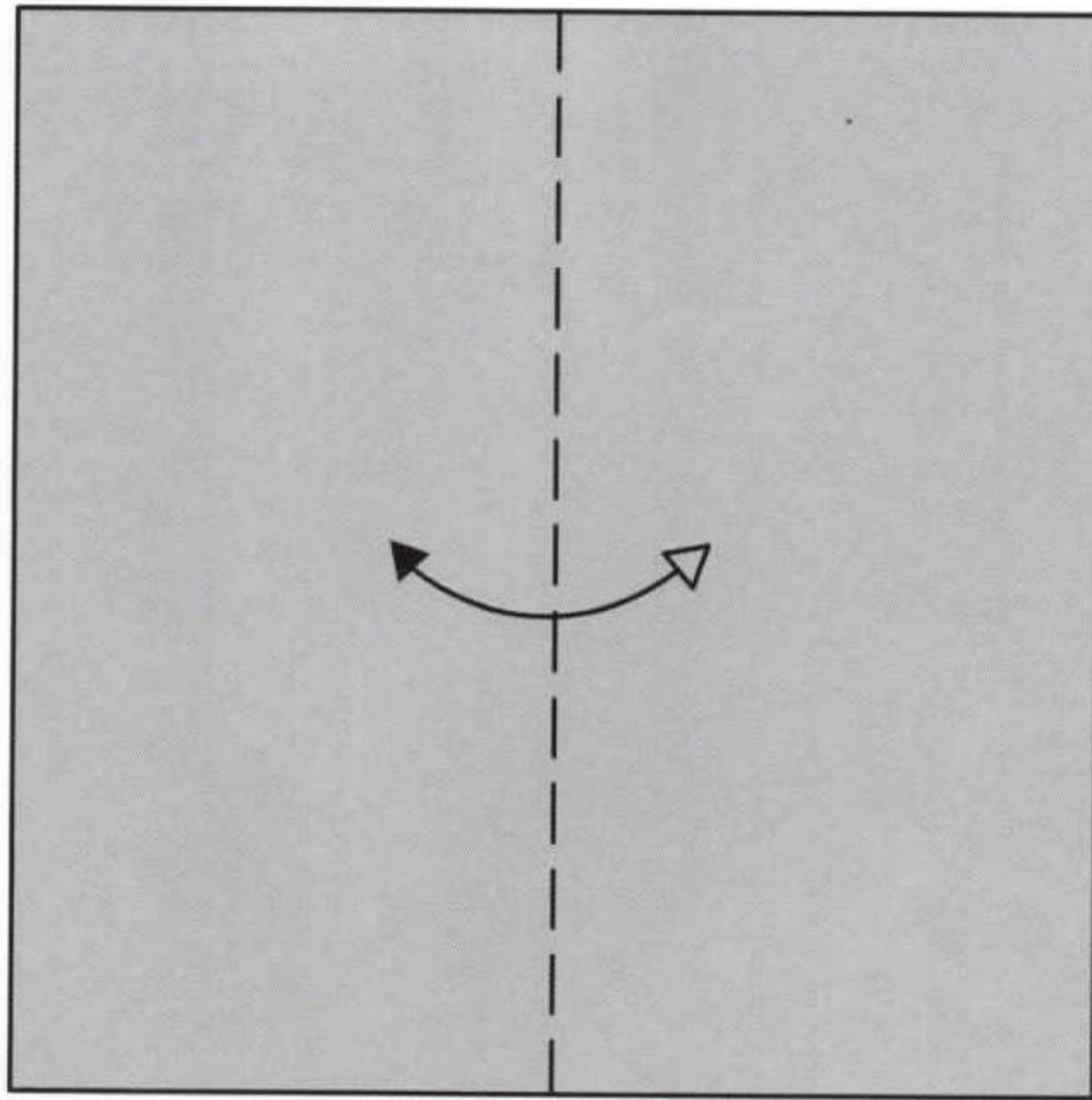

1. Use 4 x 4 instead of 8 x 8 square. Valley fold and unfold

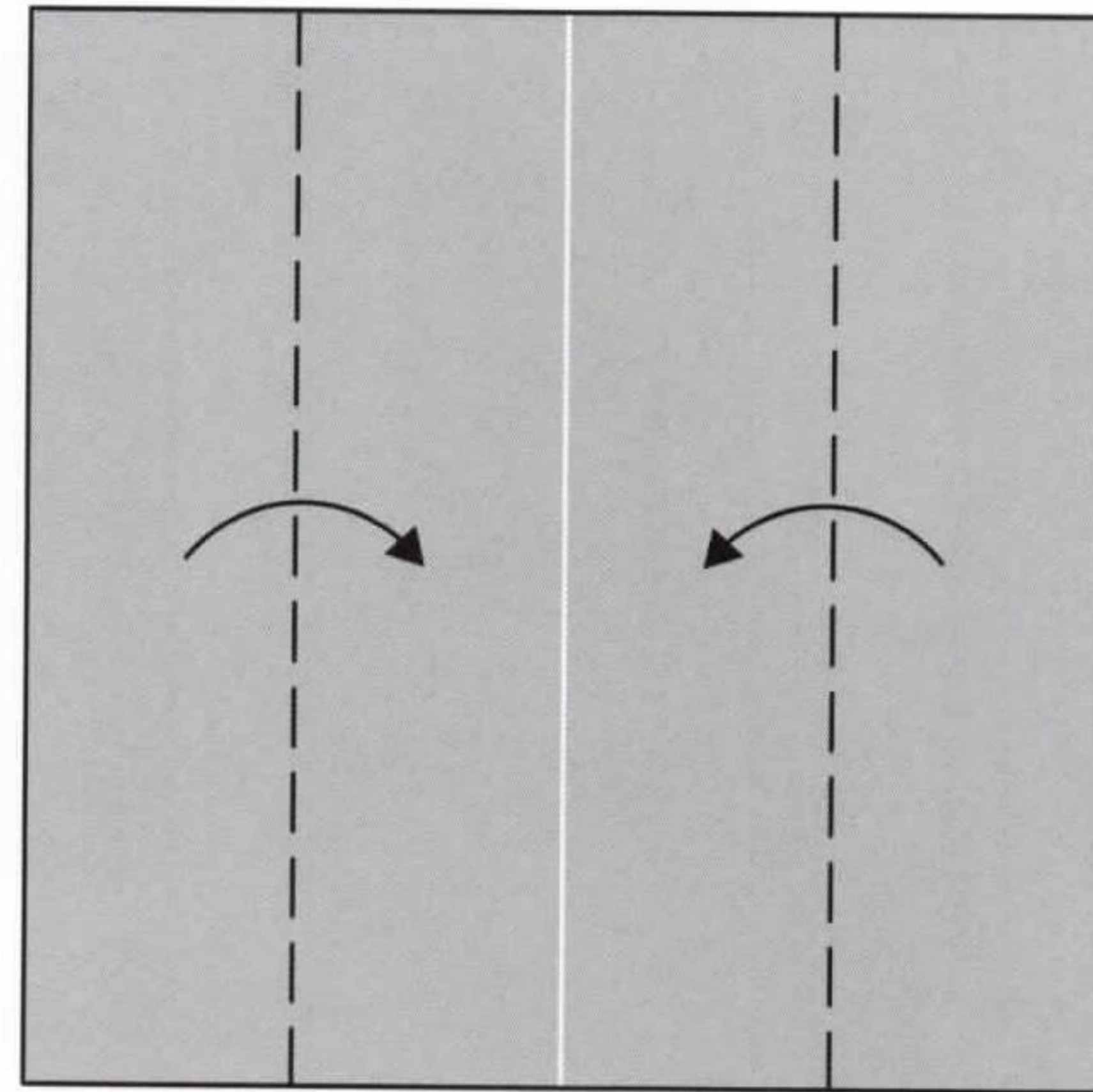

2. Valley folds

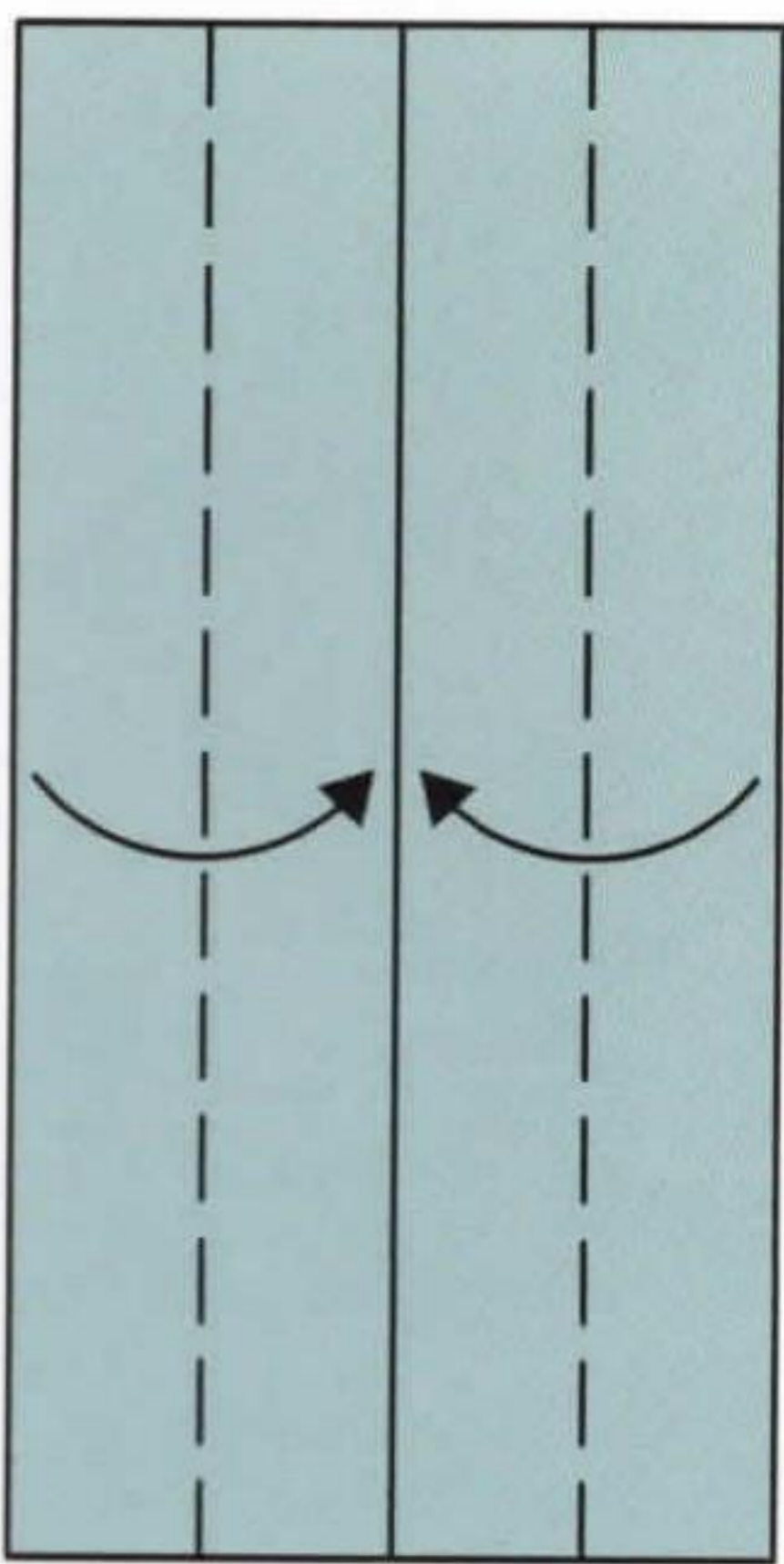

3. Valley folds

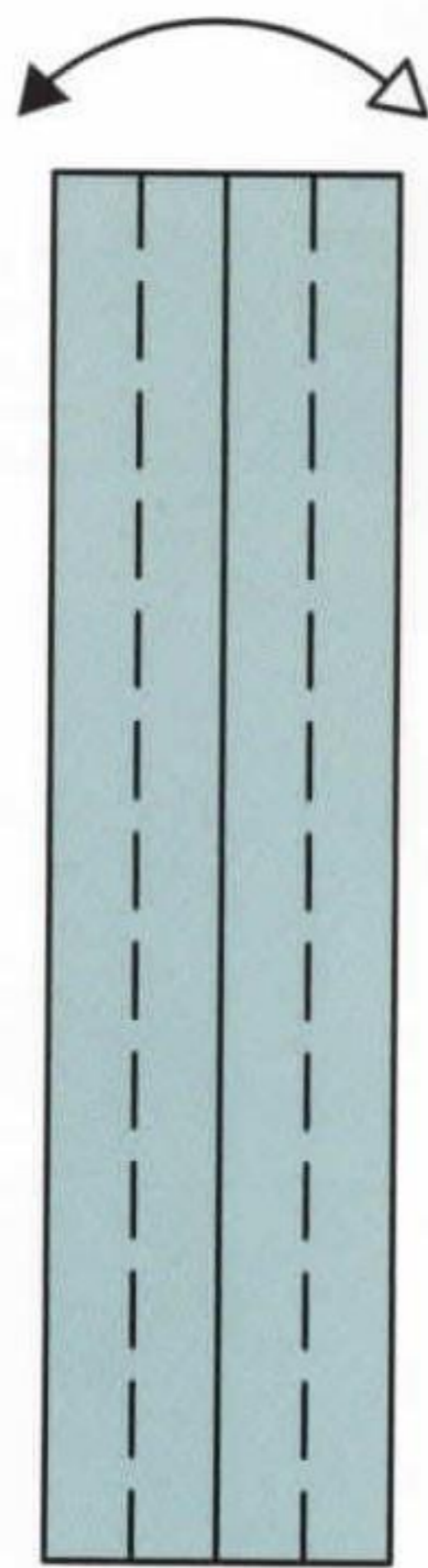

4. Valley folds and unfold

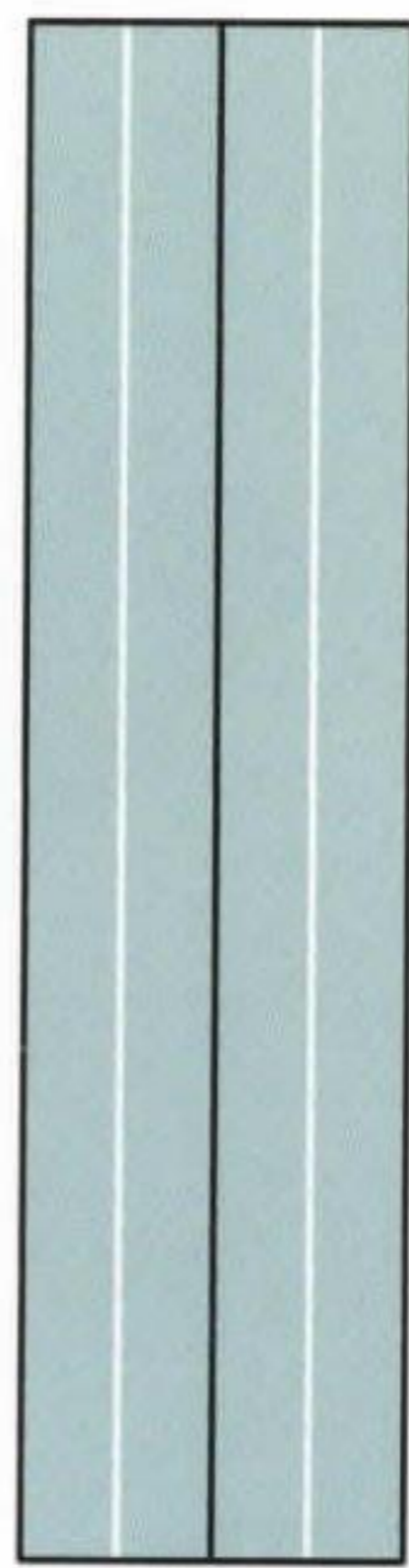

5. Scale-up

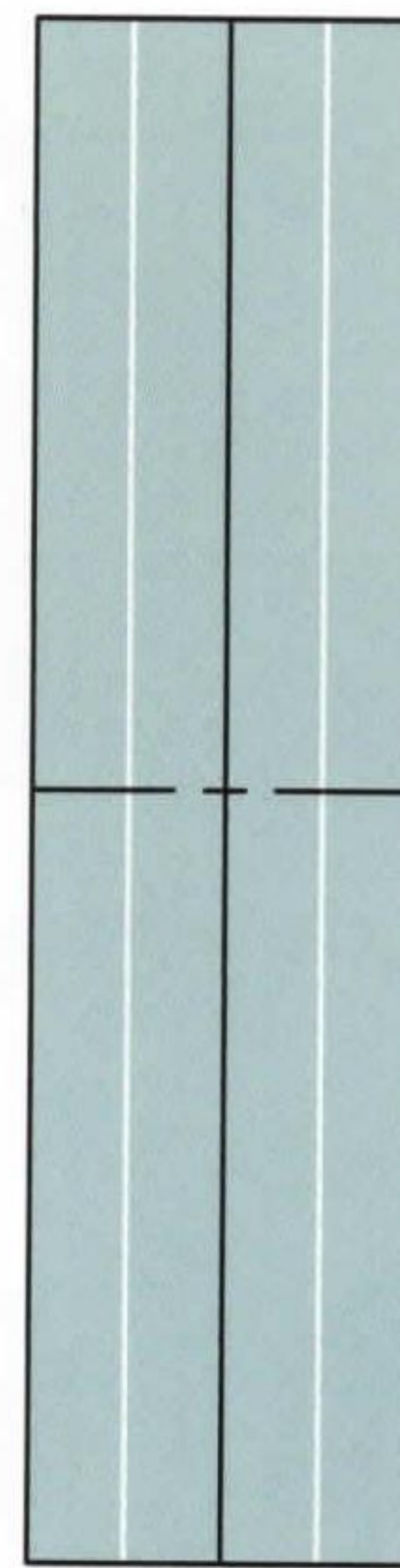

6. Mountain fold

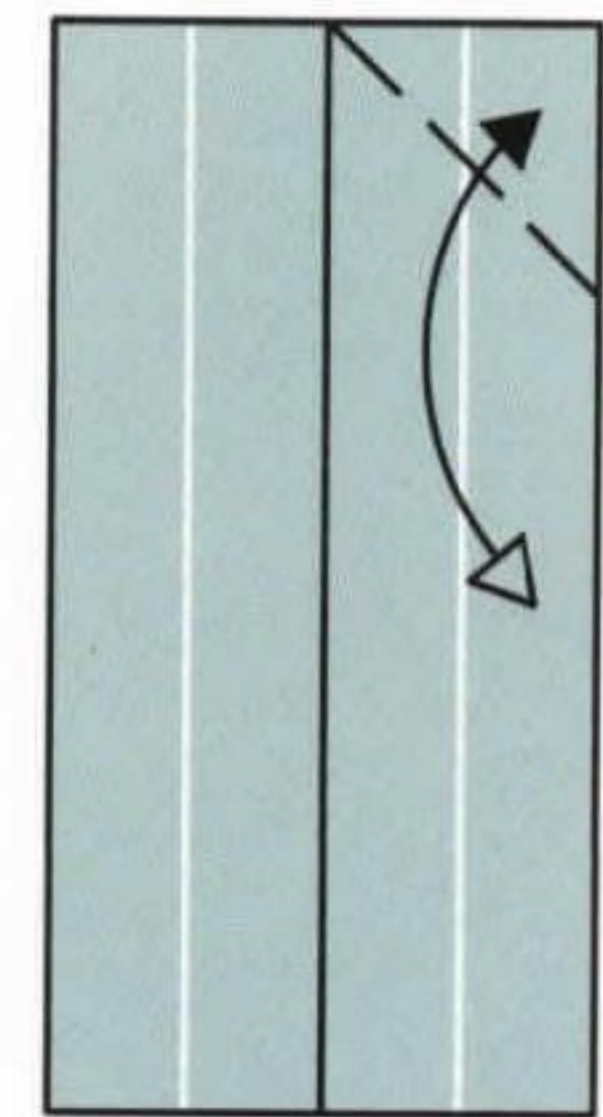

7. Valley fold and unfold

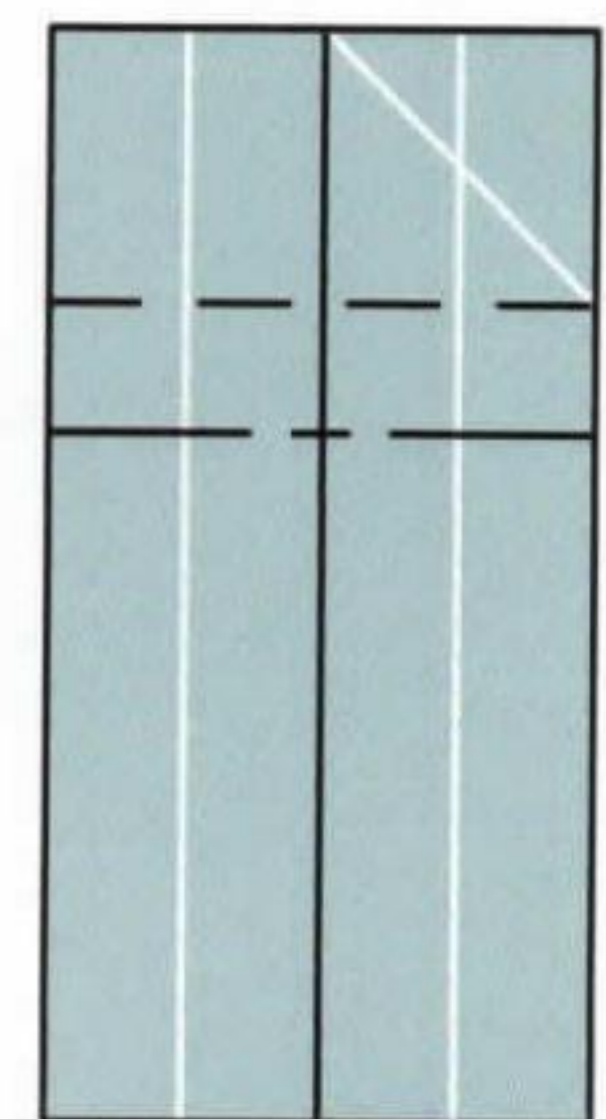

8. Pleat fold

telephone: part 1

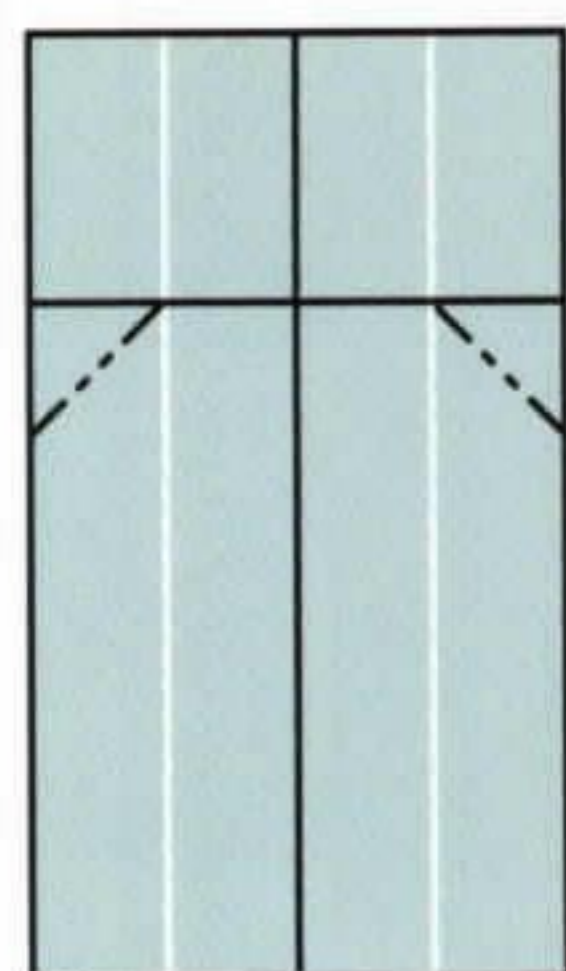

9. Inside reverse folds

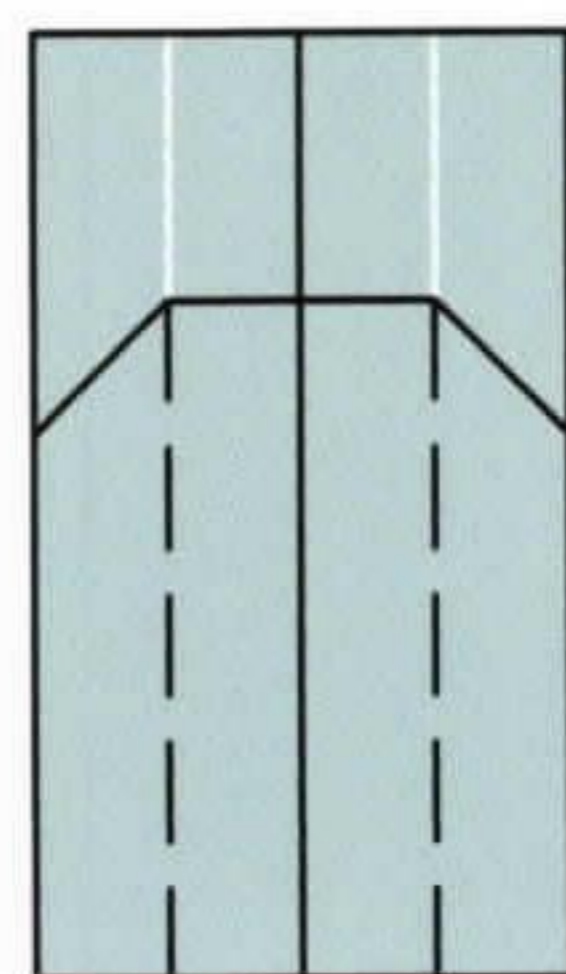

10. Valley folds

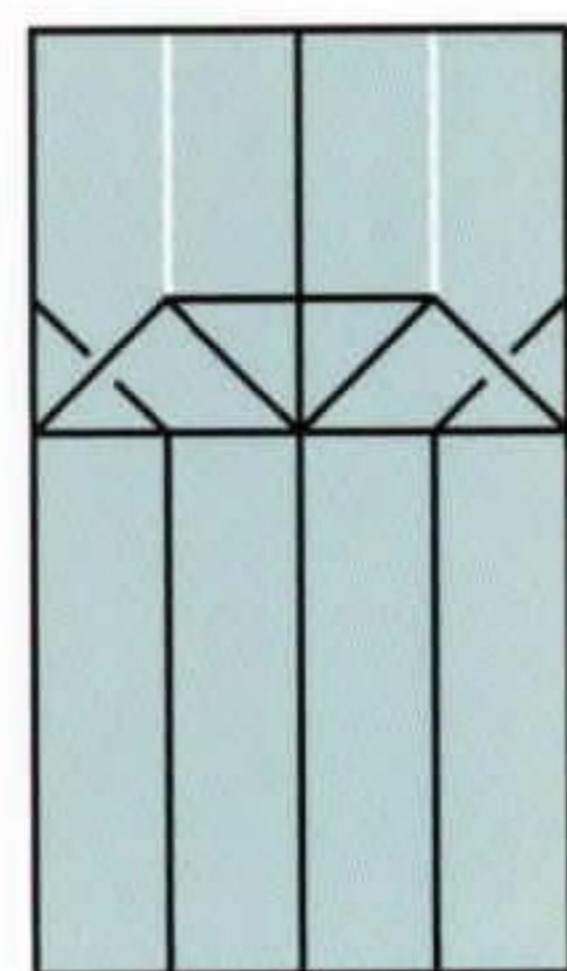

11. Valley folds

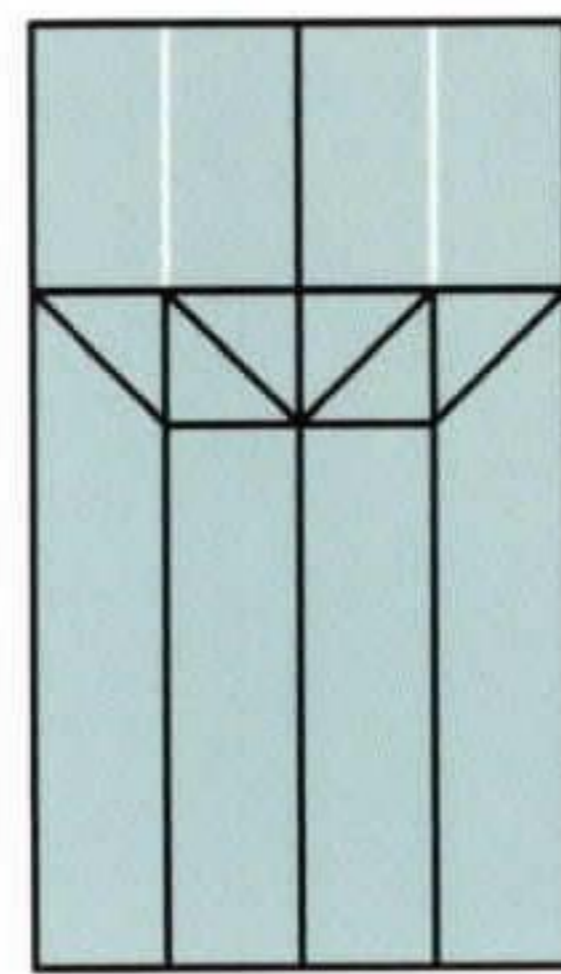

12. Turn over

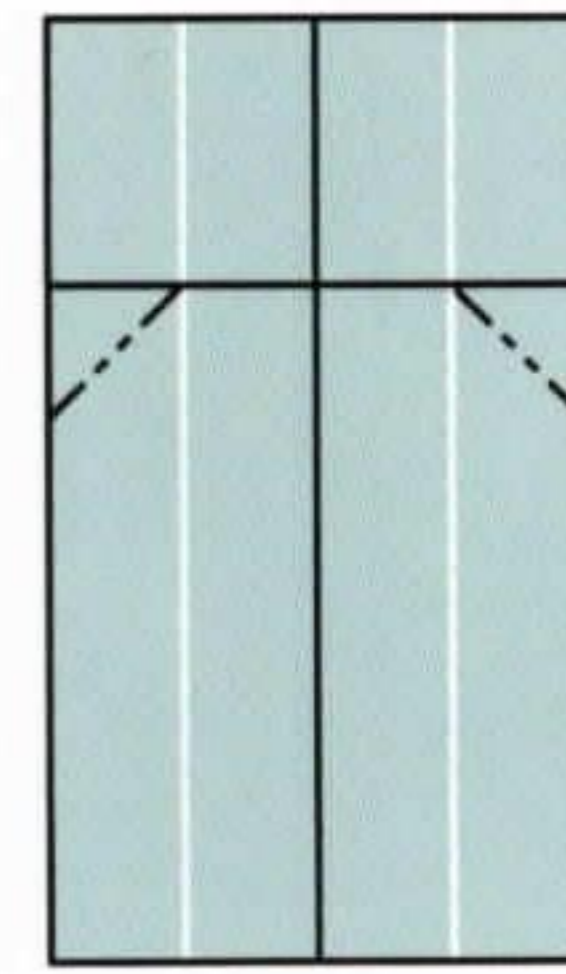

13. Repeat steps 9 to 11

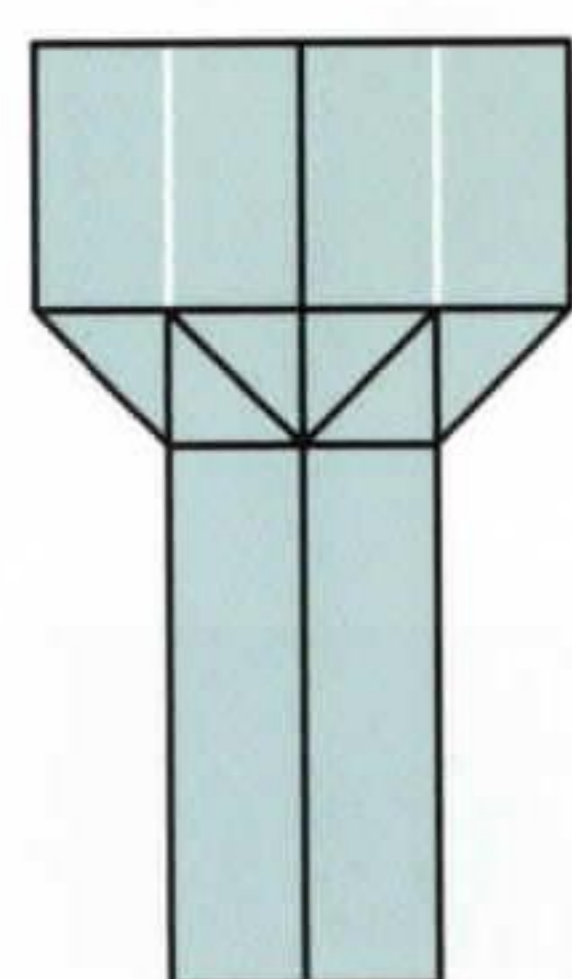

14. Rotate

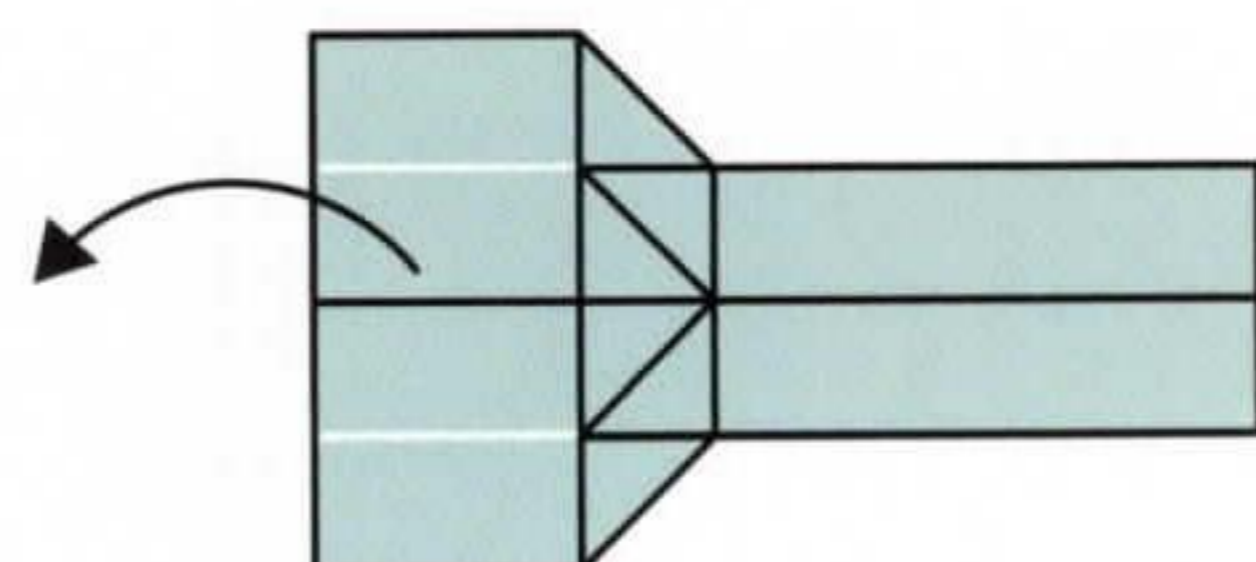
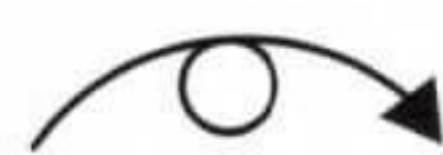

15. Valley fold

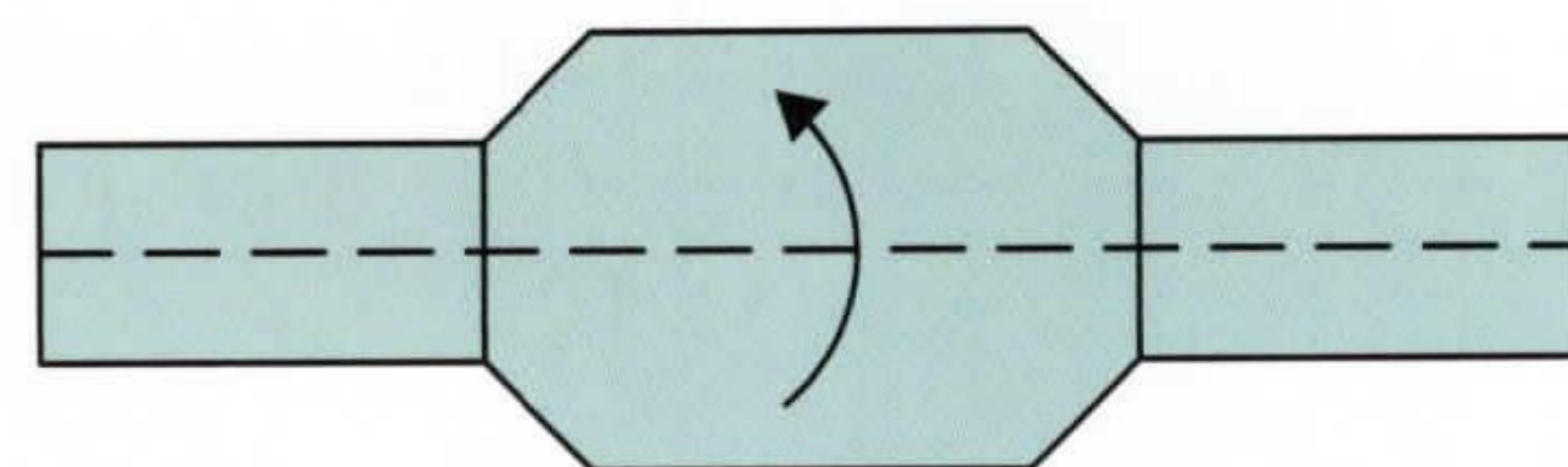

16. Valley fold

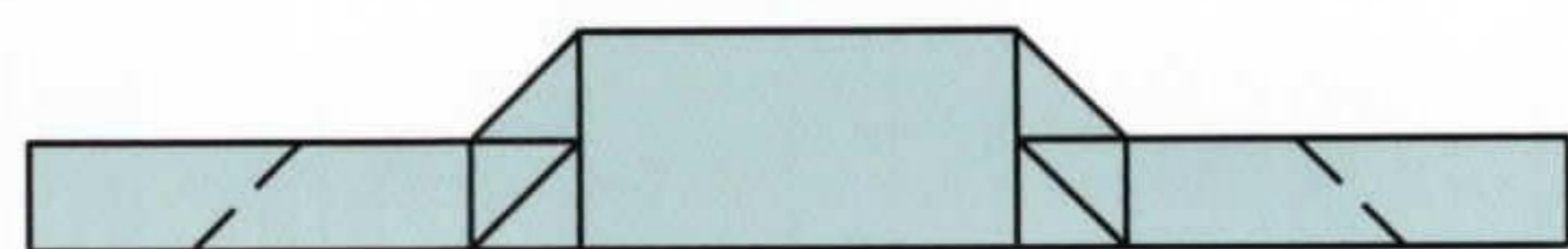

17. Outside reverse folds

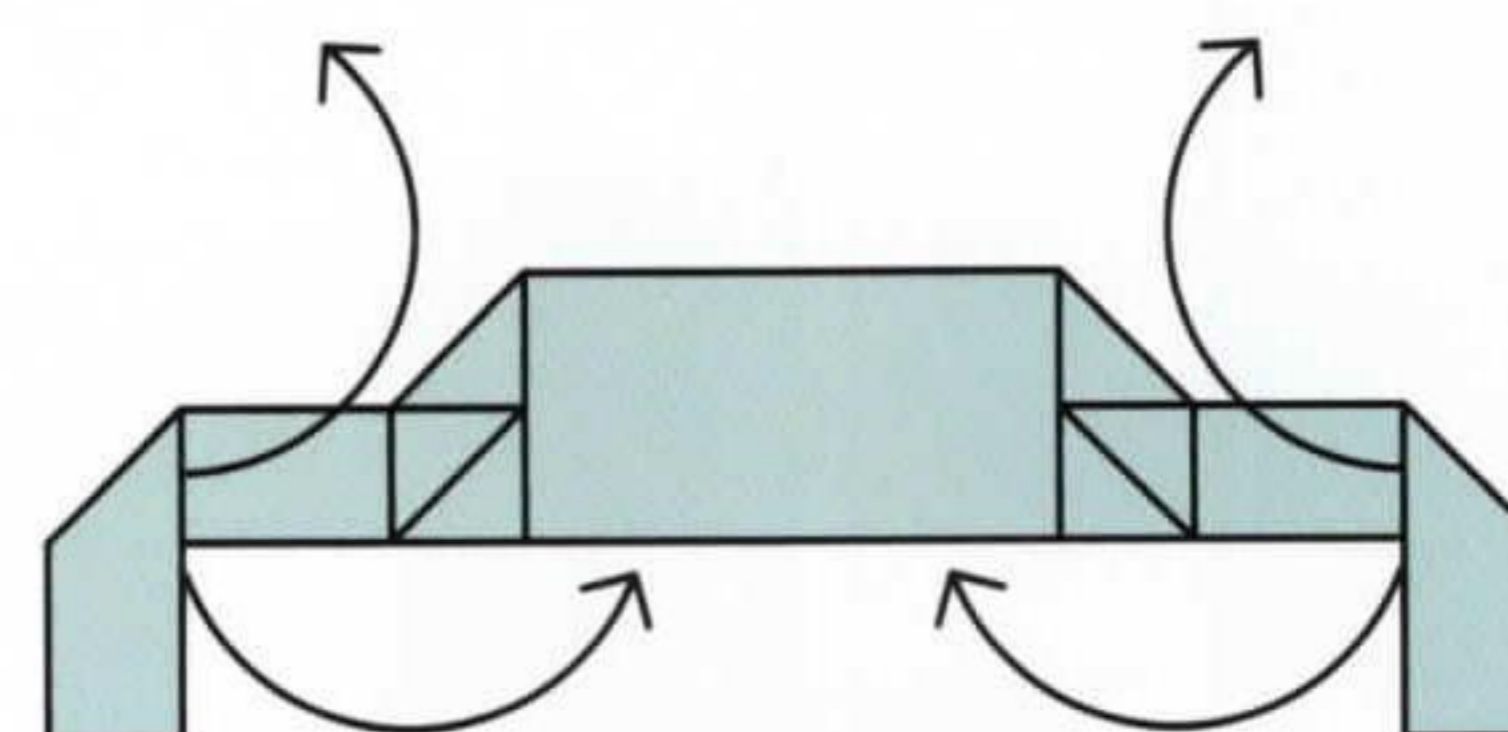

18. Pull out some paper

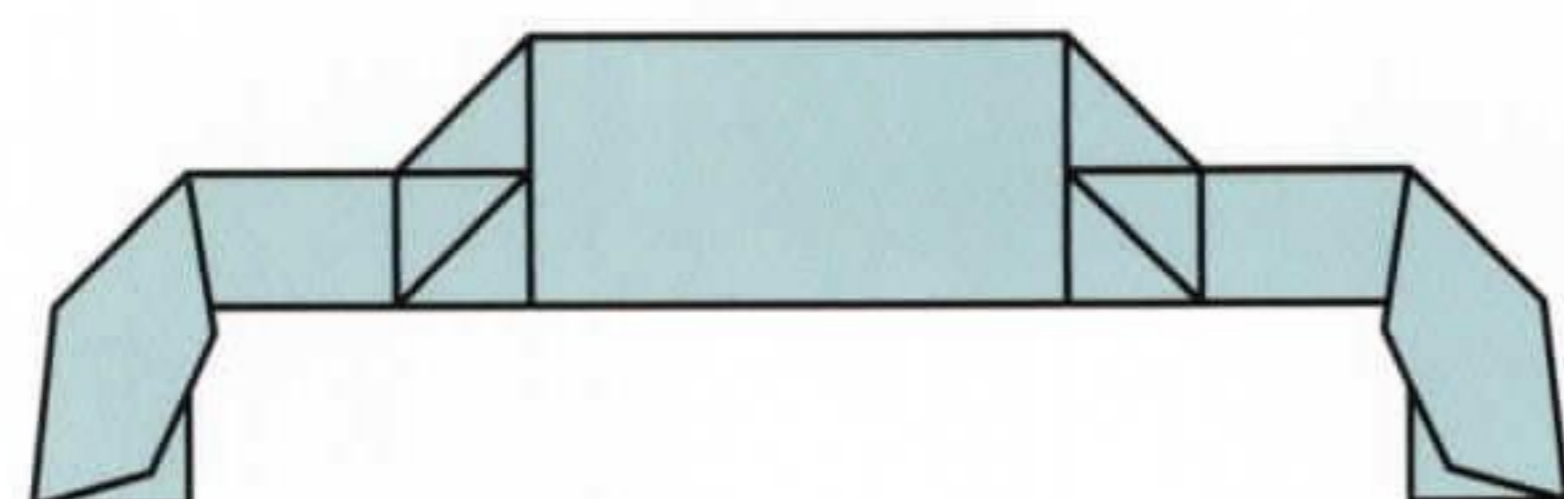

19. Before complete

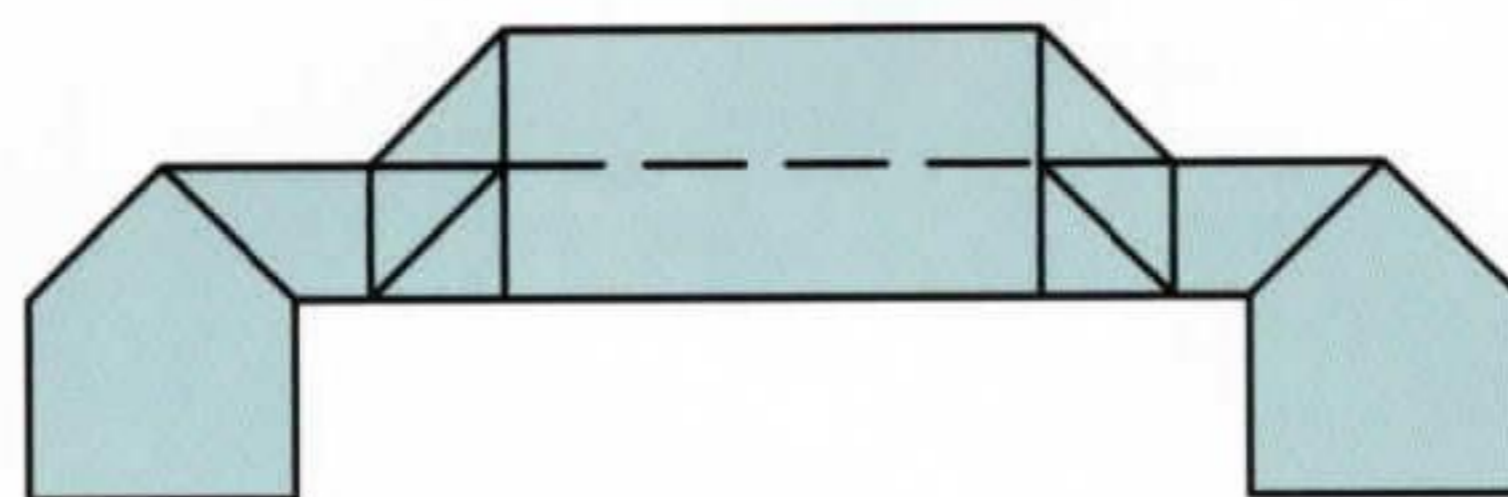

20. Valley fold both sides

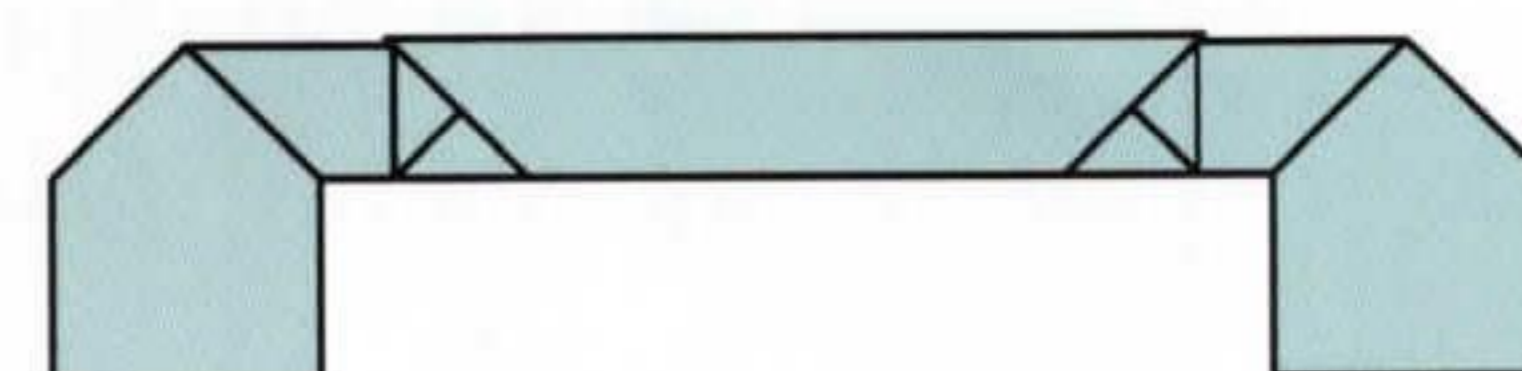

21. Completed PART 1

telephone: part 2

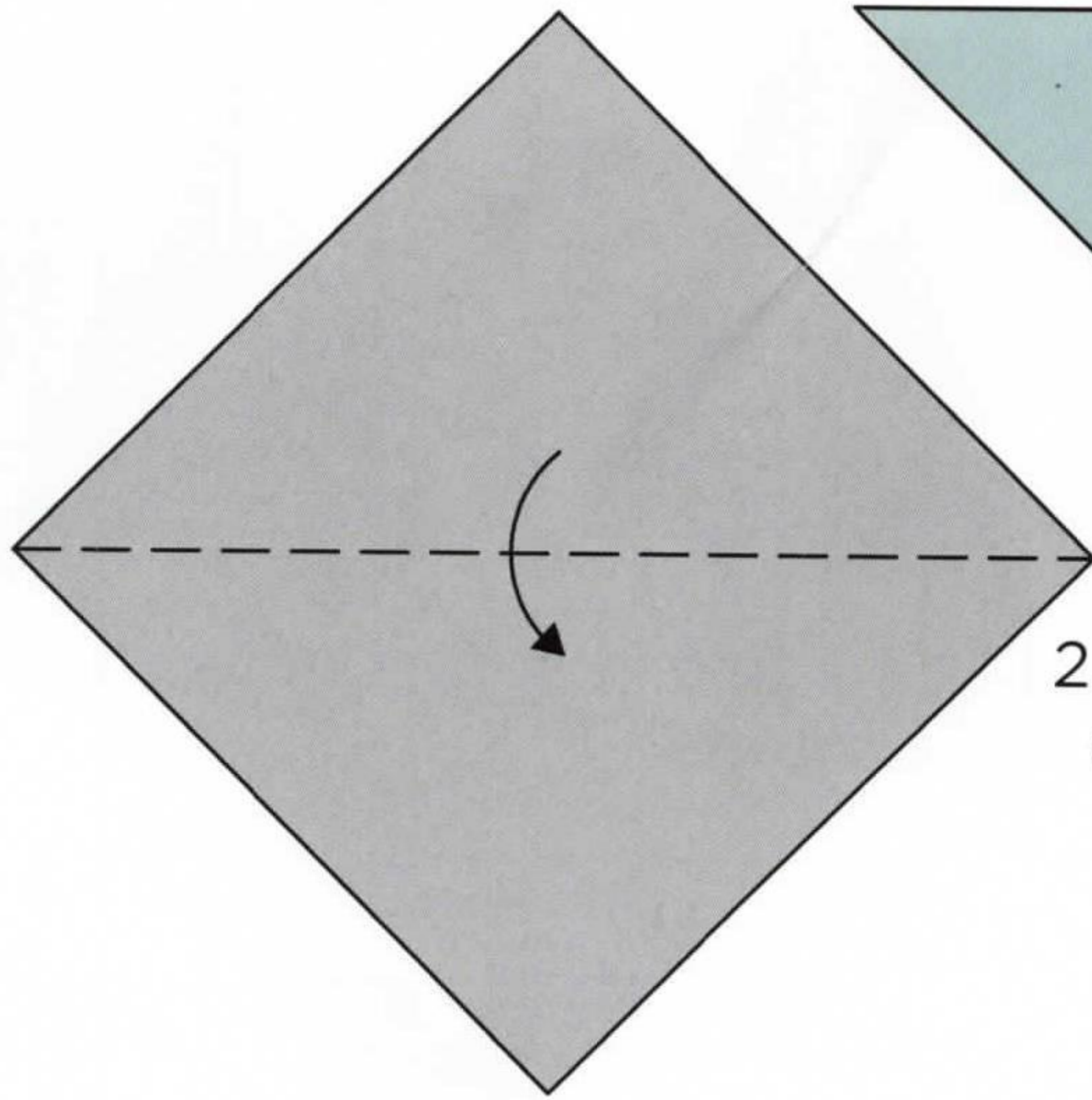

1. Valley fold

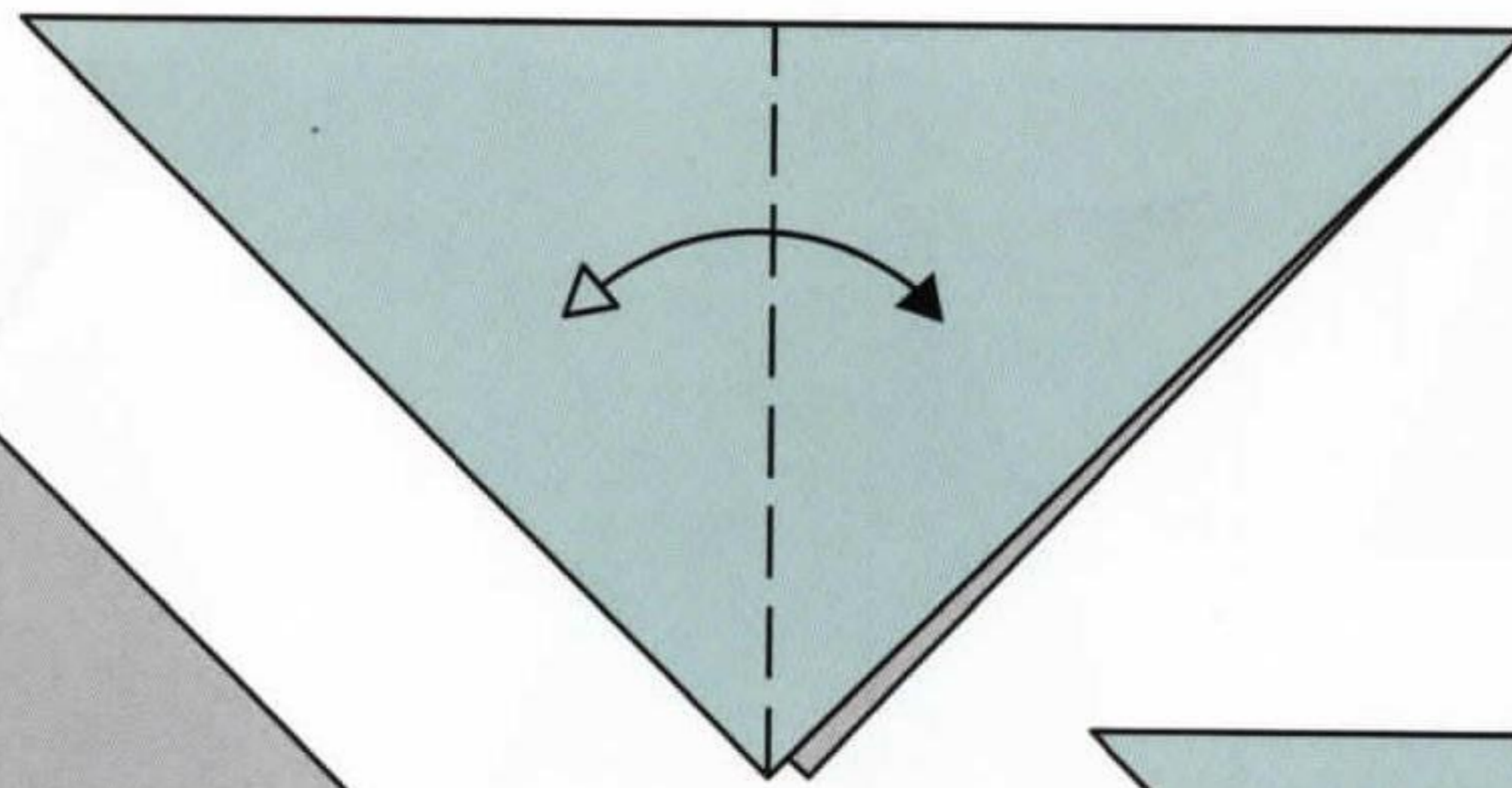

2. Valley fold and unfold

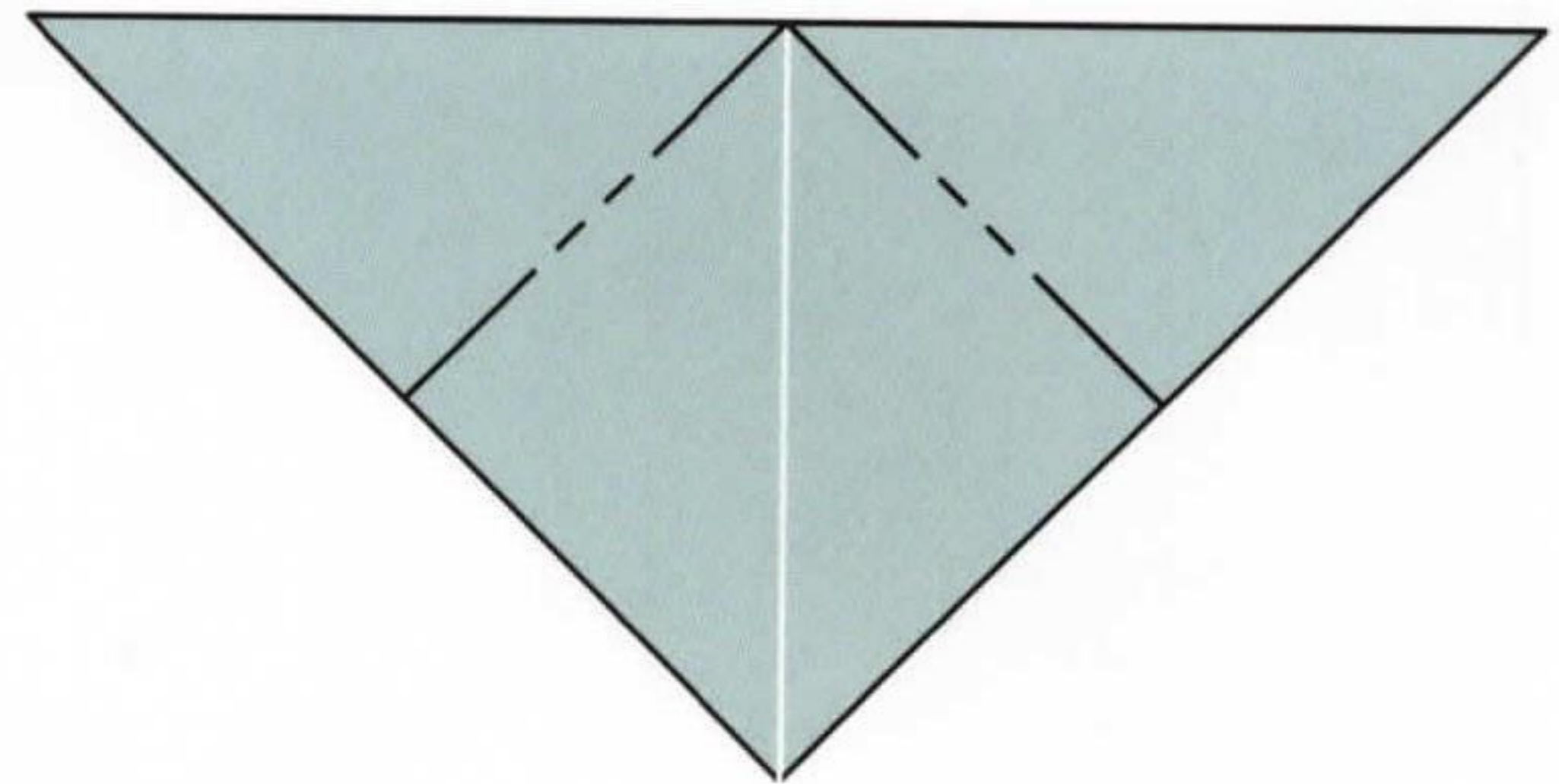

3. Inside reverse folds

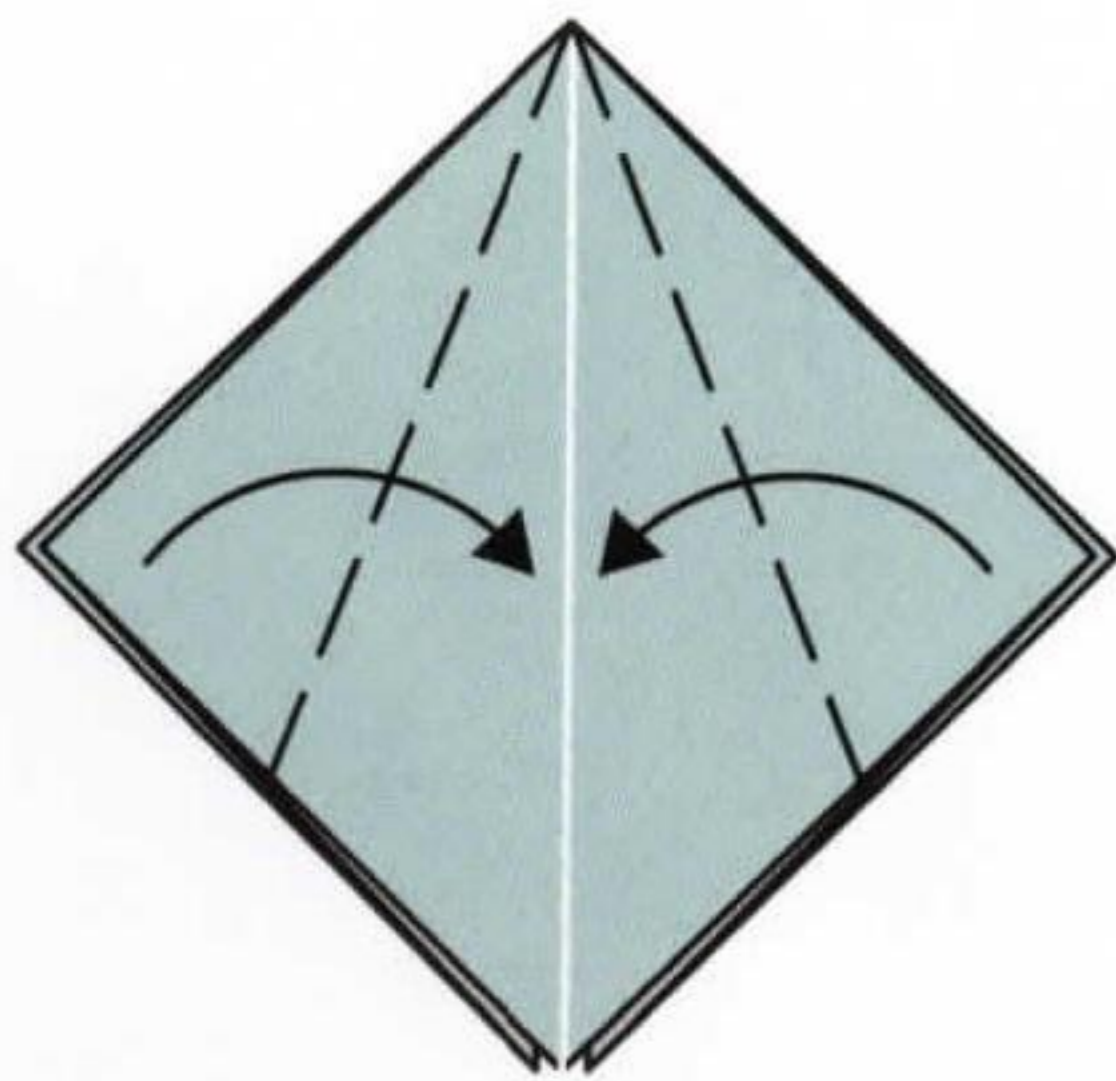

4. Valley folds

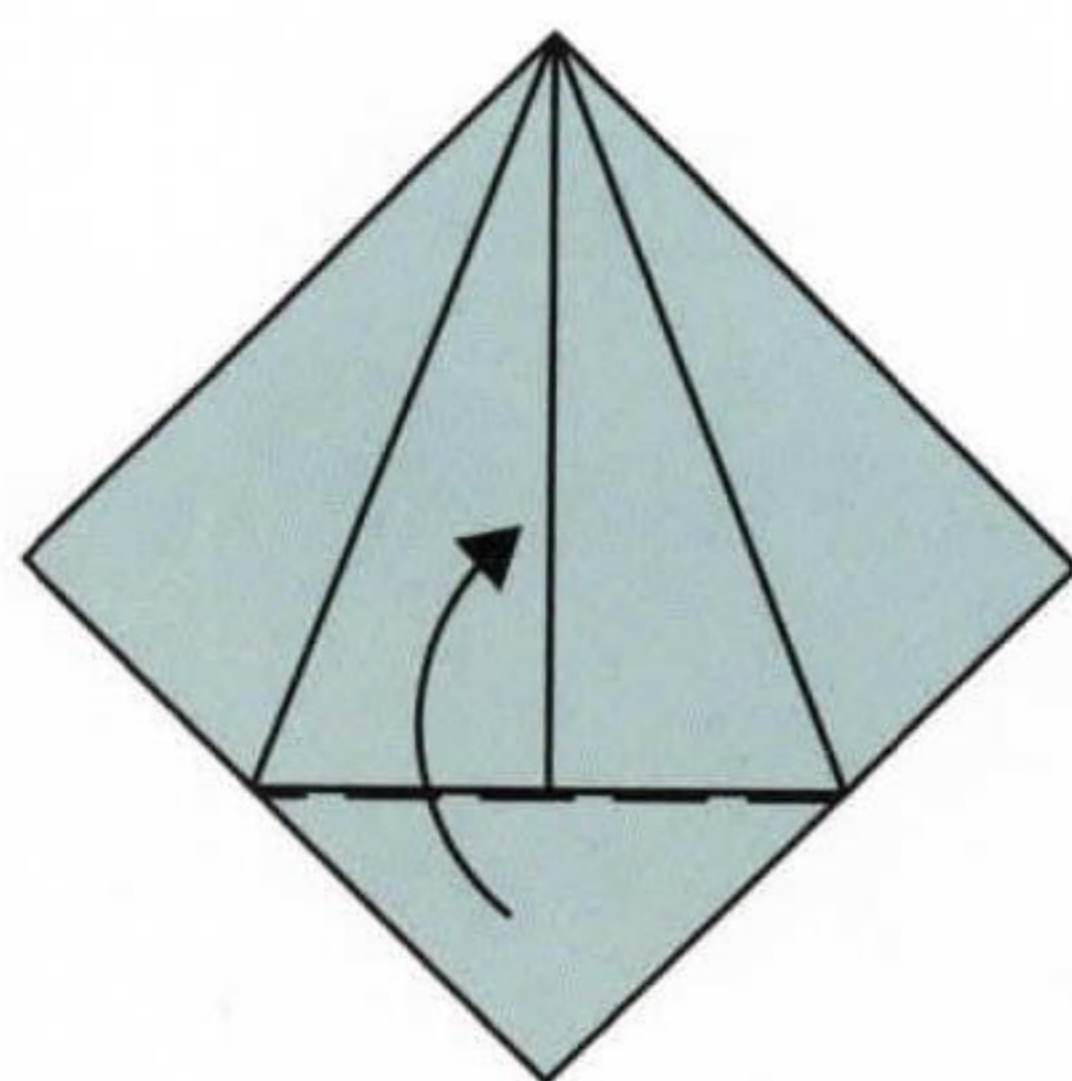

5. Valley fold

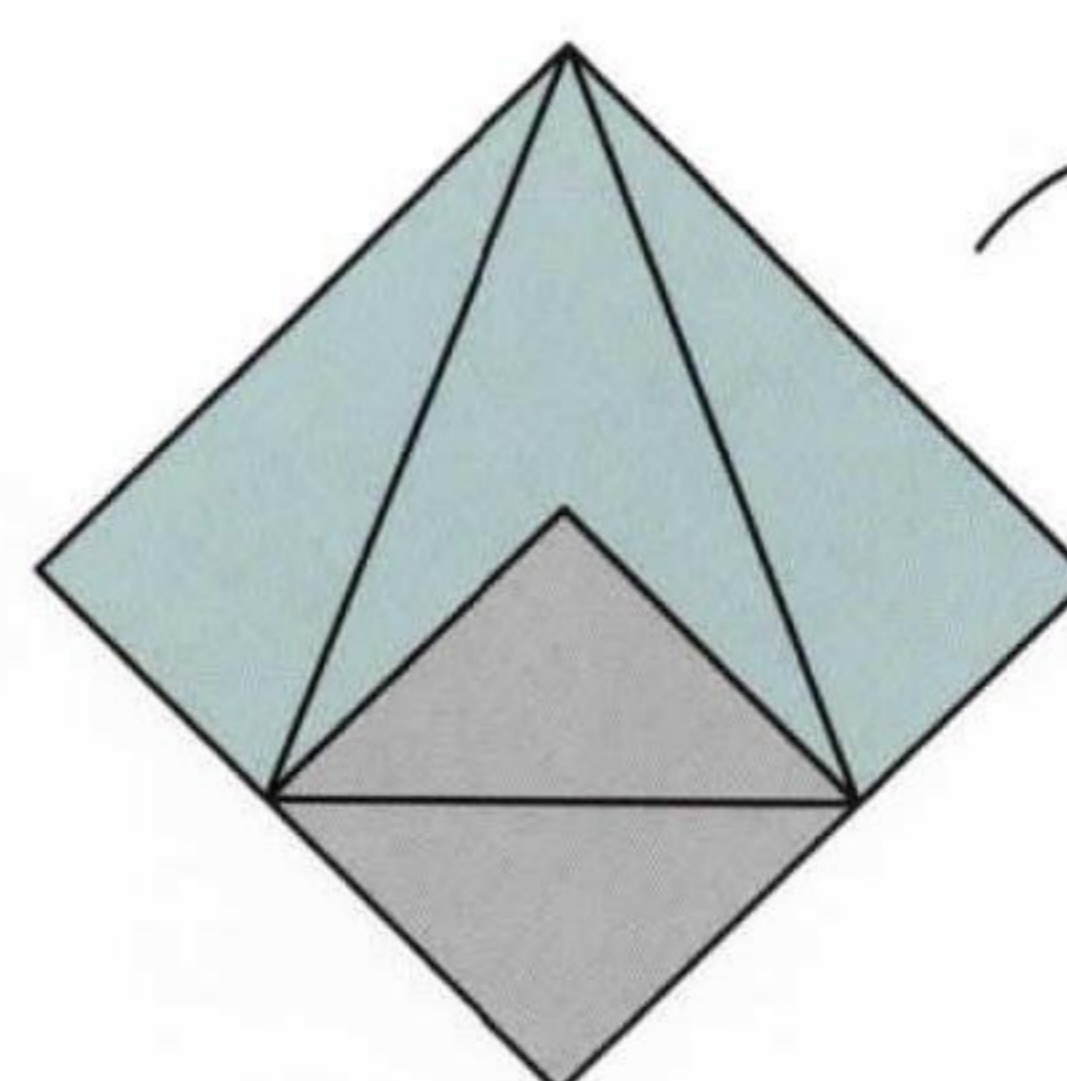

6. Turn over

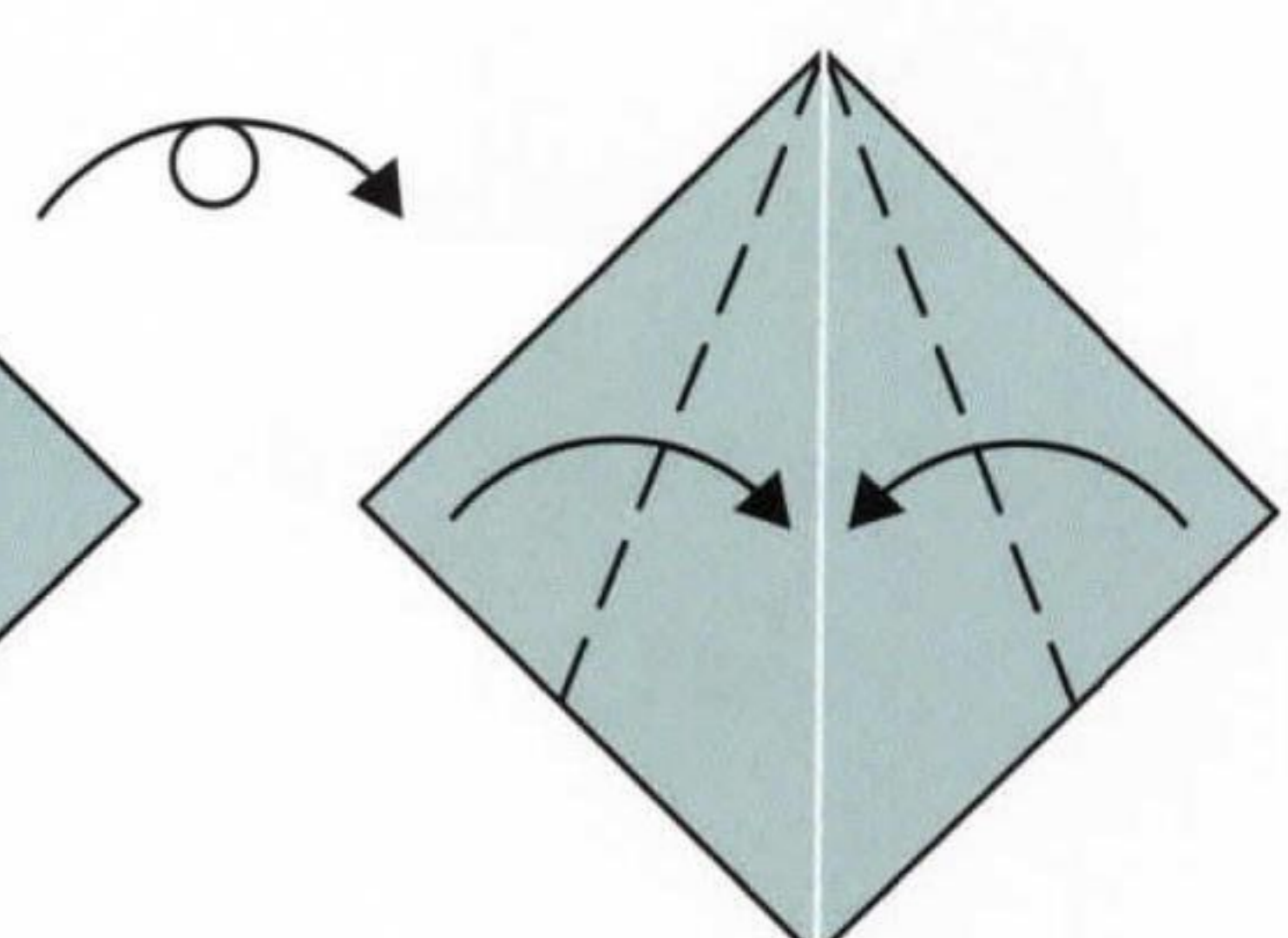

7. Valley folds

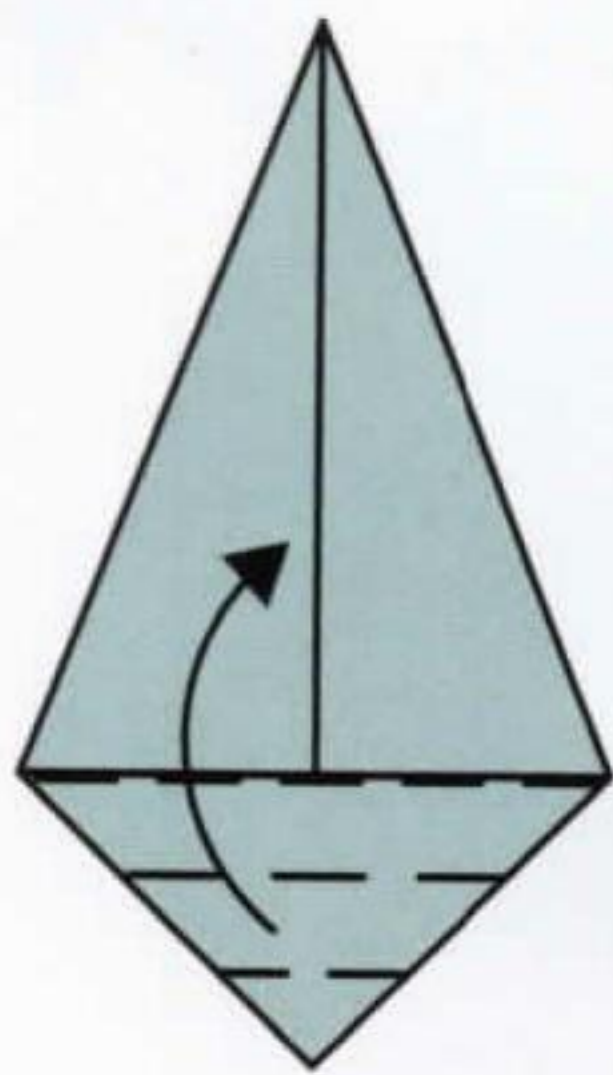

8. Valley folds

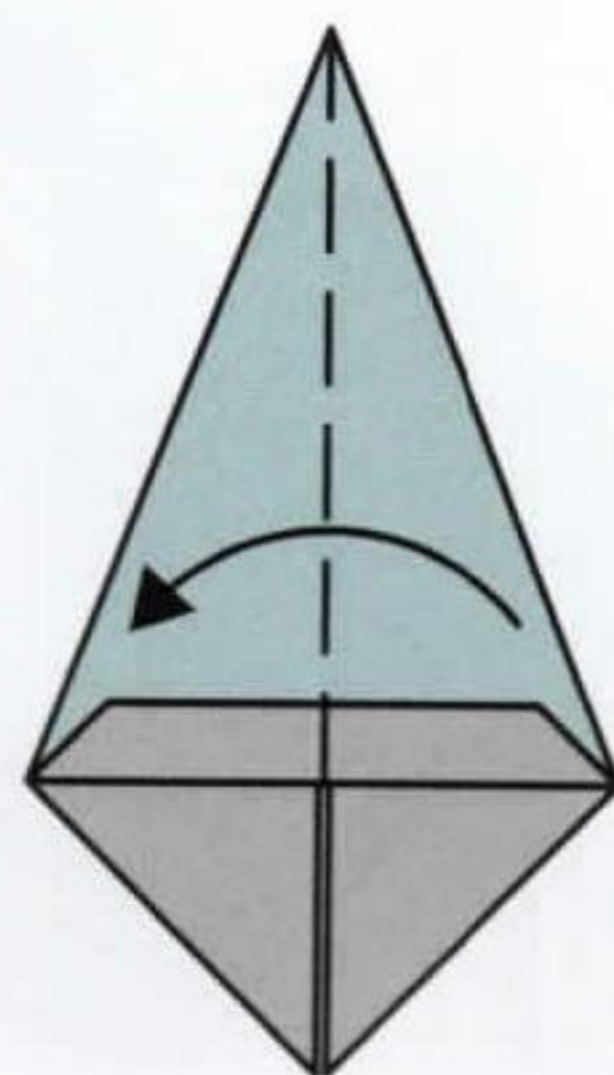

9. Valley fold

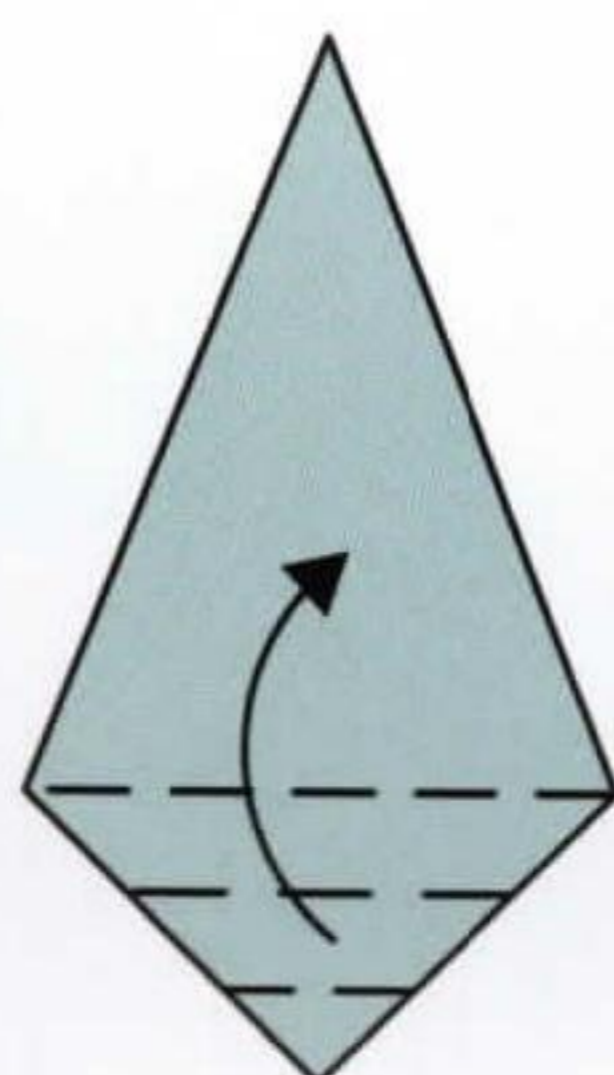

10. Valley folds

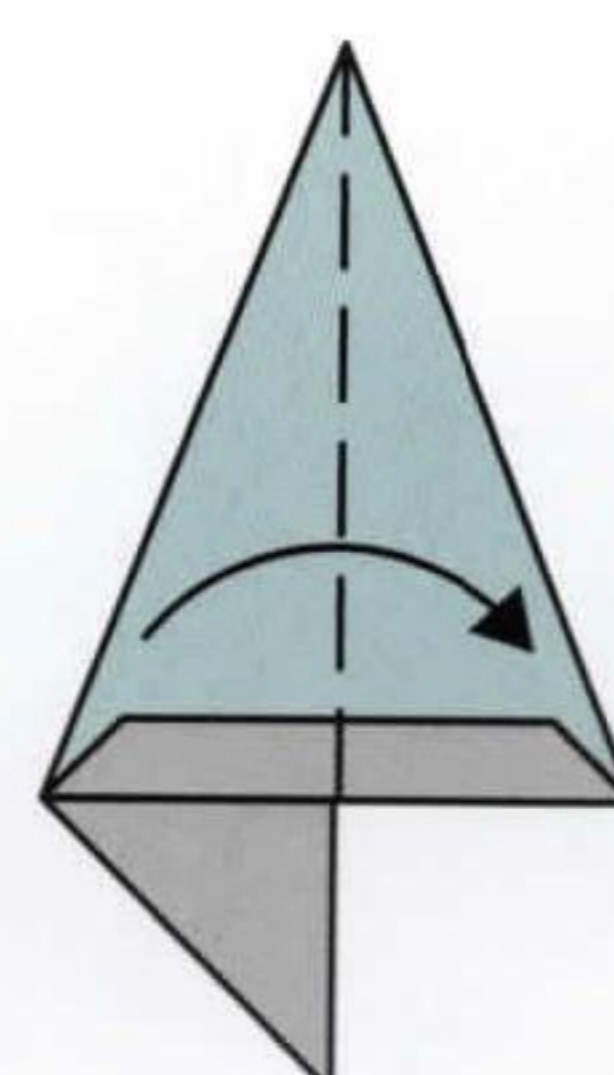

11. Valley fold

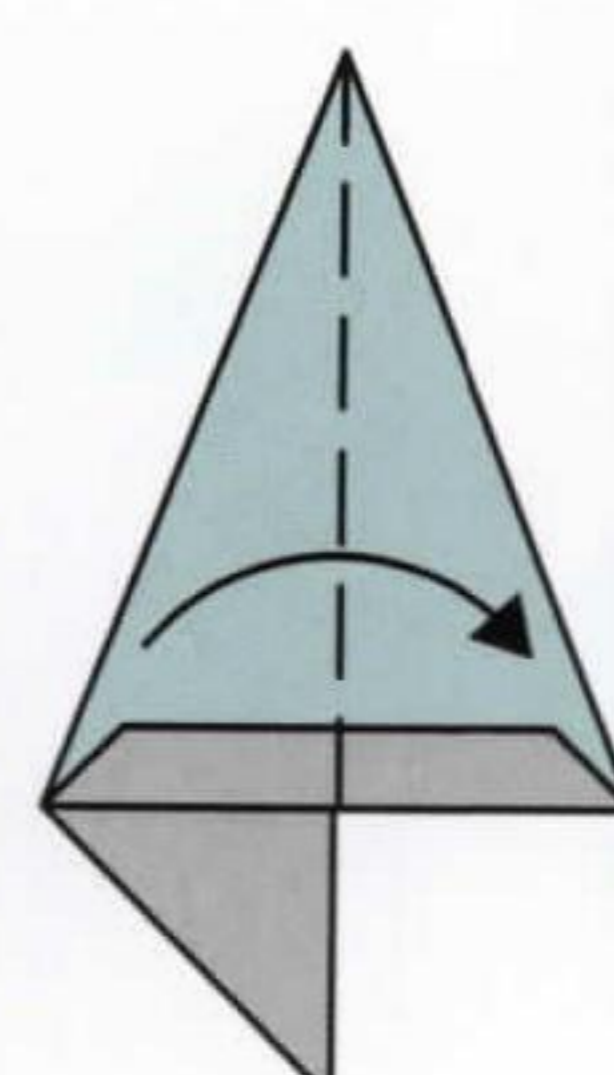

12. Valley fold

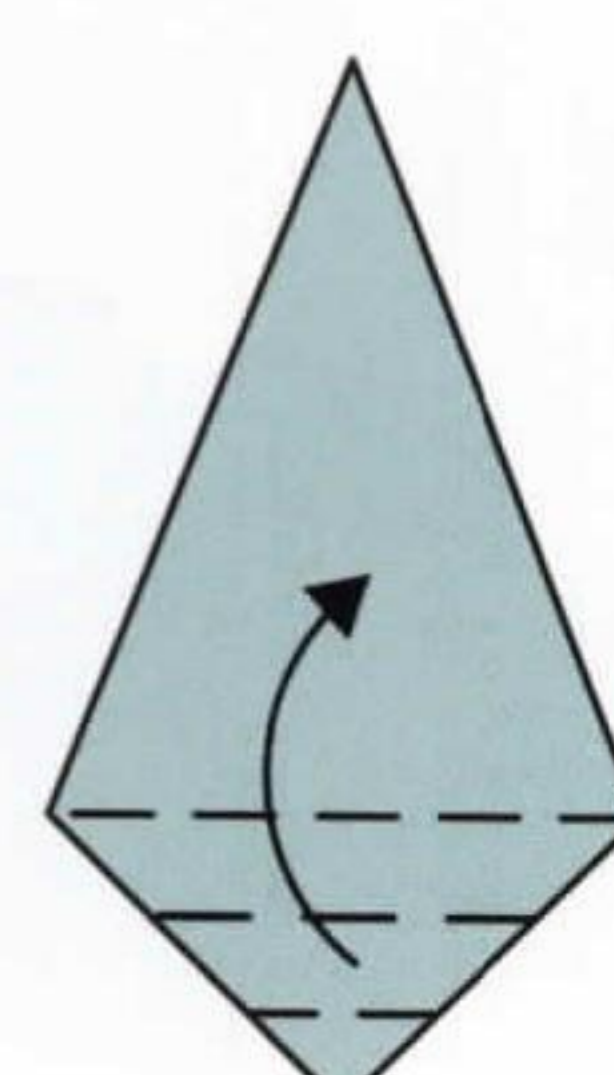

13. Valley folds

telephone: part 2

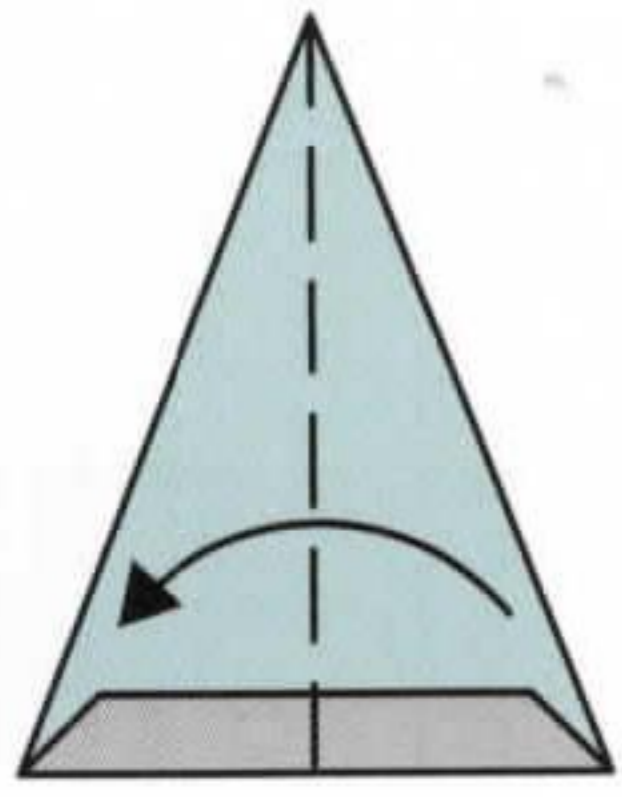

14. Valley fold

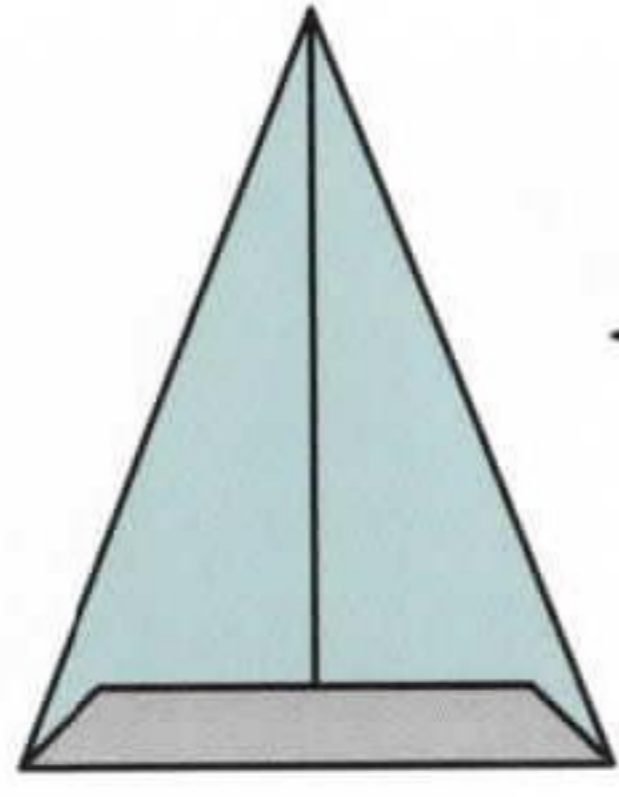

15. Scale-up

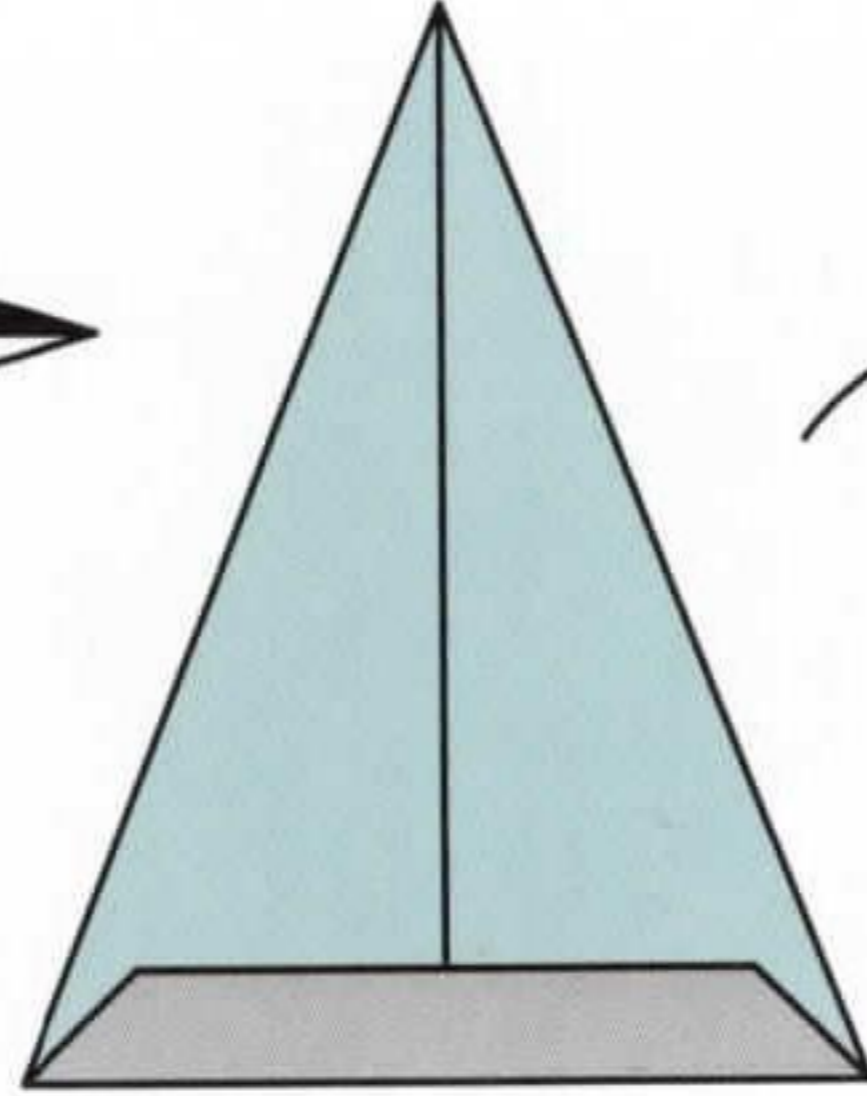

16. Turn over

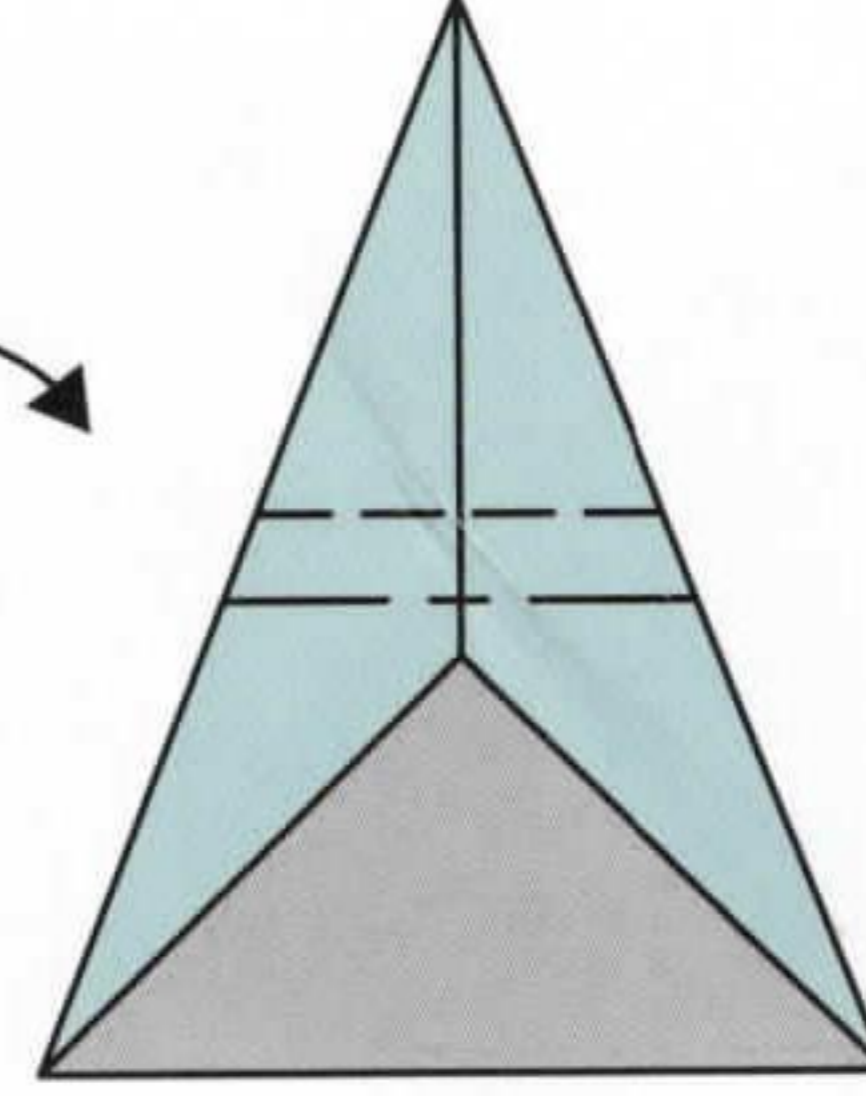

17. Sink fold in and out

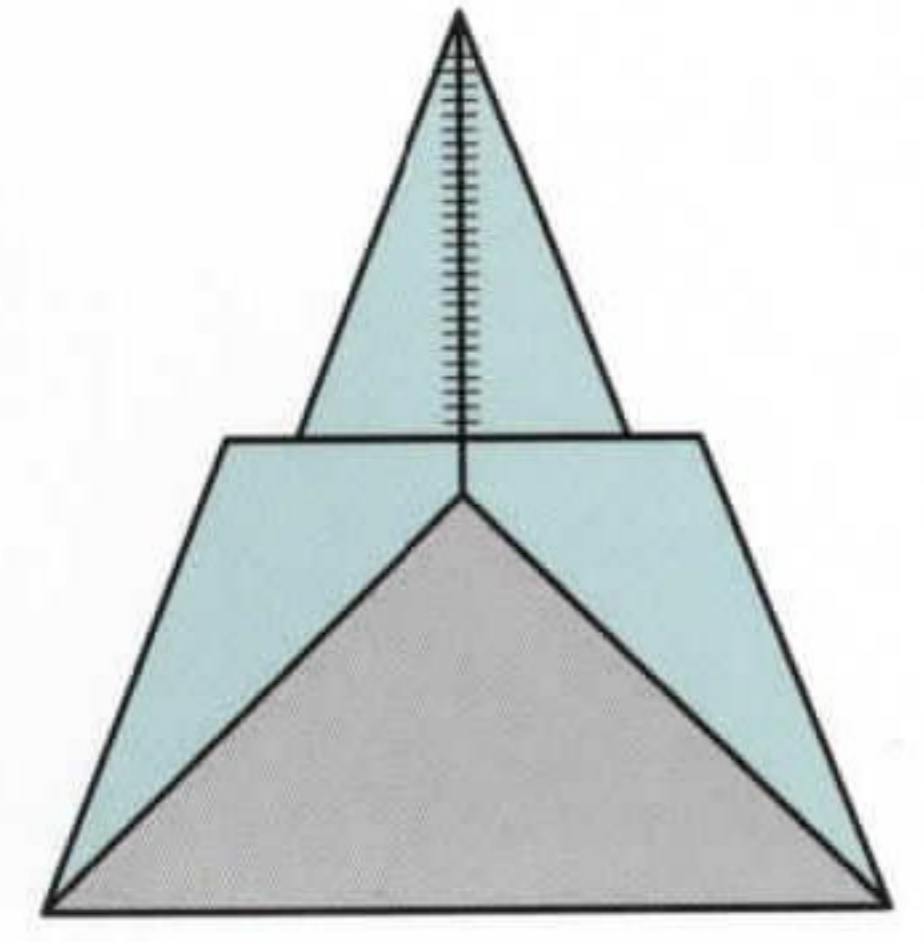

18. Cut as shown

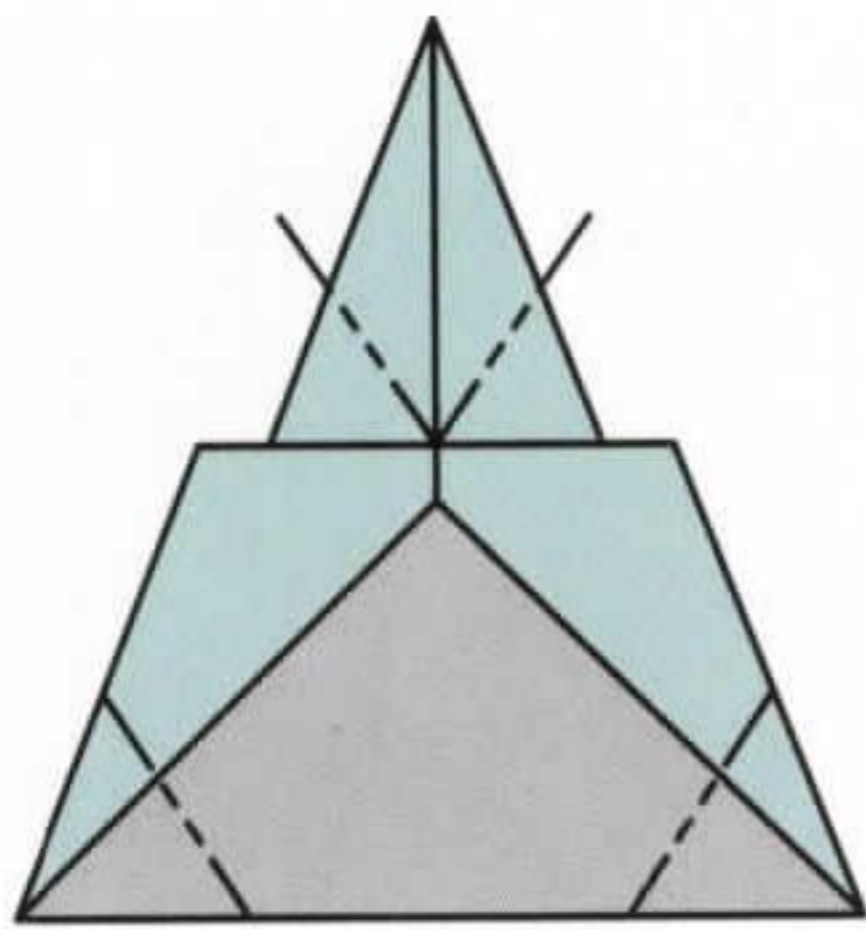

19. Inside reverse folds

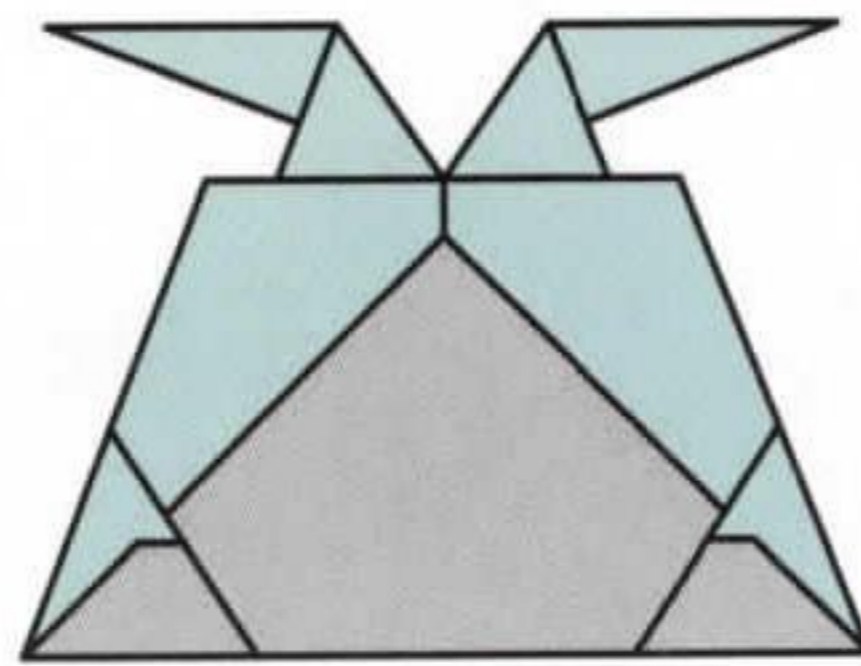

20. Turn over

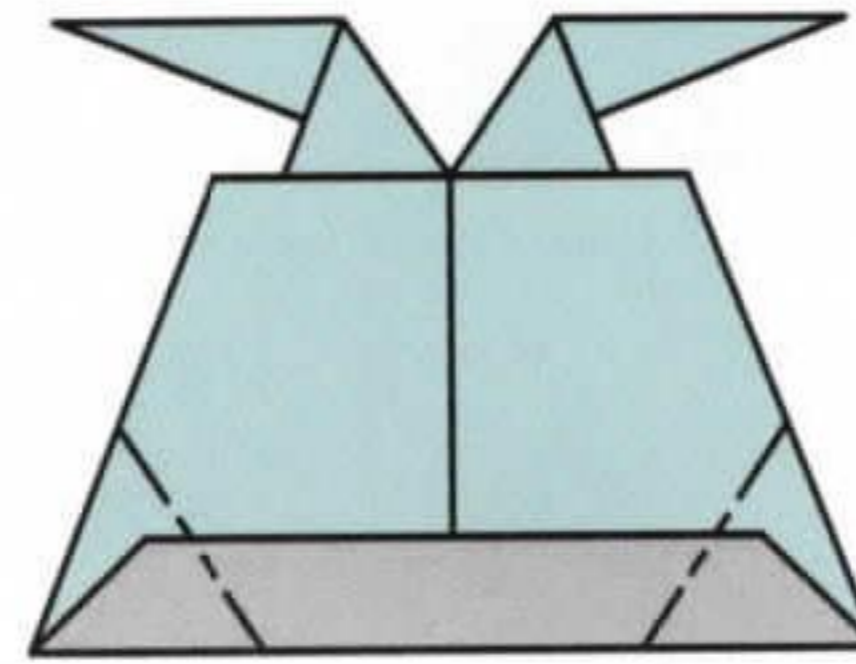

21. Inside reverse folds

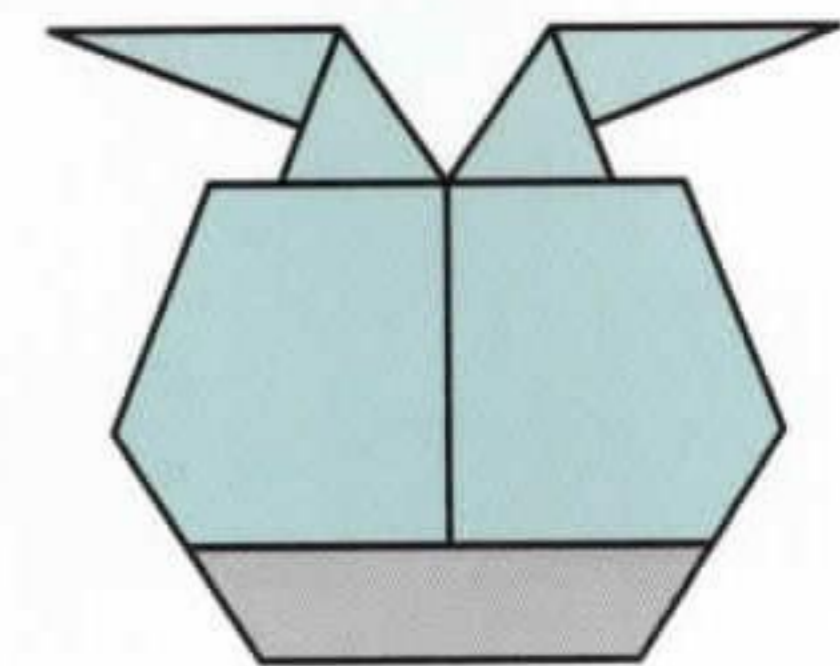

22. Turn over

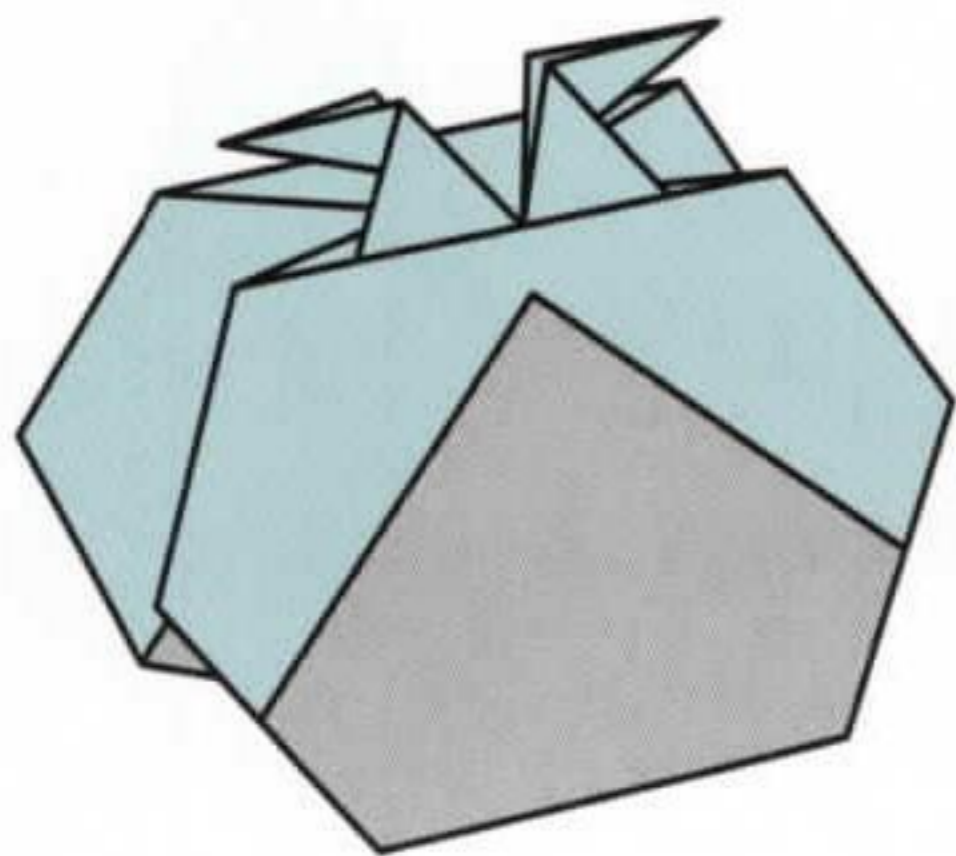
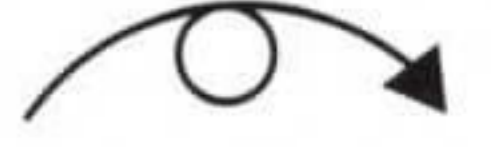

23. Completed PART 2

ASSEMBLY

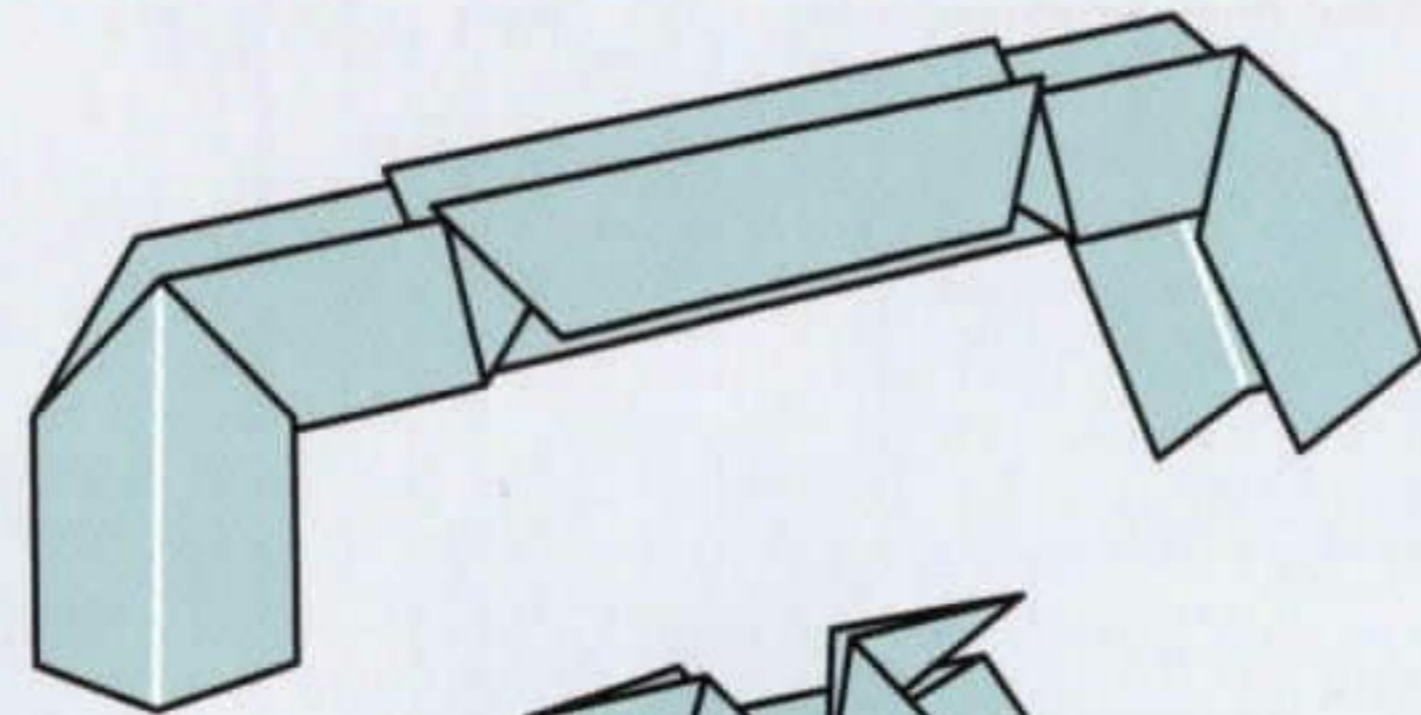

1. Join both parts together

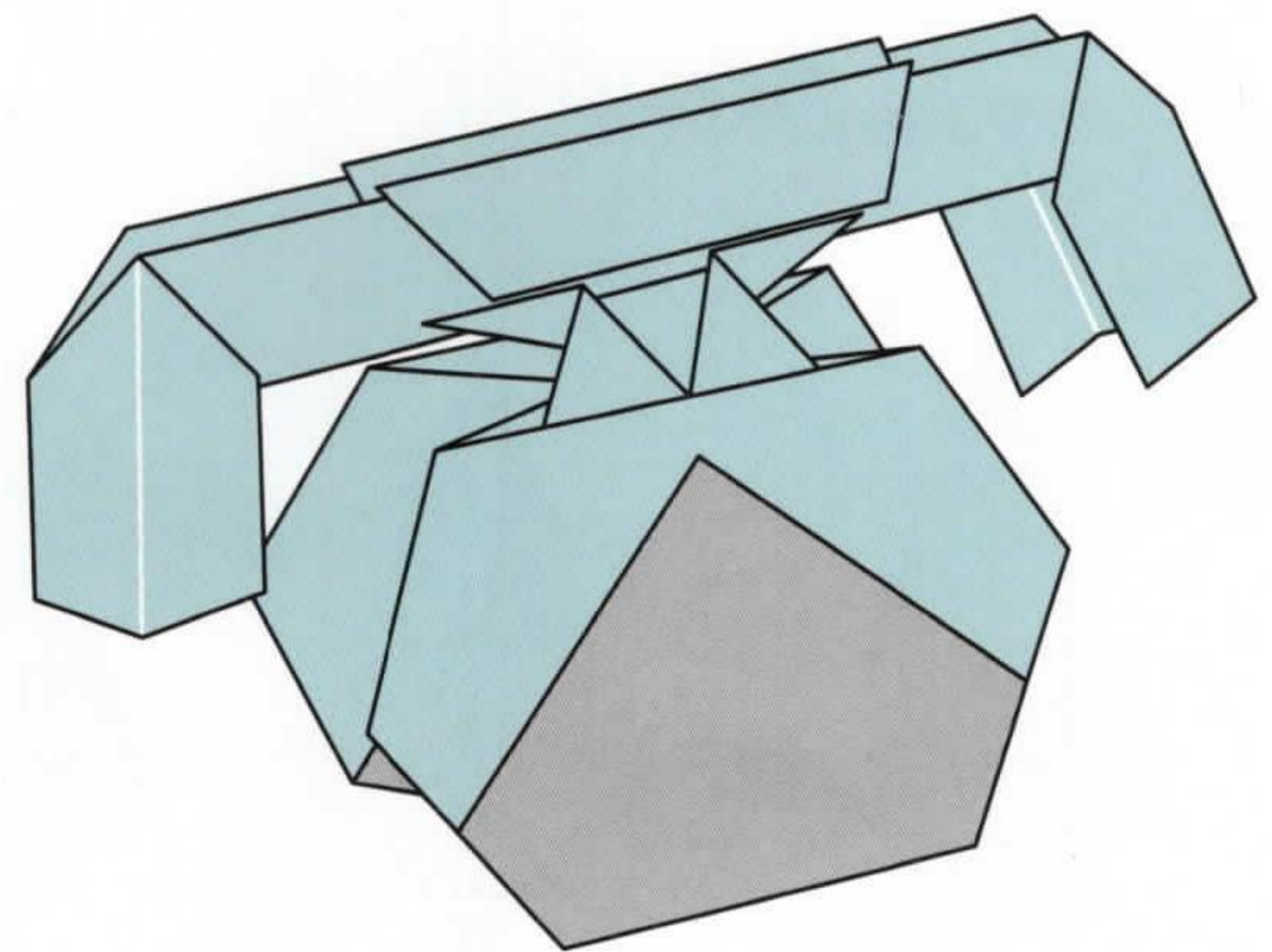

2. Completed TELEPHONE

CRAFTS & HOBBIES/
Origami

\$14

Fill your doll's house with stylish origami furniture

Origami master Duy Nguyen takes a fun, unique approach to furnishing different rooms in a doll's house, from the living room to the office and the bedroom to the bath. Using the traditional Japanese art form of paper folding, he shows you how to make fantastic miniature furniture and accessories. An introductory section will teach you the basic folds, while illustrated instructions show the folding sequences for the 25 imaginative paper projects, including a sofa, bookcase, computer, divan bed, television, lamp, bathtub, refrigerator, and more.

Cover design by David Ter-Avanesyan
Cover photographs: staircase © Douglas Free/Shutterstock

 **LARK**
LARKCRAFTS.COM

ISBN 978-1-4547-0906-0



9 781454 709060

5 1 4 9 5 >

Manufactured in China